

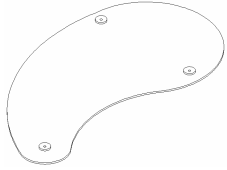

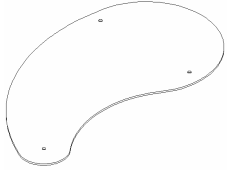



Assembly Instructions

Model CT-020

Components List

Part Name	Part Details			Qty
	Description	Specification	Figure	
T Glass	Glass for top shelf	Size: Thickness:		1
B Glass	Glass for bottom shelf	Size: Thickness:		1
TB	Tube	Length:148mm Diameter:50mm		3
F-T	Foot tube	Length:285mm Diameter:50mm		3
TES	Tube send seal	Diameter:50mm Thickness:2mm		6
I B-1	I bolt (NO.1)	Length:25mm Diameter:10mm		3
I B-2	I bolt (NO.2)	Length:50mm Diameter:10mm		3
TOOL	5# Tool (screw I bolts)			1

Assembly Instructions

Model CT-020

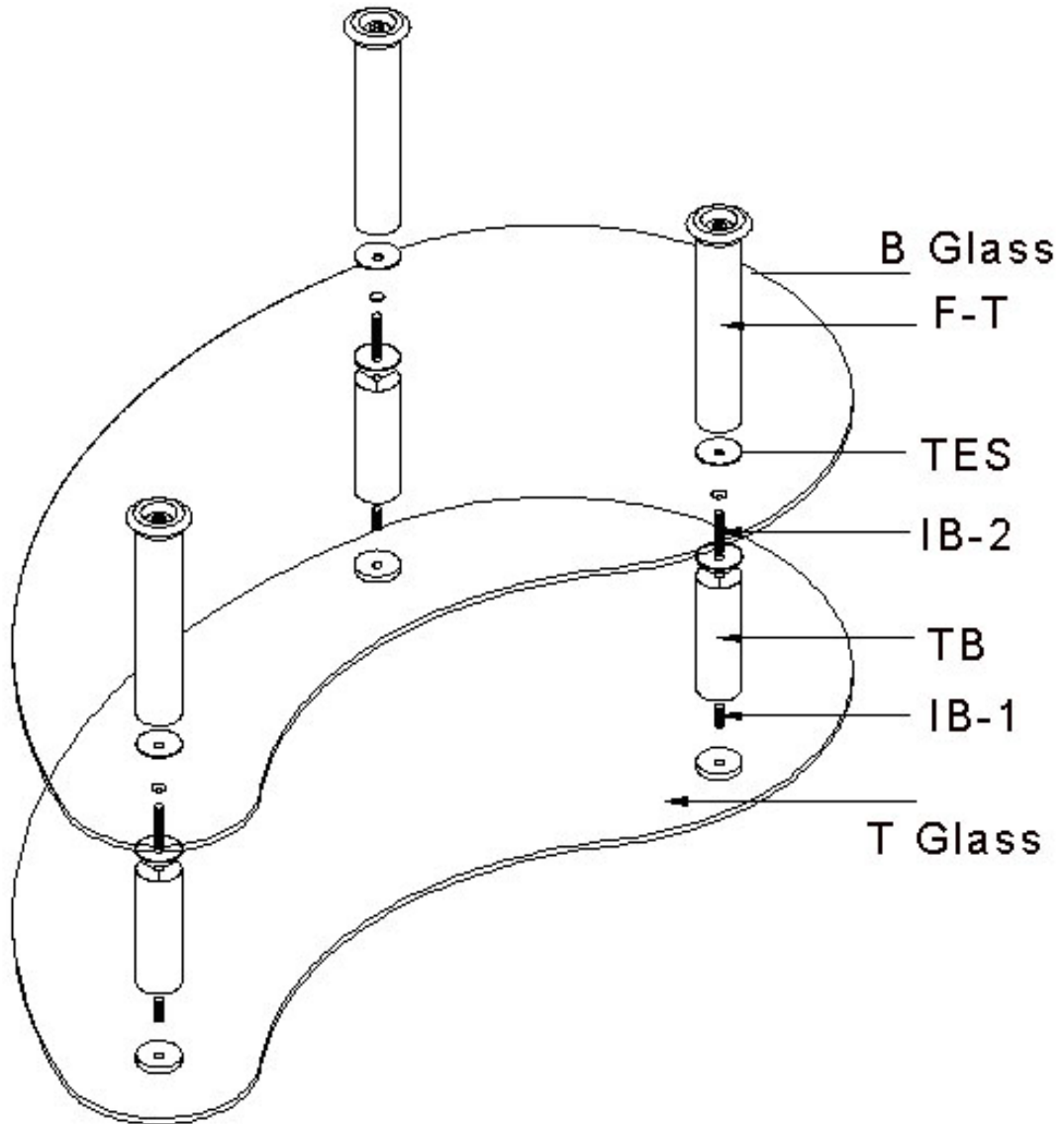

Model CT-020

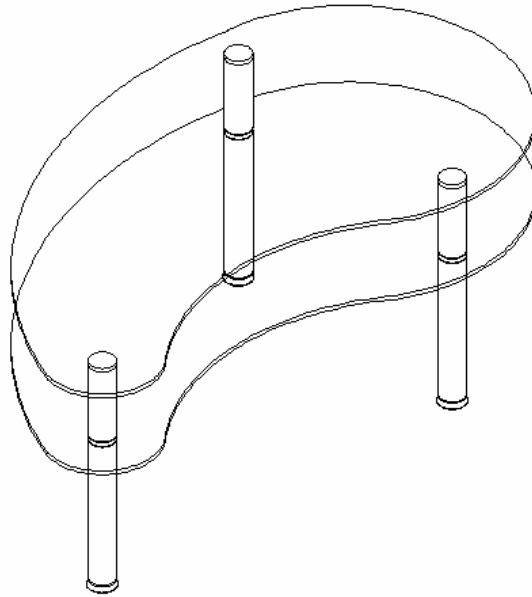

Stage 1

- 1.1 Screw in I bolts (I B-1) to chrome caps (CC) on the top glass (T Glass).
- 1.2 Screw tubes (TB) onto each exposed bolt until tight.

Stage 2

- 2.1 Screw in I bolts (I B-2) to top of each tube.
- 2.2 Place bottom glass (B Glass) over I bolts resting on tubes.

Stage 3

- 3.1 Screw foot tubes (F-T) onto each exposed bolt until tight.

