

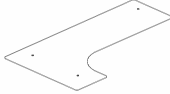

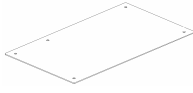

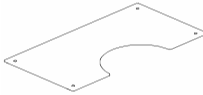





Assembly Instructions

Page 1/4

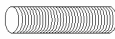
Model CUT-106

Components List

Part Name	Part Description		Qty
T Glass	Glass for top or bottom shelves		1
M Glass	Glass for middle shelf		1
B Glass	Glass for Bottom shelf		1
T-1	Tube (No.1)		3
T-2	Tube (No.2)		4
T-3	Tube (No.3)		4
t-4	Tube(No.4)		4
CC-L	Chrome Cap (large)		4
CC-S	Chrome Cap (small)		4
I B-1	I bolt (NO.1)		4
I B-2	I bolt(NO.2)		7
T E S	Tube end seal (already fitted to tubes)		18
TOOL-1	5# Tool (screw I bolt)		1

Assembly Instructions

Model CUT-106

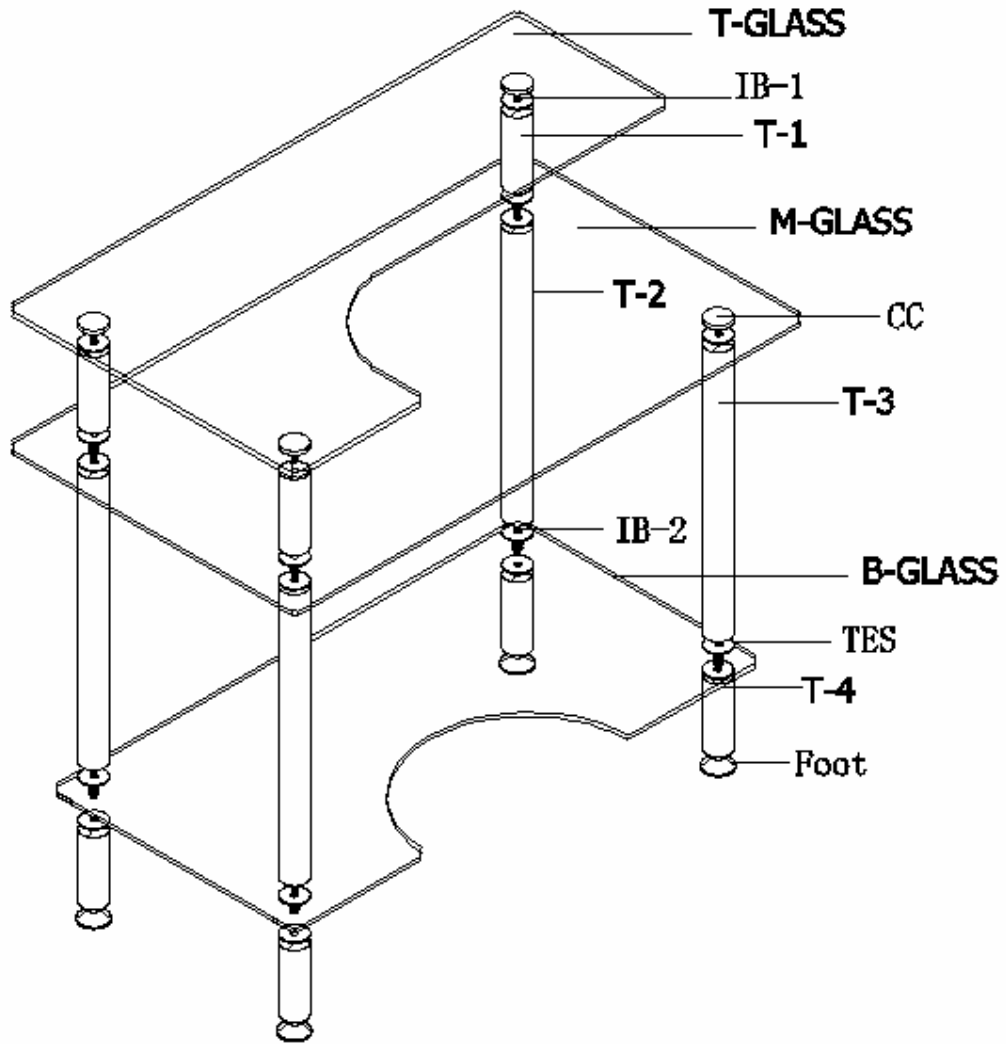

Model CUT-060

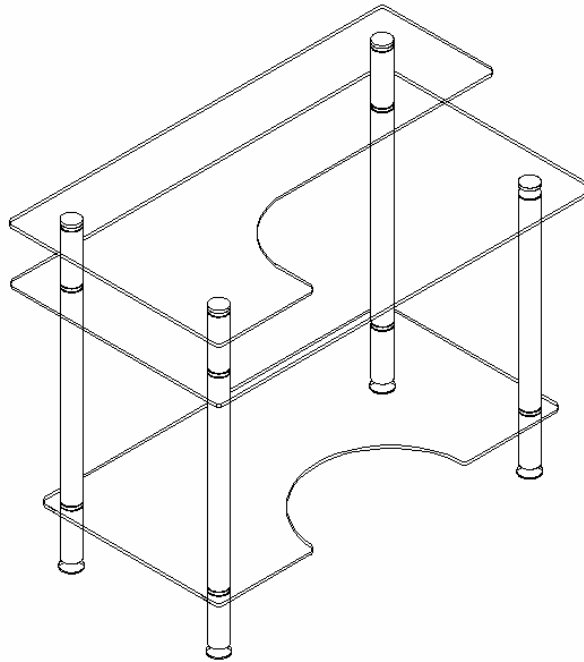

Stage 1

Please note stand is best assembled from the bottom up.

- 1.1 Screw in I bolts(I B-2) to the top of each foot tube(T-1).
- 1.2 Place bottom shelf(TB Glass) in position over each foot tube leg with I bolts passing through holes in each corner of the shelf. Then screw tubes(T-2) onto each exposed bolt until tight.
- 1.3 Screw in I bolts(I B-2) to the top of each tube(T-2).

Stage 2

- 2.1 Place middle shelf (M Glass) in position over each long tube leg with I bolts passing through holes in each corner of the shelf. Then screw tubes(T-3) onto I bolts until tight.

Repeat the same stage to assemble other middle glasses and top glass.

Stage 3

- 3.1 Attach cable tidy to top glass and bottom glass with small chrome cap (CC-S)- screw I bolts(I B-3) to small chrome cap then screw I bolts through the cable tidy nuts.

3.2 Secure top glass with large chrome caps(CC-L)

