

Combi[®]

Kobuk[™] Booster Car Seat

Over 3 years old and 33 to 100 lbs. (15 to 45 kg)

Instruction Manual



***High Back
Booster Car Seat***

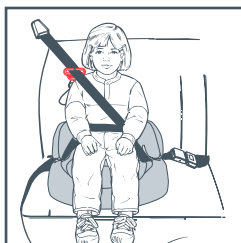

Booster Car Seat

Kobuk[™] 8970 Series

⚠ WARNING ⚠

Correct installation and use can be a matter of Life or Death! Read and understand these instructions before using this car seat.

- Certified for use in motor vehicles.
- Meets or exceeds all applicable requirements of Federal Motor Vehicle Safety Standard 213.

Para instrucciones en Español,
llamar al: 1-800-992-6624.

Section 1 - Warnings

WARNING **DEATH or SERIOUS INJURY can occur**

- Failure to follow these instructions and car seat labels can result in injury or death to a child from striking the vehicle's interior during a sudden stop or crash.
- Use only with children who are at least 3 years old, weigh between 33 and 100 lbs. (15 and 45 kg) and whose height is between 33 and 57 inches (84 and 145 cm).
- Snugly adjust the vehicle lap and shoulder belt around child according to the instructions in the vehicle owner's manual.
 - Vehicle lap belt **MUST** be positioned low on the hips contacting the thighs.
 - Shoulder belt must be properly positioned over shoulder (NOT touching child's neck and NOT off shoulder).
 - Never use shoulder belt loose, positioned under child's arms, or behind child.
 - A snug belt should not allow any slack. It lies in a relatively straight line without sagging. It does not press on the child's flesh or push the child's body into an unnatural position.

Section 1 - Warnings - continued

WARNING **DEATH or SERIOUS INJURY can occur**

- Use only the vehicle's lap and shoulder belt system when restraining the child in this Booster Car Seat. Lap belt **MUST** be under armrests.
- Never use Booster Car Seat with only a vehicle lap belt across front of child. Use with only a lap belt could result in serious injury or death to a child.
- Not all vehicle seat belts can be used with this Booster Car Seat. Read vehicle owner's manual and "Vehicle Seat Belt Systems" section in this manual.
- Never use this Booster Car Seat with the vehicle's LATCH System.
- Never use Booster Car Seat in a front vehicle seat location unless recommended by vehicle owner's manual.
- To avoid injury, this restraint should be installed and adjusted by an adult. **NEVER** allow child to buckle themselves in this Booster Car Seat.
- Discontinue use of the Booster Car Seat when the top of the child's ears are above top of the seat back or headrest. Severe head or neck injuries could result without proper head support.

Section 1 - Warnings - continued

WARNING **DEATH or SERIOUS INJURY can occur**

- Do not allow child to slide down in Booster Car Seat which could position vehicle lap belt across child's abdomen and shoulder belt over neck or face.
- Vehicle belts **MUST** lay flat against child and **MUST** not be twisted.
- If child will not keep vehicle shoulder belt properly positioned, **DO NOT** use this Booster Car Seat. Use a different child restraint system.
- Secure this child restraint to the vehicle, even when not occupied. Unsecured items may injure other occupants in a crash.
- **DO NOT** use accessories or parts other than those provided by Combi Select or Combi USA. Use of accessories or parts from other manufacturers could alter the performance of the car seat.
- **DO NOT** allow any re-use of this car seat after a crash unless crash and car seat meet **ALL** conditions in "Re-use After A Crash" section of this manual.
- **DO NOT** use Booster Car Seat if it is damaged, missing instructions, or missing parts.
- Register your child restraint with the manufacturer.

Section 2 - Table of Contents

Section 1. Warnings.....	1
Section 2. Table of Contents.....	4
Section 3. Proper Use Check List.....	5
Section 4. Kobuk™ Booster Car Seat Parts.....	7
Section 5. Use Recommendations.....	9
Section 6. Selecting A Vehicle Seating Location.....	11
• Vehicle Seat Belt Systems.....	13
Section 7. High Back Booster Car Seat Use.....	15
Section 8. Booster Car Seat Use (Without Seat Back).....	19
Section 9. Seat Back Assembly.....	24
Section 10. Additional Information	
• Certification.....	25
• Aircraft Use.....	25
• Warm Weather.....	25
• Vehicle Seat Protection.....	25
• Instruction Manual Storage.....	25
• Car Seat Useful Life.....	25
Section 11. Care and Cleaning.....	26
Section 12. Re-Use After A Crash.....	27
Section 13. Registration Information.....	28
Section 14. Limited Warranty.....	29

Keep this instruction manual for future use.
Store under seat base.

Section 3 - Proper Use Check List

- Proper use is required. Read and understand instructions and car seat labels.
- Secure child in this child restraint with a vehicle lap and shoulder belt as specified in this instruction manual.
- Snugly adjust vehicle lap and shoulder belt around child. Lap belt **MUST** be under armrests.
- A vehicle combination lap and shoulder belt **MUST** be used when using Booster Car Seat.
- Do not use only a vehicle lap belt with this Booster Car Seat.
- Secure children in back seat whenever possible.
- Never leave child unattended.
- Do not allow anyone (babysitter, relatives, etc.) to use Booster Car Seat without first reading and understanding all instructions and car seat labels.

Section 3 - Proper Use Check List - continued

Need help installing your Booster Car Seat?

Contact Combi Consumer Affairs Department or one of the following sources:

- Your vehicle dealer to locate a child safety seat inspection station in your area.
- Call 1-866-SEAT CHECK (1-866-732-8243).
- Visit www.nhtsa.dot.gov and select “Locate a Child Safety Seat Inspection Station by State or Zip”.
- Visit www.seatcheck.org.
- Contact a certified child passenger safety technician in your area. To locate a certified “Child Passenger Safety” Technician in your area visit www.nhtsa.dot.gov, select “Vehicles & Equipment” tab, select “Child Seats” topic and then select “Child Passenger Safety Contact Locator” or “Child Safety Seat Inspection Station Locator”.

Proper Use Is Required:

No car seat can guarantee protection from injury in every situation, but proper use helps reduce the risk of serious injury or death.

Section 4 - Kobuk™ Booster Car Seat Parts

HIGH BACK BOOSTER CAR SEAT

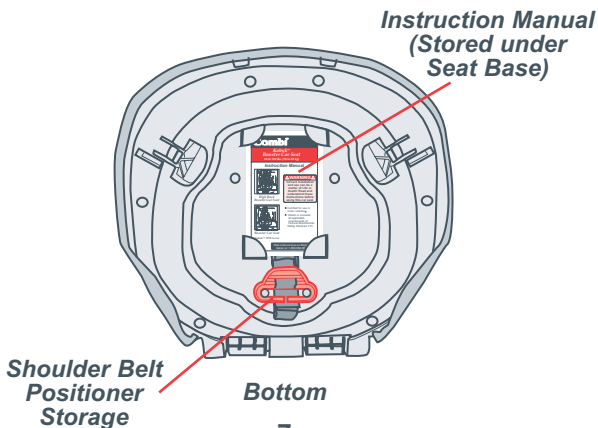
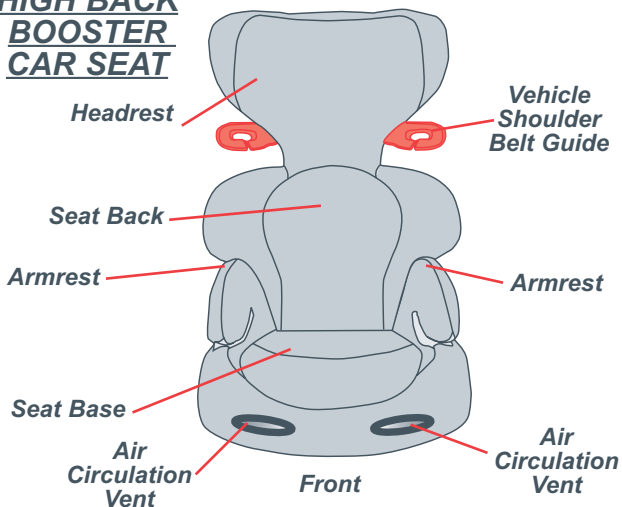

Section 4 - Kobuk™ Booster Car Seat Parts - continued

HIGH BACK BOOSTER CAR SEAT

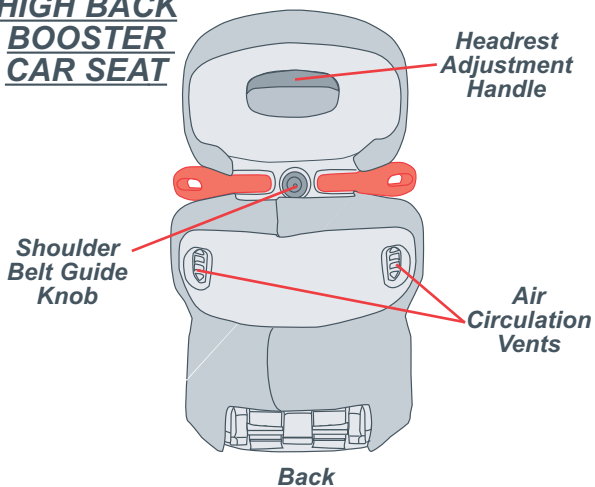

BOOSTER CAR SEAT (WITHOUT SEAT BACK)

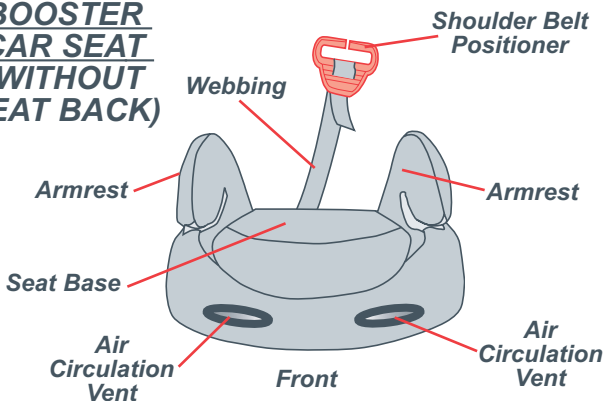

Section 5 - Use Recommendations

Height and Weight Limits:

This child restraint is designed for use only by children who are at least 3 years old, weigh between 33 and 100 pounds (15 and 45 kg) and whose height is between 33 and 57 inches (84 and 145 cm).

This child restraint can be used as a forward-facing booster car seat with or without the seat back. The booster car seat should be used with the seat back as long as possible before removing the seat back and using the seat base only.

HIGH BACK BOOSTER CAR SEAT USE:

Child *MUST* meet all of the following requirements:

- Child *MUST* be at least 3 years old and
- Child weight is between 33 and 100 pounds (15 and 45 kg) and
- Child's height is between 33 and 57 inches (84 and 145 cm) and
- Top of child's ears are below top of seat back.



Section 5 - Use Recommendations - continued

BOOSTER CAR SEAT (WITHOUT SEAT BACK) USE:

Child *MUST* meet all of the following requirements:

- Child *MUST* be at least 3 years old and
- Child's weight is between 33 and 100 pounds (15 and 45 kg) and
- Child's height is between 33 and 57 inches (84 and 145 cm) and
- Top of child's ears are below top edge of vehicle seat back or headrest.

NOTE: If top of child's ears are below top of vehicle seat, use Booster Car Seat back provided top of ears are below top of Booster Car Seat Back.



⚠ WARNING ⚠
DEATH or SERIOUS INJURY can occur

- Discontinue use of the Booster Car Seat if top of child's ears are above the top edge of seat back or headrest. Severe head or neck injuries could result without the proper head support.

Section 6 - Selecting A Vehicle Seating Location

- 1 National Highway Traffic Safety Administration (NHTSA) alerts vehicle owners that according to accident statistics, children up to age 12 are safer when properly restrained in rear seating positions rather than front seating positions.
- 2 Refer to vehicle owner's manual for car seat installation instructions for your vehicle.
 - Use car seat in a rear vehicle seat location whenever possible.
 - Never put a car seat in a front seat location unless recommended by vehicle owner's manual.
 - For vehicles with air bags, always follow child restraint installation information provided in vehicle owner's manual.

	<p>DO NOT place rear-facing child seat on front seat with air bag. DEATH OR SERIOUS INJURY can occur.</p> <p>The back seat is the safest place for children 12 and under.</p>	WARNING
<p>NO coloque el asiento infantil para el automóvil orientado hacia atrás en el asiento delantero del vehículo que tenga una bolsa neumática de seguridad. El niño podría MORIR O SUFRIR LESIONES GRAVES. El asiento trasero es el lugar más seguro para los niños de 12 años o menores.</p>		

If a vehicle front seat location with an air bag must be used, follow the vehicle manufacturer's instructions for child restraint use and move the vehicle seat back as far as possible.

Section 6 - Selecting A Vehicle Seating Location - continued

3 DO NOT use this Booster Car Seat with the vehicle's Child Restraint Anchorage System or LATCH System.

4 Vehicle seats:

DO NOT use this Booster Car Seat on the following types of vehicle seats:



***Seats Which Face
Sides Of Vehicle***



***Seats Which Face
Rear Of Vehicle***

Vehicle Seat Belt Systems

Design and operation of vehicle seat belt systems vary from vehicle to vehicle and from seating location to seating location in the same vehicle. Refer to the vehicle owner's manual for instructions on proper use, placement and adjustment of the vehicle lap and shoulder belt.

Not all vehicle seat belts can be used with a child restraint. Refer to this section for information on the various types of vehicle seat belt systems.

⚠ WARNING ⚠
DEATH or SERIOUS INJURY can occur

- **Use only the vehicle's lap and shoulder belt system when restraining the child in this Booster Car Seat.**
- **Never use the Booster Car Seat with only a vehicle lap belt.**
- **Do not allow child to slide down in Booster Car Seat which could position vehicle lap belt across child's abdomen and shoulder belt over neck or face.**

Vehicle Seat Belt Systems - continued

DO NOT use this Booster Car Seat with the following types of vehicle seat belts:

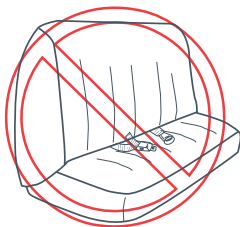

Lap Belt Only

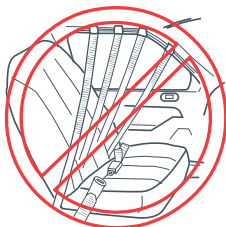

***Passive Restraints
Motorized
Shoulder Belt***

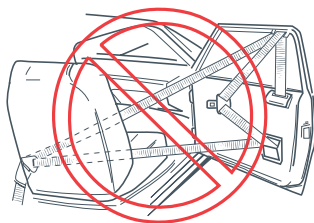

***Passive Restraints
Lap Or Shoulder Belt
Mounted On Front Door***

Section 7 - High Back Booster Car Seat Use

For use with children who are at least 3 years old, weigh between 33 and 100 lbs (15 and 45 kg) and whose height is between 33 and 57 inches (84 and 145 cm).

Securing Child With Lap And Shoulder Belt:

- 1** Select a vehicle seat position which has a lap and shoulder belt.
- 2** After selecting a seating location, if vehicle seat back is adjustable, adjust seat back into upright position.
- 3** Assemble seat back, see "Seat Back Assembly" section.
- 4** Place Booster Car Seat **forward-facing** on vehicle seat making sure both top and bottom of seat back are contacting vehicle seat back (**fig. a**).

DO NOT place the Booster Car Seat in a seating position that has only a vehicle lap belt (**fig. b**).

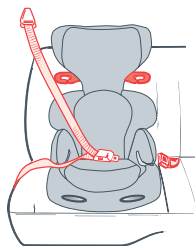

(fig. a)

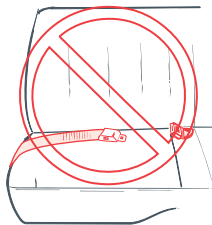

(fig. b)

Section 7 - High Back Booster Car Seat Use - continued

- 5** Position child in Booster Car Seat with child's back flat against back of Booster Car Seat.

- 6** Adjust headrest so that vehicle shoulder belt guide is at or above child's shoulder (*fig. c*).

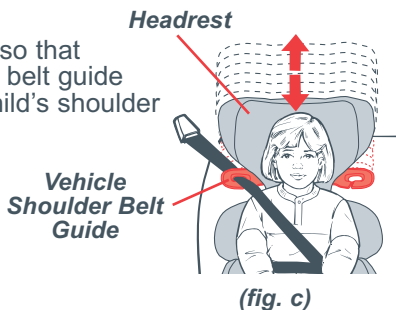

To raise or lower headrest:

- Lift gray headrest adjustment handle on rear of headrest ① and raise or lower headrest ② into one of the 7 positions (*fig. d*).

NOTE: Make sure headrest is locked into position.

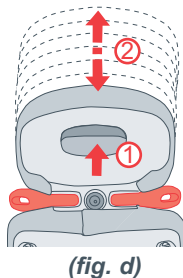

Section 7 - High Back Booster Car Seat Use - continued

- 7** Pull the vehicle lap and shoulder belt across front of child and buckle seat belt (*fig. e*).

- Position vehicle lap belt under both armrests ① and snugly adjust lap belt.
- Place the vehicle shoulder belt over child's chest and into the vehicle shoulder belt guide ②.

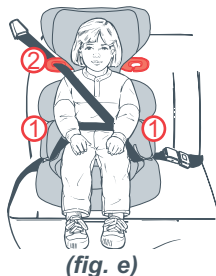

NOTE: Refer to vehicle owner's manual for instructions on proper use, placement and adjustment of the vehicle lap and shoulder belt.

- 8** Adjust vehicle shoulder belt guide so that shoulder belt is centered on the child's shoulder (*fig. f*).

To adjust vehicle shoulder belt guide:

- Pull out gray knob on back of headrest ① and slide vehicle shoulder belt guide left or right ② centering shoulder belt over child's shoulder (*fig. g*).

NOTE: Check that vehicle shoulder belt guide is locked into position.

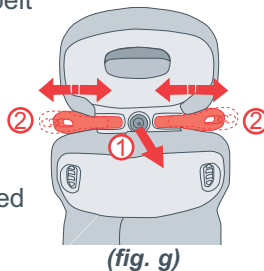

Section 7 - High Back Booster Car Seat Use - continued

9 Check fit of vehicle belts:

- The lap belt **MUST** be low on the hips contacting the thighs and under both armrests.
- The shoulder belt **MUST** contact the chest and be centered on the shoulder (**fig. h**).

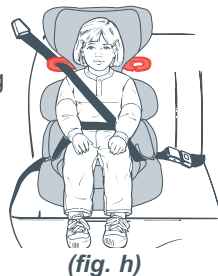

NOTE: Some active children may pull belt out or change position of belts.

- * Do not allow child to slide down under lap belt moving lap belt onto stomach or abdomen.
- * Do not allow child to place shoulder belt under arm or behind back (**fig. j**).

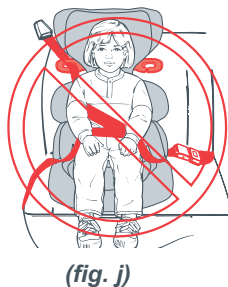

Section 8 - Booster Car Seat Use (Without Seat Back)

For use with children who are at least 3 years old, weigh between 33 and 100 lbs (15 and 45 kg) and whose height is between 33 and 57 inches (84 and 145 cm).

Discontinue use of the Booster Car Seat when the top of the child's ears are above top of the vehicle seat back or headrest.

Securing Child With Lap And Shoulder Belt:

- 1** Remove seat back from High Back Booster Car Seat, see "Seat Back Assembly" section.
- 2** Select a vehicle seat position which has a lap and shoulder belt.
- 3** After selecting a seating location, if vehicle seat back is adjustable, adjust seat back into upright position.

- 4** Place Booster Car Seat **forward-facing** on vehicle seat and contacting vehicle seat back (**fig. a**).

DO NOT place the Booster Car Seat in a seating position that has only a vehicle lap belt (**fig. b**).

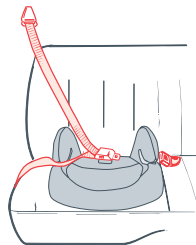

(fig. a)

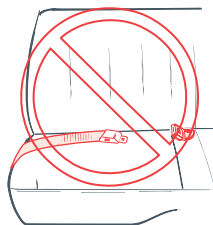

(fig. b)

Section 8 - Booster Car Seat Use (Without Seat Back) - continued

- 5** Position child in Booster Car Seat with child's back flat against vehicle seat back.
- 6** Pull the vehicle lap and shoulder belt across front of child and buckle seat belt (*fig. c*).

- Position vehicle lap belt under both armrests ① and snugly adjust lap belt.
- Place the vehicle shoulder belt over child's chest onto shoulder ②.



(*fig. c*)

NOTE: Refer to vehicle owner's manual for instructions on proper use, placement and adjustment of the vehicle lap and shoulder belt.

Section 8 - Booster Car Seat Use (Without Seat Back) - continued

7 Check fit of vehicle belts:

- The lap belt **MUST** be low on the hips contacting the thighs and under both armrests.
- The shoulder belt **MUST** contact the chest and be centered on the shoulder (**fig. d**).

If the vehicle shoulder belt contacts the child's neck or face or is off child's shoulder:

- Use adjustable shoulder belt anchorage in your vehicle, if available, to reposition shoulder belt.
- If adjustable shoulder belt anchorage is not available or does not properly position shoulder belt, use shoulder belt positioner provided with the Booster Car Seat (**fig. e**).



Shoulder Belt Positioner

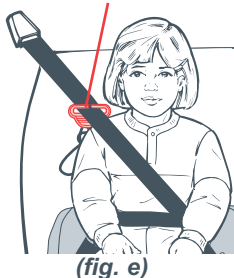

Section 8 - Booster Car Seat Use (Without Seat Back) - continued

8 Use and adjustment of shoulder belt positioner:

- Remove shoulder belt positioner from storage location under base (*fig. f*).

Shoulder Belt Positioner Storage

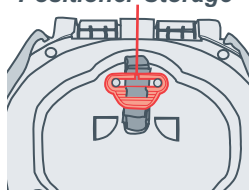

(*fig. f*)

- Place vehicle shoulder belt into shoulder belt positioner (*fig. g*).

Shoulder Belt Positioner



(*fig. g*)

- Adjust the height of the shoulder belt positioner to center the vehicle shoulder belt over the child's shoulder (*fig. h*).
To adjust the height, pull the webbing up or down through the web adjuster slot in the shoulder belt positioner.



(*fig. h*)

Section 8 - Booster Car Seat Use (Without Seat Back) - continued

NOTE: Some vehicle shoulder belts with emergency locking retractors allow child to pull belt out and change position of belt. Use of shoulder belt positioner helps maintain proper position of shoulder belt.

Some active children may pull belt out or change position of belts.

* Do not allow child to slide down under lap belt moving lap belt onto stomach or abdomen.

* Do not allow child to place shoulder belt under arm or behind back (*fig. j*).



(*fig. j*)

Section 9 - Seat Back Assembly

To assemble seat back:

- Place Booster Car Seat base on floor or firm surface.
- Holding seat back parallel to floor and with front surface facing up, place tabs at bottom of seat back into slots of seat base ① (*fig. a*).
- While pushing tabs at bottom of seat back down into slots of seat base, rotate seat back upright ②.

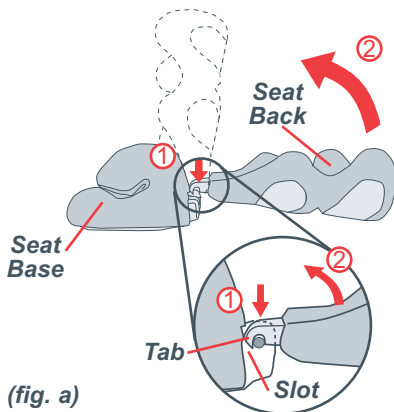

To remove seat back:

- Place High Back Booster Car Seat on the floor or other firm surface.
- While holding the base down, rotate seat back past plastic locking tabs so back is parallel to the floor.
- Pull tabs on lower seat back out of seat base.

Section 10 - Additional Information

Certification

This child restraint system conforms to all applicable Federal Motor Vehicle Safety Standards for use in motor vehicles.

Aircraft Use

This restraint is NOT certified for aircraft use.

An aircraft does not have lap and shoulder belt systems required to use Booster Car Seats.

Warm Weather

Car seat parts can get very hot in the sun or warm weather.

To avoid burns, always check before putting child in car seat.

Vehicle Seat Protection

Protect vehicle seat. Use a thin car seat mat, thin towel, or thin blanket under and behind car seat.

Instruction Manual Storage

Store under seat base.

Car Seat Useful Life

DO NOT use after 7 years from date of manufacture on label.

Section 11 - Care and Cleaning

Removing Seat Base Pad, Seat Back Pad and Headrest Pad:

- If the seat back is attached to the seat base, remove seat back, see "Seat Back Assembly" section.

To Remove Seat Base Pad:

- Unhook elastic from seat base.
- Gently slide and pull seat pad off of seat base armrests and air circulation vents.

To Remove Seat Back Pad:

- Unsnap snaps on pad from back of seat pad.
- Gently slide and pull pad off of seat back.

To Remove Headrest Pad:

- Unhook elastic from bottom of headrest.
- Unhook elastic tabs on pad from back of headrest.
- Gently slide and pull pad off of headrest.
- Remove egg shock from pocket inside headrest pad before washing pad.

Reverse above steps for replacing pads.

NOTE: Openings in front of seat base pad MUST be placed behind flange of air circulation vents.

Cleaning Seat Base Pad, Seat Back Pad and Headrest Pad:

- Hand wash in cool water and mild soap. Roll in towel to remove excess water and lay flat to dry.

Cleaning Shell:

- Wipe with mild solution of soap and water. Avoid wetting labels.
- Rinse with clean water.
- Never use "household" detergents or solvents.

Section 12 - Re-use After A Crash

WARNING **DEATH or SERIOUS INJURY can occur**

- **DO NOT** allow any re-use of this car seat after a crash unless crash and car seat meet **ALL** conditions in “Re-use After A Crash” section of this manual. Do not sell or allow others to use a car seat that has been in a crash and it does not comply with **ALL** of these conditions.

Car seats are damaged in vehicle crashes and in many cases, the car seat must be destroyed and replaced. However, the National Highway Traffic Safety Administration (NHTSA) advises that if a child restraint (car seat) has been used in a minor crash that the child restraint can continue to be used with your child.

For information on car seat re-use after a crash, check the NHTSA website at:

www.nhtsa.dot.gov/people/injury/childps,
select “Child Restraint Re-use After Minor Crashes” and then “NHTSA Position”.

Damage to car seats may be difficult to see or it may be difficult to verify the damage to the car seat. For those situations where any of the NHTSA Child Restraint Re-use criteria has not been met, or if there is uncertainty whether damage to the seat has occurred, NHTSA and Combi USA advise parents or caregivers to contact their automobile insurance company regarding its policy on replacement of seats.

DO NOT risk your child’s safety.

Section 13 - Registration Information

Child restraints (car seats) could be recalled for safety reasons. You must register this restraint to be reached in a recall. Fill out the registration card attached to car seat and mail today or send your name, address, and the restraint's model number and manufacturing date to:

Combi USA
1962 Hwy 160 West, Suite #100
Fort Mill, SC 29708
or call 1-800-992-6624
or fax 1-803-548-3663
or log onto www.combi-intl.com

For recall information:

- Call the U.S Government's Auto Safety Hotline at 1-800-424-9393 (202-366-0123 in D.C. area)
- Log onto the National Highway Traffic Safety Administration recall website at:
www-odi.nhtsa.dot.gov/cars/problems/recalls/childseat.cfm
- Contact Combi USA (see contact information above)

Section 14 - Limited Warranty

1. Combi USA products, when purchased from an authorized retailer; are warranted to the original purchaser to be free of defect in materials and workmanship for a period of one (1) year from date of purchase. Warranty is valid for products purchased and used in the U.S. only, and used in compliance with the warrantor's use and maintenance instructions. Save your carton and receipt in case of return for warranty service is necessary.
2. During the warranty period your Combi product will either be repaired or replaced, at the warrantor's discretion, without charge if it is purchased from an authorized Combi dealer and is found to be defective in workmanship or materials. For service call 1-800-99-COMBI. The warrantor shall not be responsible for any costs incurred by the consumer in returning a defective product for repair.

This limited warranty shall not apply to normal wear to the product, or if the product has been:

- a. Damaged due to accidents, misuse, abuse or neglect as determined by Combi.
- b. Tampered with or repaired by other than an authorized Combi repair center or with parts other than Combi approved parts.
- c. Leased or rented for commercial use.

Section 14 - Limited Warranty - continued

THE WARRANTY PROVIDED HEREIN IS EXCLUSIVE AND IS IN LIEU OF ALL OTHER EXPRESS WARRANTIES. ANY IMPLIED WARRANTIES, INCLUDING ANY IMPLIED WARRANTY OF MERCHANTABILITY OR FITNESS FOR A PARTICULAR PURPOSE ARE EXPRESSLY EXCLUDED. WARRANTOR'S OBLIGATIONS AND THE CONSUMER'S OR OTHER BUYERS REMEDIES UNDER THE LIMITED WARRANTY ABOVE ARE EXCLUSIVE AND ARE STRICTLY LIMITED TO REPAIR OR REPLACEMENT AS STATED. ANY INCIDENTAL OR CONSEQUENTIAL DAMAGES ON THE PART OF THE WARRANTOR AND ANY SUPPLIER OR DEALER ARE HERBY ALSO EXPRESSLY EXCLUDED.

Some states limit or do not allow exclusions or limitations on how long an implied warranty lasts so the above limitations may not apply to you. Some states do not allow the exclusion or limitations of incidental or consequential damages, so the above limitations or exclusion may not apply to you. This warranty give you specific legal rights, and you may also have other rights which vary from state to state.

Combi®

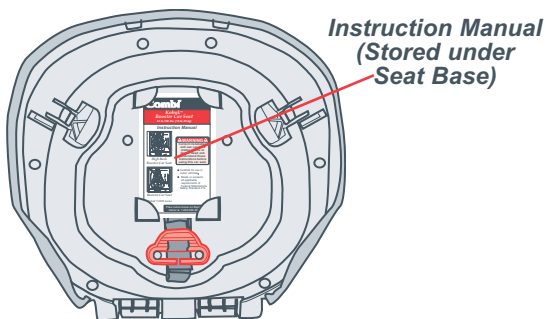

Keep this instruction manual for future use.
Store under seat base.

© 2005 Combi USA

8970 - 03/05

Combi USA • 1962 Hwy 160 West,
Suite #100 • Fort Mill, SC 29708
• For Technical Questions,
please call 1-800-992-6624
• Se Habla Español 1-803-548-6633
• Fax 1-803-548-3663 • www.combi-intl.com