

Bahama

"...finding solutions for families,
especially busy moms."™

www.omnialeather.com www.kathyireland.com



by
OMNIA
FURNITURE

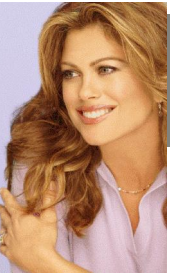

6.20.07

STANDARD

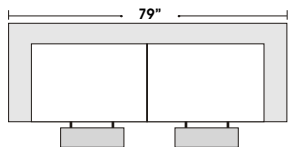

Reclining 2 Seat Sofa (Motors Not Available on Sofa)

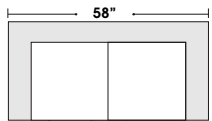

Reclining Loveseat

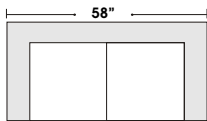

Stationary Loveseat

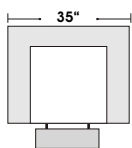

Recliner

1/2 CURVE

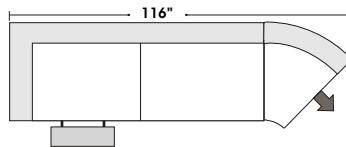

Left Arm 2 Seat Sofa w 1/2 Curve

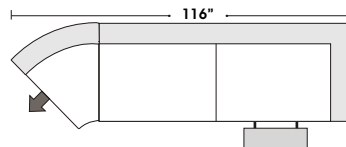

Right Arm 2 Seat Sofa w 1/2 Curve

SLEEPERS

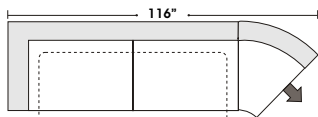

Left Arm Queen Sleeper
w 1/2 Curve

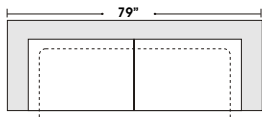

Full Sleeper

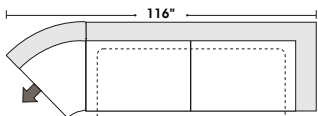

Right Arm Queen Sleeper
w 1/2 Curve

Features

Standard:

- All Full or Top-Grain Leather
- All hardwood frames
- Recliner

Options:

- Motorized Recliner Unit (Additional Charges Apply)

Sleeper Options:

- Full Sleeper Option Available w/ Standard Mattress (Additional Charges Apply)
- Deluxe Innerspring Mattress: Queen / Full / Twin (Additional Charges Apply)
- Air Dream Coil Mattress: Queen or Full Size Only (Additional Charges Apply)

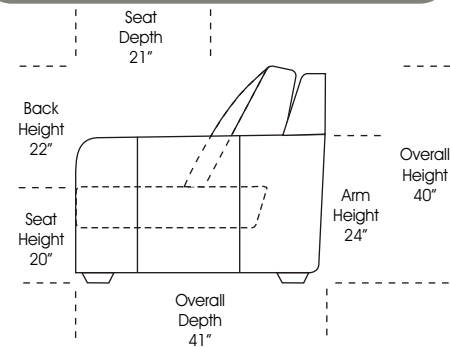

Actual Hard Frame Height 33"



Note: All sizes are approximate.

Suggested Configurations

