



induo+

IN+OUTDOOR COOKING

PRODUCT CATALOGUE 2010



COOKING

indu+

indu+ introduces a completely new cooking experience. With its modular induction hobs and rolling trolleys, you can easily move the kitchen outdoors in no time. The induction hobs in the trolleys are modular and can therefore be easily changed and adapted to the menu requirements: cooking, wokking, grilling or preparing teppanyaki, indoors or outdoors, the trolleys provide unprecedented flexibility. Besides, induction cooking itself is advancing rapidly because it is a fast way of cooking, saves energy and perfectly matches a healthy diet. Explore!

www.induplus.eu

WITHOUT LIMITS



indu+
TROLLEY BEECHBOY









indu+ BEECHBOY

- beech: oiled (untreated on demand)
- brushed stainless steel 316
- waterproof cover included



indu+ BEECHBOY SOLO

- measurements
600mm x 600mm x 900mm
- weight
46 kg

ref. 130.010.302



indu+ BEECHBOY DUO

- measurements
1000mm x 600mm x 900mm
- weight
63 kg

ref. 130.010.332



indu+ BEECHBOY ULTIMO

- measurements
1400mm x 600mm x 900mm
- weight
78 kg

ref. 130.010.352

Note: cooking plates are not included but optional



CUSTOMIZE YOUR indu+ BEECHBOY

Your BeechBoy can easily be customized with these cooking plates and accessories. The modular cooking plates in the trolley allow you to cook, wok, grill, make teppanyaki, ... indoors or outdoors to your heart's content. They provide unknown flexibility because the hobs can easily be exchanged. The extra accessories make your trolley the perfect organized outdoor kitchen.

COOKING PLATES



indu+ 400 domino
ref. 132.040.010



indu+ 400 wok
ref. 132.040.000



indu+ 400 combi
ref. 132.040.001



indu+ 400 grill
ref. 132.040.020



indu+ 400 teppanyaki
ref.132.040.030

ACCESSORIES



indu+ cutting board beech
ref. 130.041.013

Used as an extension for the trolley
or to replace a cooking plate



indu+ knife holder beech
ref. 130.041.016

Your knives kept closeby
and safe



indu+ wok insert
250 mm: ref. 132.050.001
314 mm: ref. 132.050.000

SOME EXAMPLES





indu+
TROLLEY SERVEBOY









indu+ SERVEBOY

- walnut
- brushed stainless steel 316
- Kerrock® finishing
- waterproof cover included
- cutting board included
- knife holder included
- bottle holder included



indu+ SERVEBOY SOLO

- measurements
600mm x 600mm x 900mm
- weight
43 kg

ref. 130.020.000



indu+ SERVEBOY DUO

- measurements
1000mm x 600mm x 900mm
- weight
62 kg

ref. 130.020.001



indu+ SERVEBOY ULTIMO

- measurements
1400mm x 600mm x 900mm
- weight
77 kg

ref. 130.020.004

Note: cooking plates are not included but optional



CUSTOMIZE YOUR indu+ SERVEBOY

Your ServeBoy can easily be customized with these cooking plates and accessories. The modular cooking plates in the trolley allow you to cook, wok, grill, make teppanyaki, ... indoors or outdoors to your heart's content. They provide unknown flexibility because the hobs can easily be exchanged. The extra accessories make your trolley the perfect organized outdoor kitchen.

COOKING PLATES



indu+ 400 domino
ref. 132.040.010



indu+ 400 wok
ref. 132.040.000



indu+ 400 combi
ref. 132.040.001



indu+ 400 grill
ref. 132.040.020



indu+ 400 teppanyaki
ref.132.040.030

ACCESSORIES



indu+ cutting board walnut
ref. 130.041.013

Used as an extension for the trolley
or to replace a cooking plate



indu+ knife holder walnut
ref. 130.041.016

Your knives kept closeby
and safe



indu+ wok insert
250 mm: ref. 132.050.001
314 mm: ref. 132.050.000

SOME EXAMPLES





indu+
TROLLEY SERVEBOY
SUPERBIANCO





indu+





indu+ SERVEBOY SUPERBIANCO

- walnut
- brushed stainless steel 316
- Kerrock® finishing
- waterproof cover included
- cutting board included
- knife holder included
- bottle holder included



indu+ SERVEBOY DUO SUPERBIANCO

- measurements
1000mm x 600mm x 900mm
- weight
72 kg

ref. 130.020.002



indu+ SERVEBOY ULTIMO SUPERBIANCO

- measurements
1400mm x 600mm x 900mm
- weight
85 kg

ref. 130.020.003

Note: cooking plates are not included but optional



CUSTOMIZE YOUR indu+ SERVEBOY SUPERBIANCO

Your ServeBoy superbianco can easily be customized with these cooking plates and accessories. The modular cooking plates in the trolley allow you to cook, wok, grill, make teppanyaki, ... indoors or outdoors to your heart's content. They provide unknown flexibility because the hobs can easily be exchanged. The extra accessories make your trolley the perfect organized outdoor kitchen.

COOKING PLATES



indu+ 400 domino
ref. 132.040.010



indu+ 400 wok
ref. 132.040.000



indu+ 400 combi
ref. 132.040.001



indu+ 400 grill
ref. 132.040.020



indu+ 400 teppanyaki
ref.132.040.030

ACCESSORIES



indu+ cutting board walnut
ref. 130.041.013

Used as an extension for the trolley
or to replace a cooking plate



indu+ knife holder walnut
ref. 130.041.016

Your knives kept closeby
and safe



indu+ wok insert
250 mm: ref. 132.050.001
314 mm: ref. 132.050.000

SOME EXAMPLES





indut+
TROLLEY TOMBOY









indu+ TOMBOY

- walnut
- brushed stainless steel 316
- waterproof cover included
- cutting board included
- knife holder included
- bottle holder included



indu+ TOMBOY DUO

- measurements
1000mm x 600mm x 900mm
- weight
67 kg

ref. 130.030.001



indu+ TOMBOY ULTIMO

- measurements
1400mm x 600mm x 900mm
- weight
82 kg

ref. 130.030.002

Note: cooking plates are not included but optional



CUSTOMIZE YOUR indu+ TOMBOY

Your TomBoy can easily be customized with these cooking plates and accessories. The modular cooking plates in the trolley allow you to cook, wok, grill, make teppanyaki, ... indoors or outdoors to your heart's content. They provide unknown flexibility because the hobs can easily be exchanged. The extra accessories make your trolley the perfect organized outdoor kitchen.

COOKING PLATES



indu+ 400 domino
ref. 132.040.010



indu+ 400 wok
ref. 132.040.000



indu+ 400 combi
ref. 132.040.001



indu+ 400 grill
ref. 132.040.020



indu+ 400 teppanyaki
ref.132.040.030

ACCESSORIES



indu+ cutting board beech
ref. 130.041.013

Used as an extension for the trolley
or to replace a cooking plate



indu+ knife holder beech
ref. 130.041.016

Your knives kept closeby
and safe



indu+ wok insert
250 mm: ref. 132.050.001
314 mm: ref. 132.050.000

SOME EXAMPLES



indu+
400 DOMINO

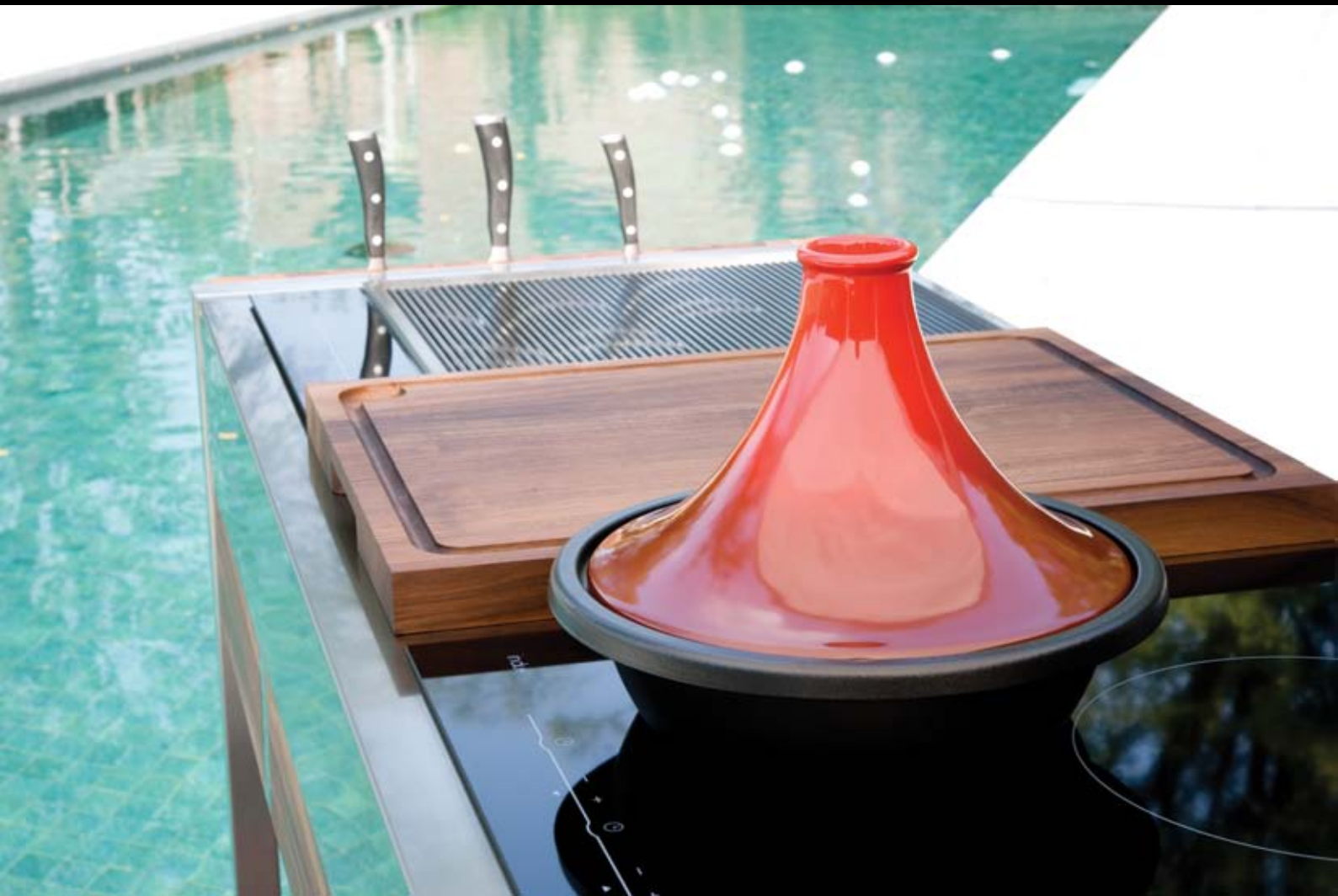



induct+ 400 DOMINO

DESIGN

- 2 cooking zones
- latest generation induction
- independent inductors
- high efficiency
- 2 timers, simultaneously usable
- 2 independent boosters
- egg-timer
- pan detection
- flat built-in possibility
(intervention from beneath)

EASE OF USE

- central intuitive command via touch control
- digital display of power
(steps 1 - 12 / booster)
- easy to clean vitroceramic glass

SECURITY

- boil over protection
- safety against overheating of the cooking plate
- child lock
- residual heat indication
- automatic stop



indu+ 400 DOMINO

TECHNICAL INFORMATION

- total power consumption 3700W
- cooking zone left 1400W, 1800W booster, 155 mm diameter
- cooking zone right 1800W, 2800W booster, 220 mm diameter
- power 230V / 16A
- outside measurements 400 mm x 520 mm
- built-in measurements 370 mm x 475 mm
- thickness glass 4 mm
- total height 48 mm

ref. 132.040.010

5 years warranty

COOKING PLATE



BUILT-ON

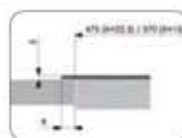
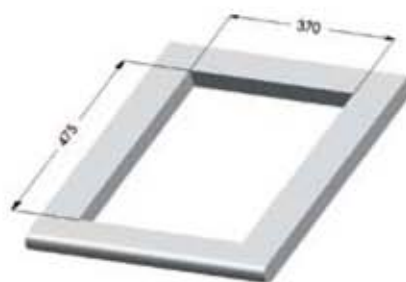

BUILT-IN

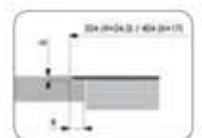
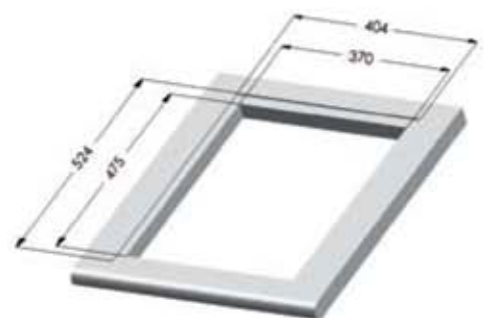

indu+
400 WOK





indu+ 400 WOK

DESIGN

- latest generation induction
- spherical inductor
- high efficiency
- timer
- booster
- egg-timer
- pan detection
- flat built-in possibility
(intervention from beneath)

EASE OF USE

- central intuitive command via touch control
- digital display of power
(steps 1 - 9 / booster)
- easy to clean vitroceramic glass

INCLUDED ACCESSORIES

- wok pan and wok frame

SECURITY

- boil over protection
- safety against overheating of the cooking plate
- child lock
- residual heat indication
- automatic stop



indu+ 400 WOK

TECHNICAL INFORMATION

- total power consumption 3200W
- power 230V / 16A
- wok 2500W power, 3200W booster, 314 mm diameter
- outside measurements 400 mm x 520 mm
- built-in measurements 370 mm x 475 mm
- glass thickness 6 mm
- total height 130 mm

ref. 132.040.000

5 years warranty

COOKING PLATE

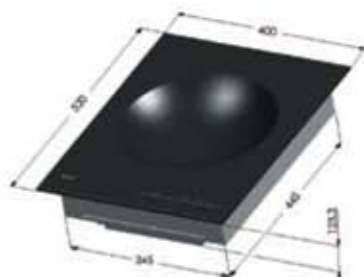

BUILT-ON

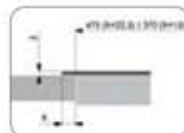

BUILT-IN

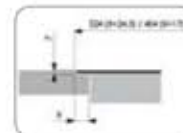
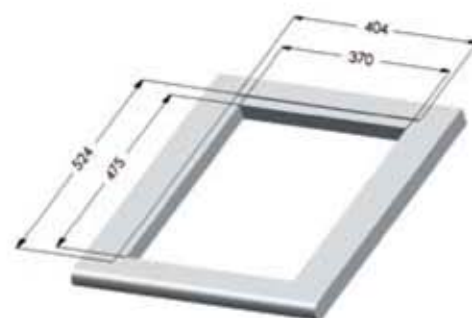

AVAILABLE ACCESSORY

indu+ wok insert 314 mm

Two in one thanks to the wok insert:
the "normal" flat induction hob is restored by
means of the wok insert.
Hence, this hob gives you double pleasure.

ref. 132.050.000



indu+
400 COMBI



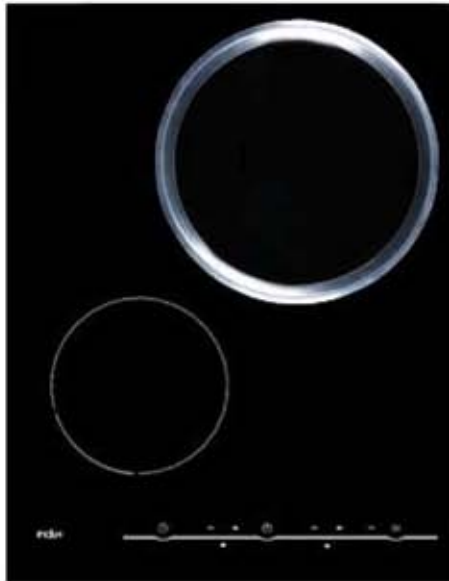

induplus 400 COMBI

DESIGN

- 2 cooking zones: 1 flat and 1 wok
- latest generation induction
- independent inductors
- high efficiency
- 2 timers, simultaneously usable
- 2 independent boosters
- egg-timer
- pan detection
- flat built-in possibility
(intervention from beneath)

EASE OF USE

- central intuitive command via touch control
- digital display of power
(steps 1 - 12 / booster)
- easy to clean vitroceramic glass

INCLUDED ACCESSORIES

- wok pan and wok frame

SECURITY

- boil over protection
- safety against overheating of the cooking plate
- child lock
- residual heat indication
- automatic stop



indu+ 400 COMBI

TECHNICAL INFORMATION

- total power consumption 3600W
- cooking zone front 1400W, 1800w booster, 155 mm diameter
- cooking zone back 1800W, 2800w booster, 250 mm diameter
- power 230V / 16A
- outside measurements 400 mm x 520 mm
- built-in measurements 370 mm x 475 mm
- thickness glass 4 mm
- total height 99 mm

ref. 132.040.001

5 years warranty

COOKING PLATE



BUILT-ON

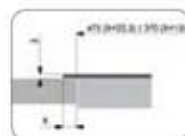
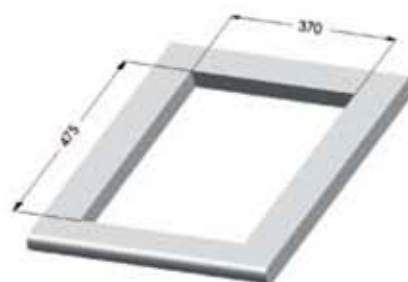

BUILT-IN

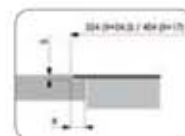
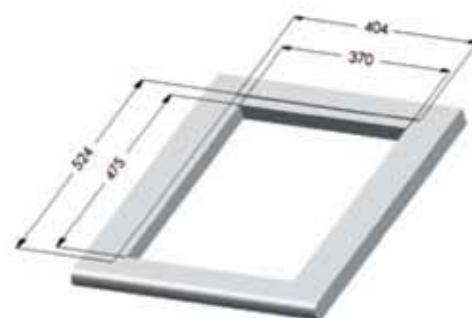

AVAILABLE ACCESSORY

indu+ wok insert 250 mm

Two in one thanks to the wok insert:
the "normal" flat induction hob is restored by
means of the wok insert.
Hence, this hob gives you double pleasure.

ref. 132.050.001



indu+
400 GRILL





induct+ 400 GRILL

DESIGN

- 2 cooking zones
- powerful infrared technology
- high efficiency
- 2 timers, simultaneously usable
- egg-timer

EASE OF USE

- central intuitive command via touch control
- digital display of power (steps 1 - 9)
- easy to clean vitroceramic glass

SECURITY

- safety against overheating of the cooking plate
- child lock
- residual heat indication
- automatic stop



indu+ 400 GRILL

TECHNICAL INFORMATION

- total power consumption 2500W
- power zone 1 1300W
- power zone 2 1200W
- power 230V / 16A
- outside measurements 400 mm x 520 mm
- built-in measurements 370 mm x 475 mm
- thickness glass 4 mm
- total height 65 mm
- temperatures 50°C - 380°C

ref. 132.040.020

5 years warranty

COOKING PLATE

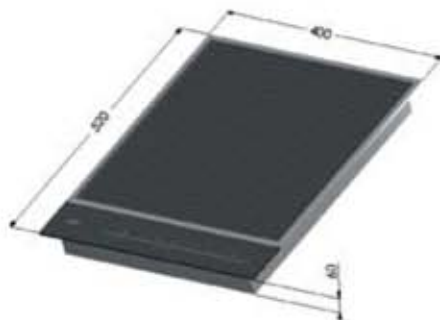

BUILT-ON



indu+

400 TEPPANYAKI





induct+ 400 TEPPANYAKI

DESIGN

- 2 cooking zones
- powerful infrared technology
- high efficiency
- 2 timers, simultaneously usable
- egg-timer

EASE OF USE

- central intuitive command via touch control
- digital display of power (steps 1 - 9)
- easy to clean

INCLUDED ACCESSORIES

- 2 spatulas

SECURITY

- safety against overheating of the cooking plate
- child lock
- residual heat indication
- automatic stop



indu+ 400 TEPPANYAKI

TECHNICAL INFORMATION

- total power consumption 2500W
- power zone 1 1600W
- power zone 2 900W
- power 230V / 16A
- outside measurements 400 mm x 520 mm
- built-in measurements 370 mm x 475 mm
- thickness inox 4 mm
- total height 65 mm
- temperature 50°C - 260°C

ref. 132.040.030

5 years warranty

COOKING PLATE



BUILT-ON

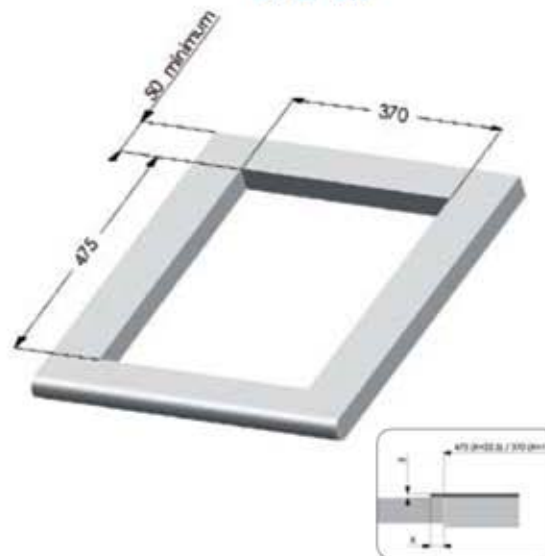

indu+

INDOOR COOKING PLATES



induct

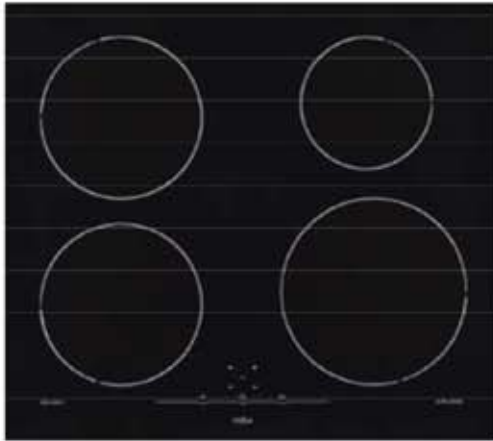

induct+ 600

DESIGN

- 4 cooking zones
- latest generation induction
- independent inductors
- high efficiency
- 4 timers, simultaneously usable
- 4 independent boosters
- egg-timer
- pan detection
- facet finishing

EASE OF USE

- central intuitive command via touch control
- digital display of power (1 - 9 / booster)
- easy to clean vitroceramic glass

SECURITY

- boil over protection
- safety against overheating of the cooking plate
- child lock
- residual heat indication
- automatic stop



indu+ 600

TECHNICAL INFORMATION

• total power consumption	7400W
• cooking zone left front	1850W, 2500W booster, 190 mm diameter
• cooking zone left back	1850W, 2500W booster, 190 mm diameter
• cooking zone right front	1400W, 1800W booster, 155 mm diameter
• cooking zone right back	2300W, 3300W booster, 220 mm diameter
• outside measurements	590 mm x 520 mm
• built-in measurements	560 mm x 490 mm
• thickness glass	4 mm
• total height	48 mm

ref. 132.600.000

5 years guarantee

COOKING PLATE



BUILT-ON

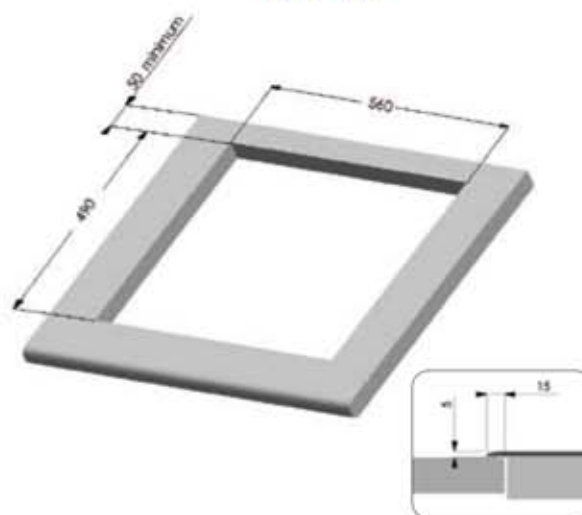

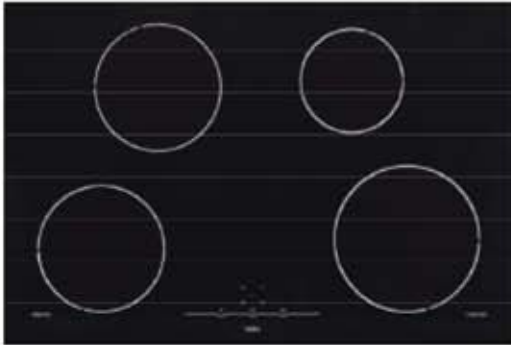

induct+ 750

DESIGN

- 4 cooking zones
- latest generation induction
- independent inductors
- high efficiency
- 4 timers, simultaneously usable
- 4 independent boosters
- egg-timer
- pan detection
- facet finishing

EASE OF USE

- central intuitive command via touch control
- digital display of power (1 - 9 / booster)
- easy to clean vitroceramic glass

SECURITY

- boil over protection
- safety against overheating of the cooking plate
- child lock
- residual heat indication
- automatic stop



indu+ 750

TECHNICAL INFORMATION

• total power consumption	7400W
• cooking zone left front	1850W, 2500W booster, 190 mm diameter
• cooking zone left back	1850W, 2500W booster, 190 mm diameter
• cooking zone right front	1400W, 1800W booster, 155 mm diameter
• cooking zone right back	2300W, 3300W booster, 220 mm diameter
• outside measurements	780 mm x 520 mm
• built-in measurements	750 mm x 490 mm
• thickness glass	4 mm
• total height	48 mm

ref. 132.750.000

5 years guarantee

COOKING PLATE



BUILT-ON

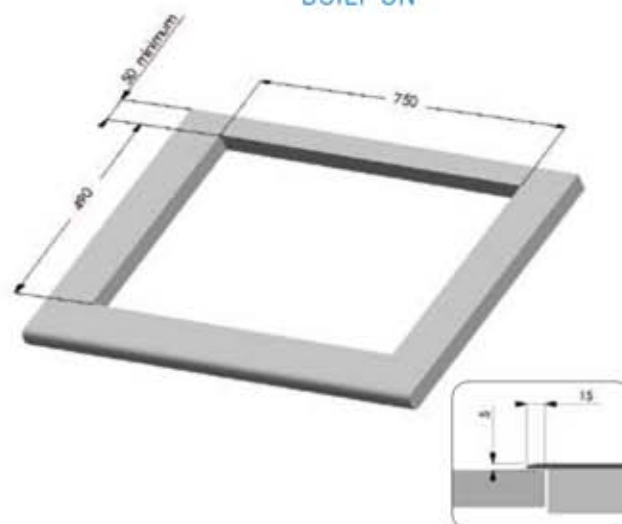

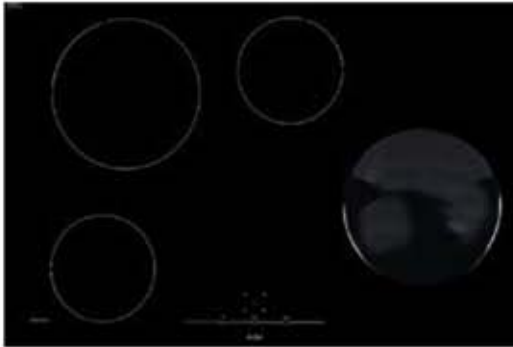

induct+ 750 WOK

DESIGN

- 4 cooking zones: 3 flat and 1 wok
- latest generation induction
- independent inductors
- high efficiency
- 2 timers, simultaneously usable
- 2 independent boosters
- egg-timer
- pan detection
- flat built-in possibility
(intervention from beneath)

EASE OF USE

- central intuitive command via touch control
- digital display of power
(1 - 9 / booster)
- easy to clean vitroceramic glass

INCLUDED ACCESSORIES

- wok pan and wok frame

SECURITY

- boil over protection
- safety against overheating of the cooking plate
- child lock
- residual heat indication
- automatic stop



indu+ 750 WOK

TECHNICAL INFORMATION

• total power consumption	7400W
• cooking zone left	1400W, 1800W booster, 155 mm diameter
• cooking zone right	2300W, 3200W booster, 220 mm diameter
• wok zone	2300W, 3200W booster, 250 mm diameter
• cooking zone back right	1400W, 1800W booster, 155 mm diameter
• outside measurements	780 mm x 520 mm
• built-in measurements	750 mm x 490 mm
• thickness glass	6 mm
• total height	72 mm

ref. 132.750.040

5 years guarantee

COOKING PLATE

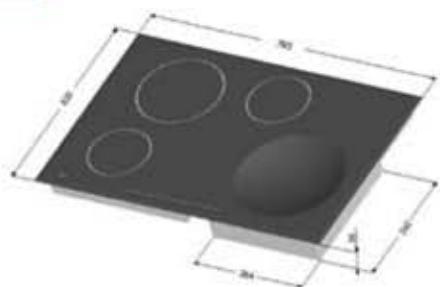

BUILT-ON

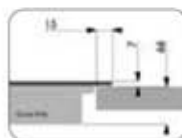
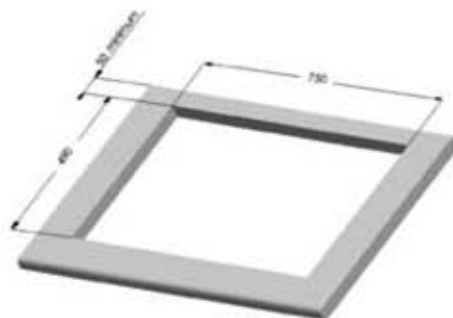

BUILT-IN

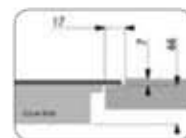
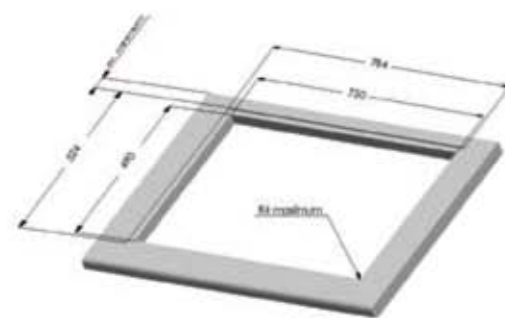

AVAILABLE ACCESSORY

indu+ wok insert 250 mm

Two in one thanks to the wok insert:
the "normal" flat induction hob is restored by
means of the wok insert.
Hence, this hob gives you double pleasure.

ref. 132.050.001



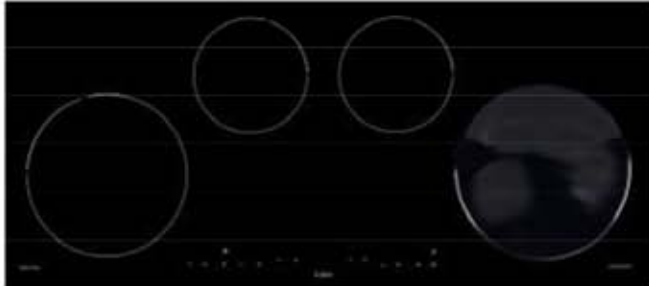

indu+ 900 WOK

DESIGN

- 4 cooking zones: 3 flat and 1 wok
- latest generation induction
- independent inductors
- high efficiency
- 2 timers, simultaneously usable
- 2 independent boosters
- egg-timer
- pan detection
- keeping warm function
- flat built-in possibility
(intervention from beneath)

EASE OF USE

- central intuitive command via touch control
- digital display of power
(1 - 9 / booster)
- easy to clean vitroceramic glass

INCLUDED ACCESSORIES

- wok pan and wok frame

SECURITY

- boil over protection
- safety against overheating of the cooking plate
- child lock
- residual heat indication
- automatic stop
- pause function



indu+ 900 WOK

TECHNICAL INFORMATION

• total power consumption	7400W
• cooking zone left front	2300W, 3200W booster, 220 mm diameter
• cooking zone left back	1400W, 1800W booster, 155 mm diameter
• wok zone	2300W, 3200W booster, 250 mm diameter
• cooking zone right back	1400W, 1800W booster, 155 mm diameter
• outside measurements	900 mm x 400 mm
• built-in measurements	875 mm x 375 mm
• thickness glass	6 mm
• total height	101 mm

ref. 132.900.040

5 years guarantee

COOKING PLATE



BUILT-ON

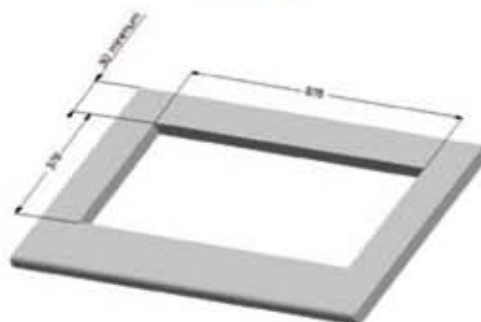

BUILT-IN

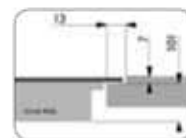
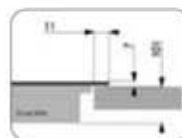
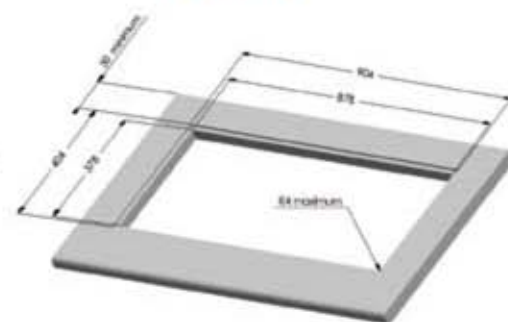

AVAILABLE ACCESSORY

indu+ wok insert 250 mm

Two in one thanks to the wok insert:
the "normal" flat induction hob is restored by
means of the wok insert.
Hence, this hob gives you double pleasure.

ref. 132.050.001



indu+

PRODUCT OVERVIEW



1. COOKING PLATES
2. TROLLEYS
3. ACCESSORIES

	O. Ref.	ARTICLE		
	132.040.010	indu+ 400 Domino		
	132.040.001	indu+ 400 Combi		
	132.040.000	indu+ 400 Wok		
	132.040.020	indu+ 400 Grill		
	132.040.030	indu+ 400 Teppanyaki		
	132.600.000	indu+ 600		
	132.750.000	indu+ 750		
	132.750.040	indu+ 750 Wok		
	132.900.040	indu+ 900 Wok		

	O. Ref.	ARTICLE		
	130.010.302	BeechBoy Solo		
	130.010.332	BeechBoy Duo		
	130.010.352	BeechBoy Ultimo		
	130.020.000	ServeBoy Solo		
	130.020.001	ServeBoy Duo		
	130.020.004	ServeBoy Ultimo		
	130.020.002	ServeBoy Duo Superbianco		
	130.020.003	ServeBoy Ultimo Superbianco		
	130.030.001	TomBoy Duo		
	130.030.002	TomBoy Ultimo		
	400.827.026	indu+ Flightcase Duo		
	400.824.027	indu+ Flightcase Ultimo		

	O. Ref.	ARTICLE		
	132.050.001	indu+ Wok Insert 250 mm		
	132.050.000	indu+ Wok Insert 314 mm		
	130.041.014	Cutting Board Walnut		
	130.041.015	Knife holder Walnut		
	130.041.013	Cutting Board Beech		
	130.041.016	Knife Holder Beech		

IN+OUTDOOR COOKING



indu+

indu+ nv/sa
Zultseweg 10
8790 Waregem
BELGIUM

info@induplus.eu
www.induplus.eu
T +32 (0)56 72 36 87
F +32 (0)56 72 36 88

© All rights reserved.