



INSTALLATION, OPERATION AND MAINTENANCE MANUAL

Warning

Please read carefully before proceeding with installation. Your failure to follow any attached instructions or operating parameters may lead to the product's failure.

Save manual for future reference

MODELS

PREMIER 25

RO-TFM-4SV

RO-TFM-5SV



System Tested and certified by WQA against NSF/ANSI Standard 58 for the reduction of the claims specified on the performance data sheet.



EPA / ETV Test verified performance.
Physical removal of microbial
contamination agents in drinking water.

Refer to enclosed warranty for operating parameters to ensure proper use with your water supply.

Thank you for your purchase of a state of the art Premier Reverse Osmosis (RO) water treatment system. Water quality concerns are becoming more of a focus for the public. You may have heard about contaminants in the drinking water, such as Arsenic, Chromium, Cryptosporidium or Giardia. There may also be some local water issues such as high levels of Lead and Copper. This Premier water treatment system has been designed and tested to provide you with high quality drinking water for years to come. The following is a brief overview of the system.

Your Reverse Osmosis System:

Osmosis is the process of water passing through a semi permeable membrane in order to balance the concentration of contaminants on each side of the membrane. A semi permeable membrane is a barrier that will pass some particles like clean drinking water, but not other particles like arsenic and lead.

Reverse osmosis uses a semi permeable membrane; however, by applying pressure across the membrane, it concentrates contaminants (like a strainer) on one side of the membrane, producing crystal clear water on the other. This is why RO systems produce both clean drinking water and waste water that is flushed from the system. This reverse osmosis system also utilizes carbon block filtration technology, and can therefore provide a higher quality drinking water than carbon filtration systems alone.

Your system is a four or five stage RO which is based upon separate treatment segments within the one complete water filtration system. These stages are as follows:

Stage 1 – Sediment filter, recommended change 6 months.

The first stage of your RO system is a five micron sediment filter that traps sediment and other particulate matter like dirt, silt and rust which affect the taste and appearance of your water.

Stage 2 and 3 – Carbon filters, recommended change 6 months.

The second and third stages each contain a 5 micron carbon block filter. This helps ensure that chlorine, chloramines and other materials that cause bad taste and odor are greatly reduced.

Stage 4- Membrane, recommended change 2-5 years.

Stage four is the heart of the reverse osmosis system, the RO membrane. This semi permeable membrane will effectively take out TDS & Sodium and a wide range of contaminants such as Perchlorate, Chromium, Arsenic, Copper, Lead as well as Cysts, such as Giardia and Cryptosporidium. Because the process of extracting this high quality drinking water takes time, your RO water treatment system is equipped with a storage tank.

Stage 5- Carbon in-line filter, recommended change 6 - 12 months.

The final stage is an in-line granular activated carbon (GAC) filter. This filter is used after the water storage tank, and is used as a final polishing filter.

Note: Filter & Membrane life may vary based upon local water conditions and/or use patterns.

System Maintenance

Just because you can not taste it, does not mean that it is not there. Contaminants such as Lead, Chromium and Arsenic are undetectable to the taste. Additionally, over time if you do not replace the filter elements, other bad tastes and odors will be apparent in your drinking water.

It is important to change out your filters at the recommended intervals as indicated in this system manual. When replacing the filter elements, pay special attention to any cleaning instructions. Should you have any further questions please refer to our web site at www.premierh2o.com or call our customer service department at **1-800-752-5582**.

With proper installation and maintenance, this system will provide you with high quality water for years to come. All of Premier's water enhancement products are rigorously tested by independent laboratories for safety and reliability. If you have any questions or concerns, please contact our customer service department at 1-800-752-5582 (outside USA 480-675-7995) or refer to our on-line troubleshooting guide at www.premierh2o.com.

Before installation, please take a moment to fill out the warranty card on page 23.

Table of Contents

Operational Parameters.....	4
Contents of Reverse Osmosis System.....	4
Installation & Startup	
Tools Recommended For Installation	4
Plumbing diagram and parts list.....	5
Drill a Hole for the Reverse Osmosis Faucet	6
How to use Quick Connect Fittings on Your RO System	6
Standard Faucet Installation	7
Top-Mount Faucet Installation	8
Helpful Installation Tips for the Premier Top Mount Faucet	9
Adapt-a-Valve Installation	10
Drain Saddle Installation.....	10
Drain Saddle Tube Connection.....	11
Green Tube Connection - Feed Water	12
Reverse Osmosis Module Mounting.....	12
Red 1/4" Tube Connection.....	12
Tank Ball Valve Installation	12
Blue Tube Connection - Storage Tank.....	12
Start up Instructions.....	13
Maintenance & Troubleshooting	
Six Month Maintenance	14
Annual Maintenance	15
Membrane Replacement	16
Check Air Pressure in the Tank	17
Procedure for Extended Non-Use (More than 2 months).....	17
Troubleshooting	18
Product Technical & Warranty Information	
Performance Data Sheet.....	19
Arsenic Fact Sheet	20
Other Products from Premier.....	21-22
Warranty Registration	23-24
Service Record	25
Limited Warranty	26

Operational Parameters

Installation must comply with State and local plumbing regulations. Do not use with water that is micro biologically unsafe or of unknown quality without adequate disinfection before or after the system. System is intended to be installed using the cold water supply only.

Operating Temperatures:	Maximum 100°F (37.8°C)	Minimum 40°F (4.4°C)
Operating Pressure:	Maximum 100 psi (7.0 kg/cm ²)	Minimum 40 psi (2.80 kg/cm ²)
pH Parameters:	Maximum 11	Minimum 2
Iron:	Maximum 0.2 ppm	
TDS (Total Dissolved Solids)	< 1800 ppm	
Turbidity	< 5 NTU	
Hardness	Maximum 10 Grains Per Gallon *	

Hardness: Recommended hardness not to exceed 10 grains per gallon, or 170 parts per million.

* System will operate with hardness over 10 grains but the membrane life may be shortened.

Addition of a water softener may lengthen the membrane life.

Water Pressure: The operating water pressure in your home should be tested over a 24 hour period to attain the maximum pressure. If the incoming water pressure is above 100 psi then a water pressure regulator is required. A booster pump is needed for incoming water pressure under 40psi.

Copper Tube: Reverse Osmosis water should not be run through copper tube as the purity of the water will leach copper causing an objectional taste in water and pin holes may form in the tube.

Contents of the Reverse Osmosis (RO) System

5 Stage RO System has 3 vertical bowls. 4 Stage RO System has 2 bowls.

- 1 Tank – Blue or White
- 1 Module – Blue or White (Filters Pre-Installed)
- 1 Parts Bag
- 1 Faucet Bag
- 1 Manual

If any of the items are missing please contact Premier prior to installing.



INSTALLATION & STARTUP

Tools Recommended For Installation

- √ 1 1/4" Diamond Tipped Hole Saw bit for faucet opening (Counter Tops/Porcelain & Stainless Sinks)
- √ 1 1/4" Adjustable Wrench
- √ 1/2" Open End Wrench
- √ 5/8" Open End Wrench
- √ Electric Drill
- √ 1/8" diamond tip bit, pilot hole
- √ 1/4" drain saddle hole
- √ Phillips bit for electric drill
- √ Needle Nose Pliers
- √ Adjustable Pliers
- √ Sharp Knife
- √ Phillips Screw Driver



FLOW DIAGRAM

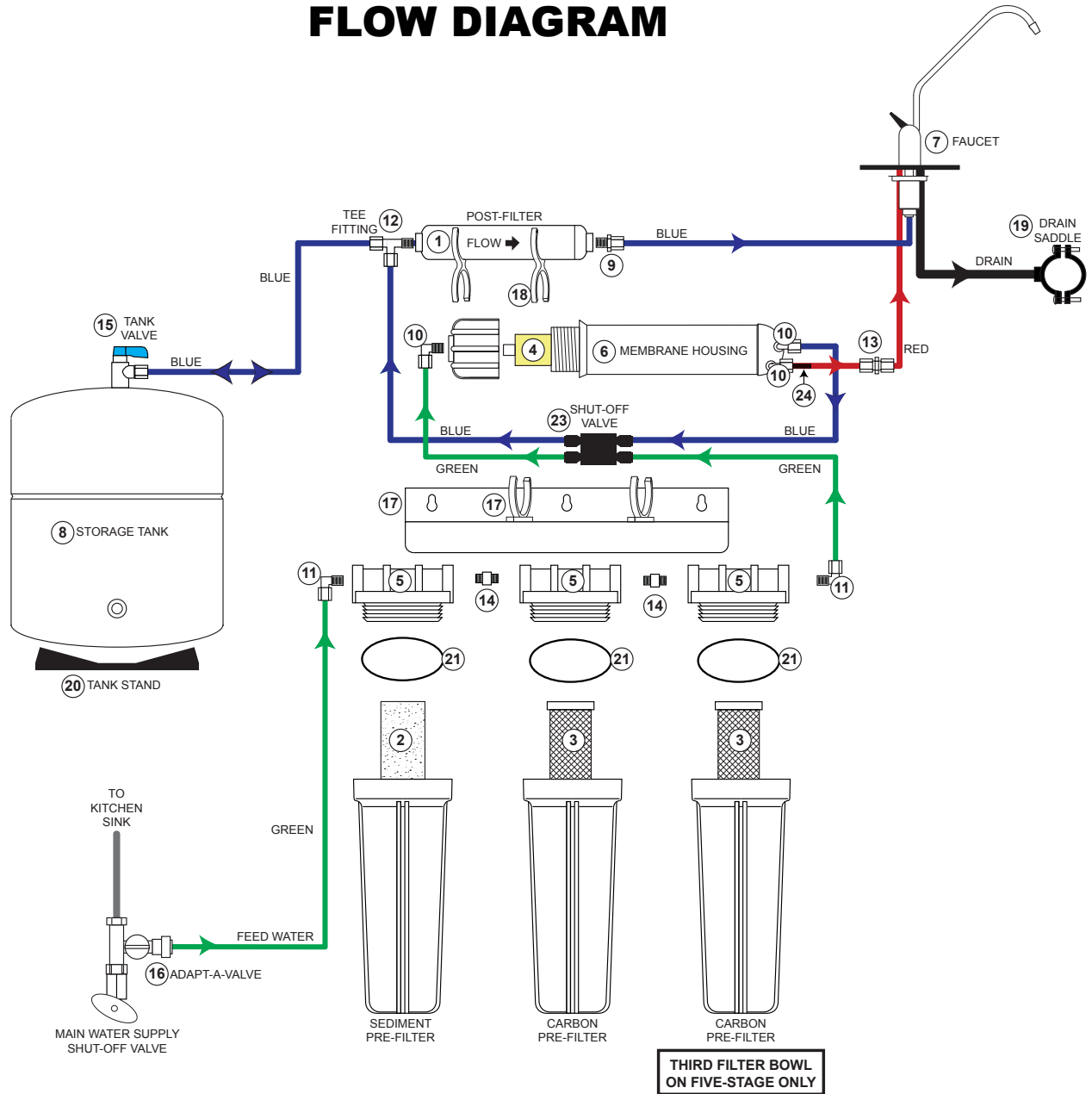

ITEM#	PART#	DESCRIPTION
1	560010	GAC INLINE FILTER - 10" - 1/4F
1 ALT	560005	GAC INLINE FILTER - 6" 1/4F
2	104017	SEDIMENT FILTER - 10" DEP - 5M
3	101009	CARBON BLOCK 10" - 5M
3 ALT	100036	GAC 10" - 56 CU IN
4	560014	24 GPD RO MEMBRANE
4 ALT	560018	50 GPD RO MEMBRANE
5	500015	HOUSINGS - BLUE/BLK 1/4 F
5 ALT	500017	HOUSINGS - WHITE/WHITE 1/4 F
6	500075	MEMBRANE HOUSING
7	116001	FAUCET - P303 - AIRGAP - CHROME
8 ALT	116094	FAUCET - TOP MOUNT - CHROME AIRGAP
8	119007	STORAGE TANK - 3 GAL - WHITE
9	125017	CONNECTOR - PLASTIC 1/4 C x 1/4 M
10	125031	ELBOW - PLASTIC - 1/4 C x 1/8 M - 90

ITEM#	PART#	DESCRIPTION
11	125034	ELBOW - PLASTIC - 1/4 C x 1/4 M - 90
12	125063	TEE - PLASTIC - 1/4 M x 1/4 C x 1/4 C
13	125041	UNION - PLASTIC - 1/4 C x 1/4 C
14	131021	HEX NIPPLE - LF BRASS - 1/4 M x 1/4 M
15	134039	TANK VALVE - 1/4 F x 1/4 C
16	560080	ADAPT-A-VALVE
17	164006	CLIP - MEMBRANE TO BRACKET
18	164010	CLIP - MEMBRANE TO INLINE FILTER
19	164056	DRAIN SADDLE - QC
20	119028	TANK STAND
21	113029	O-RING - FILTER HOUSING (560045 3-PK)
22	199348	MANUAL
23	134003	AUTOMATIC SHUT OFF VALVE
24	122008	FLOW RESTRICTOR (RED)

Drill a Hole for the Reverse Osmosis Faucet

Marble Counter-top

We recommend contacting a qualified contractor for drilling a hole in a marble counter-top.

Counter Top / Porcelain & Stainless Steel Sink

Note: Most sinks are pre drilled with 1 ¼" diameter hole that you can use for your RO faucet. (If you are already using it for a sprayer or soap dispenser, see step 1)

Porcelain sinks are extremely hard and can crack or chip easily. Use extreme caution when drilling. Premier accepts no responsibility for damage resulting from the installation of faucet. Diamond tip bit recommended.

- Step 1 Determine desired location for the RO faucet on your sink and place a piece of masking tape over where the hole is to be drilled. Mark the center of the hole on the tape.
- Step 2 Using a variable speed drill set on the slowest speed, drill a 1/8" pilot hole through both porcelain and metal casing of sink at the marked center of the desired location. Use lubricating oil or liquid soap to keep the drill bit cool (If drill bit gets hot it may cause the porcelain to crack or chip).
- Step 3 Using a 1 ¼" diamond tip hole saw, proceed to drill the large hole. Keep drill speed on the slowest speed and use lubricating oil or liquid soap to keep the hole saw cool during cutting.
- Step 4 After drilling, remove all sharp edges and make sure the surroundings of the sink are cooled before mounting the faucet.

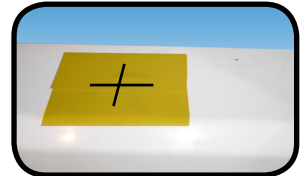

How to use the Quick Connect Fittings

To make a connection, the tube is simply pushed into the fitting. The unique locking system holds the tube firmly in place without deforming it or restricting flow. Use the steps below in reference to any quick connect tube connections.

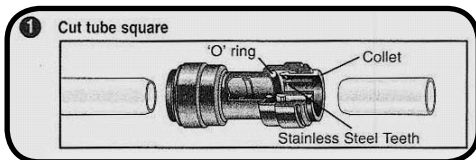

It is essential that the outside diameter be free of score marks and that burrs and sharp edges be removed before inserting into fitting.

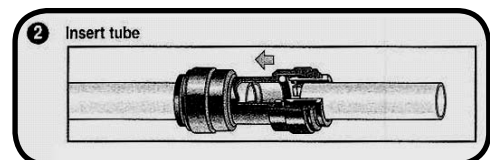

Fitting grips before it seals. Ensure tube is pushed into the tube stop.

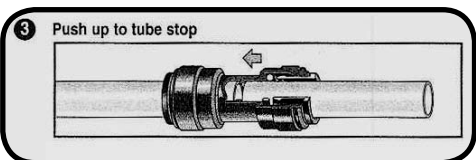

Push the tube into the fitting, to the tube stop. The collet (gripper) has stainless steel teeth which hold the tube firmly in position while the O-ring provides a permanent leak proof seal.

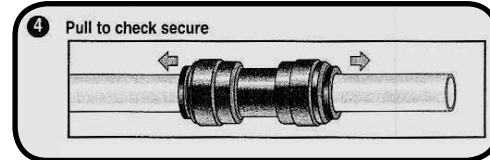

Pull on the tube to check that it is secure. It is a good practice to test the system prior to leaving site and /or before use.

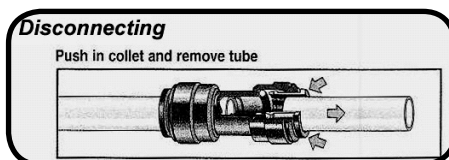

To disconnect, ensure the system is depressurized before removing the tube. Push in the collet squarely against face of fitting. With the collet held in this position, the tube can be removed. The fitting can then be reused.

Premier Standard Faucet Installation

Parts List

1. Faucet
2. Black Drain Tube (3/8" Black)
3. Red Tube 1/4"
4. Escutcheon Plate
5. Full Circle Rubber Gasket
6. Slotted Metal Washer
7. Plastic Sleeve
8. Plain Washer
9. Hex Nut Washer
10. Hex Nut
11. Plastic Tube Insert
12. White Plastic Delrin Sleeve
13. Water Connector Nut
14. Blue Tube 1/4"

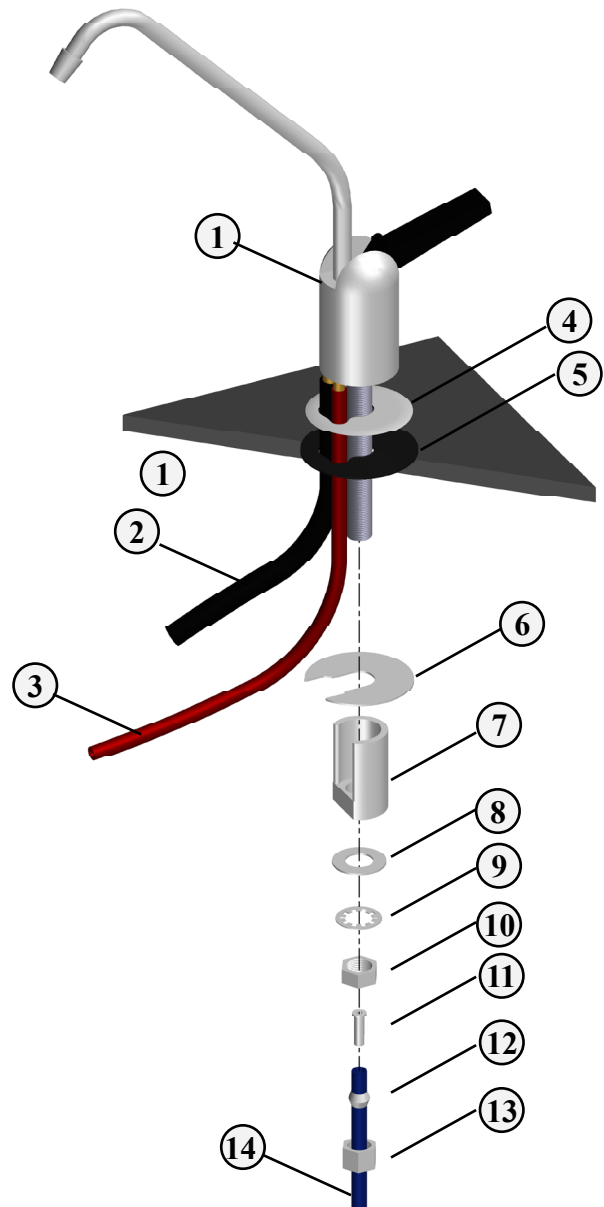

Step 5 Feed both the red and black tubing through the pre drilled hole in the sink/counter until faucet is seated.

Step 6 Under the sink - on to the threaded faucet stem in order first slide on the slotted washer (item 6), the white spacer with the open end UP (item 7), the plain washer (item 8), the hex nut washer (item 9), and lastly secure with nut (item 10).

Connect Blue Tube from the RO to the Faucet

Step 7 Locate the blue 1/4" tube attached to the RO module labeled "Faucet". Remove a brass nut, plastic sleeve and brass insert from the parts bag. To assemble, place the brass nut on the blue tube first, then the sleeve (small tapered end of sleeve must point to the end of tube) and then push the brass insert all the way into the end of the tube. (See Picture)

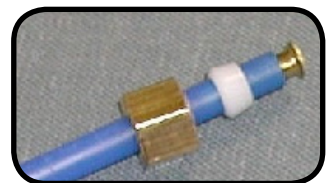

Step 8 Insert the blue tube into the end of the faucet shank and use a wrench to tighten the brass nut securely.



Premier Monitored (Top Mount) Faucet Installation

A) Connect tubes to the RO faucet (Figure A)

This RO faucet is equipped with quick connect fittings for easy tube installation. To connect tubes, simply push them *firmly* into their corresponding fitting on the RO faucet until fully seated.

Approximately 3/4" of the tube should go into the fitting.

1. Connect 3/8" **BLUE** tube (Parts Bag) (3/8" Fitting on Toggle Bolt)
2. Connect 3/8" **BLACK** tube (Parts Bag) (3/8" Fitting on base of faucet)
3. Connect 1/4" **RED** tube (Parts Bag) (1/4" Fitting on base of faucet)

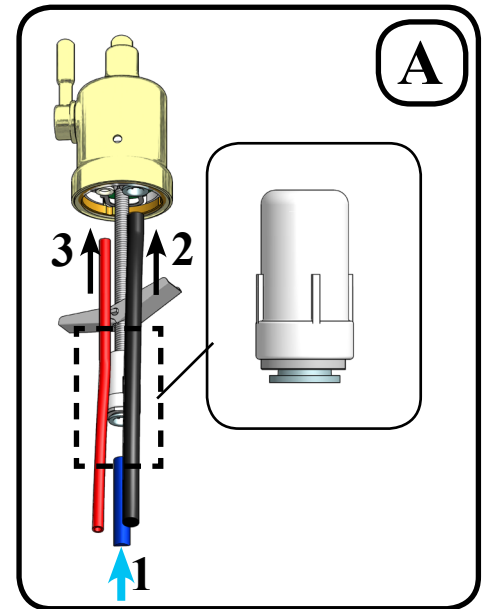

B) Mount the RO faucet (Figure B)

A 1.0" - 1.25" Mounting hole is required for faucet installation.

4. Feed the toggle bolt and tubes through the mounting hole in The sink. Test fit faucet placement.
5. Peel the white backing paper off the seal on the bottom of the faucet base and press firmly over the mounting location.
6. Using a Phillips head screwdriver torque the toggle bolt through the spout hole until the faucet is secure. **Do not overtighten!**

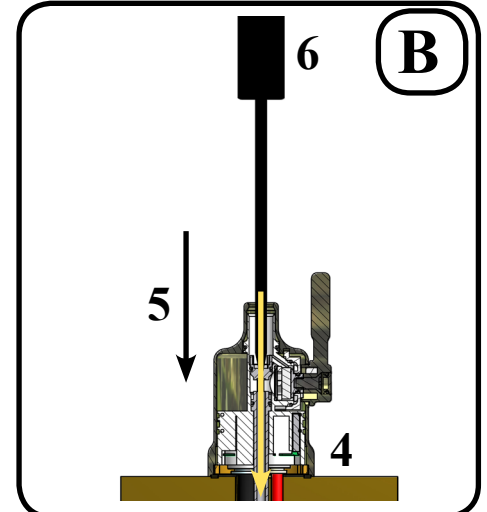

C) Pull Battery Tab and Install Spout (Figure C)

7. Insert spout into the faucet base until fully seated.
8. Pull the Battery Safety Tab out to activate faucet monitor. Make sure that the clear drawer is firmly seated in the faucet base. The monitor will flash briefly once activated.

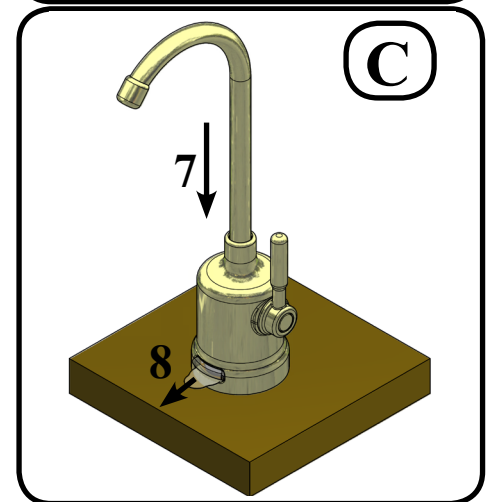

CAUTION!

“This product contains a button cell battery. If swallowed, it could cause severe injury or death in just 2 hours. Seek medical attention immediately.”

9. Determine where the 3/8" blue tubing from the faucet and the 1/4" blue tubing (marked “FAUCET”) from the RO Module would join together comfortably. Cut the tubes leaving a straight cut on both tubes. Insert the 1/4" blue tube (marked “FAUCET”) from the RO module into the 1/4" end of the 1/4" x 3/8" quick connect union supplied in the parts bag. Make sure the tube is pushed in all the way to the tube stop. Insert the 3/8" blue tube from the faucet into the 3/8" open end of the 1/4" x 3/8" quick connect union. Make sure the tube is pushed in all the way to the tube stop.

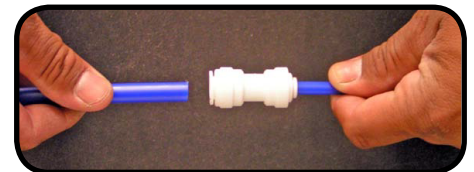

Helpful Installation Tips for the Premier Top Mount Faucet

During shipping/handling the toggle bolt on your new faucet may push up out of position. Prior to the install, hold the faucet as shown in the picture and pull down on the wing nut. This will ensure that the O-rings are in their proper position and that your faucet will have a good seal.



Disassembling your faucet is never recommended as this could void your warranty. If it is necessary to remove the fitting at the end of the toggle bolt you must follow the following procedure for re-assembly. Prior to re-connecting the fitting to the toggle bolt, you must insert the 3/8" blue tube into the fitting. There are small O-rings inside of the fitting that could be pushed out of position if the blue tube is not fully inserted first. Failure to do so may cause the faucet to leak.

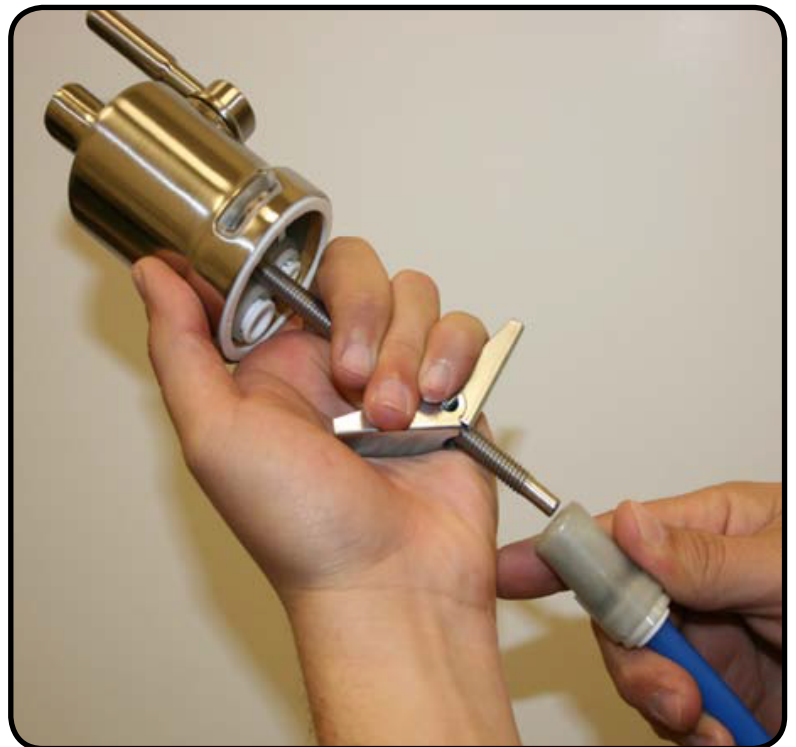

Adapt-a-Valve Installation

Caution: Water supply line to the system must be from the cold water supply line only.
Hot water will severely damage your system.

Verify contents prior to installation:

- (1) - Plastic Adapt-a-Valve with black collet
- (1) - Brass Adapter no washer
- (1) - Brass Adapter with black washer
- (1) - White rubber washer

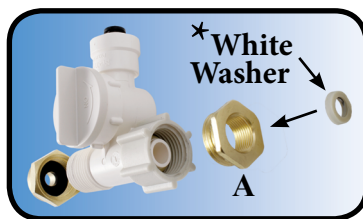
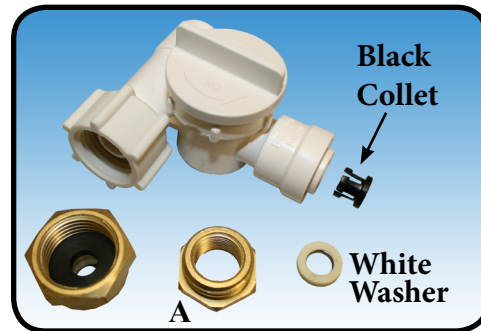

3/8" Configuration
(With Brass Fittings)
* Insert White Washer



Hot Supply Cold Supply



1/2" Configuration
(Without Brass Fittings)

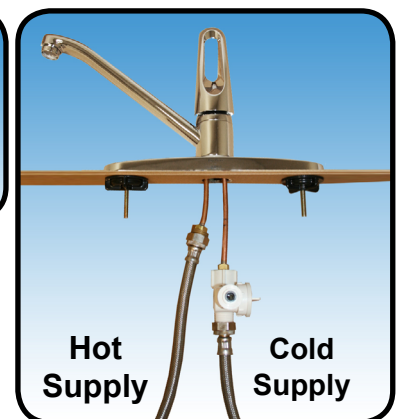

WARNING: Do not use Teflon tape with the Adapt-a-Valve.

Step 9 Turn off the cold water supply to the faucet by turning the angle stop valve completely off. Open cold water sink faucet to relieve pressure.

Step 10 Choosing the configuration that fits your plumbing, attach the adapt-a-valve as illustrated in the four photos above.

TIPS: Make sure that the black collet is installed in to the 1/4" opening on the Adapt-a-valve.
Don't forget to install the white compression washer with the 3/8" configuration.
Brass adapter (A) does not need to be tightened with a wrench, only finger tight.

Drain Saddle Installation

Drain Saddle fits standard 1 1/4" – 1 1/2" drain pipes

Caution: *If you have a garbage disposal, do not install the drain saddle near it. Installation of the drain saddle must be either above the garbage disposal, or if a second sink drain is available, install it above the cross bar on the second drain. Installation of the drain saddle near a garbage disposal may cause the drain line to plug. If no other installation of drain line is available, Premier offers drain line installation kit (part number 164020) that can be used with garbage disposals.*

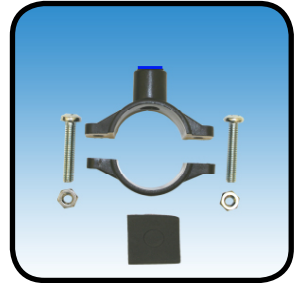

Step 11 Gather the pieces of the drain saddle:

- 1 Semicircle bracket with opening
- 2 Screws
- 2 Nuts for screws
- 1 Foam gasket
- 1 Semicircle bracket

Step 12 The small square black foam gasket with a circle cut out of the middle must be applied to the inside of the drain saddle. Remove sticky tape backing and stick to the drain saddle as shown.

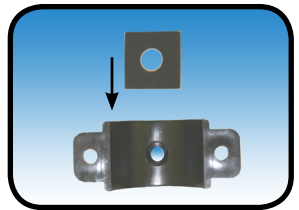

Step 13 The drain saddle must be installed at least 1 1/2" above the nut of the P-Trap elbow or cross bar from the garbage disposal to insure proper drainage. Using the 1/4" drill bit, drill into the drain pipe at best available location as specified above, for drain saddle installation. Take extreme caution to only drill through one side of the drain pipe.

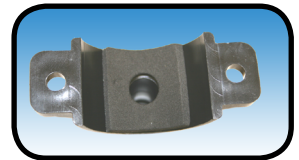

Caution: *Do not over tighten the screws. It may crack the drain saddle.*

Step 14 Assemble the drain saddle around the drain pipe and align drain saddle fitting opening with the hole drilled in the previous step - you may use a small screwdriver to feed through the drain saddle into the drain pipe to aid with the alignment. Using a Phillips screw driver tighten the drain saddle bolts evenly and securely on both sides.



IMPORTANT:

The black 3/8" drain tube must be as SHORT and STRAIGHT as possible to the drain saddle, making a downward slope from faucet to drain saddle to allow for proper drainage. This is a gravity fed line and if there is any bend or dip in the tube, the rinse water will not flow into the drain properly. Water may back up and come out the air gap hole in the back of the faucet.

Step 15 Measure the 3/8" black tube from faucet to the drain saddle on the drain pipe and make a straight cut to the correct length.

Step 16 Connect the black tube to the open quick connect fitting on the drain saddle by pushing the tube all the way to the tube stop.



Green Tube Connection

Step 17 Locate green tube attached to the RO Module. Insert the open end of the green 1/4" tube into the open 1/4" quick connect fitting on the plastic water feed valve making sure the tube is pushed in all the way to the tube stop.

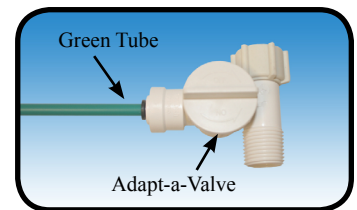

Reverse Osmosis Module Mounting

Step 18 Determine best location for the RO module to be mounted to allow for future system maintenance. Using the mounting holes on the bracket, mark the location for the mounting screws on the cabinet wall under the sink. In the parts bag, locate the two self tapping screws. Using an electric drill with a Phillips bit, screw them into the cabinet at the marked location. Hang the module on the screws using the mounting holes in the bracket



Red 1/4" Tube Connection (from faucet)

Step 19 Using the white plastic union found in the parts bag, determine where the 1/4" red tubing from the faucet and the 1/4" red tubing from the RO membrane housing would join together comfortably. Cut red tube from RO faucet to length leaving a straight cut edge. Insert the red tube from RO faucet in one end of the white plastic union and the red tube from RO membrane housing in the other end. Use a 5/8" wrench to tighten both of the white plastic nuts securely.

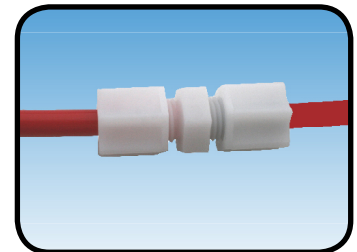

Tank Ball Valve Installation

Step 20 Teflon tape must be applied in a clockwise direction. Wrap (7 to 12 turns) around the male pipe threads (MPT) on the stainless steel fitting on top of the tank.

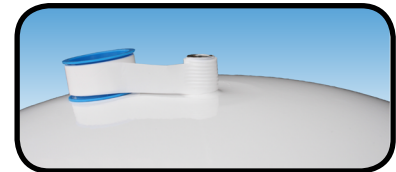

Step 21 Thread the elbow ball valve (supplied in the parts bag) onto the stainless steel connector on the tank.

Note: Do not over-tighten plastic connections.



Blue Tube Connection (From The Tank to Shut off Valve)

Step 22 Position tank in desired location. Stand it upright or lay it on its side (using the black plastic stand). Measure the blue tube (marked "TANK") from the RO module to the tank and cut it to length leaving a straight, square edge. To connect the blue tube to the ball valve fitting, slip the blue tube through the white compression nut, hand tighten the white nut and add 1/4 turn with a wrench.

Note: Set the blue ball valve knob in-line with the blue tube, this is the "open" position.

Congratulations!

You have completed the installation of your new Reverse Osmosis system.

Please Follow the Startup Instructions.

Start up Instructions

- Step 1 Turn on the incoming cold water at the angle stop valve and the Adapt-a-Valve. Check the system for leaks and tighten any fittings as necessary. (Check frequently over the next 24 hours to ensure no leaks are present).

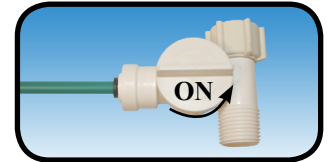

Note: *If you have connected your RO system to a refrigerator / ice maker, make sure the ice maker is off (do not allow water to flow to the ice maker) until flushing (Step 4) is complete and the tank has been allowed to fill completely. Connection from the RO to the ice maker system should have an in-line valve installed before the ice maker so it can easily be closed to prevent water flowing to the ice maker during start up and periodic maintenance. Your storage tank must be allowed to fill up fully in order for the ice maker system to work properly.*

- Step 2 Open the RO faucet and leave it open until water begins to trickle out (this may take a few minutes and the water will come out slowly).

- Step 3 Close the RO faucet allowing the storage tank to fill with water. It may take 3 to 6 hours to fill the tank completely depending on the production capability of the membrane, local water temperature and water pressure.

Note: *During the fill period you may hear water trickling which is a normal occurrence.*

- Step 4 After the storage tank has filled open the RO Faucet to flush the tank completely. You will know that the tank is empty when the flow rate from the RO faucet is down to a trickle. Repeat this step two more times. The fourth tank can be used for drinking.

The flushing process should take about a day to complete.

Note: *Flushing of the tank 3 times is only necessary during the initial startup and after replacing the membrane.*

Don't Forget To Register!

Register by phone, fax, mail or internet. Premier uses this information only to provide you with a filter change reminder service. Pre-filters should be changed every 6 months and the final in-line filter annually. You may register your system via our web site at www.premierh2o.com or call 1-800-752-5582 (within USA only) / FAX#: 623-866-5666. For Warranty card Please see page 25-26.

MAINTENANCE & TROUBLESHOOTING

6 Month System Maintenance

*Order filters by calling 1-800-752-5582 or buy online at www.premierh2o.com.

Items needed:

√ Stage 1 - Sediment Filter (part #: 104017)

√ Stage 2 & 3 - Carbon Block Filter (part #: 101009-White End Caps)

Note: *The filter wrench pictured (Part # 164003) may be purchased from Premier to aid with twisting off filter housings (not required).*

Step 1 Close the tank Ball valve.

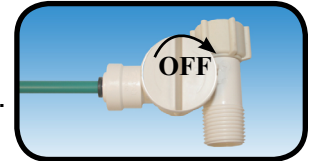

Step 2 Turn off the incoming water supply to the RO at the feed water valve. (Follow the green tube away from the RO system to find the valve.)

Step 3 Open RO Faucet to depressurize system before attempting to remove filter housings, this may take a few minutes.

Step 4 For more leverage you may leave the RO module attached to wall of cabinet. If you are unable to access the module while it is mounted, remove it prior to changing filters. Starting with the closest housing (Stage 1), remove it by turning it clockwise (left), empty water, then discard filter. Continue on to the 2nd housing (Stage 2) and 3rd housing (Stage 3).



Note: *If you own a four stage system it will not have the third stage. A four stage system has two vertical housings instead of three.*

Step 5 Clean the filter housings (bowls) with a mild soap solution and rinse with water. Check O-rings and lubricate with water soluble lubricant. KY Jelly® or other water based lubricants may be used. Petroleum based lubricants (such as Vaseline®) must not be used.



Caution: *Before re-installing the filter bowls back on to the system, check O-rings to make sure they are still in place. **

Step 6 Insert a new sediment filter (cloth like appearance) into the 1st filter housing which is the one on the water inlet side (green tubing from the feed water valve) of the RO system and re-install housing.



Step 7 Insert the new Carbon Block filter (White end caps & plastic netting) into the second and third filter bowls and re-install housings.

Step 8 Turn on the water supply to the unit at adapt-a-valve.

Step 9 Keep the RO faucet open until water begins to trickle out (it will come out slowly).

Step 10 Close the RO faucet and open tank ball valve.



Annual Maintenance

*Order filters by calling 1-800-752-5582 or buy online at www.premierh2o.com.

- √ Stage 1 - Sediment Filter (part #: 104017)
- √ Stage 2 & 3 - Carbon Block Filter (part #: 101009-White end caps)
- √ Stage 5 - 10" Final Polishing filter (part # 560010)
- √ 1/2 Cup of hydrogen peroxide or common household bleach.

Note: *Sanitizing of unit is recommended.*

Step 1 Perform steps 2 through 5 in the Six Month System Maintenance (Page 14).

Note: *If not sanitizing the system skip to step 8.*

Step 2 Remove the RO membrane from its housing and rest in a clean sanitary place. (Refer to "Membrane Replacement" section on page 16 for directions on removing the membrane). Replace cap onto empty membrane housing and re-connect green tubing.

Step 3 Leaving the filters out, replace stage 2 and 3 empty filter housings (hand tight) onto unit. Measure & pour either 1/2 cup of hydrogen peroxide or common household bleach into the 1st filter housing (Stage 1) and hand tighten onto unit.

Step 4 With the RO faucet in the closed position turn on the incoming water supply to the system. Wait 1 minute for the unit to pressurize. Turn on the RO faucet and let the water run for 30 seconds. Turn off the RO faucet and let the unit rest for 2 minutes. Finally, open the RO faucet and let the water run for 5 more minutes.

Step 5 Turn off the incoming water supply to the system. Keep the RO faucet open until the storage tank is completely drained.

Step 6 Open the membrane housing and re-install the RO membrane while making sure not to kink the O-rings. (Refer to "Membrane Replacement" section on page 16 for directions on installing the membrane). Tighten the cap back on the housing and reconnect green tubing.

Step 7 Remove filter housings Stage 1, 2 and 3 and empty of water.

Caution: *Before re-installing the filter bowls back on to the system, check O-rings to make sure they are still in place and lubricate with water soluble lubricant.*

Step 8 Insert the new sediment filter (cloth like appearance) into the 1st filter housing which is the one on the water inlet side (green tubing from the adapt-a-valve) of the RO system and re-install housing.

Step 9 Insert the new Carbon Block filter (White End Caps) into the 2nd and 3rd housing and re-install housing.

Step 10 The final in-line filter is located on the blue tube between the storage tank and the RO faucet. Remove it by loosening the compression fittings on both ends of the filter and replace with new filter. (Discard used final filter after sanitizing)

Note: *The arrow on the final filter must be pointing towards the RO faucet / away from the RO storage tank.*

Tip: *This is a good time to check the air pressure in your storage tank. For instructions please see page 17.*

Step 11 Follow Steps 8 through 10 in the Six Month System Maintenance (Page 14) for startup directions.

This reverse osmosis system contains a replaceable component (the RO membrane) which is critical to the efficiency of the system. Replacement of this reverse osmosis membrane should be with one of identical specifications as defined by Premier to assure the same efficiency and contaminant reduction performance.

Membrane Replacement

Membranes have a life expectancy between 2 and 5 years, depending on the incoming water conditions and the amount the RO system is used. This reverse osmosis membrane is critical for effective reduction of total dissolved solids (TDS). The product water should be tested periodically to verify that the system is performing satisfactorily.

Normally, a membrane would be replaced during a semiannual or annual filter change. However, if at any time you notice a reduction in water production or an unpleasant taste in the reverse osmosis water, it could be time to replace the membrane. Premier recommends replacing the membrane when TDS reduction falls below 75%.

Note: *A water sample may be sent to Premier for a free diagnosis of your membrane performance. To send a water sample, use two (2) clean containers and fill ½ cup of tap water in one container and ½ cup of reverse osmosis water in 2nd container. Clearly label each sample. Send the samples to the address listed on the cover of this manual attention “Water Samples”. Premier will test the water and mail or call you with the results.*

Step 1 Turn off the incoming water supply to the RO.

Step 2 Open the RO Faucet and allow water to drain from the tank until it is completely empty.

Removing the membrane:

Step 3 Use a 5/8” wrench to remove the Green Tube fitting on the left side of the horizontal membrane housing (end with one elbow).

Step 4 Remove the cap from the membrane housing by turning it counter clockwise to loosen.

Note: *A double sided wrench may be purchased from Premier to aid with loosening the cap / filter housings. (Part # 164003)*

Step 5 Remove membrane housing from the holding clips. Using a pair of pliers, grip the PVC tube of the RO membrane and pull firmly on the membrane to remove from the housing and discard.

Installing the membrane:

Step 6 Lubricate the O-rings on the new membrane with a water soluble lubricant such as KY Jelly ®. Insert the end with the two black O-rings first into the housing.

Step 7 Once membrane has been inserted into the housing you must take your thumbs and give a firm push to properly seat the membrane. Replace membrane housing cap and tighten.

Step 8 After replacing membrane housing into clips, attach the green tube to the elbow on cap using 5/8” wrench.

Step 9 Follow the Start Up Instructions on page 13.

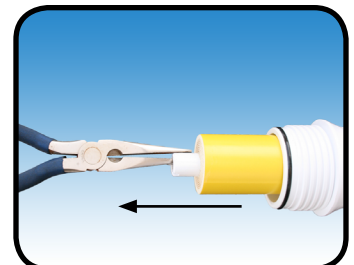
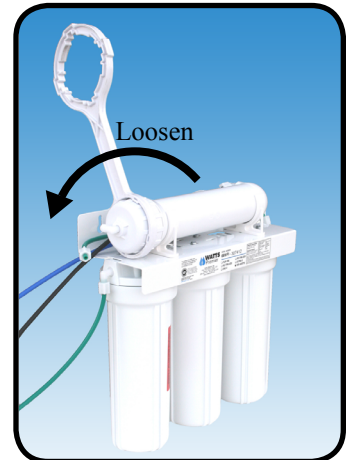

Check Air Pressure in the Tank

Important: Check air pressure only when tank is empty of water!

Check air pressure in the storage tank when you notice a decrease in available water from the RO system. Air can be added with a bicycle pump using the schrader valve that is located on the lower side of the tank behind the blue plastic cap.

Step 1 Turn off the incoming water supply to the RO.

Step 2 Open the RO Faucet and allow water to drain from the tank until it is completely empty.



Tip: When water from the RO faucet slows to a trickle, with the faucet still in the open position, you may add air to the tank to purge any left over water, this will ensure that the tank is completely empty.

Step 3 Once all water in the tank is purged, check air pressure using an air pressure gauge, it should read between 5 - 7 PSI. (Digital air pressure gauge is recommended)

Step 4 Follow startup procedure on page 13.

Procedure for Extended Non-Use (More than 2 months)

Turn off the water supply and open the RO faucet to empty the storage tank (Save a few ounces of RO water). Once the storage tank is empty, remove the membrane and place it in a sealed plastic bag with the RO water saved earlier and store in your refrigerator.

DO NOT FREEZE.

For restart, reinstall membrane (See page 16 for membrane installation procedure) and follow startup procedure on page 13.

TROUBLE SHOOTING

Problem	Cause	Solution
1. Low/Slow Production	<p>Low Water Pressure</p> <p>Crimps in tubing Clogged pre-filters Fouled membrane</p>	<p>Assure a minimum of 40 psi incoming water pressure. Premier sells a booster pump if home water pressure is low. Make sure water supply is turned on and feed water valve is all the way open.</p> <p>Check tubing and straighten or replace as necessary. Replace pre-filters. Replace membrane.</p>
2. Milky colored Water	Air in system	Air in the system is a normal occurrence with initial start up of the RO system. This milky look will disappear during normal use within 1-2 weeks. If condition reoccurs after filter change, drain tank 1 to 2 times.
3. Water constantly running, unit will not shut off	<p>Low water pressure</p> <p>Crimp in supply tube High water pressure</p> <p>High pressure in Tank</p> <p>Low Pressure in Tank</p>	<p>See #1 Above</p> <p>Check tubing and straighten or repair as necessary. Check incoming water pressure to make sure it does not exceed 80 psi. A pressure relief valve may be necessary.</p> <p>Empty storage tank of water. Set tank air pressure between 5-7 psi. See previous page.</p> <p>Use a Digital Air Gauge for best results. The empty tank pressure should be 5-7 psi. See page 78.</p>
4. Noise / Water from faucet vent hole or noise from drain.	<p>Crimp or restriction in drain line</p> <p>Drain tube clogged</p>	<p>Check tubing and straighten or repair as necessary. Straighten all drain lines. Clear blockage. Cut off any Excess tubing</p> <p>Caused from dishwasher or garbage disposal. Disconnect the 3/8" black line at the drain, clean the 3/8" black line out with a wire, then reconnect. Blowing air through the line will not always remove the clog.</p>
5. Small amount of water in storage tank	<p>System starting up</p> <p>Low water pressure To much air in tank</p>	<p>Normally it takes 4-6 hours to fill tank. Note: low incoming water pressure and/or temperature can drastically reduce production rate.</p> <p>See #1 above.</p> <p>Tank air pressure should be 5-7 psi when empty of water. If below 5 psi add air or bleed if above 7 psi. Check only when tank is empty of water. See previous page.</p>
6. Water leaks from the blue or white filter housing	<p>Not properly tightened</p> <p>Kinked O-ring</p>	<p>Tighten the bowl.</p> <p>Turn off the water supply and release the pressure. Replace the O-ring if necessary. Then lubricate it and make sure the O-ring is seated in the filter bowl properly before reinstalling the filter bowl.</p>
7. Low water flow from faucet	Check air pressure in tank	Use a Digital Air Gauge for best results. The empty tank pressure should be 5-7 psi. See page 17.

TECHNICAL & WARRANTY INFORMATION

Premier Inc.
8716 W Ludlow Drive Suite #1
Peoria, AZ 85381
California Certification # 00-1452

5 SV Deluxe, CRO-TFM-5SV, Ultra 5 and Pur-Tek, Premier 25, Premier RO-4, Premier RO-5, RO-TFM-4SV, RO-TFM-5SV System conforms to NSF Standard 58 for specific claims.

GENERAL USE CONDITIONS:

1. System to be used with municipal or well water sources treated and tested on regular basis to insure bacteriological safe quality. DO NOT use with water that is micro biologically unsafe or unknown quality without adequate disinfection before and after the system. Systems certified for cyst reduction may be used on disinfected water that may contain filterable cysts.
2. Operating Temperature: Maximum: 100°F (40.5°C) Minimum: 40° (4.4°)
3. Operating Water Pressure: Maximum: 100 psi (7.0kg/cm2) Minimum: 40 psi (2.8kg/cm2)
4. pH 2 to 11
5. Maximum iron present in incoming feed water supply must be less than 0.2 ppm.
6. Hardness of more than 10 grains per gallon (170 ppm) may reduce membrane life expectancy.
7. Recommend TDS (Total Dissolved Solids) not to exceed 1800 ppm.



RECOMMENDED REPLACEMENT PARTS AND CHANGE INTERVALS:

Note: Depending on incoming feed water conditions replacement time frame may vary.

Description	Change time Frame	Cost
Sediment Pre-filter: #104017	6 Months	\$ 3.50
Carbon Pre-filter: #101009	6 Months	\$10.50
Final Carbon filter #100017	12 Months	\$9.50
R.O. Membrane: #110009	2 to 5 years	\$59.95

* All Prices Subject to change without notice

This system has been tested according to NSF/ANSI 58 for reduction of the substances listed below. The concentration of the indicated substances in water entering the system was reduced to a concentration less than or equal to the permissible limit for water leaving the system as specified in NSF/ANSI 58. This system has been tested for the treatment of water containing pentavalent arsenic (also known as As (V), As (+5), or arsenate) at concentrations of 0.30 mg/L or less. This system reduces pentavalent arsenic, but may not remove other forms of arsenic. This system is to be used on water supplies containing a detectable free chlorine residual at the system inlet or on water supplies that have been demonstrated to contain only pentavalent arsenic. Treatment with chloramine (combined chlorine) is not sufficient to ensure complete conversion of trivalent arsenic to pentavalent arsenic, Please see the Arsenic Facts section of the Performance Data Sheet for further information.

	Avg. In. (mg/L)	Avg. Eff. (mg/L)	% Reduction	pH	Pressure	Max Eff. mg/L	Inf. challenge concentration mg/L	Max Allowable concentration mg/L
Arsenic (Pentavalent)	334.62 ug/L	5.039 ug/L	98.4%		50psi	19 ug/L	0.30±10%	0.010 mg/L
Barium Reduction	10.2	0.13	98.7%	7.24	50psi	0.27	10.0±10%	2.0
Cadmium Reduction	0.031	0.0001	99.7%	7.49	50psi	0.0009	0.03±10%	0005
Chromium (Hexavalent)	0.30	0.006	98.0%	7.24	50psi	0.013	0.03±10%	0.1
Chromium (Trivalent)	0.30	0.003	99.0%	7.24	50psi	0.008	0.03±10%	0.1
Copper Reduction	3.0	0.04	98.7%	7.64	50psi	0.06	3.0±10%	1.3
Cysts	222,077#/ml	10 #/ml	99.99%		50psi	58	minimum 50,000/mL	N/A
Fluoride Reduction	8.0	0.33	95.9%	7.49	50psi	0.47	8.0±10%	1.5
Lead Reduction	0.15	0.004	97.3%	7.49	50psi	0.008	0.15±10%	0.0107
Radium 226/228	25pCi/L	5pCi/L	80.0%	7.24	50psi	5pCi/L	25pCiL±10%	5pCiL
Selenium	0.10	<0.001	99.0%		50psi	<0.001	0.10±10%	0.05
TDS	760	85	88.0%	5.94	50psi	100	750±40mg/L	187
Turbidity	81 NTU	0.15 NTU	99.8%		50psi	0.28 NTU	11±1 NTU	0.5 NTU

Recovery - 18.0%

Daily Production Rate - 11.0 GPD

Efficiency - 10.4%

Depending on water chemistry, water temperature, and water pressure Premier's R.O. Systems production and performance will vary. Efficiency rating means the percentage of the influent water to the system that is available to the user as reverse osmosis treated water under operating conditions that approximate typical daily usage. Recovery rating means the percentage of the influent water to the membrane portion of the system that is available to the user as reverse osmosis treated water when the system is operated without a storage tank or when the storage tank is bypassed. There is an average of 4 gallons of reject water for every 1 gallon of product water produced.

REFER TO OWNER'S INSTALLATION/SERVICE MANUAL FOR FURTHER MAINTENANCE REQUIREMENTS AND WARRANTY INFORMATION.

Phone: (480) 675-7995

Fax: (623) 866-5666

Email: wpmail@Premier.com

Arsenic Fact Sheet

Arsenic (As) is a naturally occurring contaminant found in many ground waters. Arsenic in water has no color, taste or odor. It must be measured by an arsenic test kit or lab test.

Public water utilities must have their water tested for arsenic. You can obtain the results from your water utility contained with in your consumer confidence report. If you have your own well, you will need to have the water evaluated. The local health department or the state environmental health agency can provide a list of test kits or certified labs.

There are two forms of arsenic: pentavalent arsenic (also called As (V), As (+5)) and trivalent arsenic (also called As (III), As (+3)). In well water, arsenic may be pentavalent, trivalent, or a combination of both. Although both forms of arsenic are potentially hazardous to your health, trivalent arsenic is considered more harmful than pentavalent arsenic.

RO systems are very effective at removing pentavalent arsenic. A free chlorine residual will rapidly convert trivalent arsenic to pentavalent arsenic. Other water treatment chemicals such as ozone and potassium permanganate will also change trivalent arsenic to pentavalent arsenic. A combined chlorine residual (also called chloramine) where it does convert trivalent arsenic to pentavalent arsenic, may not convert all the trivalent arsenic in to pentavalent arsenic. If you get your water from a public water utility, contact the utility to find out if free chlorine or combined chlorine is used in the water system.

This Premier reverse osmosis system is designed to remove up to 98% of pentavalent arsenic. It will not convert trivalent arsenic to pentavalent arsenic. Under laboratory standard testing conditions, this system reduced 0.30 mg/L (ppm) pentavalent arsenic to under 0.010 mg/L (ppm) (the USEPA standard for drinking water). Actual performance of the system may vary depending on specific water quality conditions at the consumer's installation. In addition to the independent laboratory standard testing conditions Premier has conducted additional field testing on our reverse osmosis units to determine trivalent arsenic reduction capabilities. Based upon Premier field testing, it has been determined that the RO units are capable of reducing up to 67% of trivalent arsenic from the drinking water.

The RO membrane component of this Premier reverse osmosis system must be maintained according to its recommended maintenance cycle. Specific component identification and ordering information can be found in the installation/operation manual maintenance section, by phone at 1-800-752-5582 or online www.premierh2o.com

California Proposition 65 Warning

WARNING: This product contains chemicals known to the State of California to cause cancer and birth defects or other reproductive harm.

For more information: Watts.com/prop65

Other Products from Premier

Premier has other fine water filtration products and accessories to enhance your water and to compliment your existing RO System. Listed on the next several pages are only a few of the items we offer. Visit our web site at www.premierh2o.com or call our Customer Service Representatives at 1-800-752-5582 (inside USA) 1-480-675-7995 (outside USA) for more products.

Premier offers a filter change kit which includes all replacement filters needed. Call 1-800-752-5582 or buy on-line at www.premierh2o.com.



Top Mount Faucets by Premier

These attractively designed faucets feature a long reach spout to compliment all styles of kitchen decor. The unique top mount design allows for easy above counter installation. The Monitored version of this faucet has an LED light that turns red to notify you for filter replacement.

Part No. 116091 - Chrome (Non-Monitored)	*\$47.95 each
116095 - Brushed Nickel (Non-Monitored)	*\$52.95 each
116094 - Chrome (Monitored)	*\$57.95 each
116093 - Brushed Nickel (Monitored)	*\$62.95 each



Ice Maker Installation Kit

1/4 inch connection kit includes 30 feet of 3/8" tubing, ball valve, and fittings.

Part No. 500010	*\$16.95/ea
-----------------	-------------



Premier Hot Water Recirculation System

Bring convenience and saving to your home, giving you hot water instantly at every faucet, when you need it. This unique product is easy to install and not only provides you with the convenience of hot water when you need it, but saves an average of over 15,000 gallons per year.

Part No. 500800	*\$229.99 each
-----------------	----------------

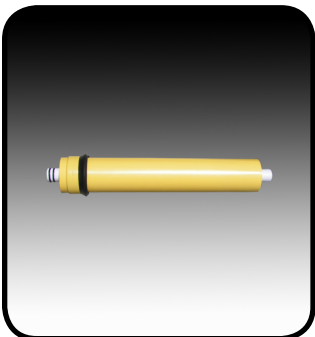

50 GPD Membrane

Compatible with Premier Reverse Osmosis systems, this 50 GPD membrane generates a greater amount of water per day for your RO system. Good application for households with higher levels of Nitrites & Nitrates. Contact Premier if you are in need of a Nitrite/Nitrate test kit.

Part No. 560018 (Membrane)	*\$ 80.95/ea
----------------------------	--------------

***All prices subject to change without notice.**

Removing chlorine from your shower

Special Chlorgon & KDF media – More effective than carbon medias with hot water applications in the removal of the following.

- √ Free Chlorine (CL-)
- √ Combined Chlorine (Sodium Hypochlorite)
- √ Hydrogen Sulfide (Rotten egg smell)
- √ Plus, its pH balanced.
- √ Iron oxide (rust water)
- √ Dirt, sediment
- √ Odors



Deluxe Shower Handle with Built in Filter

5-Way Massaging Spray
72" Reinforced Hose
High Strength Bracket
Triple Plated Finish
Reversible Filter Cartridge (Model HHC)
Cartridge Life Rating: 3 months

Part No. 107070 WHITE *\$38.95
Part No. 107091 CHROME *\$44.95
Part No. 107092 GOLD *\$44.95

Replacement filters 2PK



Part No. 107075 *\$15.95/pk



Shower Falls Deluxe Shower Handle with Built in Filter

Curved Ergonomic Shower Handle
Filter Handle Extension
Dual Swivel Adjustment
Ultra Deluxe 5 Way Massaging Spray
72" Reinforced Hose
Chrome Plated Brass Bracket & Swivel Ball Extension
Triple Plated Finish
Reversible Filter Cartridge (Model HHC)
Cartridge Life Rating: 3 months

Part No. 107095 CHROME *\$55.95

Replacement filters 2PK



Part No. 107075 *\$15.95/pk



All-In-One reversible High-Flow Filter

Deluxe 5-Way Massaging Spray

Soft-Touch Adjustment Pads
Anti-Scaling Spray Nozzle
High Strength Housing
Triple Plated Finish
Cartridge Life Rating: 6 months

Part No. 107098 White/Chrome *\$39.95

Replacement filter



Part No. 107080 *\$13.95/ea

***All prices subject to change without notice.**

WARRANTY REGISTRATION

Thank you for selecting Premier for your water filtration needs.

4 Ways to Register

1. On-line at www.premierh2o.com

Register your product on-line and receive a 5% discount on your next on-line order, Plus receive reduced shipping.

2. Call in your information 1-800-752-5582

Call and we will enter your information.

3. Fax in your information 623-866-5666

Fax this form directly to us.

4. Mail in the information.

Please complete the form below. Mail to: **Premier
8716 W Ludlow Drive Suite #1
Peoria, AZ 85381**

Registering will insure you receive Premier **FREE** Filter Reminder Service

Premier Inc. is concerned for the safety of your personal information. Premier collects personal information when you register with Premier. This information is stored in our data base and we do not rent, sell, or share personal information with other people or nonaffiliated companies. We reserve the right to send you certain types of communications such as direct mail, email, or by telephone relating to our products or products that you have purchased. We limit access to your personal information to those employees who will directly provide you with services or products in order to do their jobs. We want to offer you four ways to communicate with us. 1.Online, 2.Fax, 3.Telephone, and 4. Mail the form below. By registering your product you will receive the full benefit of our warranty. Premier will also send you a semiannual filter change reminder beginning six months from date of installation. To insure the highest quality of your water, filters should be replaced every 6 months. If you have any questions or comments please give us a call at 1-800-752-5582 M-F 8:00am -5:00pm MST.



First Name: _____ Last Name: _____

Address: _____ City: _____

State: _____ Zip Code: _____

Country: USA CANADA MEXICO OTHER _____

Phone # _____ - _____ - _____ Email Address: _____

Date of Purchase: _____ Date of Install: _____

Installed By: SELF Plumbing Professional Where Purchased: _____

Model Number: _____ Serial Number: _____ - _____
XXXXXX - XXXXXX

Premier, Inc.
Phone: 800-752-5582

8716 W Ludlow Drive Suite #1
www.premierh2o.com

Peoria, AZ 85381
Fax: 623-866-5666

WARRANTY REGISTRATION

Please Fill out and keep for your Records

First Name: _____ Last Name: _____

Address: _____ City: _____

State: _____ Zip Code: _____

Country: USA CANADA MEXICO OTHER _____

Phone # _____ - _____ - _____ Email Address: _____

Date of Purchase: _____ Date of Install: _____

Installed By: SELF Plumbing Professional Where Purchased: _____

Model Number: _____ Serial Number: _____ - _____
XXXXX - XXXXXX

Iowa Department of Public Health - Sales in Iowa require this to be completed, signed and returned.
These signatures will be retained on file for two years.

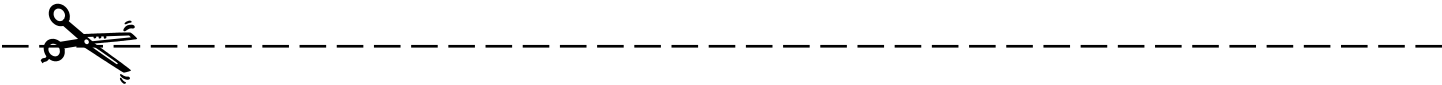

Insert into envelope and return to Premier

Premier
8716 W Ludlow Drive Sutie #1
Peoria, AZ 85381

Service Record

Date of Purchase: _____ Date of Install: _____ Installed by: _____

Date	1st stage Sediment (6 months)	2 nd stage Carbon (6 months)	3rd stage Carbon (6 months)	Final Filter Carbon (1 year)	TFM Membrane (2-5 years)

NOTES:

Limited Warranty

What your Warranty Covers:

If any part of your Premier Reverse Osmosis System is defective in workmanship (excluding replaceable filters and membranes), return unit after obtaining a return authorization (see below), less tank, within 3 years of original retail purchase, Premier will repair or, at Premier's option, replace the system at no charge.

How to obtain Warranty Service:

For warranty service, call 1-800-752-5582 for documentation and a return authorization number. Once the return authorization number has been created, ship your Reverse Osmosis unit (less tank) to our factory, freight and insurance prepaid, with proof of date of original purchase. Include a note stating the problem experienced and include your name, address and your return authorization number. No returns will be accepted without the proper return authorization number. Premier will repair it, or replace it, and ship it back to you prepaid.

What this warranty does not cover:

This warranty does not cover defects resulting from improper installation, (contrary to Premier's printed instructions), from abuse, misuse, misapplication, improper maintenance, neglect, alteration, accidents, casualties, fire, flood, freezing, environmental factors, water pressure spikes or other such acts of God.

This warranty will be void if defects occur due to failure to observe the following conditions:

1. The Reverse Osmosis System must be hooked up to a potable municipal or well cold water supply.
2. The hardness of the water should not exceed 10 grains per gallon, or 170 ppm.
3. Maximum incoming iron must be less than 0.2 ppm.
4. The pH of the water must not be lower than 2 or higher than 11.
5. The incoming water pressure must be between 40 and 85 pounds per square inch.
6. Incoming water to the RO cannot exceed 105 degrees F (40 degrees C.)
7. Incoming TDS/Total Dissolved Solids not to exceed 1800 ppm.
8. Do not use with water that is micro biologically unsafe or of unknown quality without adequate disinfection before or after the system.

This warranty does not cover any equipment that is relocated from the site of its original installation.

This warranty does not cover any charges incurred due to professional installation.

This warranty does not cover any equipment that is installed or used outside the United States of America and Canada.

LIMITATIONS AND EXCLUSIONS:

Premier WILL NOT BE RESPONSIBLE FOR ANY IMPLIED WARRANTIES, INCLUDING THOSE OF MERCHANTABILITY AND FITNESS FOR A PARTICULAR PURPOSE. PREMIER WILL NOT BE RESPONSIBLE FOR ANY INCIDENTAL OR CONSEQUENTIAL DAMAGES, INCLUDING TRAVEL EXPENSE, TELEPHONE CHARGES, LOSS OF REVENUE, LOSS OF TIME, INCONVENIENCE, LOSS OF USE OF THE EQUIPMENT, AND DAMAGE CAUSED BY THIS EQUIPMENT AND ITS FAILURE TO FUNCTION PROPERLY. THIS WARRANTY SETS FORTH ALL OF PREMIER'S RESPONSIBILITIES REGARDING THIS EQUIPMENT.

OTHER CONDITIONS:

If PREMIER chooses to replace the equipment, Premier may replace it with reconditioned equipment. Parts used in repairing or replacing the equipment will be warranted for 90 days from the date the equipment is returned to you or for the remainder of the original warranty period, whichever is longer. This warranty is not assignable or transferable.

YOUR RIGHTS UNDER STATE LAW:

Some states do not allow limitations on how long an implied warranty lasts, and some states do not allow the exclusion or limitation of incidental or consequential damages, so the above limitations or exclusions may not apply. This warranty gives you specific legal rights, and you may have other legal rights which vary from state to state.