

CUBE PLUS

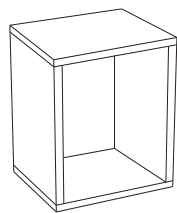

Included



8 Pins



2 Vertical zBoards
adhesive strips on 2 edges

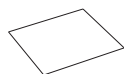

1 Backer Board
thin and has no adhesive

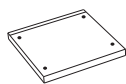

2 Horizontal zBoards
with grooves

 **WARNING: CHOKING HAZARD**
Small parts NOT for children under 3 years

Important

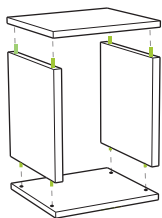

↑
THIS SIDE UP

Tip Start assembly from bottom to top.

DO NOT place unit on its side or back as it will compromise its structural integrity.



- Assemble your unit on a flat even surface, carpet not recommended
- Furniture is for indoor use only

- When moving your Way Basics furniture, lift from the bottom
- Make sure zBoard surfaces are clean and dry

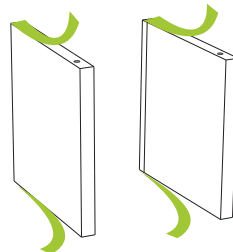

1 Carefully remove the 3M protective layer from adhesive.

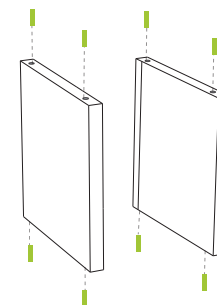

2 Place alignment pins in vertical zBoards.

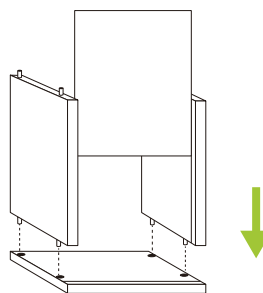

3 Align vertical zBoards and backer board to horizontal zBoard.

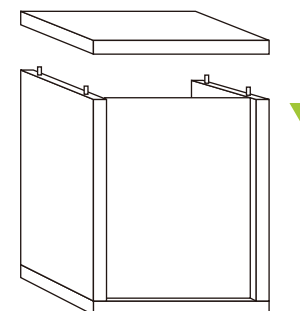

4 Align horizontal zBoard and press down firmly to secure unit together. Visit links below for more details. Enjoy building possibilities!

