

# HPIC11 & HPIC18

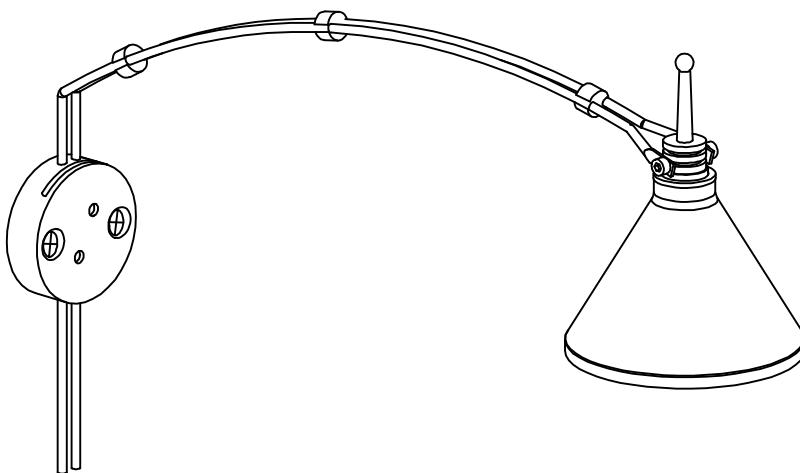

①

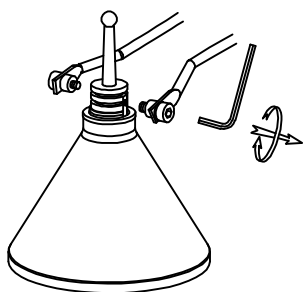

Screws must always be tight.  
Loose screws will cause arching  
and melting of socket.  
Les vis doivent demeurer serrées.  
Des vis desserrées causeront la  
déformation et la fonte de la douille.

**BULB / AMPOULE**  
50W Max MR16/CG HPIC18  
20W Max MR16/CG HPIC11  
(included / inclus)  
C/w covered glass.  
Vient avec une vitre de protection.

②

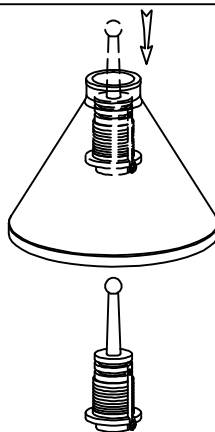

③

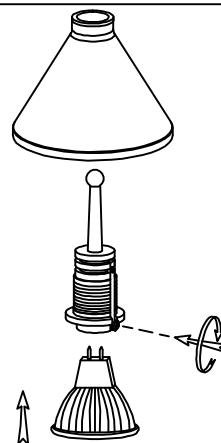

④

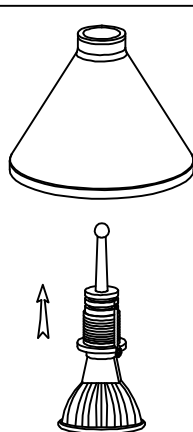

⑤

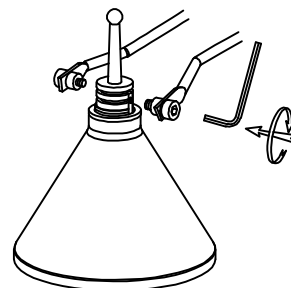



1401 Courtney Park Dr. E Mississauga, Ontario, Canada L5T 2E4  
Tel. (905) 564-1262 Fax. (905) 564-1299  
E-Mail: dainolite@dainolite.ca Web: www.dainolite.ca

## HARDWARE MOUNTING INSTRUCTIONS

- 1) CONNECT THE 120-VOLT LEADS FROM THE TRANSFORMER TO YOUR POWER LEADS IN THE ELECTRICAL BOX
- 2) PLACE THE TRANSFORMER IN THE ELECTRICAL BOX.
- 3) MOUNT THE CROSSBAR TO THE ELECTRICAL BOX
- 4) CONNECT THE 12-VOLT LEADS FROM THE TRANSFORMER TO THE LEADS COMING OUT OF THE CANOPY.
- 5) MOUNT THE CANOPY TO THE CROSSBAR WITH THE 1/4-20X3/4" SCREW SUPPLIED.
- 6) CONNECT LEADS COMING OUT OF THE CANOPY TO THE BANANA CONNECTOR ON THE MOUNTED PICTURE LIGHT.

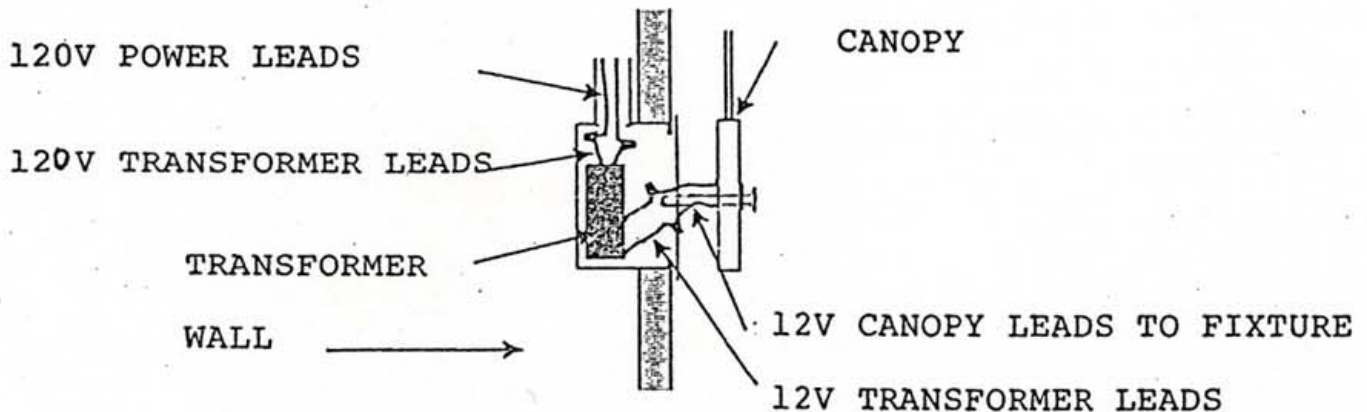

### HW-VERSION

