

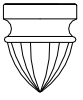

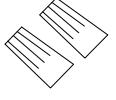



Fixture Name: Mayfair 7116-17 LC

This fixture assembled PO: \_\_\_\_\_ Date: \_\_\_\_\_

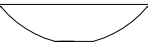
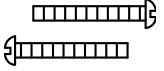
**Notice:** Please review the parts listing and check for all parts before assembling the fixture. If any parts are missing or damaged, please note on this sheet and contact the place of purchase to arrange for replacement parts.

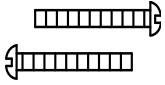
PARTS LIST		Company Name: _____ Co. Account #: _____ to be filled out by retailer	
Mounting strap 1ea W3-7/8"*E1"*10mm 	Finial 1ea 1/8-27-IP*H39mm 	Wire connectors 3ea P3 Orange 	
Hex Nut 1ea 1/8-IP*H4mm 	Bottom cap 2ea Ø3-1/4"*H25mm 	Mounting Screws 2ea 8#32-IP*1" 	
Nipple 2ea 1/8-IP*H135mm 	Mounting Screws 2ea 5/32-IP*50 		
Hex Nut 2ea 5/32-IP*H3mm 	Metal washer 1ea 	Plastic washer 1ea 	
Part Needed _____		Quantity _____	
Part Needed _____		Quantity _____	
Reason why _____	( missing, scratched, broken glass, bent, bad finish)		
Comments _____			

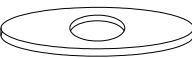
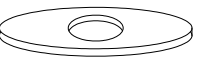
## FIXTURE ASSEMBLY INSTRUCTIONS

**Read and review installation instruction sheet before assembling the fixture.**

1. Thread the Nipple (K) into the Ceiling pan (J) coupler and secure with Hex nut attached.
2. Install the light bulbs in accordance with the fixture's specifications.
3. Place the Glass shade (L) over the Ceiling pan (J) allowing the Nipple (K) to protrude through the bottom hole in the glass. Place the Plastic washer (M) and Metal washer (N) over the Nipple (K) tighten with Hex Nut (O), slide Bottom cap (P) over Nipple (K) and tighten with Finial (Q)

\*a cover (M) may be included in place of the metal and plastic washers

(DO NOT EXCEED MAXIMUM WATTAGE RATING!)

**NOTE: INSTALL THE GLASS ASSEMBLY AFTER THE FIXTURE IS HUNG.**

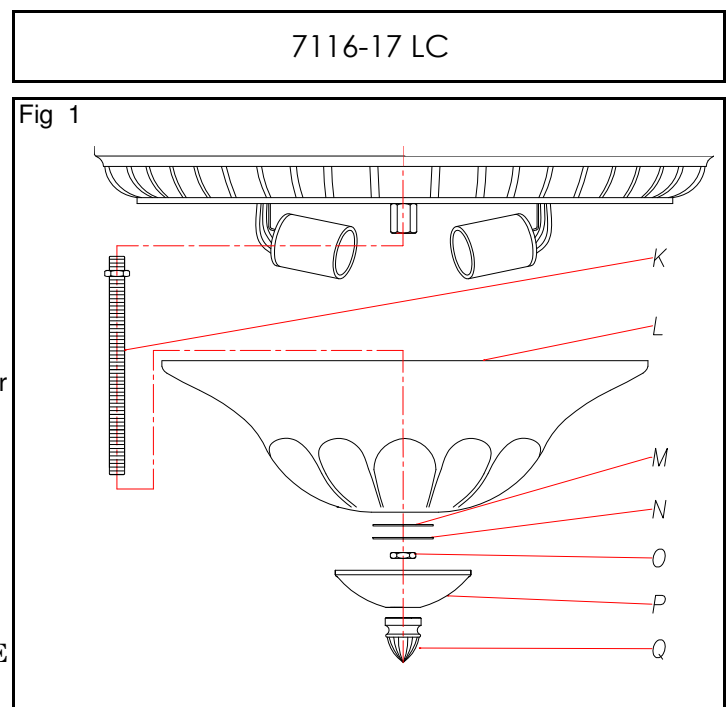

For Customer Service, contact the place of purchase to arrange for replacement parts.

## WARNING ! SHUT OFF POWER AT FUSE OR CIRCUIT BREAKER.

### HANGING THE FIXTURE (Fig 1)

1. Carefully remove the new fixture from the carton and the yellow bag that holds all your parts. Check that all parts are included as shown in the illustration and parts list.
2. Shut off power at the circuit breaker and remove the old fixture from ceiling, including the old mounting strap.
3. Thread the two Fixture Mounting Screws ( G ) into the pre-drilled Holes in the Mounting Strap ( E ) spaced the same distance apart as the holes in the Ceiling Pan. Secure in place with Hex nuts ( F ).
4. Attach Mounting Strap ( E ) to the junction box using the two Mounting Screws ( D )

### CONNECTING THE WIRES (Fig 2)

5. Attach the power supply wires to the fixture lead wires by connecting BLACK to BLACK (or SMOOTH) and WHITE to WHITE (or RIBBED).
6. Attach the GROUND wire (GREEN or COPPER) from the Junction Box and the fixture Ground wire to the green Ground Screw ( L ) on the Mounting Bracket ( E ) or connect both wires together using the correct size of wire connectors. NOTE: Twist the wires together in the same direction you twist the wire connector onto the wires.
7. Tuck these wire connections neatly into the Junction Box.

### FINISHING THE INSTALLATION (Fig 3)

8. Finish mounting the Ceiling Pan ( J ) by placing it over the Mounting Strap ( E ). Rotate the Pan until the Mounting screws ( G ) protrude through the "Keyholes" located in the bottom of Ceiling Pan ( J ). Using a screw driver, secure the Ceiling Pan ( J ) by screwing Mounting Screws ( G ) until taut.
  9. Install the light bulbs in accordance to the fixture's specifications.
  10. Install the glass shade as per the assembly instructions.
- YOUR INSTALLATION IS NOW COMPLETE.  
RETURN POWER TO THE JUNCTION BOX AND TEST THE FIXTURE.

Fig. 1

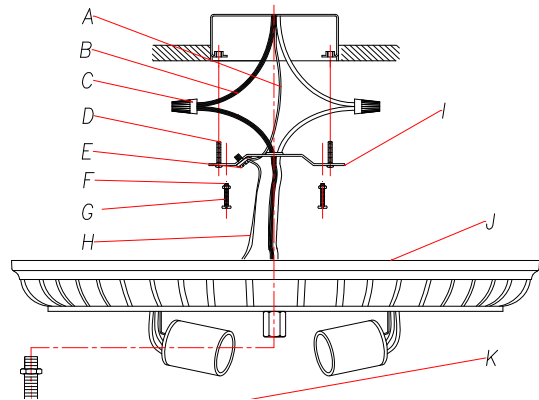

Fig. 2

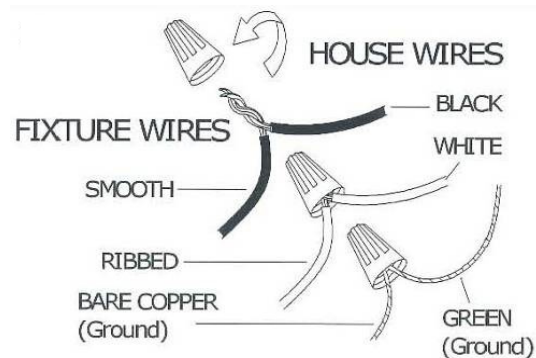

Fig. 3

