



CICATRICES DE LUXE 8

INSTRUCTION FOR CORRECT INSTALLATION AND USE

WARNING!

The safety of this appliance can only be guaranteed if these instructions are followed during installation and use. Therefore, please keep a copy of these instructions for later reference. Make sure the mains power supply has been disconnected before installing the appliance or carrying out any work on it. To assure that the appliance functions correctly and safely, it must be connected to an efficient earthing system.

Fig. 1 Unhook the rose (A); carry out the electrical connections then connect the fixing plate (B) to the junction box using the 2 screws (C). (Use expansion nogs (D) as reinforcements if necessary. N:B: choose the expansions nogs most suited to the surface used in the assembly); Fix the lamp body (E) to the fixing plate (B) using the two screws (F). Replace the rose (A) into position and check that the magnets (G) have connected.

Fig. 2 Insert the light bulbs in their respective bulb sockets.

Fig. 3 Assemble the diffusers by screwing them in clockwise; be careful to comply with the references indicated on the body of the appliance near the bulb sockets and on the diffuser vases.

TECHNICAL DATA

Low pressure UV STOP incandescent halogen light bulbs: MAX 35W 12V;
Gy 6.35 socket.

CLEANING INSTRUCTIONS

Make sure the mains power supply has been disconnected.

Only clean the main body with a soft cloth which can be dampened with soap and water or a neutral detergent to remove persistent dirt. Thoroughly dry the entire surface before reconnecting the mains power supply.

The diffuser vases can be washed in a dishwasher and/or with a bottle brush.

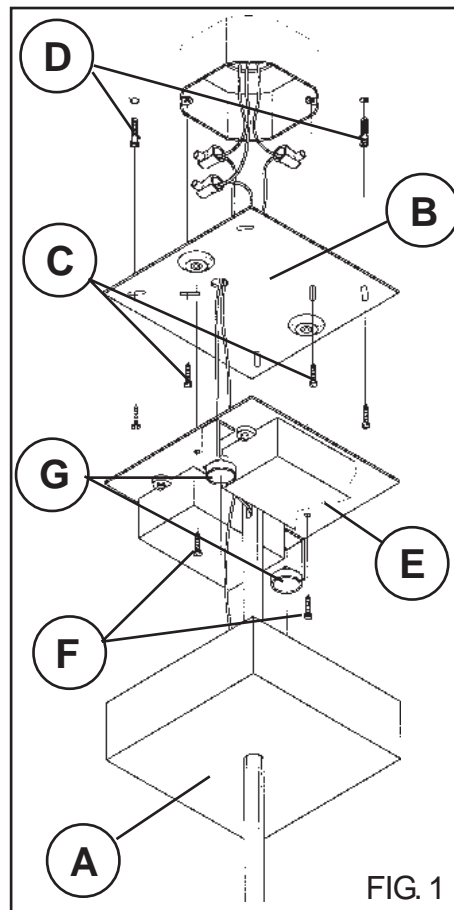

FIG. 1

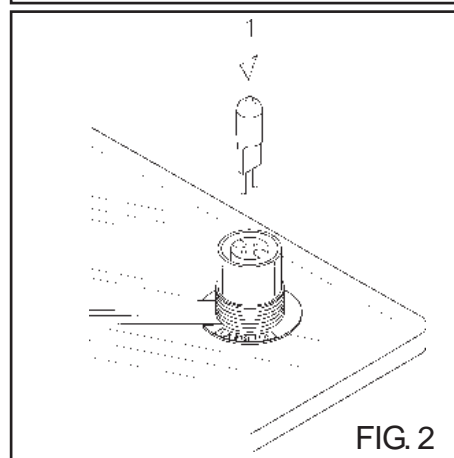

FIG. 2

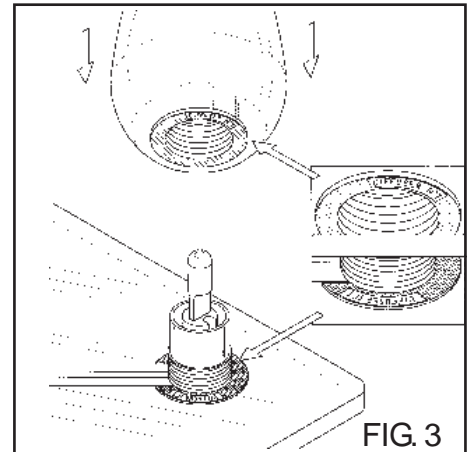

FIG. 3

