

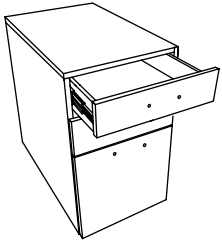

Component List

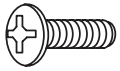

A - Cabinet x 1



B - 5/32" x 12mm
Phillips Screw x 20

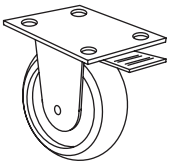

C - Brake Caster x 2

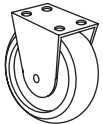

D - Center Caster x 1

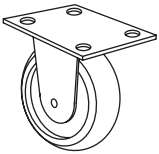

E - Rear Caster x 2

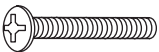

F - 5/32" x 22mm
Phillips Screw x 6



G - Drawer Pull x 3



H - Legal File Folder
Stretchers x 2

Your Sequel Home Office Furniture is engineered for easy assembly. Carefully follow this procedure to prevent any damage.

Placement and Maintenance

Sequel Home Office Furniture is designed for indoor use on level floors. Clean steel parts and wood veneer with a moist cloth.

Step 1 Unpack and Identify

Unpack and identify the components at left. Note that some components are shipped inside the cabinet. The assembly workspace should be a non-marring surface such as carpet. A Phillips Screwdriver will be needed for assembly. For missing hardware pieces, please contact BDI Customer Service at customerservice@bdiusa.com. For all other concerns, please contact your BDI Retailer.

Step 2 Install Casters

Carefully position **Cabinet (A)** on its top surface so that the bottom surface is up, then attach a **Caster** to each of the five (5) exposed installation plates using **5/32" x 12mm Phillips Screw (B)** and a Phillips Screwdriver.

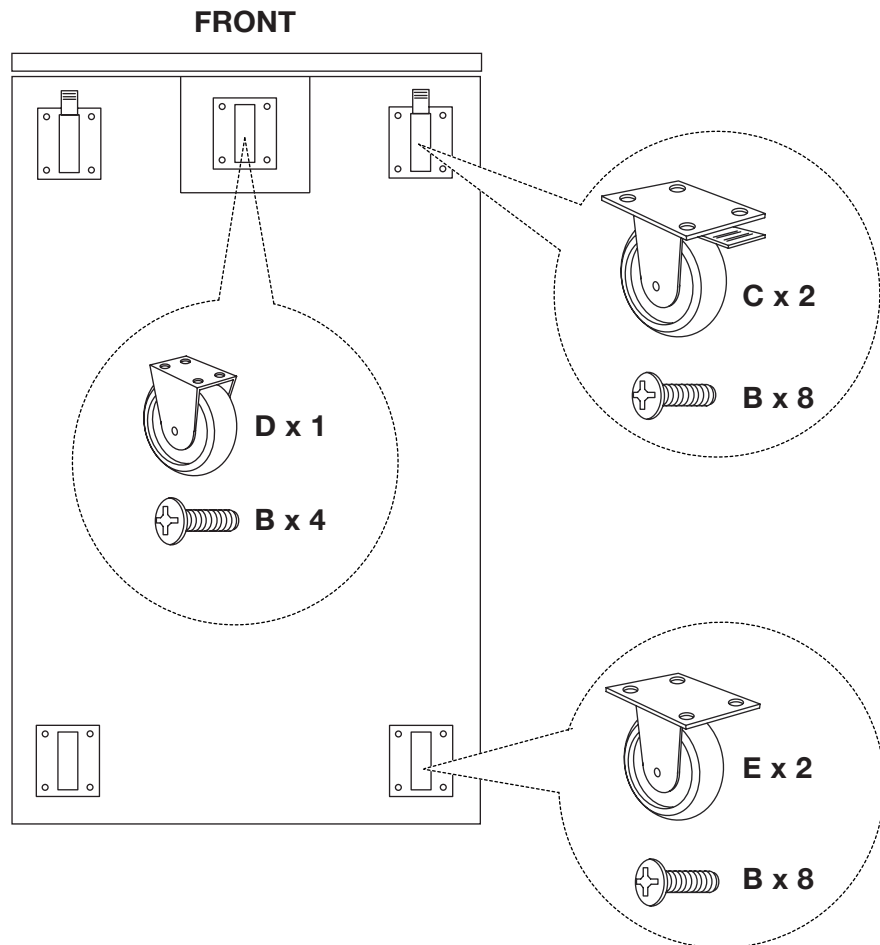

Step 3 Install Handles.

Carefully turn pedestal upright so that it rests evenly on all installed casters, then install one **Drawer Pull (G)** per drawer using the **5/32" x 22mm Phillips Screw (F)** and a Phillips Screwdriver.

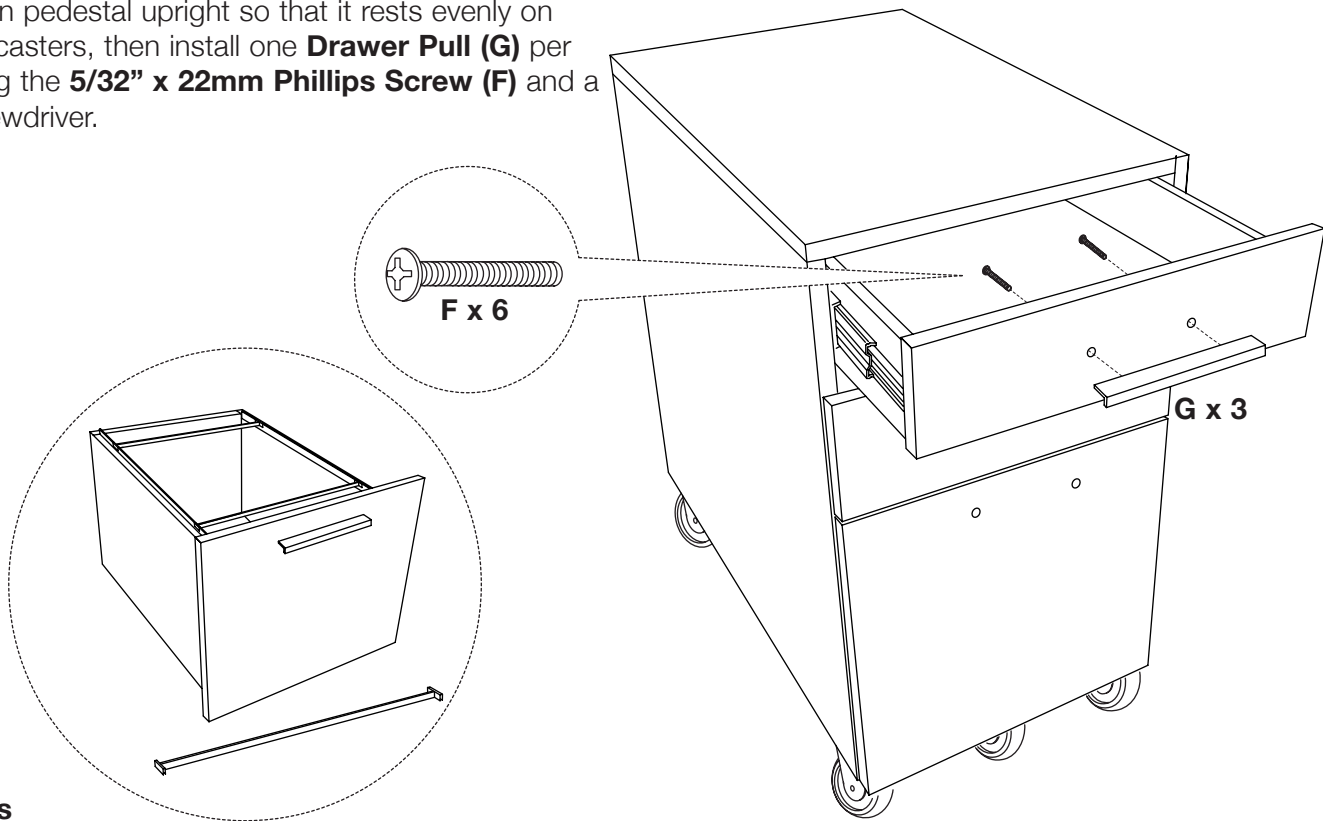

File Folders

Users who wish to use legal-length files may install provided **Legal File Folder Stretchers (H)** by dropping into place near front and back of the file drawer.