



**ETAGERE - 71"H / PRESENTOIR OUVERT
CAPPUCCINO**

**BOOKCASE - 71"H / CAPPUCCINO OPEN CONCEPT
DISPLAY ETAGERE**

I 2541

**INSTRUCTIONS D'ASSEMBLAGE
ASSEMBLY INSTRUCTIONS**



**POUR DE L'ASSISTANCE OU POUR COMMANDER
DES PIÈCES CONTACTEZ NOTRE DÉPARTEMENT
DE SERVICE À LA CLIENTÈLE.**

**FOR ASSISTANCE OR TO ORDER PARTS
CONTACT OUR CUSTOMER SERVICE DEPARTMENT**

WWW.MONARCHSERVICE.COM

IDENTIFICATION DES PIÈCES
PARTS IDENTIFICATION

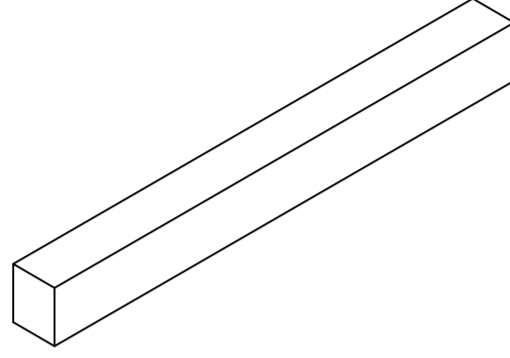
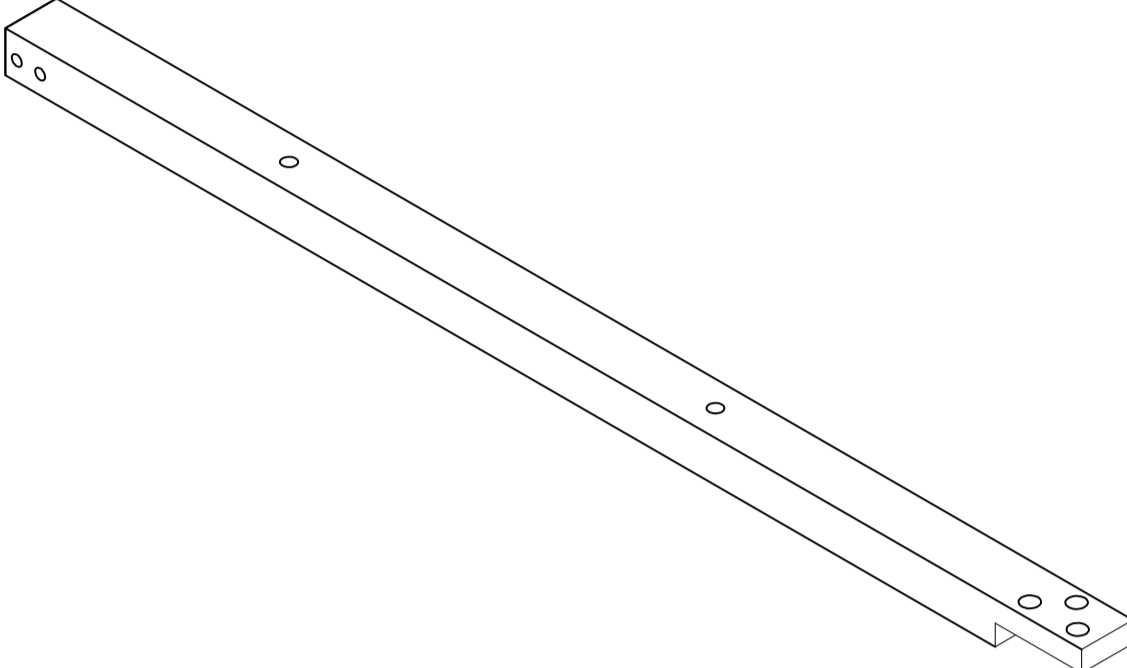
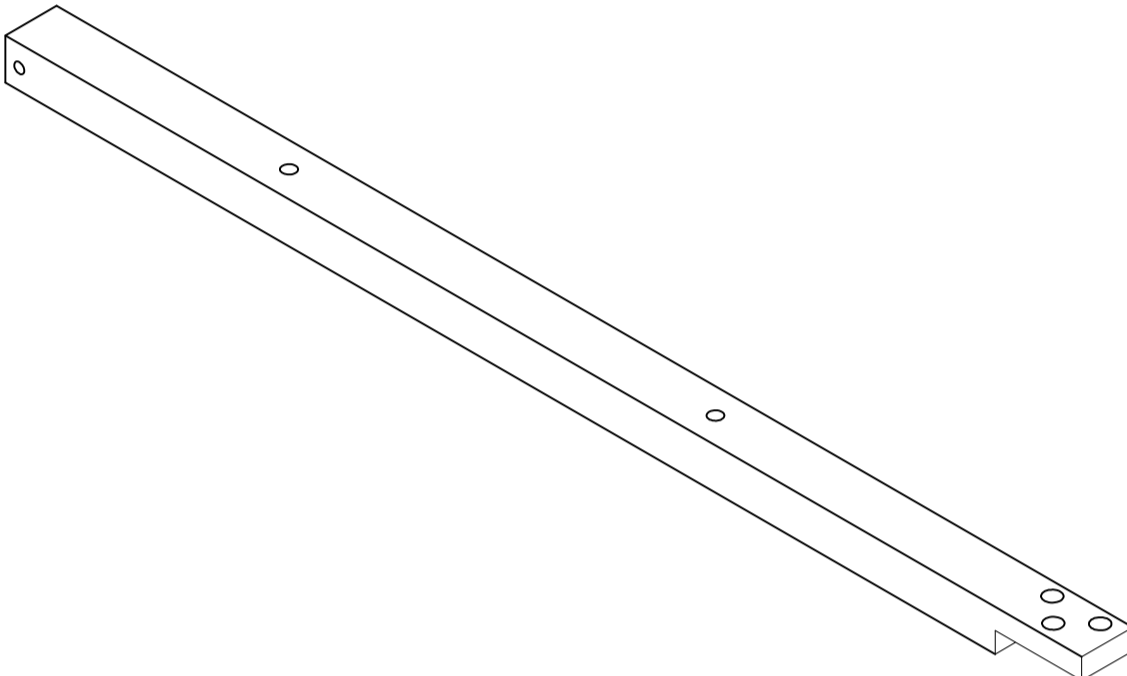
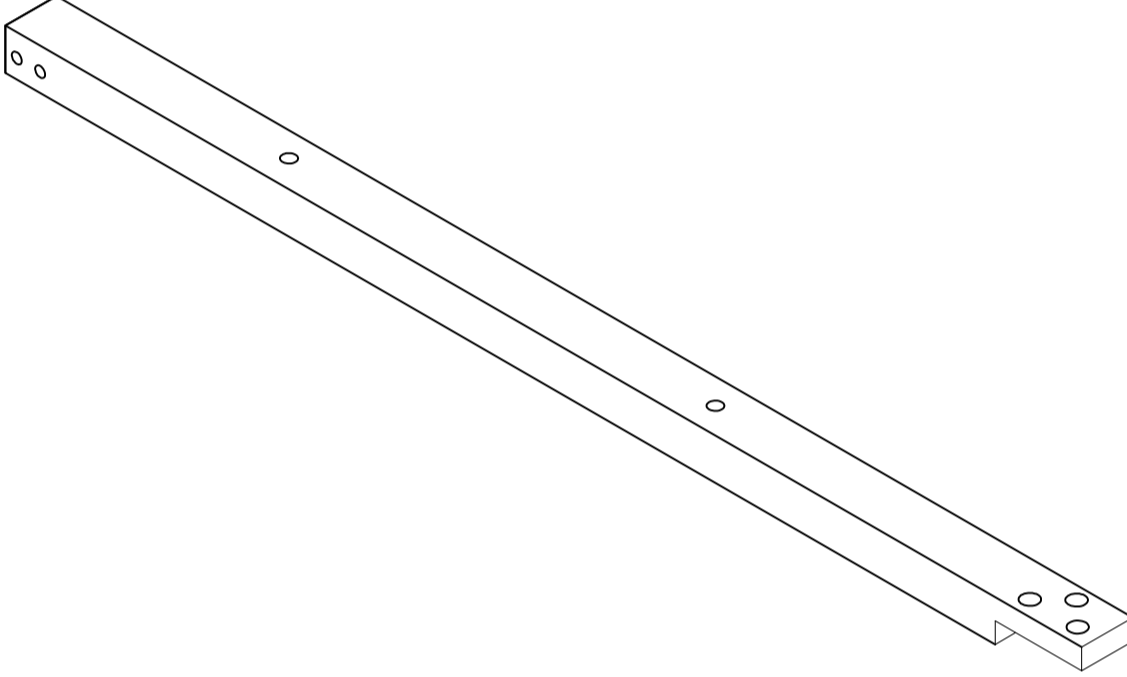
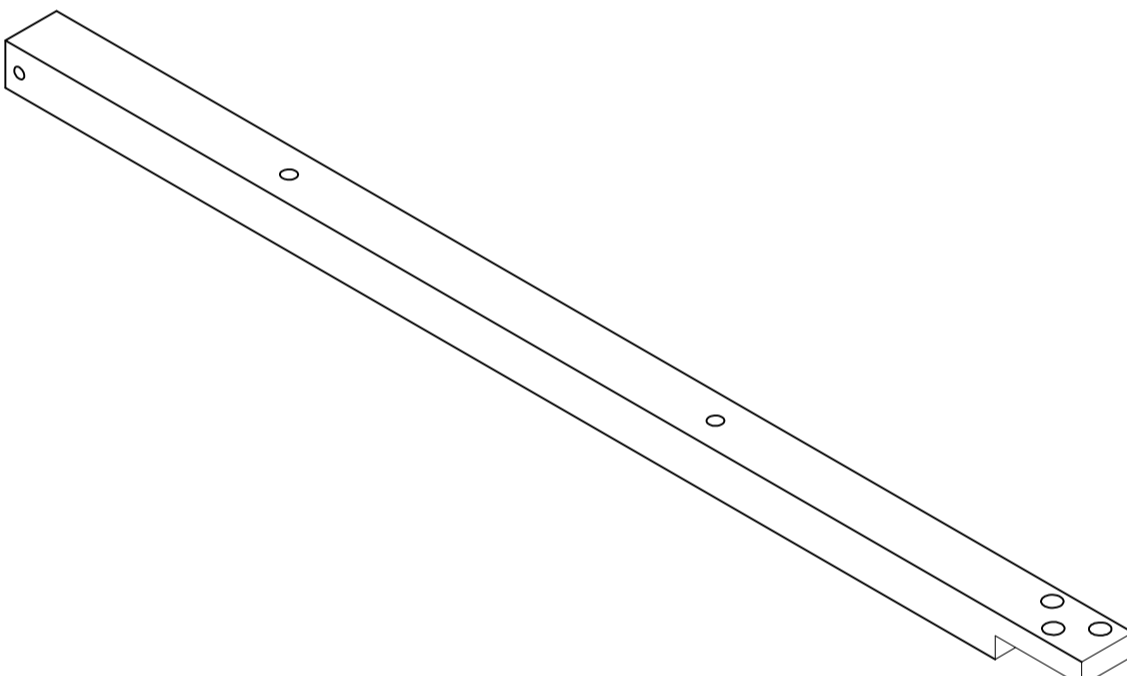
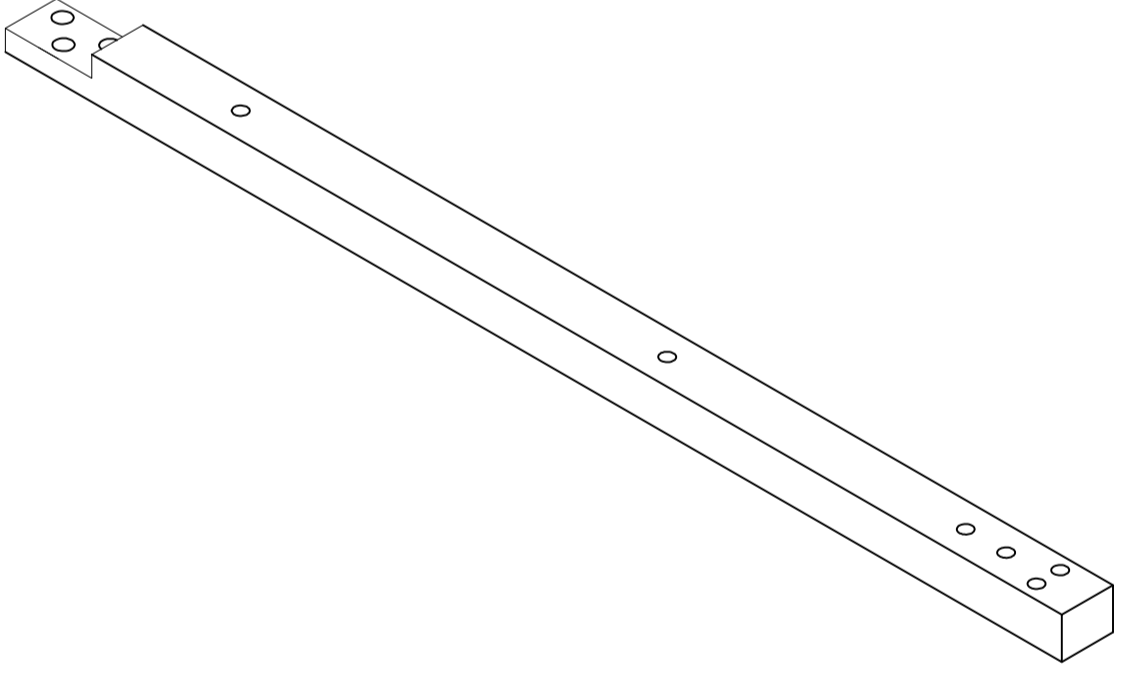
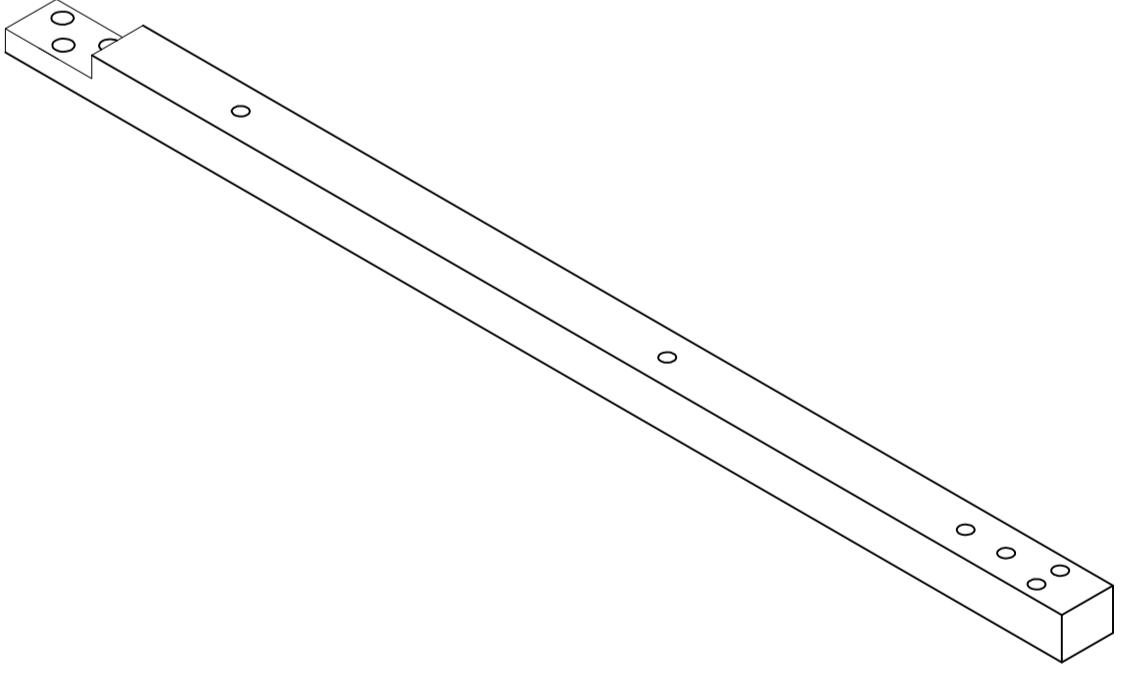
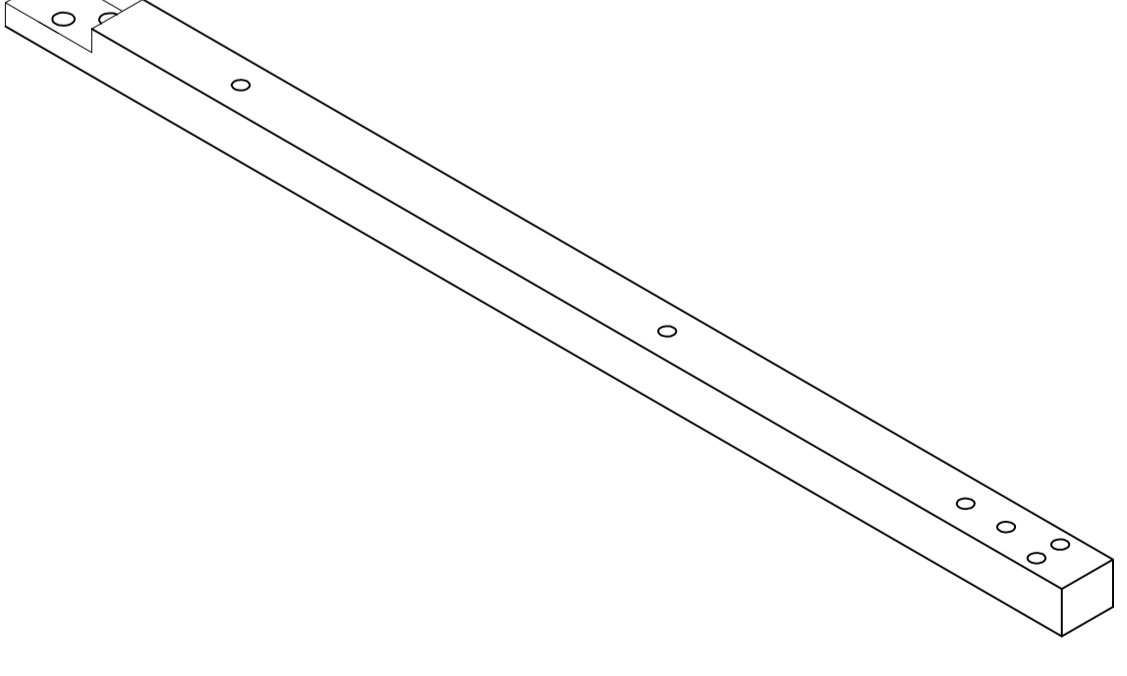
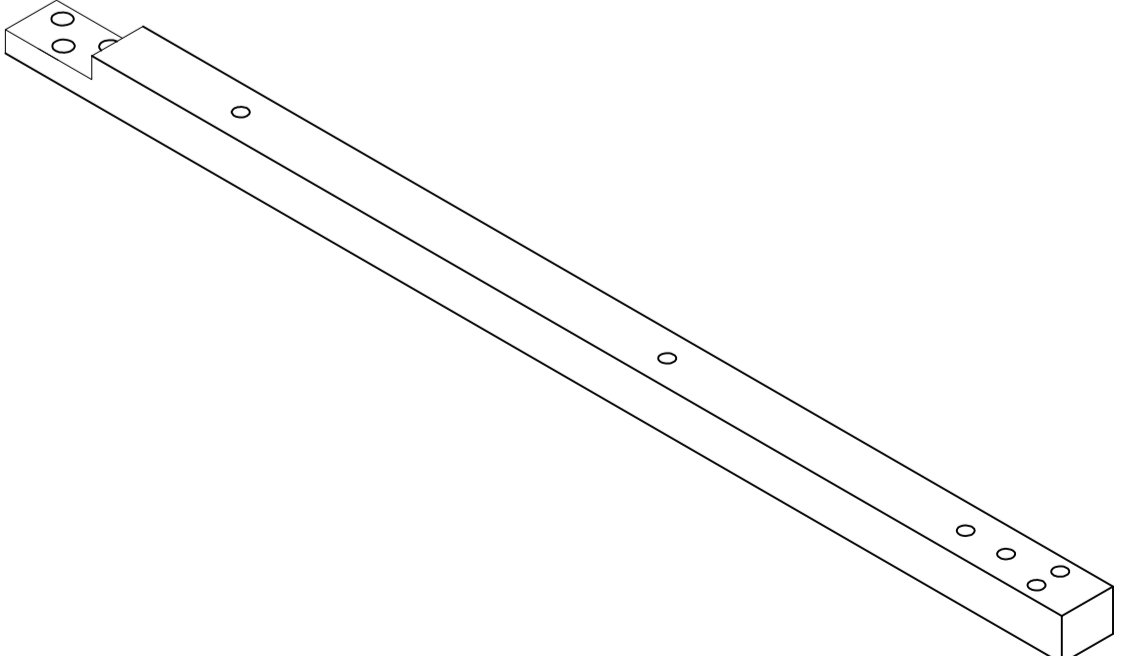
1		BARRE TRANSVERSALE CROSSBAR	1MC/PC
2		PATTE LEG	1MC/PC
3		PATTE LEG	1MC/PC
4		PATTE LEG	1MC/PC
5		PATTE LEG	1MC/PC
6		PATTE LEG	1MC/PC
7		PATTE LEG	1MC/PC
8		PATTE LEG	1MC/PC
9		PATTE LEG	1MC/PC

IDENTIFICATION DES PIÈCES
PARTS IDENTIFICATION

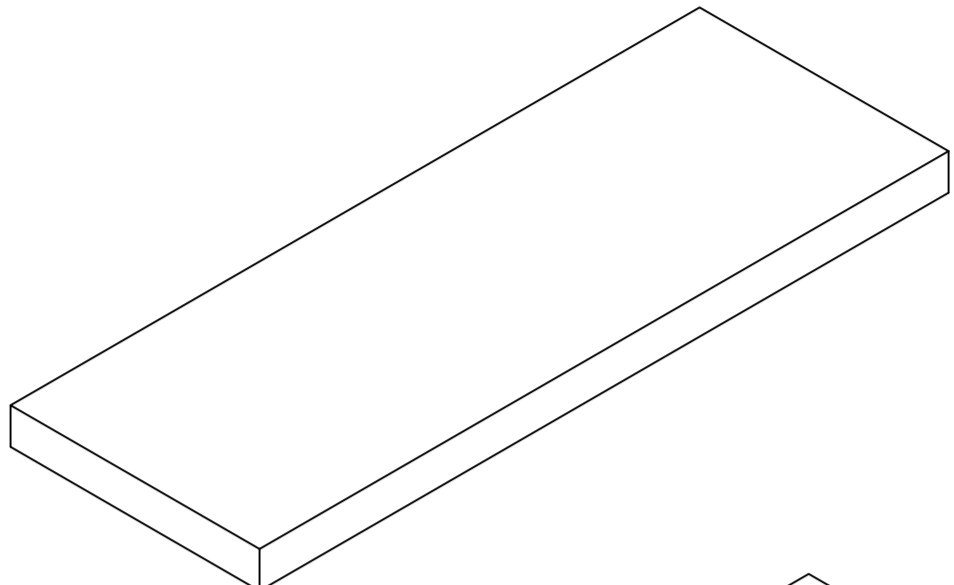
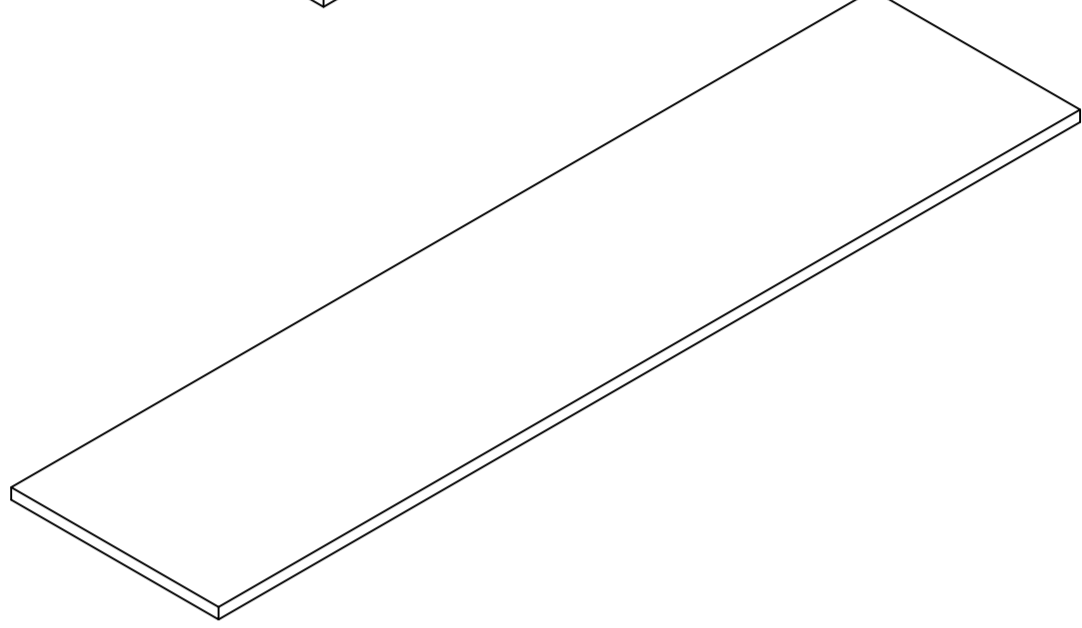
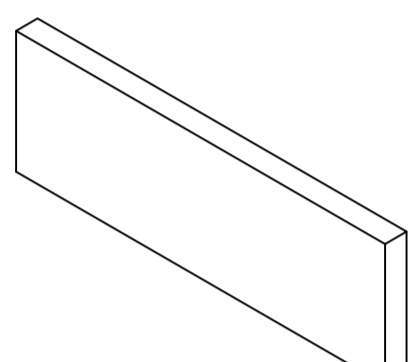
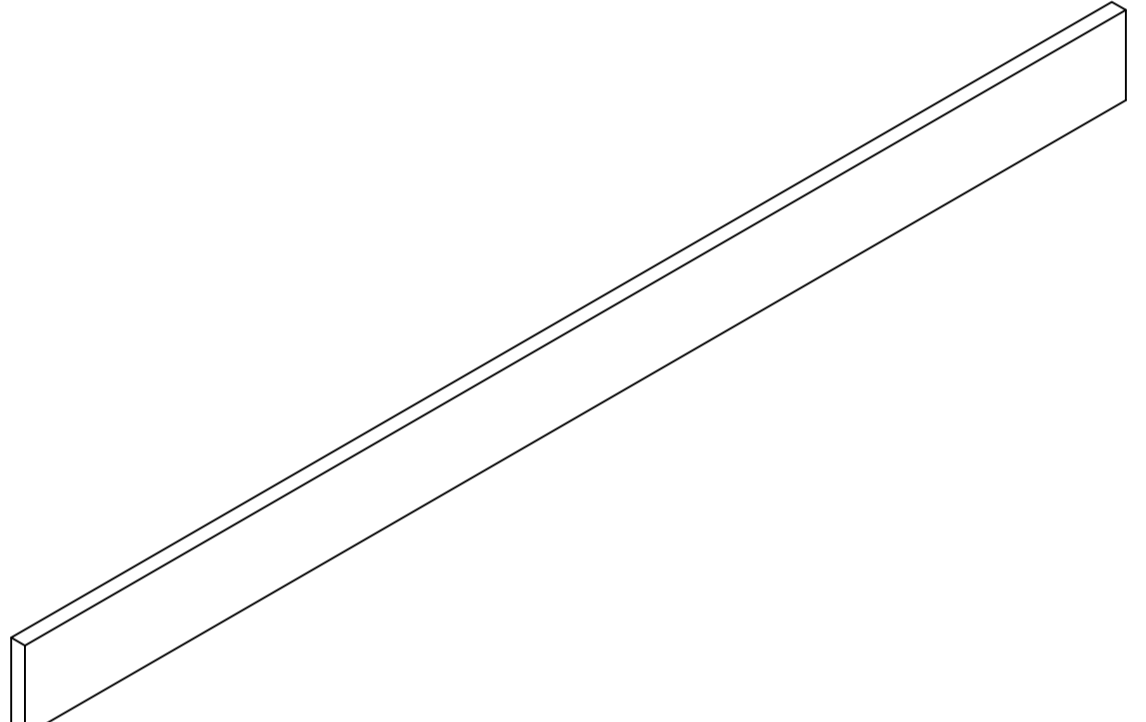
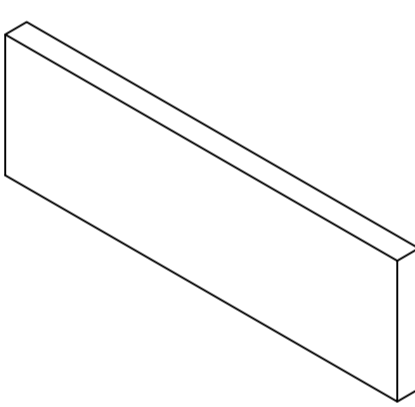
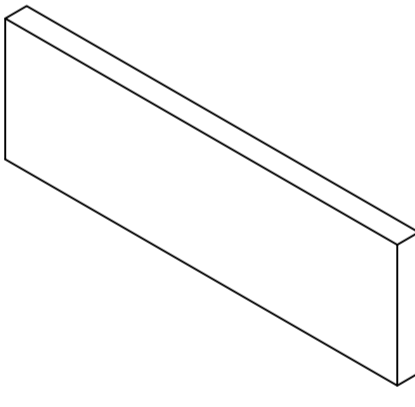
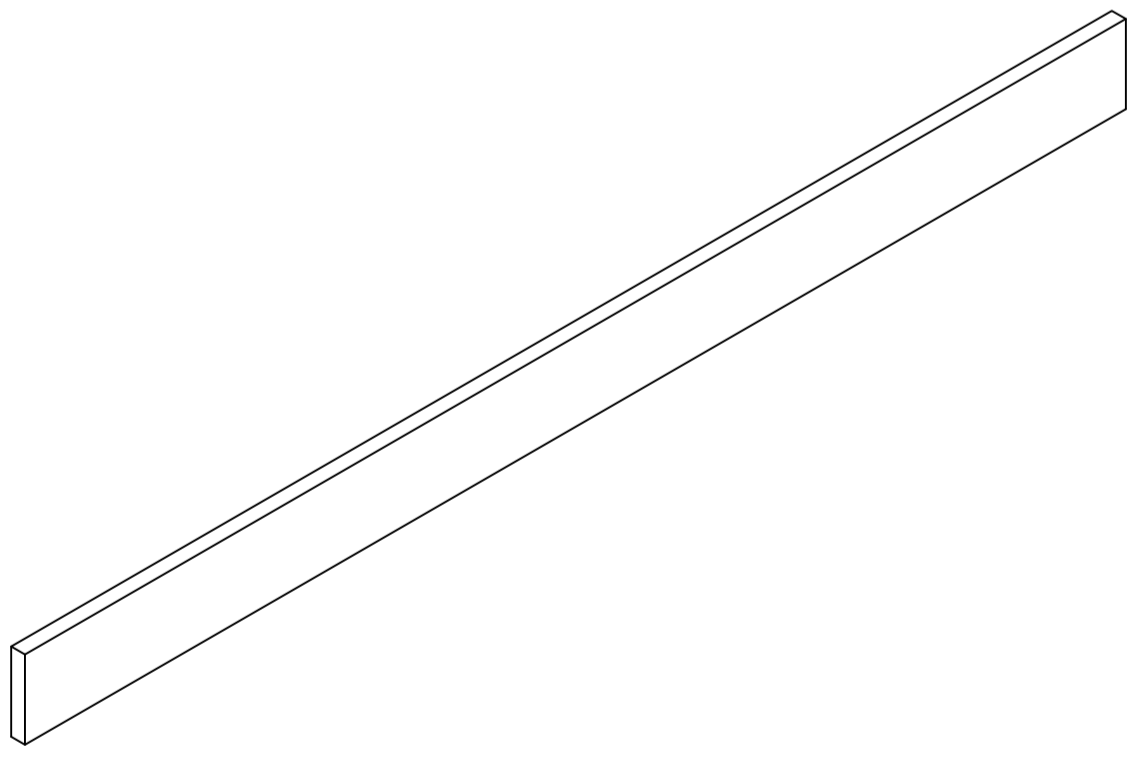
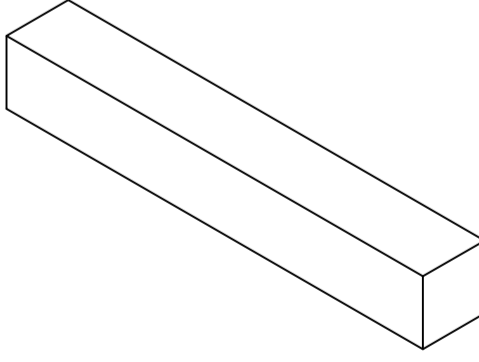
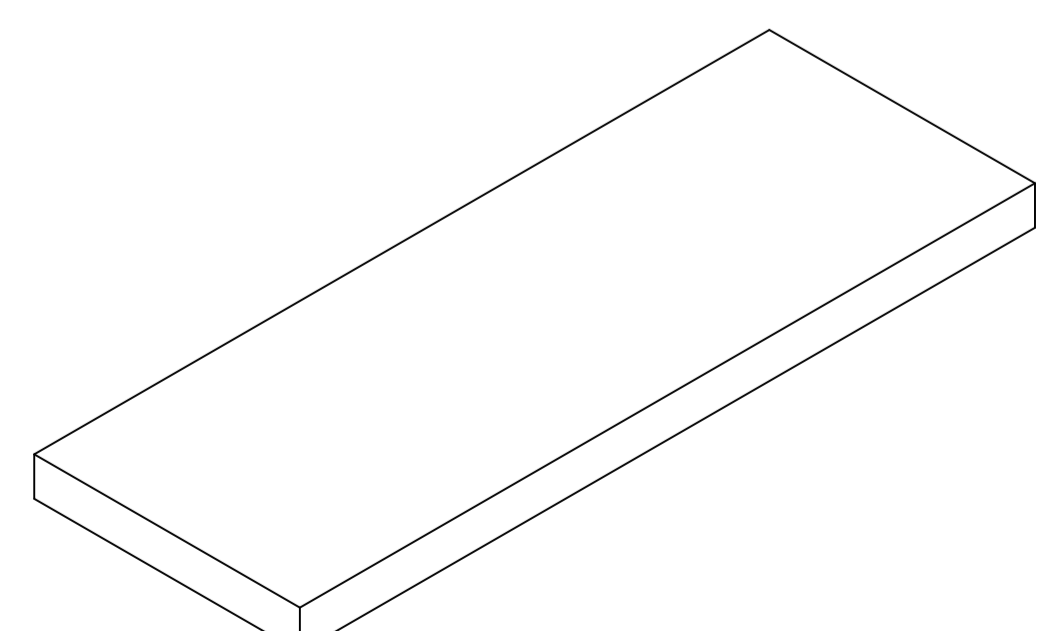
10		TABLETTE SHELF	2MCX/PCS
11		PANNEAU DU BAS BOTTOM PANEL	1MC/PC
12		BARRE DE SOUTIENT SUPPORT BAR	2MCX/PCS
13		BARRE DE SOUTIENT SUPPORT BAR	1MC/PC
14		BARRE DE SOUTIENT SUPPORT BAR	1MC/PC
15		BARRE DE SOUTIENT SUPPORT BAR	1MC/PC
16		BARRE DE SOUTIENT SUPPORT BAR	1MC/PC
17		BARRE TRANSVERSALE CROSSBAR	2MCX/PCS
18		TABLETTE SHELF	2MCX/PCS

IDENTIFICATION DES PIÈCES DE MONTAGE
HARDWARE IDENTIFICATION

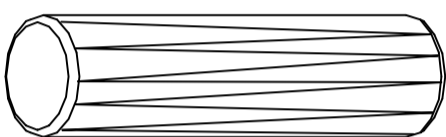
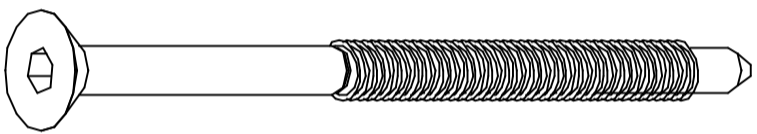
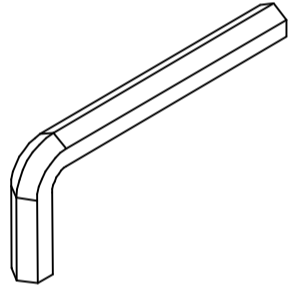
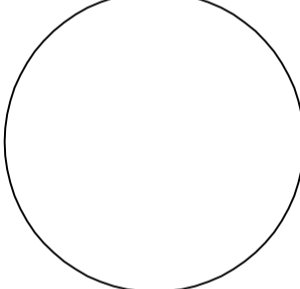
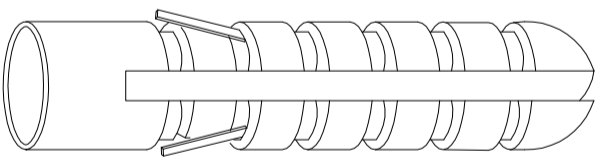
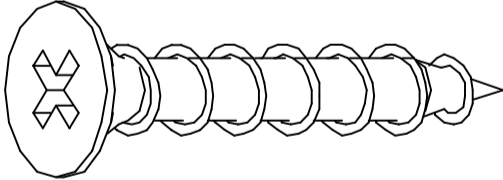
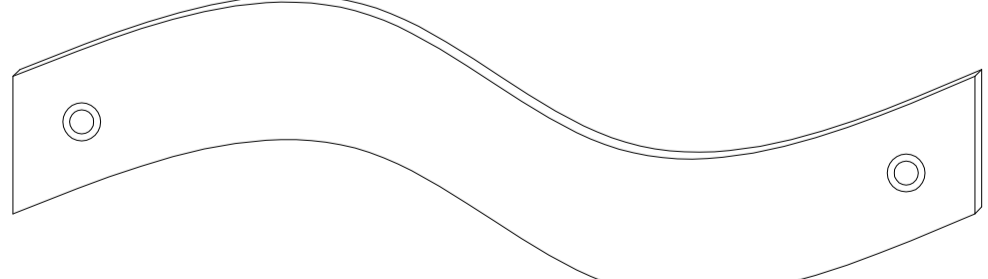
A		L=29mm	24MCX/PCS
B		Ø15mm	24MCX/PCS
C		Ø8x25mm	22MCX/PCS
D		Ø10x15mm	12MCX/PCS
E		Ø6x65mm	12MCX/PCS
F		M4mm	1MC/PC
G		Ø18mm	16MCX/PCS
H		Ø6x25mm	4MCX/PCS
I		Ø8x40mm	1MC/PC
J		Ø5x40mm	1MC/PC
K		Ø4x25mm	1MC/PC
L		200x12mm	1MC/PC

IDENTIFICATION DES PIÈCES DE MONTAGE
HARDWARE IDENTIFICATION

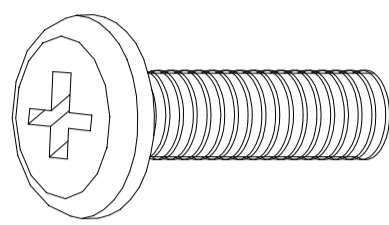
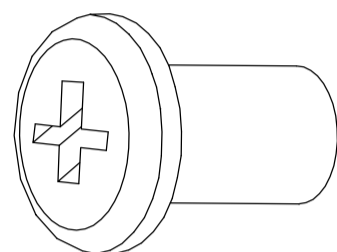
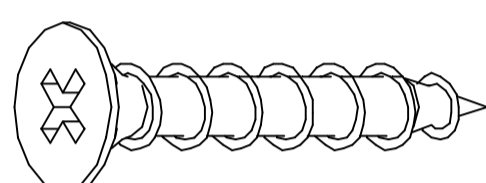
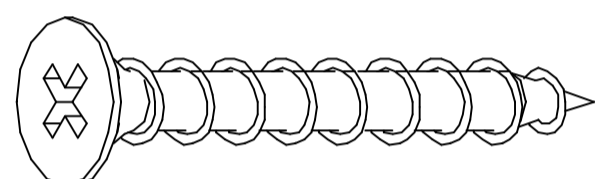
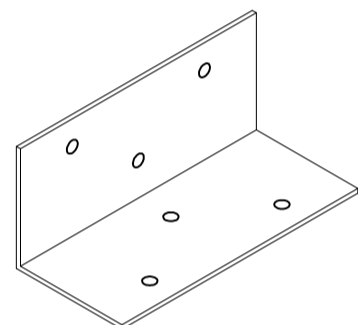
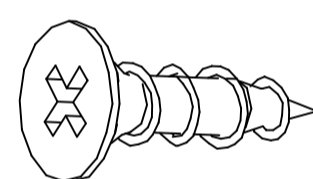
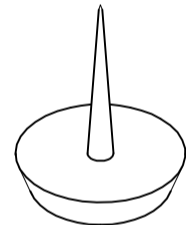
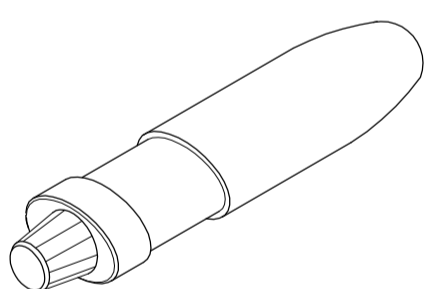
M		Ø6x45mm	18MCX/PCS
N		Ø10x11mm	18MCX/PCS
O		Ø4x35mm	4MCX/PCS
P		Ø4x45mm	2MCX/PCS
Q		50x35x35mm	2MCX/PCS
R		Ø4x16mm	12MCX/PCS
S		Ø16mm	8MCX/PCS
T		10g	1MC/PC

ÉTAPE / STEP 1

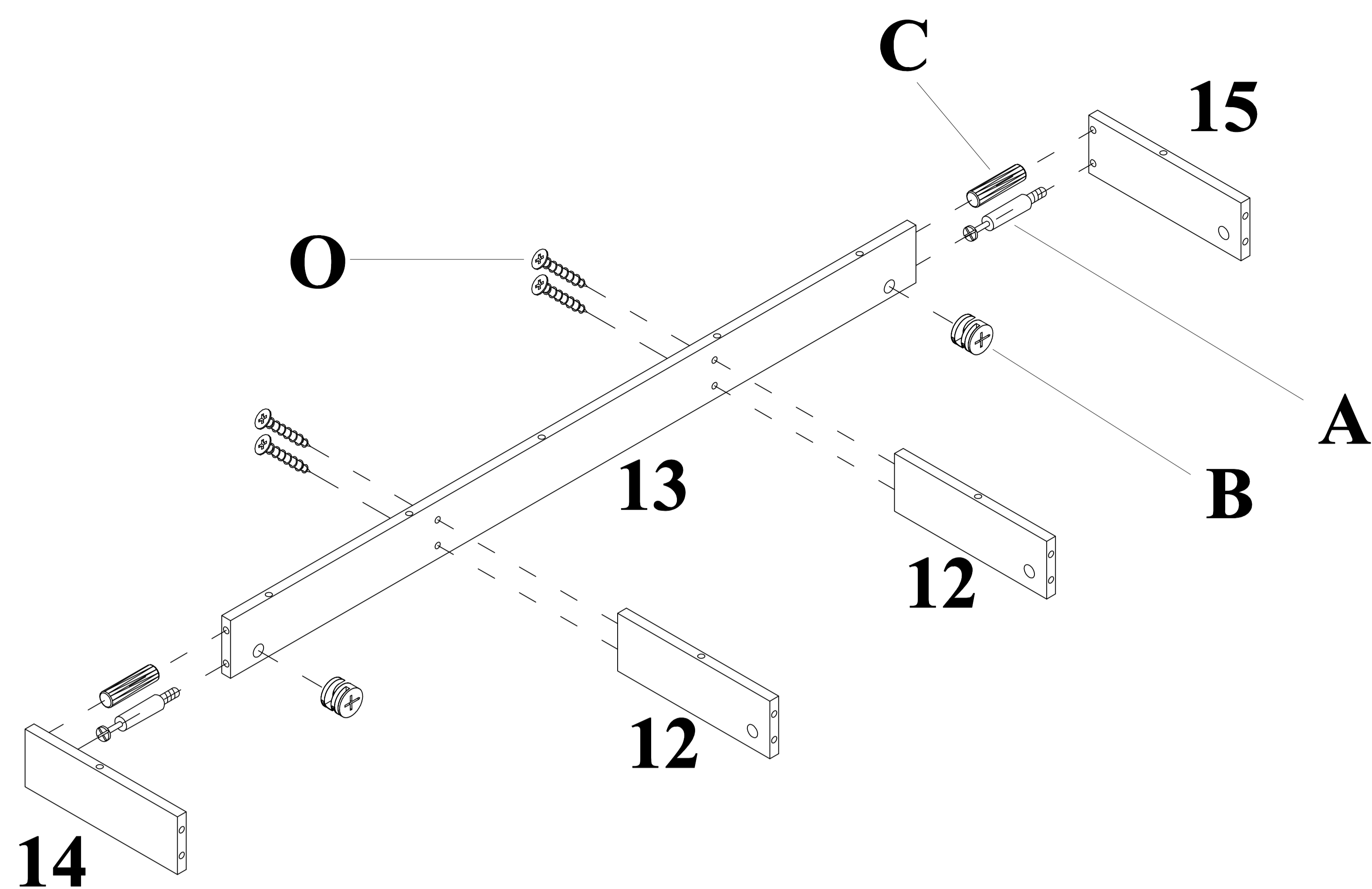

ÉTAPE / STEP 2

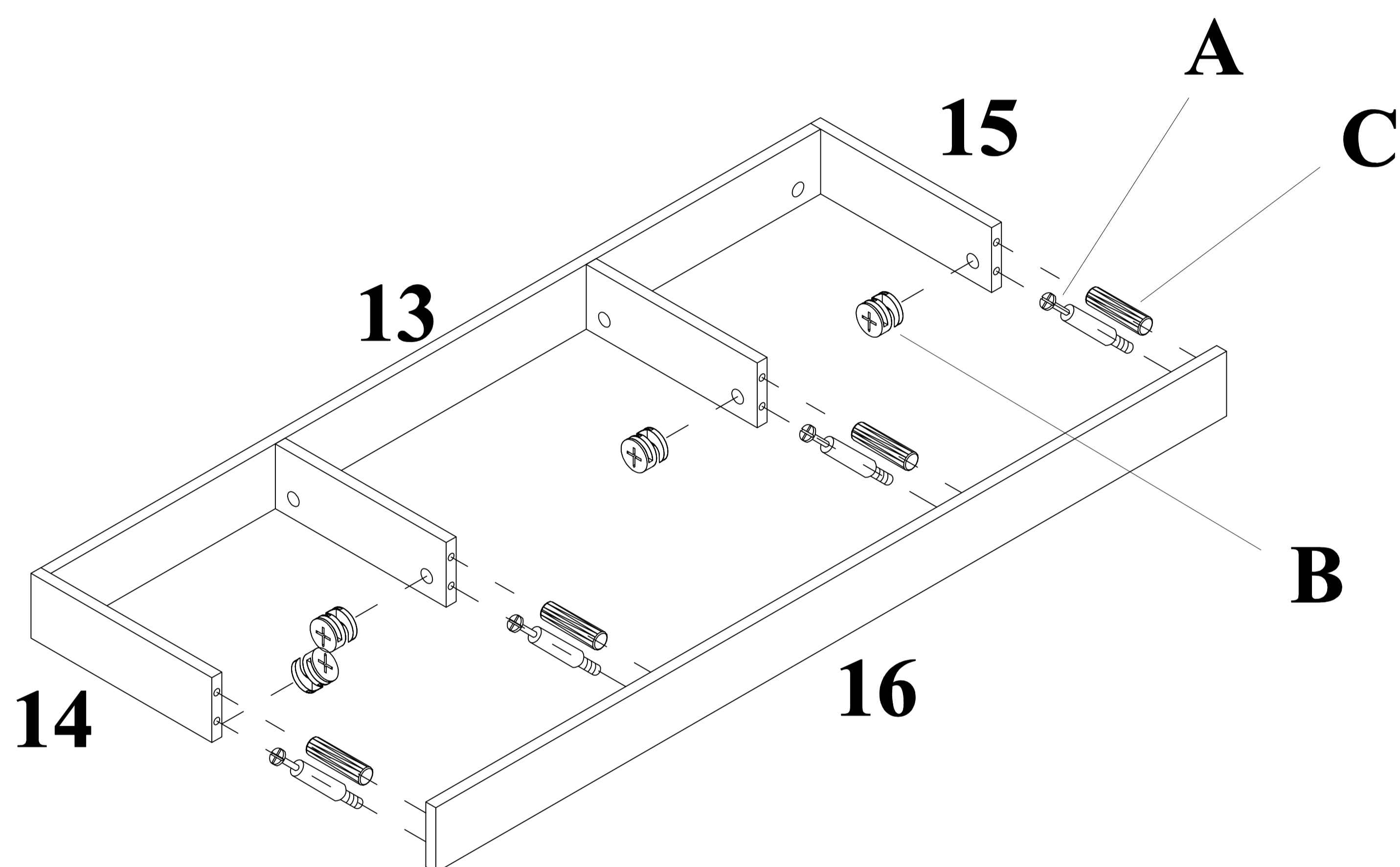

ÉTAPE / STEP 3

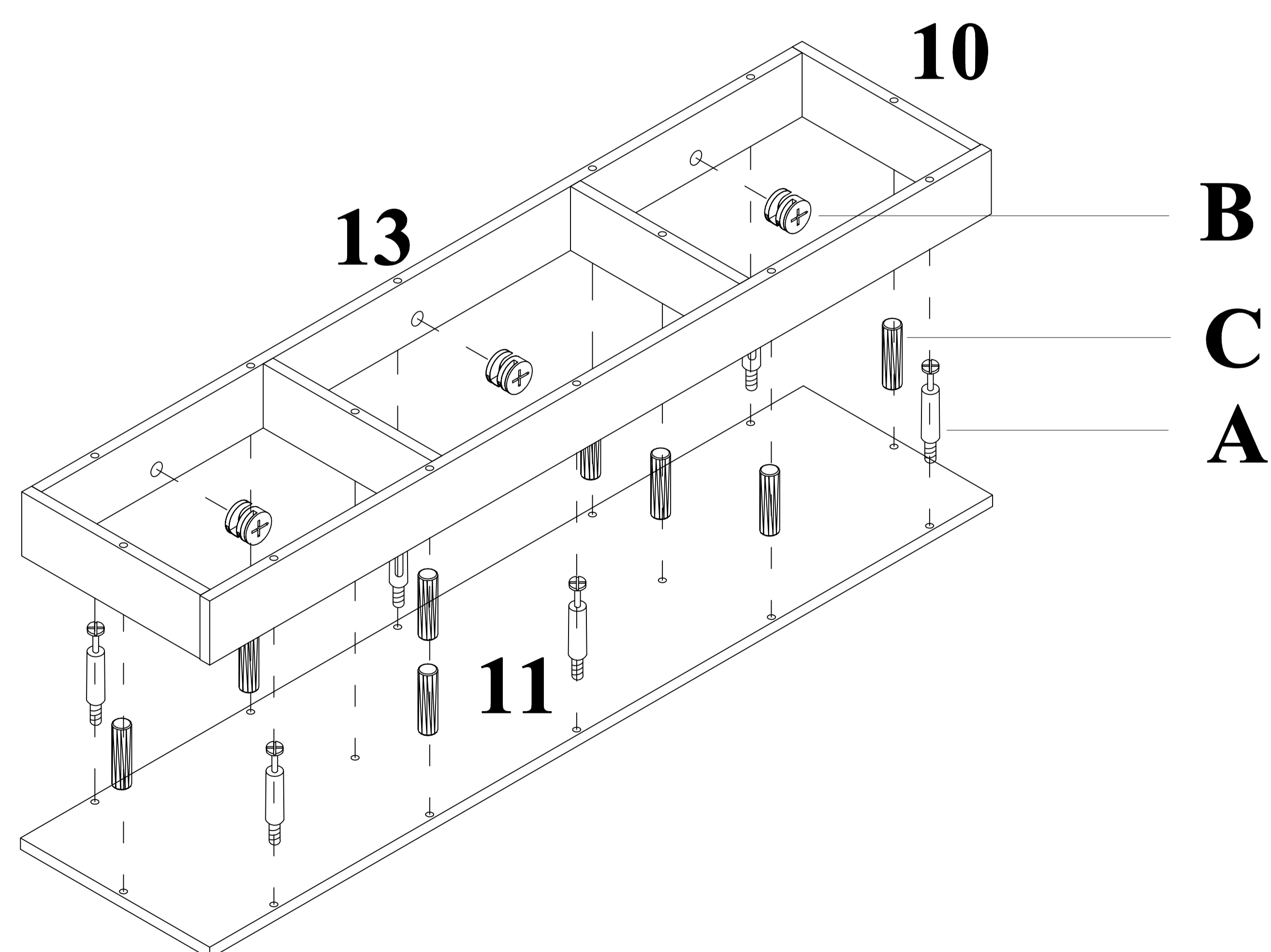

ÉTAPE / STEP 4

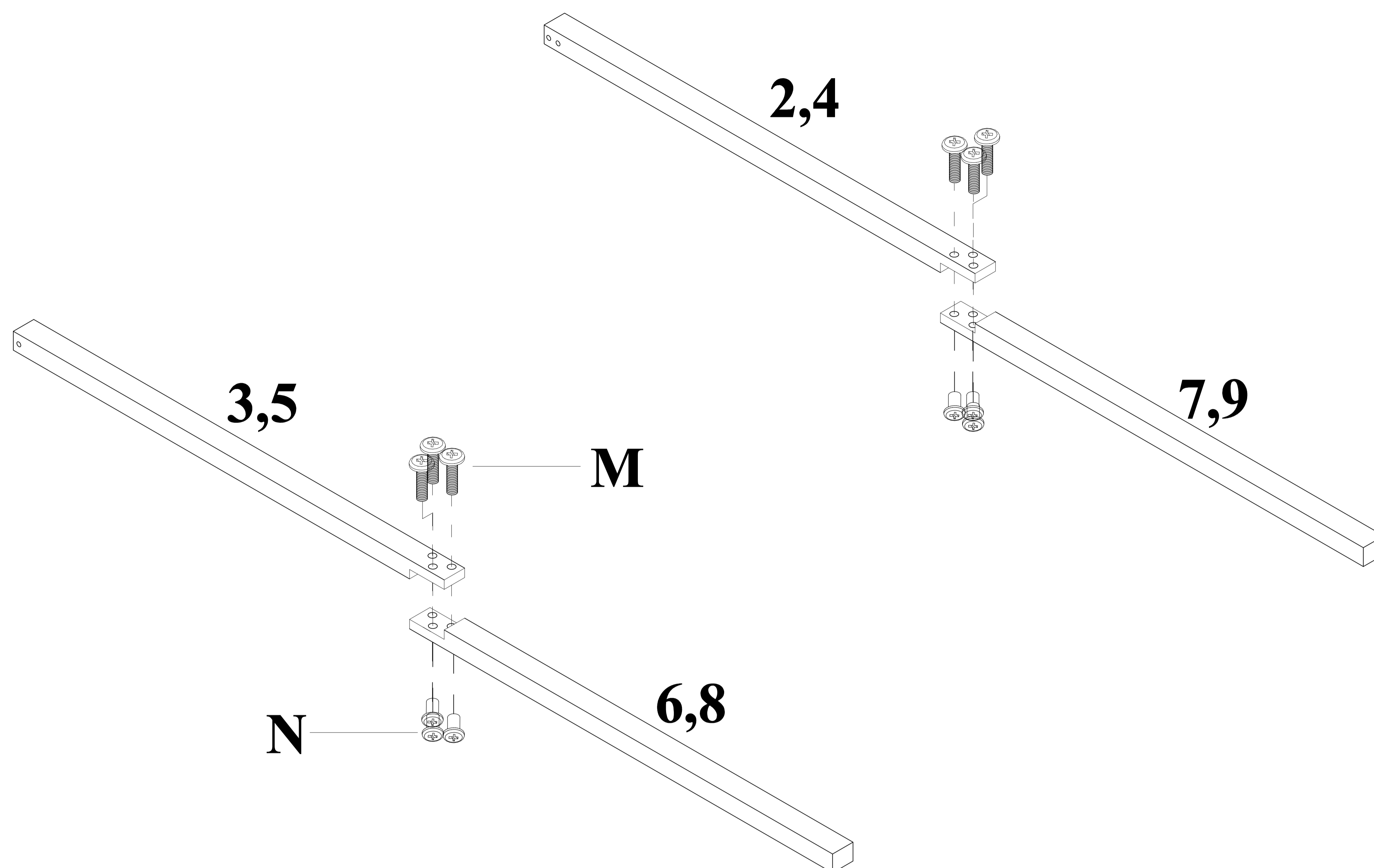

ÉTAPE / STEP 5

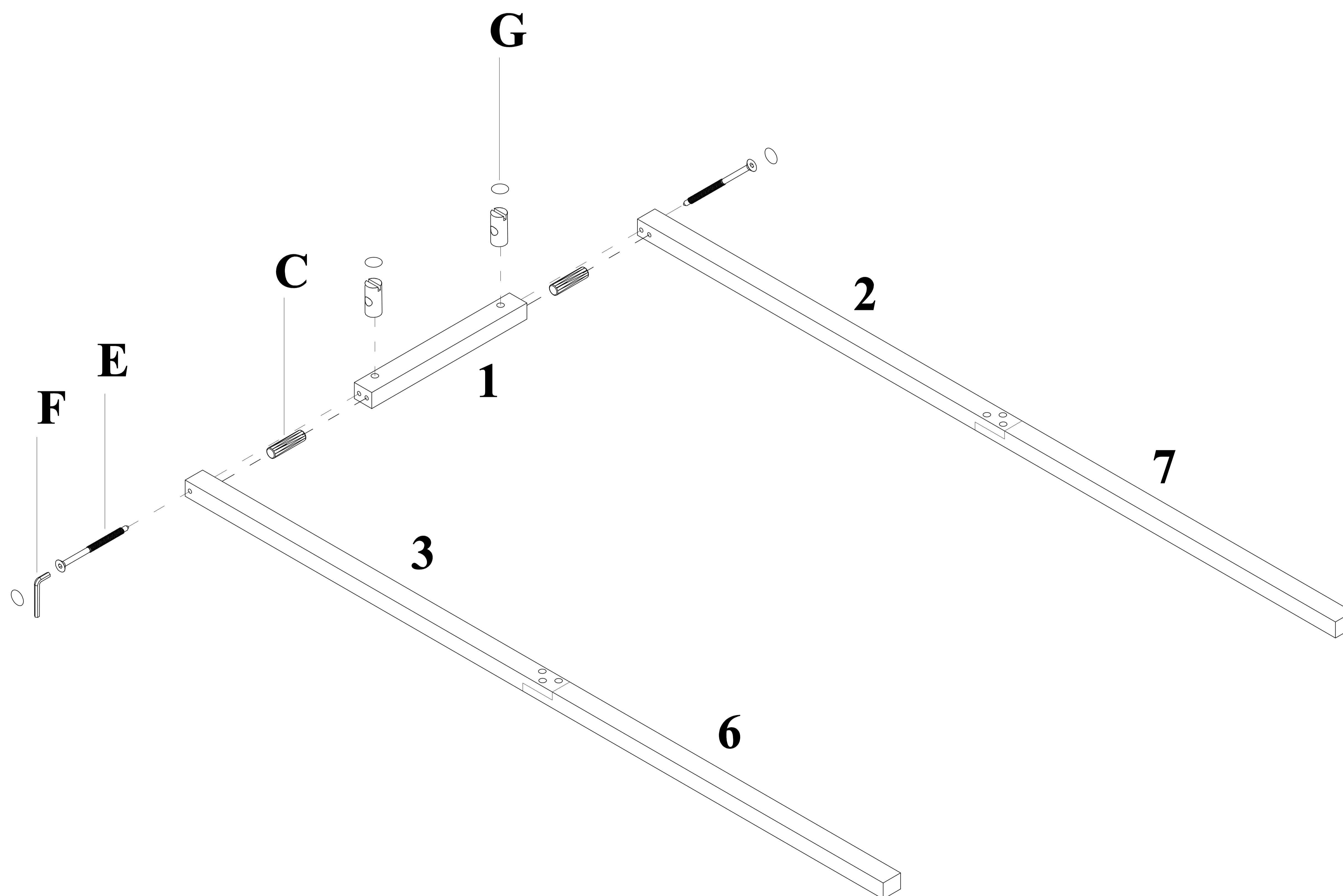

ÉTAPE / STEP 6

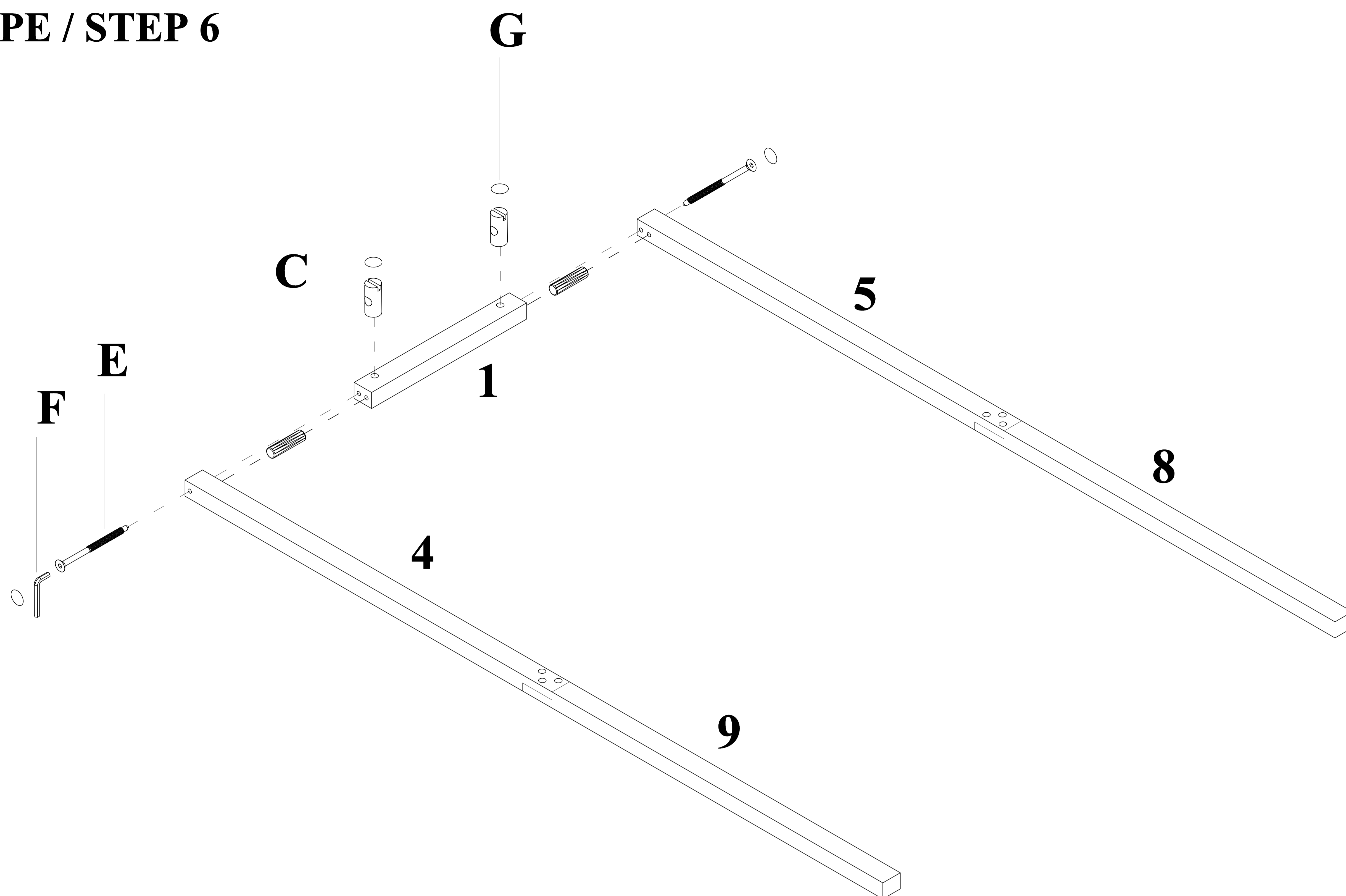

ÉTAPE / STEP 7

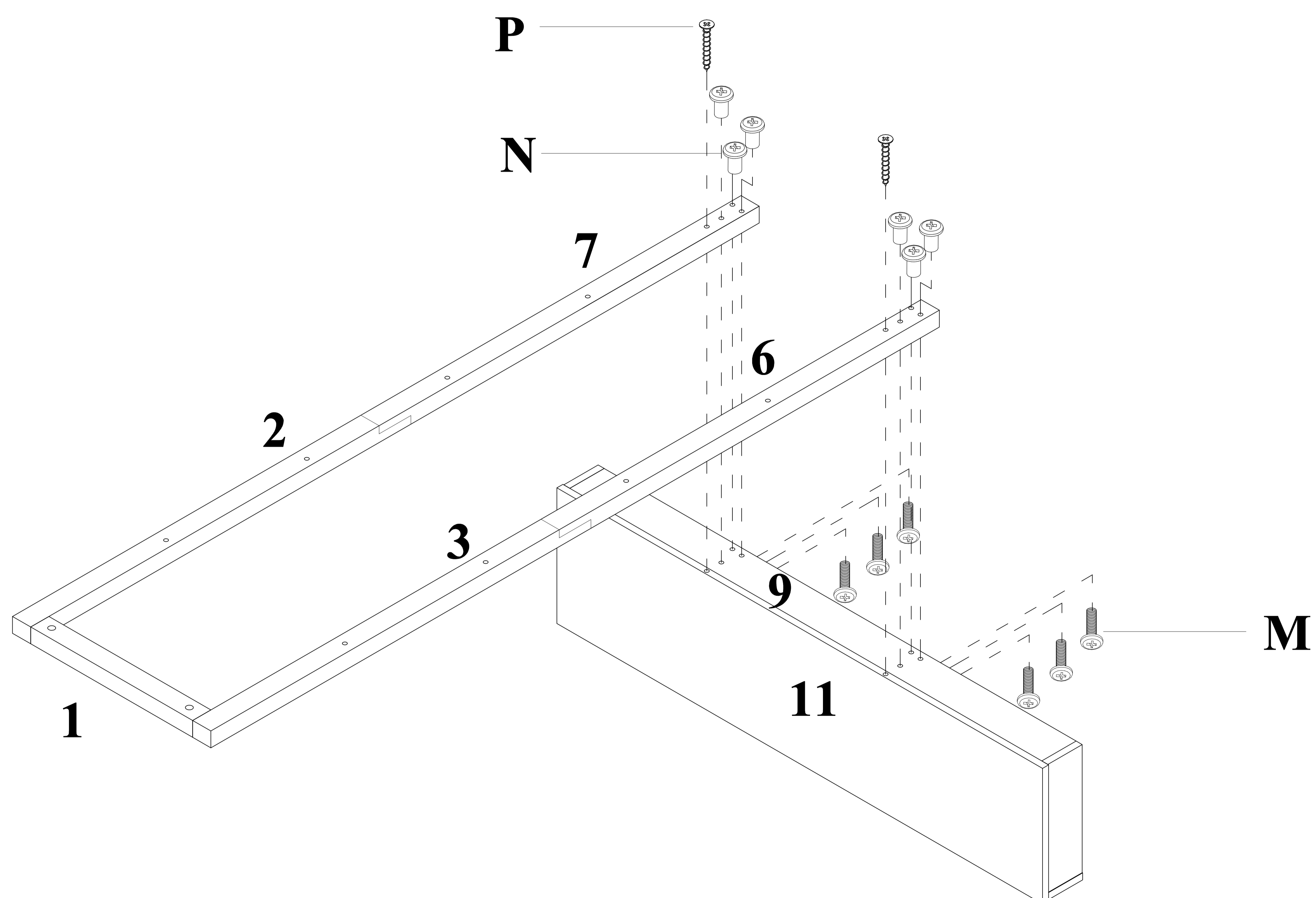

ÉTAPE / STEP 8

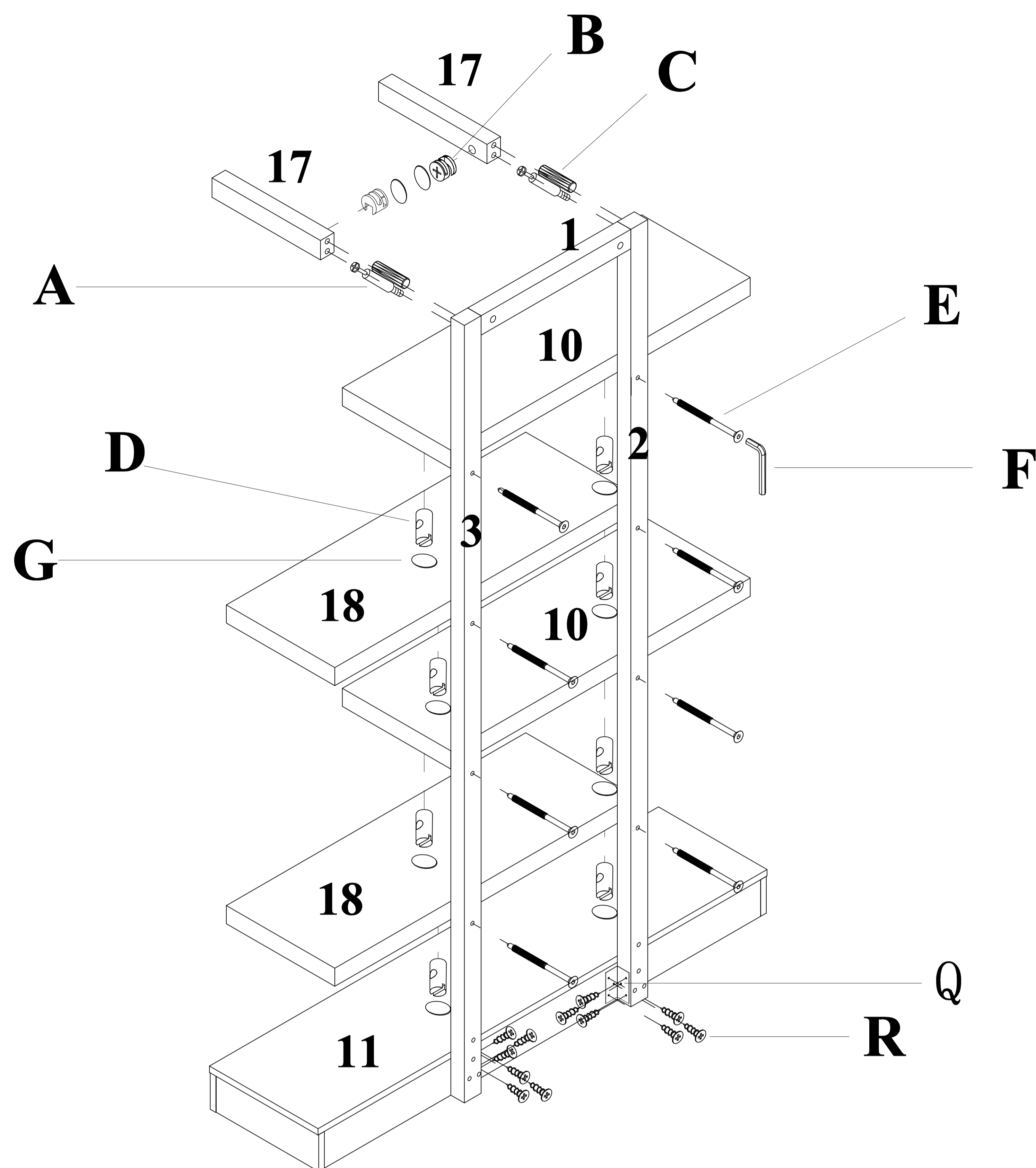

ÉTAPE / STEP 9

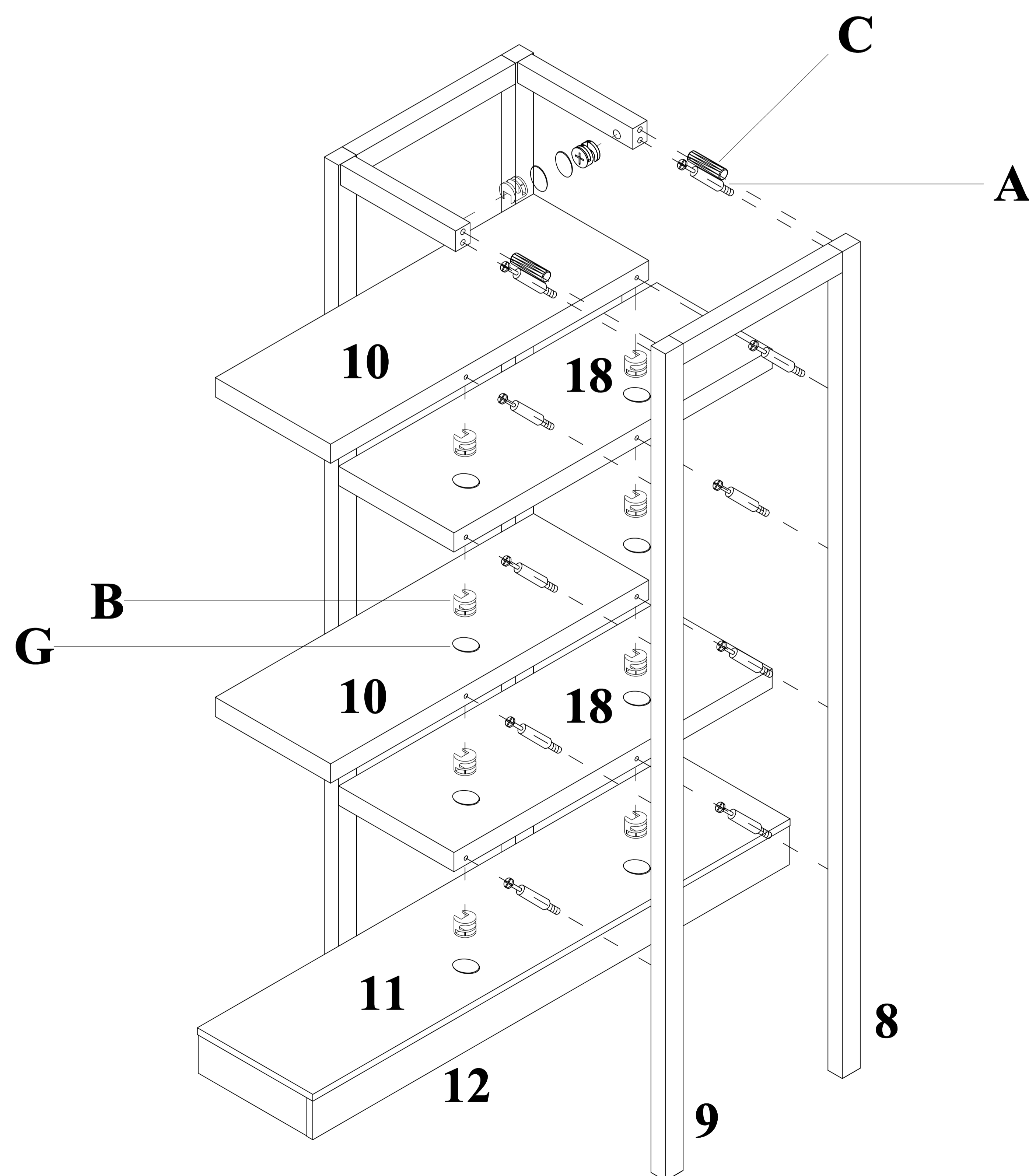

ÉTAPE / STEP 10

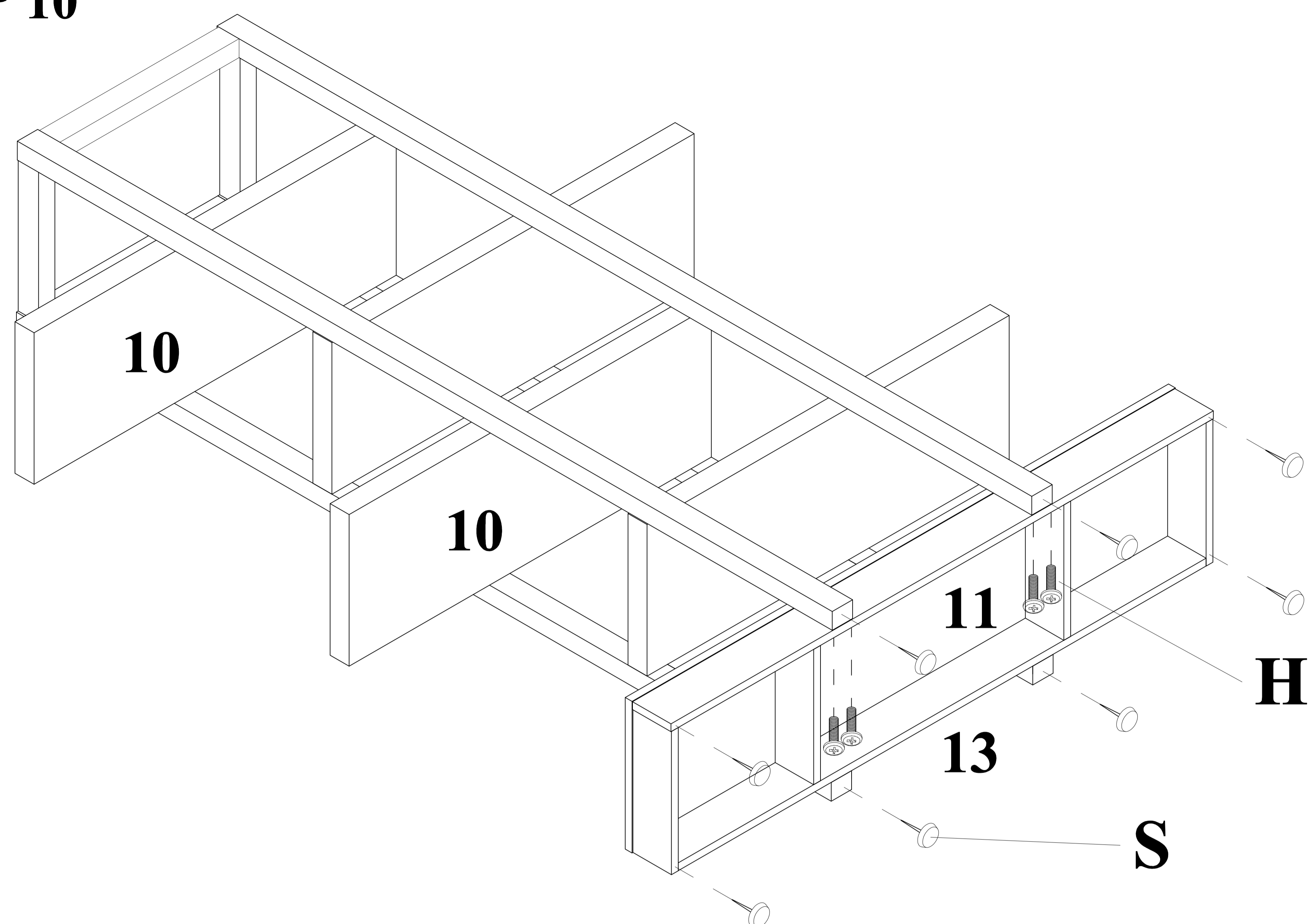

ÉTAPE / STEP 11

