

ASSEMBLY INSTRUCTIONS

INSTRUCTIONS DE MONTAGE • INSTRUCCIONES DE ENSAMBLAJE

TOOLS REQUIRED: Hammer, Allen Wrench (included)

PRODUCT WARRANTY REGISTRATION is available online at: www.safcoproducts.com

• **Outils Requis :** Le marteau,
Clef Allen (a inclus)

• **HERRAMIENTAS REQUERIDAS:** Martillo,
La llave hexagonal (incluido)





• L'INSCRIPTION POUR LA GARANTIE DU PRODUIT est
disponible sur l'Internet : www.safcoproducts.com

• EI REGISTRO PARA LA GARANTÍA DEL PRODUCTO está
disponible en la Internet: www.safcoproducts.com

PARTS LIST / LISTE DES PIÈCES / LISTA DE PIEZAS

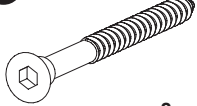
CODE / CODIGO	DESCRIPTION / DESCRIPTION / DESCRIPCIÓN	QTY. / QUANTITÉ / CANTIDAD	PART NO. / N° DE PIÈCE / NO. DE PIEZA
(A)	Side Panel / Panneau latéral / Panel del lado	2	3030-52PT
(B)	Top/Bottom Panel / Panneau Supérieur/Inférieur / Tablero Superior/del Fondo	2	3030-51PT
(C)	Back Panel / Panneau arrière / Tablero Trasero	1	3030-57NC
(D)	Edge Channel / Canal de bord / Canal de borde	2	3030-74PT
(E)	Partition / Partition / Partición	7	3030-53NC
(F)	Partition Channel / Canal de partition / Canal de partición	14	3030-75PT
(G)	Label Sheet Feuille de étiquettes / Hoja de Etiquetas	1	3030-85MP
(H)	Hardware Pack / Paquet matériel / Paquete material	1	3030-69NC

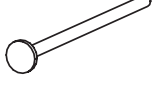
HARDWARE PACK / PAQUET MATÉRIEL / PAQUETE MATERIAL 3030-69NC

(I)	 Screw Vis Tornillo QTY: 8 #3030-58NC	(J)	 Screw Cover Couvercle pour les vis Tapa para los tornillos QTY: 8 #3030-72PT
(K)	 Allen Wrench Clef Allen Llave Allen QTY: 1 #3030-83NC	(L)	 Nail Clous puntas de Paris QTY: 20 #3030-66NC
(M)	 Rubber foot Pied en caoutchouc Pata de goma QTY: 4 #3030-81NC		

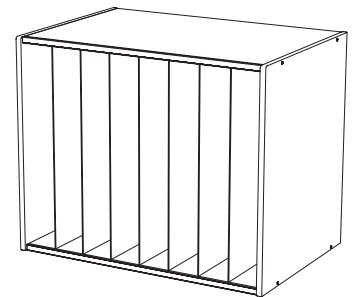
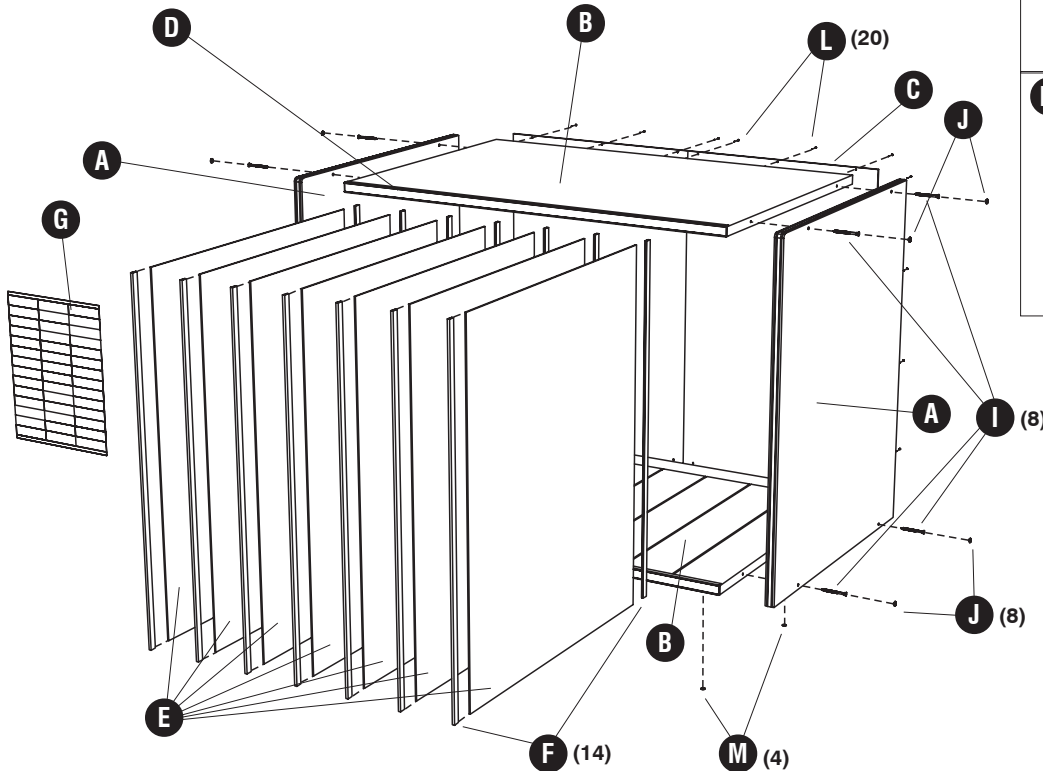

L'Assistance téléphonique à la clientèle Safco au 1-800-664-0042
de 8H00 à 16H30 (Heure centrale) (Opérateurs de langue anglaise)

Línea directa para el cliente de Safco 1-800-664-0042
de 8:00 AM a 4:30 PM (Hora Central) (Operadores que hablan inglés)

