

ASSEMBLY INSTRUCTIONS

INSTRUCTIONS DE MONTAGE

INSTRUCCIONES DE ENSAMBLAJE

4611 Bamboo Costumer

Arbre vêtements, en bambou

Árbol de la ropa, de bambú

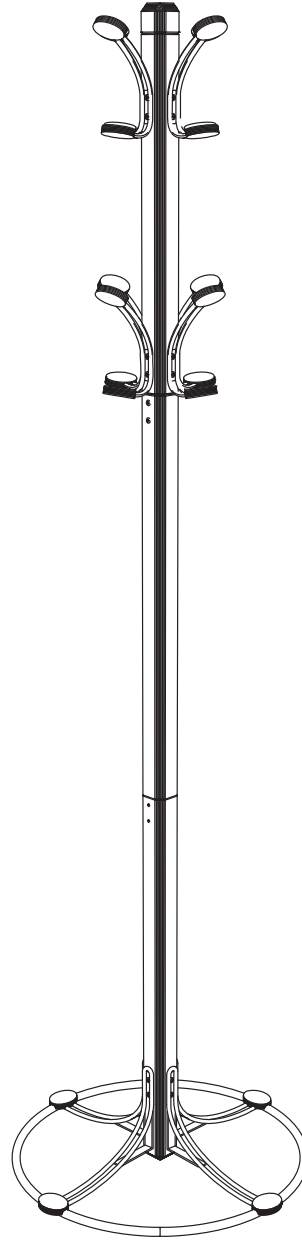

PRODUCT WARRANTY REGISTRATION is available online at: www.safcoproducts.com

• L'INSCRIPTION POUR LA GARANTIE DU PRODUIT est disponible sur l'Internet : www.safcoproducts.com

• EI REGISTRO PARA LA GARANTÍA DEL PRODUCTO está disponible en la Internet: www.safcoproducts.com





For questions or concerns, please call **1-800-664-0042**
available Monday-Friday 7:00 AM to 6:00 PM (Central Time) (English-speaking operators)

Si vous avez des questions pour poser ou les préoccupations
pour exprimer, connecter **au 1-800-664-0042**
de 7H00 à 18H00 (Heure centrale) (Opérateurs de langue anglaise)

Si usted tiene preguntas o preocupaciones,
por favor llame **1-800-664-0042**
de 7:00 AM a 6:00 PM (Hora Central) (Operadores que hablan inglés)

PARTS LIST			
CODE	DESCRIPTION	QTY.	PART NO.
(A)	Upper Post	1	4611-01§
(B)	Center Post	1	4611-02§
(C)	Bottom Post	1	4611-03§
(D)	Ring Half	1	4611-04SL
(E)	Hook	8	4611-06§
(F)	Wire Leg	4	461107SL





§Note: When corresponding about parts, be sure to state color: Cherry (CY), Natural(NA).

HARDWARE PACK 4611-19NC		
G  Hex Nut Qty. 8 #4611-21NC	H  Hook/ Leg Screw Qty. 24 #4611-22NC	I  Post Screw Qty. 8 #4611-23NC
J  Foot Screw Qty. 4 #4611-24NC	K  Ring Screw Qty. 2 #4611-25NC	

HARDWARE PACK 4611-99§	
L  Foot Qty. 4 #4611-08§	

LISTE DES PIÈCES			
CODE	DESCRIPTION	QUANTITÉ/	N° DE PIÈCE / NO.
(A)	Haut Poteau	1	4611-01§
(B)	Centre Poteau	1	4611-02§
(C)	Inférieur Poteau	1	4611-03§
(D)	Demi anneau	1	4611-04SL
(E)	Crochet	8	4611-06§
(F)	Pied Barre	4	461107SL

§ Note: Quand correspondre au sujet de parties,soyez sûr d'affirmer la couleur: Cerise(CY), Naturel(NA).

PAQUET MATÉRIEL 4611-19NC		
G  Hexagonale Écrou Qty. 8 #4611-21NC	H  Crochet / Pied Vis Qty. 24 #4611-22NC	I  Vis pour la Poteau Qty. 8 #4611-23NC
J  Pied Vis Qty. 4 #4611-24NC	K  Anneau Vis Qty. 2 #4611-25NC	

PAQUET MATERIEL 4611-99§	
L  Pied Qty. 4 #4611-08§	

LISTA DE PIEZAS			
Código	DESCRIPCIÓN	CANTIDAD	NO. DE PIEZA
(A)	Poste Superior	1	4611-01§
(B)	Poste Centre	1	4611-02§
(C)	Poste Inferior	1	4611-03§
(D)	La mitad del anillo	1	4611-04SL
(E)	Gancho	8	4611-06§
(F)	Barra para los Pies	4	461107SL

§ Note: Al corresponder sobre las piezas,esté seguro declarar el color: Cereza (CY),Natural(NA).

PAQUETE MATERIAL 4611-19NC		
G  Tuerca hexagonal Qty. 8 #4611-21NC	H  Tornillo para el gancho o la pierna Qty. 24 #4611-22NC	I  Tornillos para el Poste Qty. 8 #4611-23NC
J  Tornillo pie Qty. 4 #4611-24NC	K  Tornillos para el anillo Qty. 2 #4611-25NC	

PAQUETE MATERIAL 4611-99§	
L  Pie Qty. 4 #4611-08§	

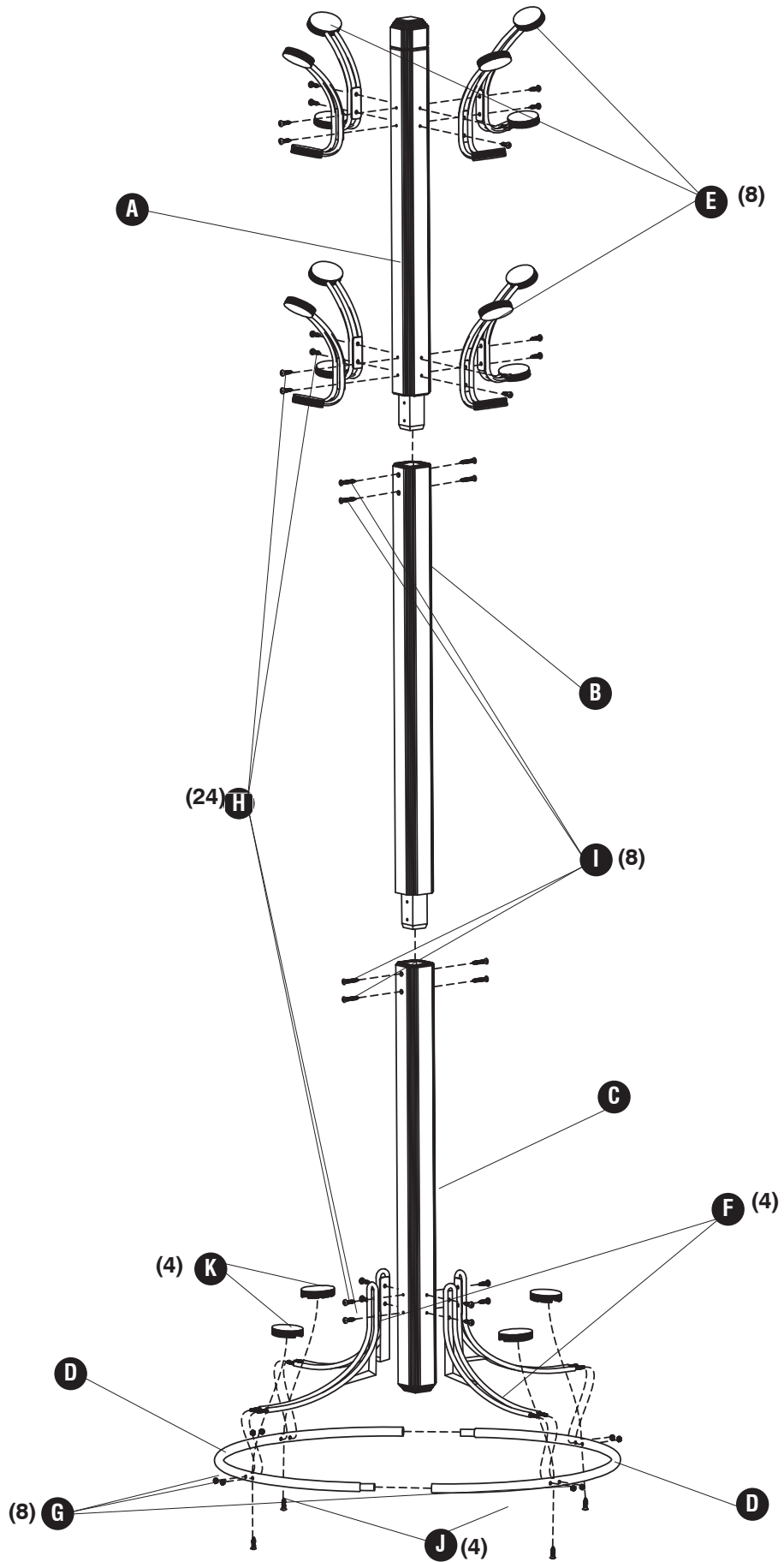

1 **K**  (2)

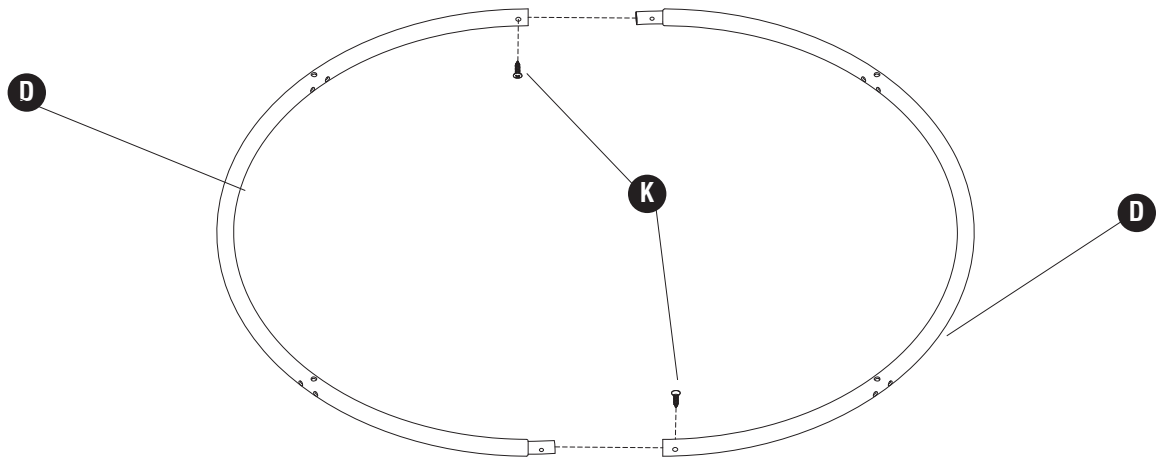

2

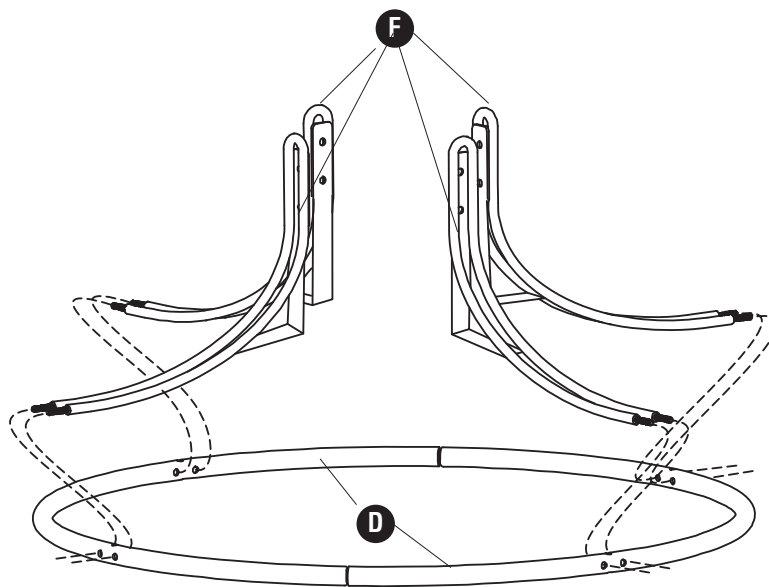

3 **H** (8)

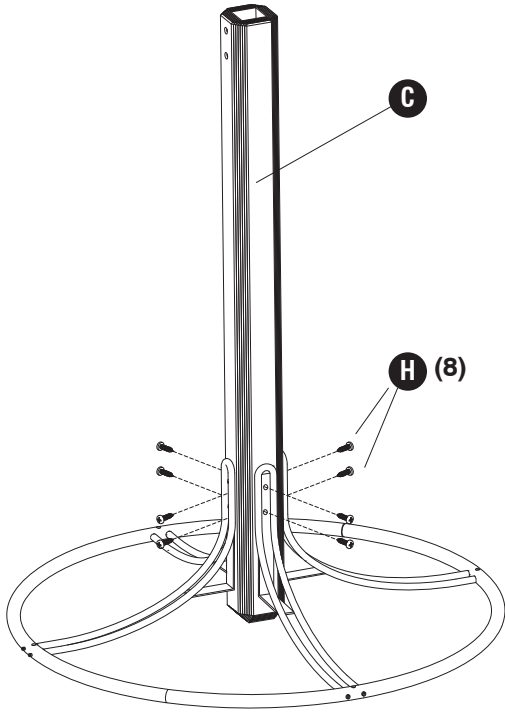

4 **G** (8)

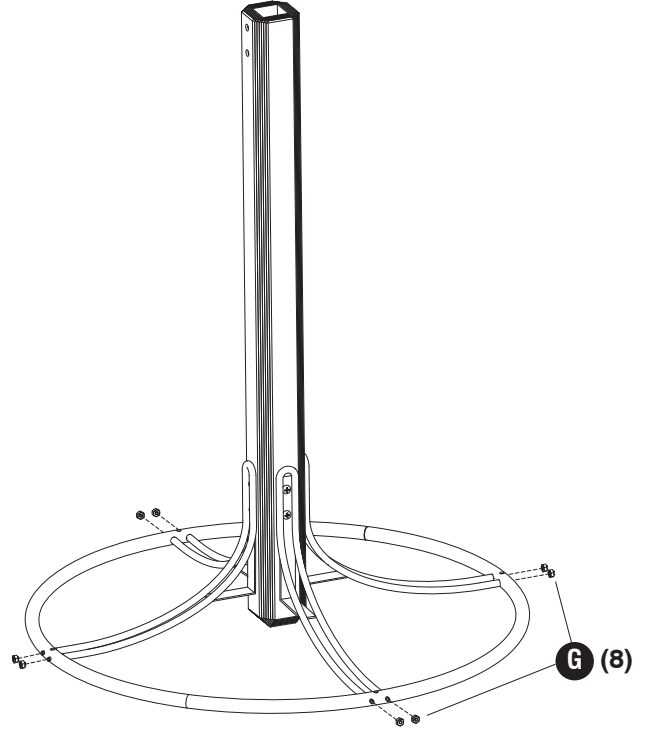

5 **J** (4) **L** (4)

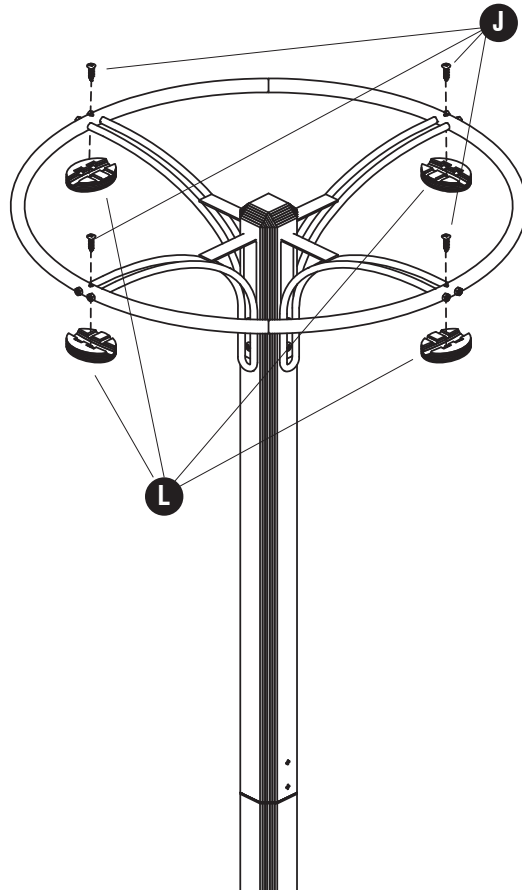

6 **I**  **(8)**

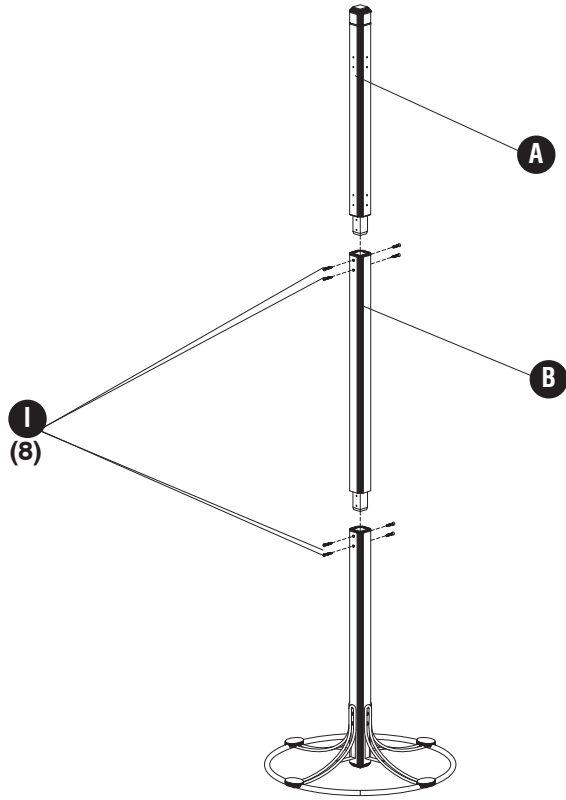

7 **H**  **(16)**

