

Thank You!

Thank you for choosing Way Basics! With your help, Way Basics products are helping protect the environment. No new trees were cut down to create our furniture, because it's made from recycled paper. At the end of its long life we hope you'll find other uses for our zBoards or simply recycle – then they might eventually find their way back to Way Basics where we'll make them into new zBoards!

What's Included

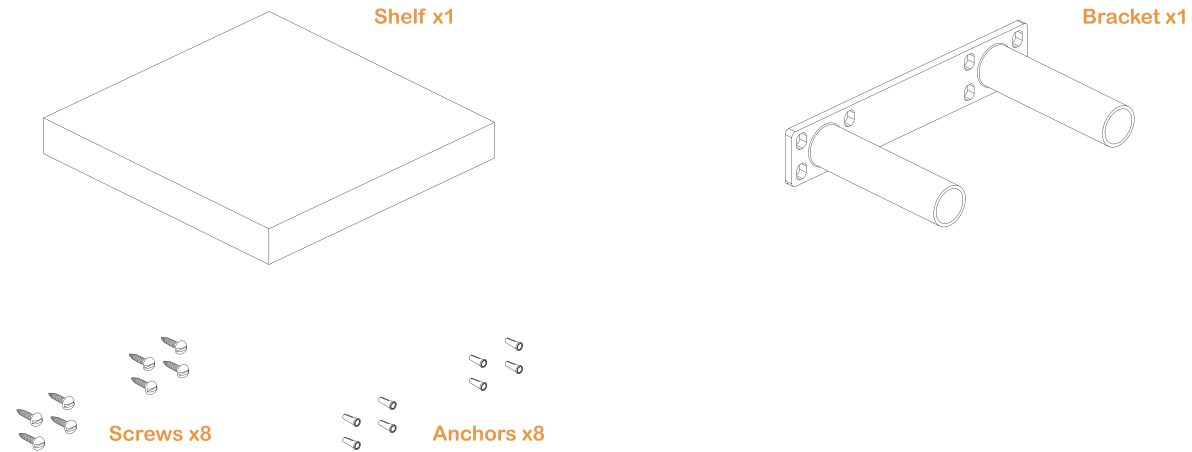

Turn this page over to get started!

Tools Needed



Connect
With Us



talktous@waybasics.com



Share Your Photos and Win
www.waybasics.com/share

Easy Assembly

1 Place bracket on wall

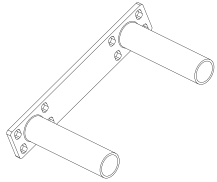

2 Level bracket

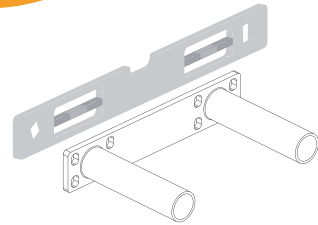

3 Mark 8 holes onto wall with pencil

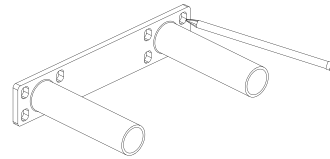

4 Drill 8 holes into wall with 1/4 bit

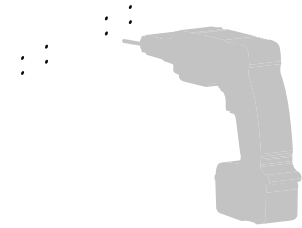

5 Insert anchors into holes

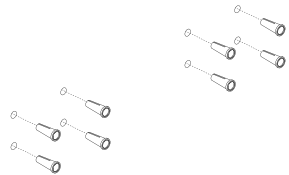

6 Fasten bracket to wall anchors with screws

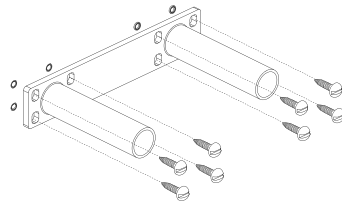

7 Insert shelf onto bracket

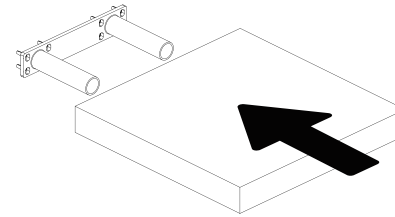

8 That was easy, wasn't it?

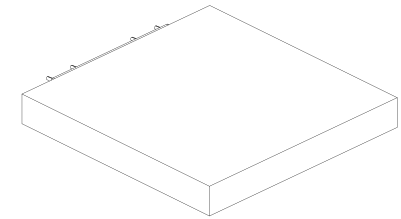

Get Creative!

