

saxby  
lighting



**POLGUI0**

Opaz Spike Light

Thank you for purchasing this light fitting.

Please read the instructions carefully before use to ensure safe and satisfactory operation of this product.

Please retain these instructions for future reference.

## Warning

**This is a Class I product and must be earthed.**

Please read these instructions carefully before commencing any work.

This unit must be fitted by a competent and qualified electrician.

Install in accordance with IEE Wiring regulations and current Building Regulations.

To prevent electrocution switch off at mains supply before installing or maintaining this fitting. Ensure other persons cannot restore the electrical supply without your knowledge. If you are in any doubt, please consult a qualified electrician.

This light fitting should be connected to a fused circuit.

If replacing an existing fitting, make a careful note of the connections.

Always use the correct type and wattage bulb. Never exceed the wattage stated.

When changing a bulb, always switch off at the mains and allow the old bulb to cool down before handling.

Dispose of used bulbs carefully and responsibly.

Waste electrical products should not be disposed of with household waste. Please recycle where facilities exist.

Check with your local authority or retailer for recycling advice.

This product is rated at IP54.

This product is not suitable for location in or near a marine environment.

The entire unit gets hot whilst on for a period of time.

If the external flexible cable or cord of this lamp is damaged the lamp must be returned to the service agent for repair.

## Specification

Voltage:	240V 50Hz a.c.
Lamp:	50W GU10 Halogen
IP rating:	44

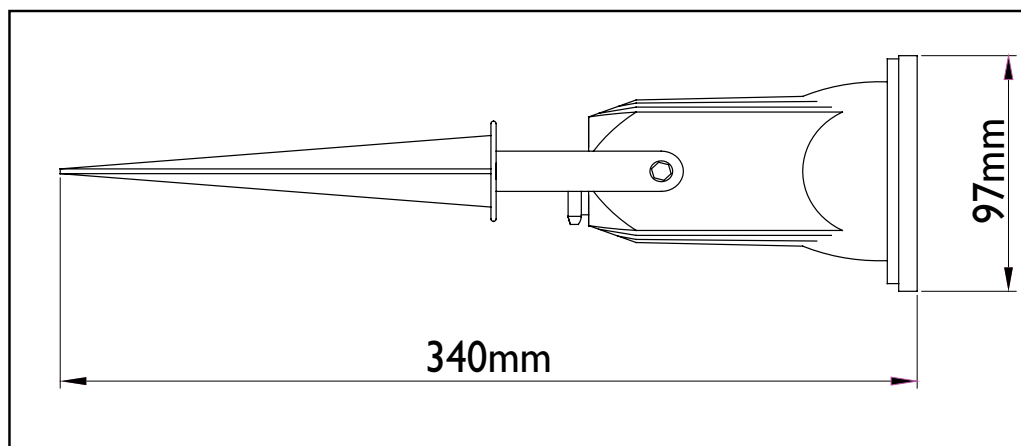

## Layout

- Decide on the position of the luminaire. Depending on the location, an approved outdoor rated plug and socket may be required. Alternatively an approved outdoor rated external terminal block may be used.
- Avoid locating any cables in positions that would cause a hazard. Position cables and connector block away from areas where they may be at risk from being cut, trapped or damaged.
- Cables that are to be in walls and concealed underground must be protected using suitable conduit or plastic trunking.
- Ensure that the ground is suitable for pushing the spike into, and can support the luminaire. Do not install in very wet or boggy areas.

## Installation

Existing fittings must be completely removed before installation of a new product. Before removing the existing fitting, **carefully note the position of each set of wires.**

# Wiring

## Plug Fitting

1. The appliance must be connected to a 240 volts AC supply.
2. The appliance can be fitted to a rewireable 3 pin plug fitted with a 3 amp fuse. Should the fuse require replacement, it must be replaced with a fuse rated at 3 amp and approved to BS1362.
3. If the mains plug is unsuitable for the socket outlet or is removed for any other reason, then the cut off plug should be disposed of safely to prevent the hazard of electric shock.
4. There is a danger of electric shock if the cut off plug is inserted into any 13 amp socket outlet.

The wires in the mains lead on this appliance are coloured in accordance with the following code:

Blue – Neutral

Green / Yellow - Earth

Brown – Live

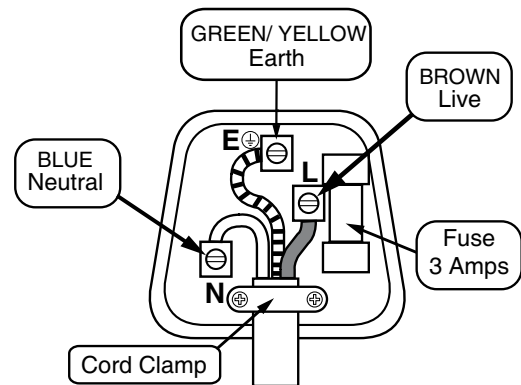

## If not fitting to a plug then the product must be wired to a IP44 rated terminal block.

Having correctly identified the wiring from your existing light fitting, connect to the approved outdoor rated external terminal block in the following way:

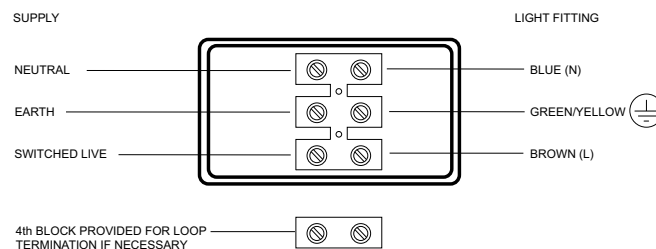

## Check That

### Check that.....

- You have correctly identified the wires.
- The connections are tight.
- No loose strands have been left out of the connection block.
- Ensure that all cord grips are tightly secured.
- Ensure that all seals are re-fitted correctly.

## Commissioning

9. Ensure that the fitting is pushed into the ground correctly, and cannot fall over. Ensure that the fitting is 0.5m from the illuminated surface.
10. Replace fuse or circuit breaker and switch on. Your light is now ready for use.

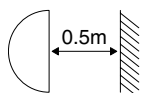

SPOTLIGHTS GIVE A CONCENTRATED BEAM OF LIGHT AND MUST NOT BE POSITIONED ANY CLOSER THAN 0.5M (50CM) TO THE ILLUMINATED SURFACE.

## Fitting / Replacing Bulbs

---

When changing a bulb, always switch off at the mains and allow the bulb to cool before handling. Dispose of used bulbs carefully. Use a soft cloth to handle bulbs, avoid directly touching the bulbs as this will shorten their life.

Do not exceed the wattage stated or use a different shape bulb from that indicated on the fitting.

**Ensure that the seal is correctly located and that the four screws are tightened after you have changed the bulb.**

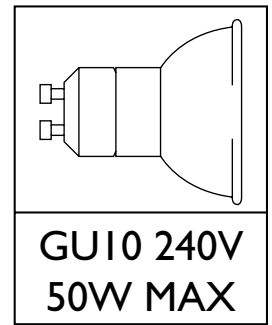

## Care and Cleaning

---

We recommend cleaning with a soft dry cloth.

Do not use solvents or abrasive cleaners as these could damage the finish.

Glass parts - Remove and wash in warm water or just use a damp cloth. Do not use abrasive materials as these will damage the finish.

To prolong the life and keep your outdoor lighting in good condition, it is recommended that periodically it is cleaned using a soft cloth followed by the application of a light coating of oil, such as WD40.

**Do not clean the units with a pressure washer.**

## Recycling Advice

---



Waste electrical products should not be disposed of with household waste. Please recycle where facilities exist. Check with your Local Authority or retailer for recycling advice.

## Safety Information

---

For your safety, always switch off the supply before changing lightbulbs, or cleaning.

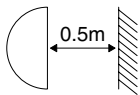

**SPOTLIGHTS GIVE A CONCENTRATED BEAM OF LIGHT AND MUST NOT BE POSITIONED ANY CLOSER THAN 0.5M (50CM) TO THE ILLUMINATED SURFACE.**

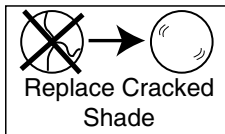

The glass shade must be replaced immediately should the glass shade become cracked or damaged. This fitting must not be used without the glass shade in place.



Saxby Lighting Ltd. BH23 3PE