

ASSEMBLY & INSTALLATION INSTRUCTIONS

804366



INTRODUCTION

Thank you for selecting our BELLATERRA HOME product. To ensure that your installation proceeds smoothly, read these instructions carefully before you begin. Also, review the recommended tools and materials section. Carefully unpack and examine your new plumbing fixture.

ALL INSTALLATION PROCEDURES MUST COMPLY IN STRICT ACCORDANCE WITH APPLICABLE LOCAL PLUMBING AND BUILDING CODES

Tools and materials Required

Most of the procedures require the use of available hand tools and plumbing supplies. It is essential that the tools and materials be on hand before work is begun.

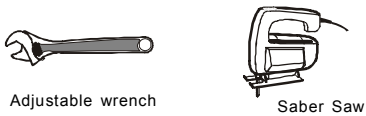

Adjustable wrench

Saber Saw

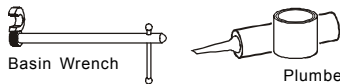

Basin Wrench

Plumbers' Putty or Caulking

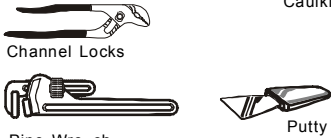

Channel Locks

Putty Knife

Pipe Wrench



Tape Measure

Tubing Cutter

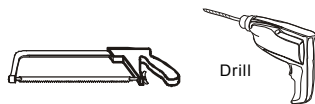

Hacksaw

Drill

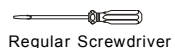

Regular Screwdriver



Phillips Screwdriver



Level

Roughing in Dimensions

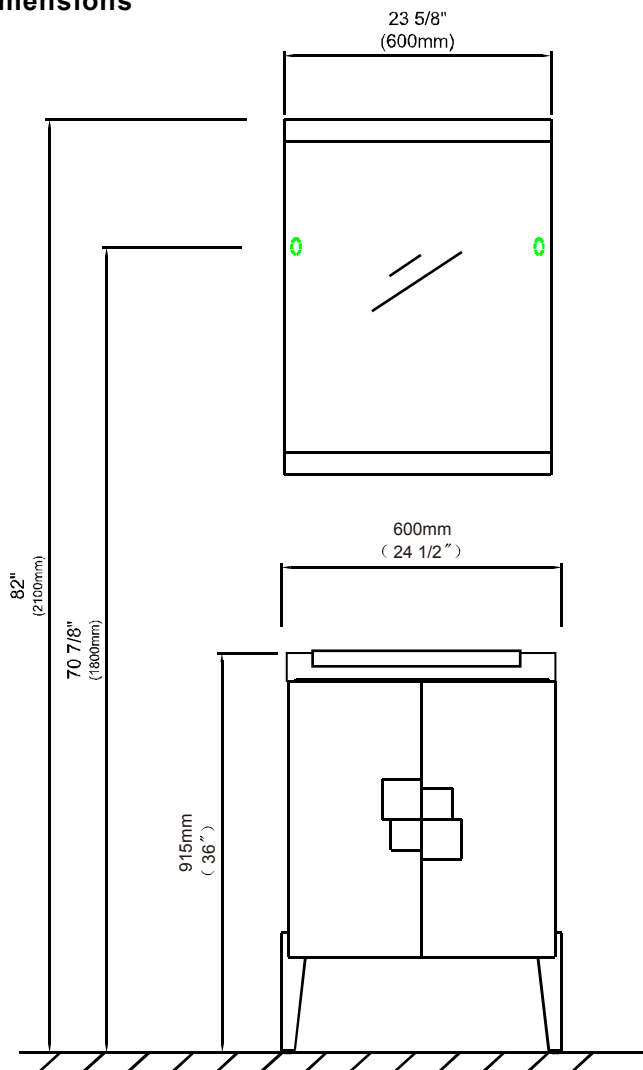

*Dimensions shown for location of supplies and "P" trap are suggested.

Step One: Use the track level bar, tape measure and pencil to mark holes in desired location. Having established the position, use drill to make holes. Use the hammer to insert anchors into the hole and screw in the screws. Finally put the mirror in place.

Step Two: Place the vanity in position. Level vanity ensuring it is level with water outlets and piping. If the doors are out of alignment they can be fixed by adjusting the hinges.

Step Three: Fix the vanity to the wall through the back rail of the cabinet (for wall hung units). The fixings should be placed on a wall stud. We recommend that you use a toggle or toggle type system if you can't locate a strong solid surface.



Step Four: (For undermount sink unit) Glue the undermount sink to the Stone Top in suitable place, put them on the cabinet after the glue is dry. Make sure the sink and stone stick to each other strong enough.

(For semi recessed basin unit) Put the basin on the cabinet in suitable place. Glue the basin to the cabinet if necessary.

(For above counter basin unit) Put the stone top on the cabinet and place the basin on stone in suitable place.

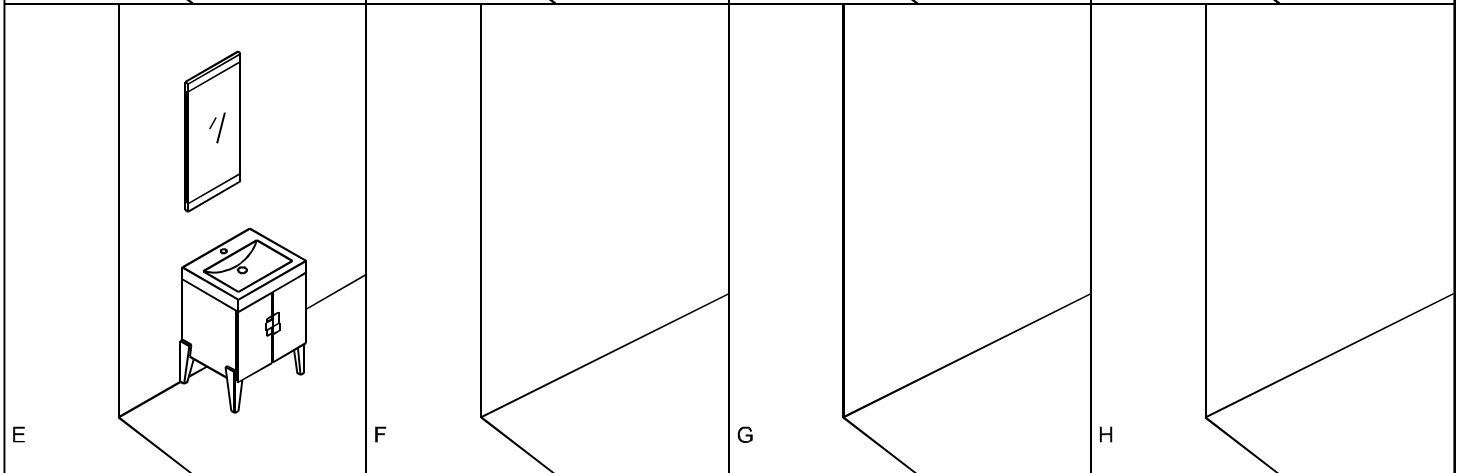
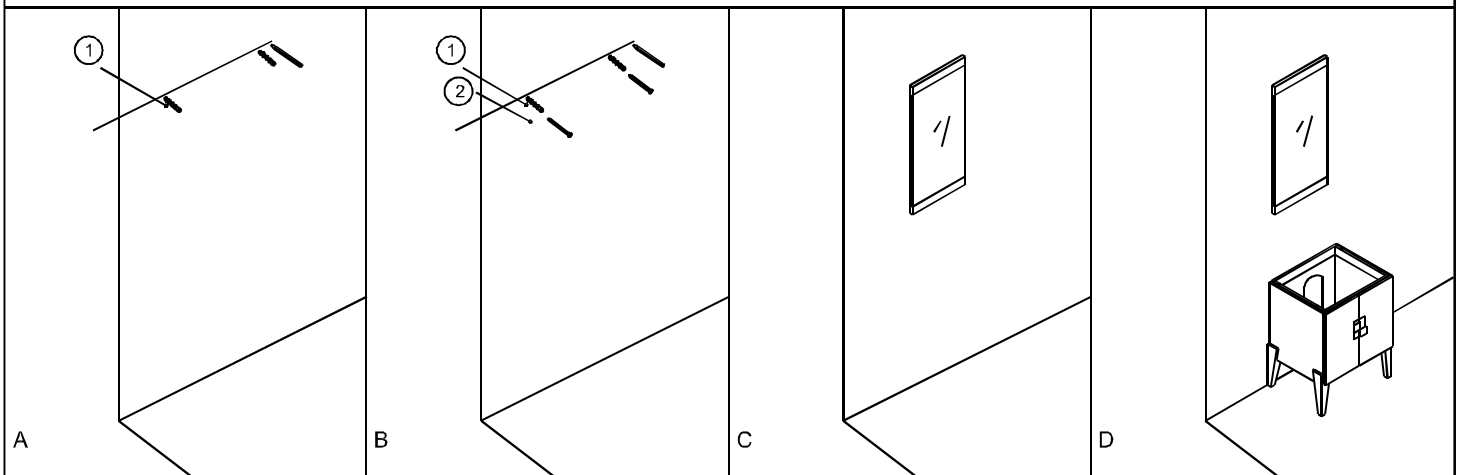
Step Five: (If has board shelf) Use the track level bar, tape measure and pencil to mark holes in desired location. Having established the position, use drill to make holes. Use the hammer to insert anchors into the hole and screw in the screws. Finally put the board shelf in place.



I		J		Accessory list	Code	①	②	③
					Component			
					Name	Expended partides	Hexagon screw	
					QTY	2	2	

Install faucet and drain in accordance with manufacturer's instructions. Ensure all water supply and drain connections are tightened. Turn on water supply valves and water-test installation.

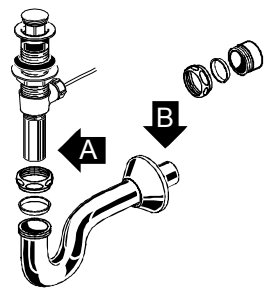
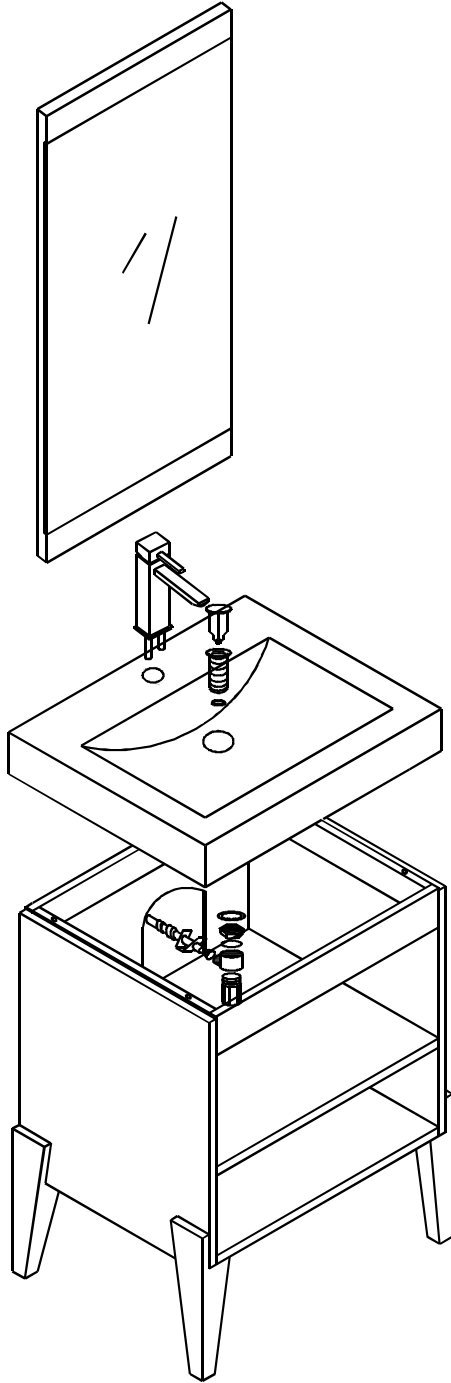

Typical Drain Assembly

Connect the trap to the drain assembly hand tight to check alignment. It may be necessary to cut off part of the tailpiece (area "A") or part horizontal leg of the trap (area "B").

Trap joints for watertight assembly.

Connect hot and cold supply lines to the shut off valves. Tighten