



LAVATORY FAUCET

- **"Non-Metallic Collection"**
- **Two-Handle Deck Mount**
- **3-Hole Installation**
- **4" Centerset**

STANDARD SPECIFICATIONS

- ABS body, POM waterway
- 4" centerset
- Washerless cartridges
- 1/2" NPSM threaded male inlet shanks
- Less pop-up assembly
- Maximum flow rate 2.0gpm @ 60 PSI

FINISHES INCLUDE

- Chrome (UF08042C)
- Brushed nickel (UF08342C)
- Oil rubbed bronze (UF08542C)

WARRANTY

- Ultra Faucets warrants to the original purchaser that its products will be free from defects in workmanship and materials. All Ultra Faucets non-metallic series are provided with a five year limited warranty. See assembly instruction for detail.

COMPLIES WITH

- NSF 61-9
- ASME A112.18.1
- CSA B125.1
- cUPC
- AB1953

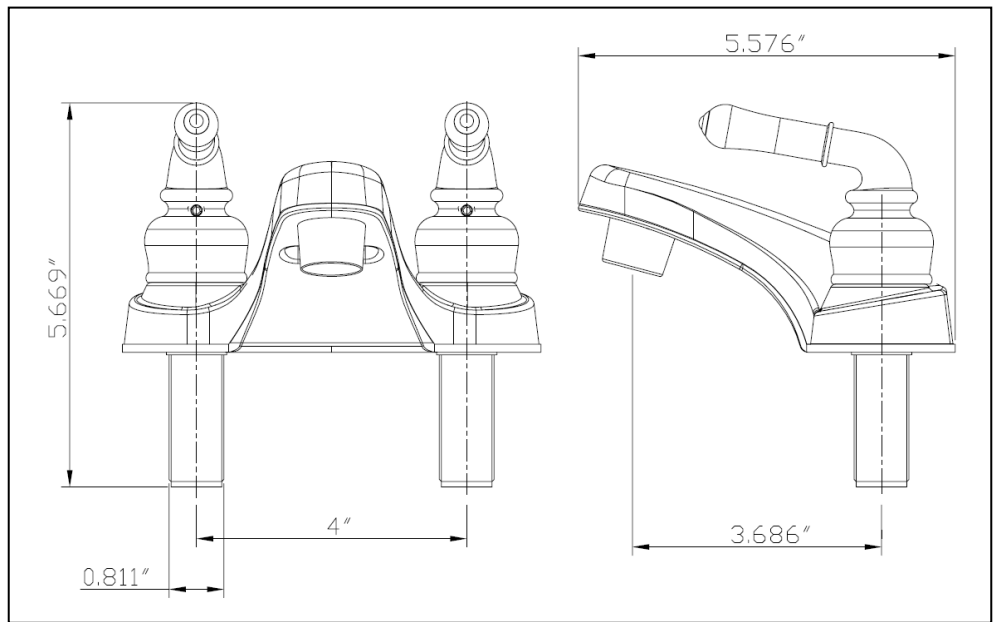

tel. 888-OK-ULTRA (658-5872) • fax. 949-225-6099 • <http://www.ultrafaucets.com>

This specification is provided for reference only. Ultra Faucets reserves the right to modify specifications and materials without notice or obligation.