

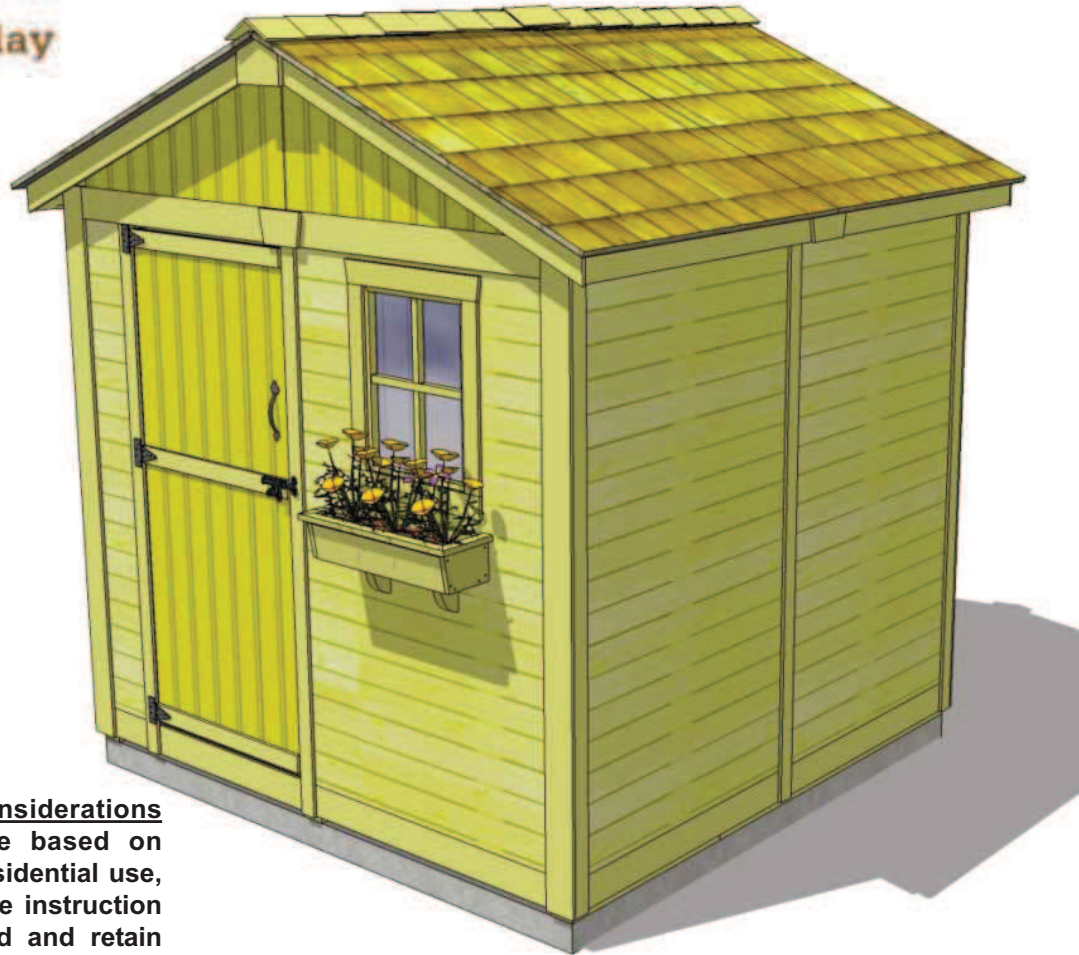

8x8 Gardener's Shed Assembly Manual

Version 13
Feb 12th, 2015



Thank you for purchasing an 8x8 Gardener's Shed. Please take the time to identify all the parts prior to assembly.

Safety Points and Other Considerations

Our products are built for use based on proper installation and normal residential use, on level ground. Please follow the instruction manual when building your shed and retain the manual for future maintenance purposes.

Some of the safety and usage measures you may wish to consider include:

- snow load ratings vary by geographical location. If heavy or wet snowfall occurs, it is advisable to sweep the snow off the roof(s).
- if the product is elevated, any structural and building code requirements are solely the customer's responsibility, and should be abided by.
- in high or gusty wind conditions it is advisable to keep the structure securely grounded.
- have a regular maintenance plan to ensure screws, doors, windows and parts are tight.

Customer agrees to hold Outdoor Living Today Partnership and any Authorized Dealers free of any liability for improper installation, maintenance and repair.

In the event of a missing or broken piece, simply call the Outdoor Living Today Customer Support Line @ 1-888-658-1658 within 30 days of the delivery of your purchase. It is our commitment to you to courier replacement parts, free of charge, within 10 business days of this notification. Replacement parts will not be provided free of charge after the 30 day grace period.

Thank you for purchasing our 8x8 Gardener's Shed.
Please take the time to identify all the parts prior to assembly.

Parts List:

A. Floor Section

2 - 45 1/2" x 75" - Floor Joist Frames
2 - 45 1/2" x 21" - Floor Joist Frames
2 - 45 1/2" x 75" - Plywood Floor - Large
2 - 45 1/2" x 21" - Plywood Floor - Small
4 - 1 1/2" x 3 1/2" x 72" - Floor Joists
5 - 1 1/2" x 3 1/2" x 60" & 31" Floor Runners

B. Wall Section

6 - 45 1/2" x 75" - Wall Panels - (Walls with Bottom Plates Unattached)
1 - 45 1/2" x 75" - Window Wall Panel
1 - 12" x 73" - Narrow Wall Panel
6 - 1 1/2"x 2 1/2" x 45 1/2" - Bottom Wall Plates

Door Jamb & Header

1 - 1 1/2" x 3" x 73" - Door Jamb
1 - 2" x 3" x 45 1/2" - Door Header (Dado cut on edge)

Gable Walls

4 - Gable Half Walls - Triangular Shaped

Top Wall Plates

6 - 3/4" x 2 1/2" x 32" - Front & Rear Top Plates Side Top Plates (2 pieces Angle cut on end, 1 piece straight cut both ends)
2 - 3/4" x 2 1/2" x 86" - Side Top Plates (Angle cut on edge)

C. Rafter and Roof Section

12- 1 1/2" x 3 1/2" x 56 1/2" - Roof Rafters with angled ends
2 - 3/4" x 4 1/2" x 57 1/2" - Roof Ridge Boards
2 - 3/4" x 4 1/2" x 33 1/2" - Roof Ridge Boards
4- 1/2" x 4 1/2" x 45 1/2" - Soffits
2 - 3/4" x 3 1/2" x 72" - Roof Gussets - (angle cut on ends)
4 - Roof Panels (Shingles overhanging roof battens on one end)

D. Miscellaneous Section

Bottom Skirting

8 - 1/2" x 4 1/2" x 45 1/4" - Bottom Skirting

Corner & Sidewall Trim

6 - 1/2"x 2 1/2" x 79" - Narrow Trim
4 - 1/2" x 2 1/2" w x 75" - Filler Trim
4 - 1/2" x 4 1/2" w x 82" - Wide Trim
4 - 1/2" x 4 1/2" w x 44 1/2" - Horizontal Gable Trim
3 - 1/2" x 2 1/2" x 77 1/2" - Narrow Trim (Front and Rear Wall)

Facia Trim

4 - 3/4" x 3 1/2" x 58" - Front and Rear Facia (Angle cut on ends - 2 right / 2 left)
4 - 3/4" x 3 1/2" x 49 1/2" - Side Facia

Filler Shingles (5 1/2" wide)

8 pcs - Long Filler Shingles
2 pcs - Short Filler Shingles

Door

1 - 31 1/2" x 72" - Door
2 - 2 1/2" x 1/2" x 72" - Interior Vertical Door Stops
1 - 2 1/2" x 1/2" x 36" - Interior Top Horizontal Door Stop

Ridge Caps

1 Bundle Cedar Shingle Roof Ridge Caps - 16 pcs.

****Miscellaneous Pieces**

1 - Window Insert
1 - Window Trim Pkg - (1-24 1/16" angle cut / 3 -23" straight cut)
1- Flower Box Kit
2- Pentagon Facia Plates
2 -Side Facia Detail Trim Plates - Smaller
2 - Horizontal Gable Trim Detail Plates - Larger
1 pc - Spare Wall Siding
2 pcs - Spare Shingles- use to shim door, etc

8x8 GARDENER HARDWARE SHEET

Hardware Kit (Provided)

Note: screws and nails shown actual size.

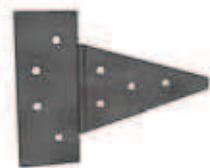
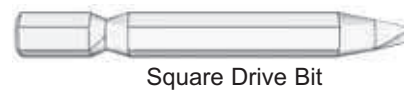
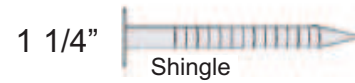

Tee Hinge x3



Pull Handle



Black Barrel Bolt



Simpson Strong Tie (8)



Ridge Board Connector x 2

Tools Required (Not Provided)



Hammer



Screw Gun/Drill



Tape Measure



Wood Clamp



Level



Pliers



Ladder



1/8" Drill Bits

Safety Equipment Required (Not Provided)



Safety Glasses



Work Gloves

A. Floor Section

Exploded view of all parts necessary to complete Floor Section. Identify all parts prior to starting.

Note: Floor Footprint is 96" wide x 91" deep.

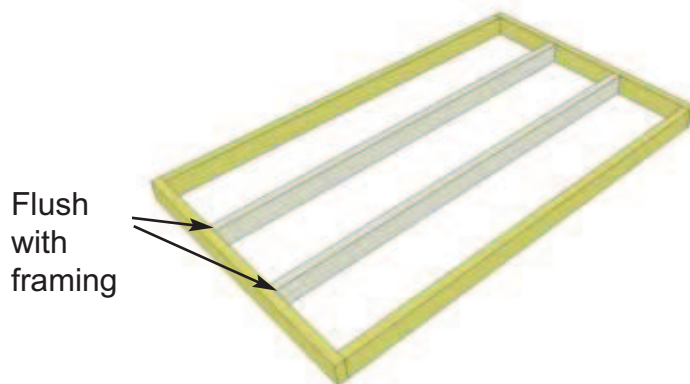
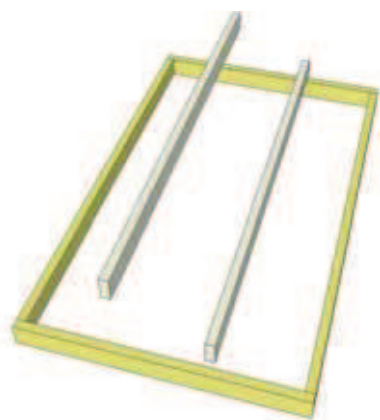
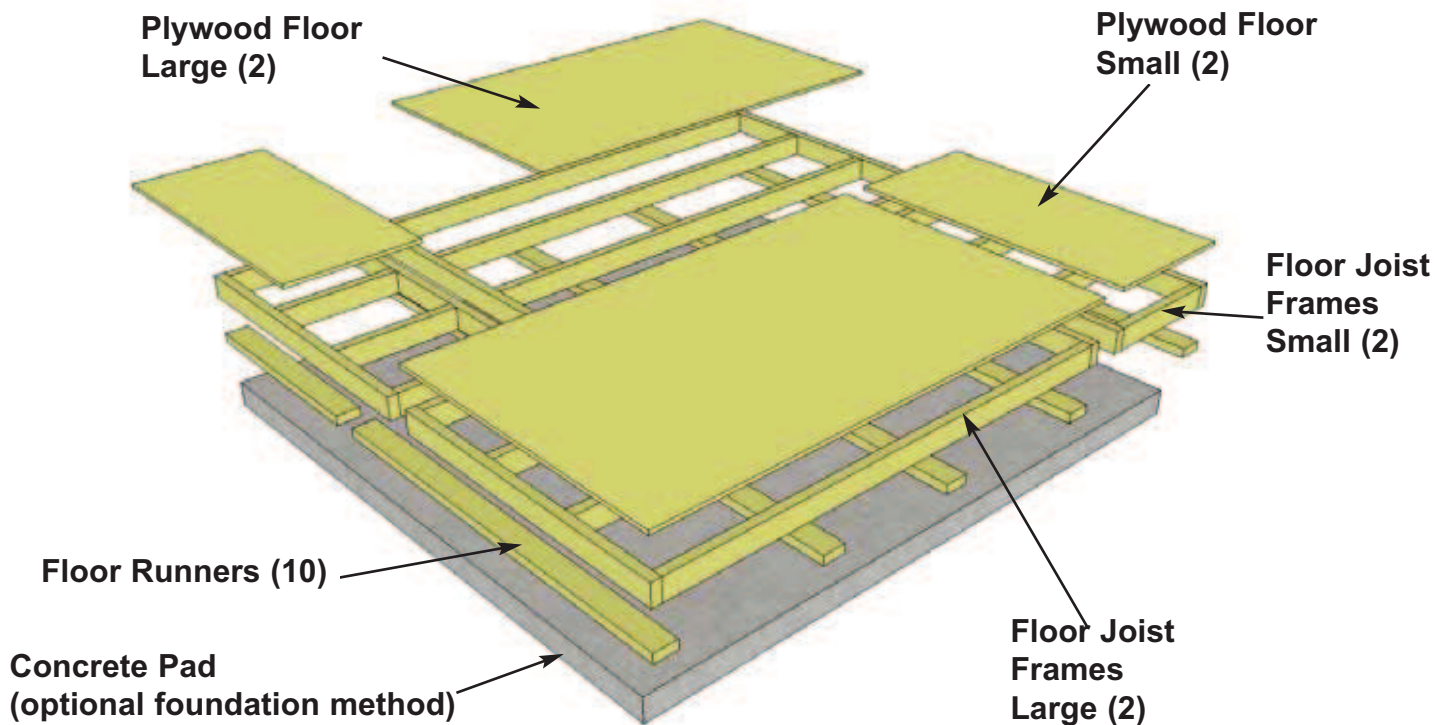

1. Lay out **Large Floor Joist Frame** and **2 Floor Joists** as illustrated above. Position Joists equally in Floor Joist Frame. Use **Small Floor Joist Frame** as a template to determine joist position. Position Joist so flush with framing.

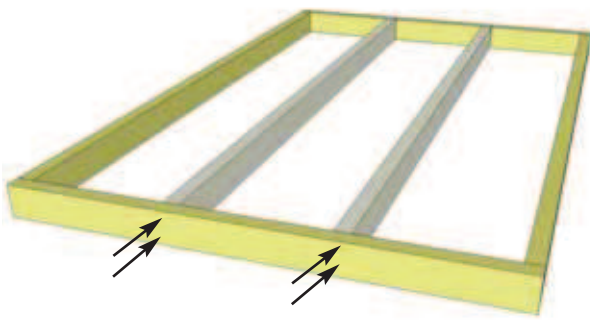

You can find the Square Drive Bit for the screws in with the Hardware Kit Bag.

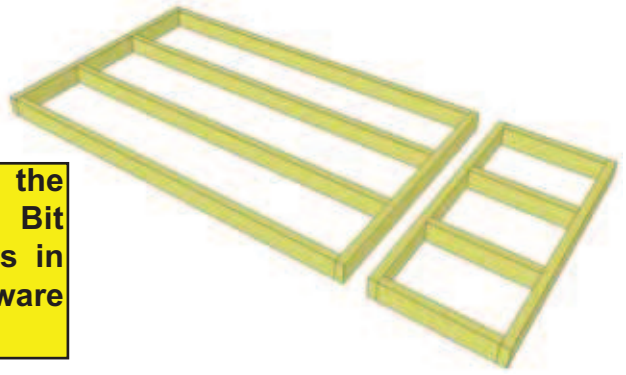

2. When correctly positioned, attach each Joist with 4 - 2 1/2" screws (2 per end).

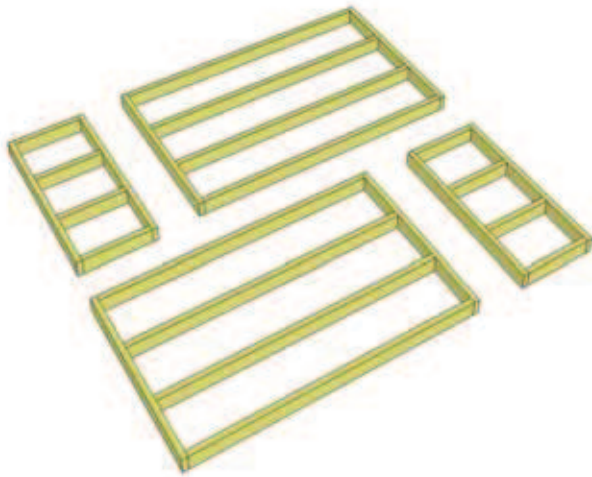

3. Lay out **Floor Joist Frames** as illustrated at left. There are 2 larger and 2 smaller Frame Sections. The Footprint for the floor when attached together will be 96" wide x 91" deep.

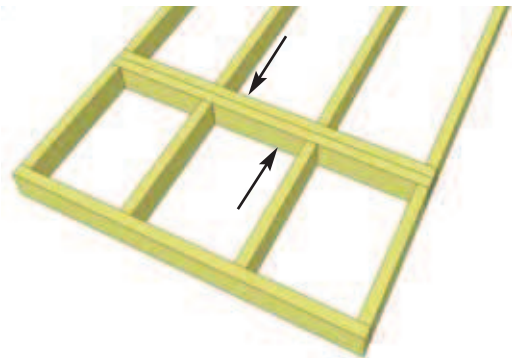

4. Attach each large and small floor joist frame together with 6 - 2 1/2" screws per section.

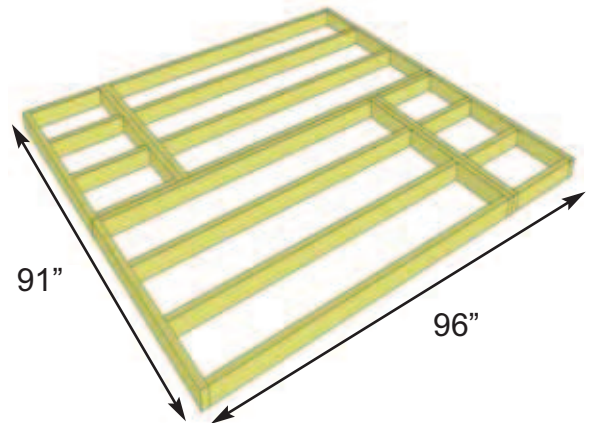
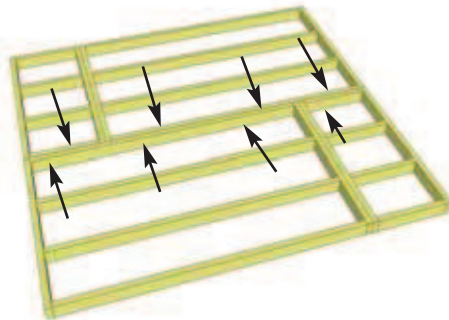

5. Complete all large and small frame attachments. Screw each completed section together with 8 - 2 1/2" screws.

6. When completed, your floor footprint should be 96" wide x 91" deep.

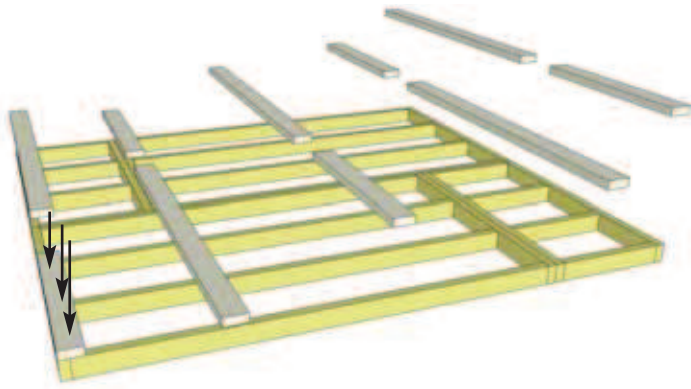

7. Attach **Floor Runners** to completed floor frame. There are 2 floor runners per 91" side and 5 completed runners in total. Use 3 - 2 1/2" screws per Runner.

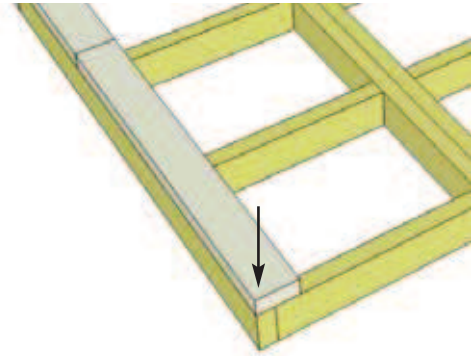

8. Make sure Runners are flush with outside and front and rear floor framing but not overhanging.

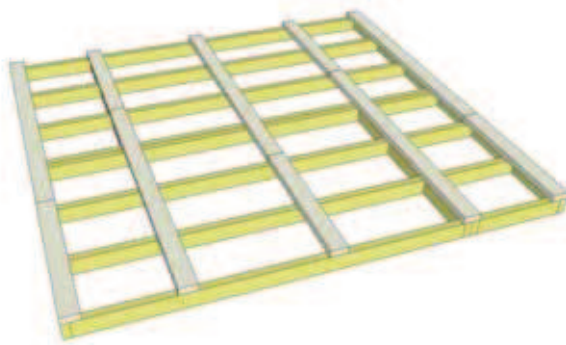

9. Complete all Floor Runners.

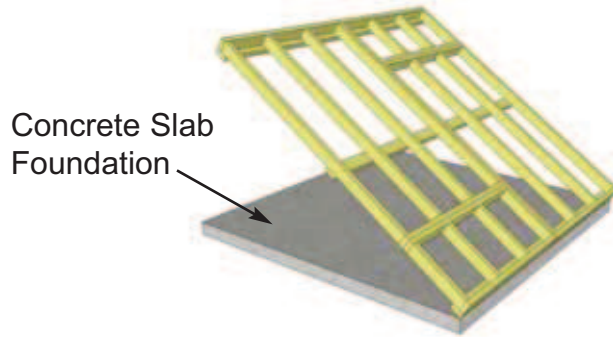

10. With Floor Runners attached, carefully flip the floor over and place on your foundation. **Caution:** you will need 2 people to assist you. Be careful when laying floor down not to bend or twist floor. When in place, level floor completely.

Foundations

Note: The floor will be flipped over and floor runners will sit on your foundation. It is important to note that having a level foundation is critical. Choosing a foundation will vary between regions. Typical foundations can be concrete pads or patio stones positioned underneath the floor runners.

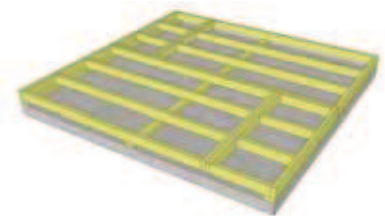
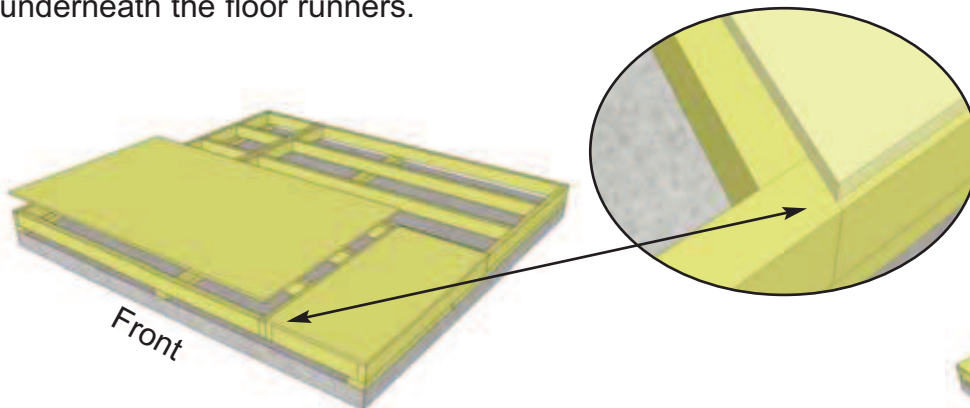

plywood pushed together at seams.

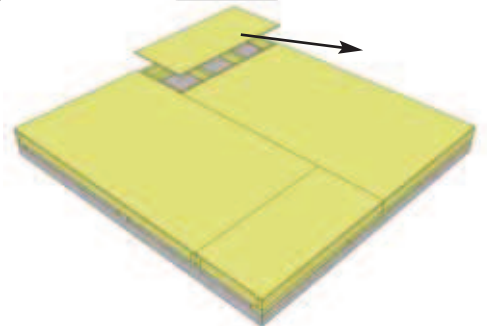

11. Position **Plywood Floor** pieces (4) on top of completed floor joists. Plywood is cut slightly smaller than floor framing. Keep plywood seams tight.

12 . With Plywood positioned correctly on floor framing, attach with 1 1/4" screws. Use screws every 16".



Hint: Use a chalk line to mark location of floor joists to determine screw placement.

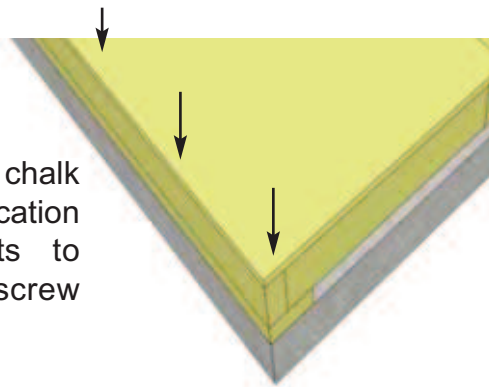

B. Wall Section

Exploded view of all parts necessary to complete the Wall Section. Identify all parts prior to starting.

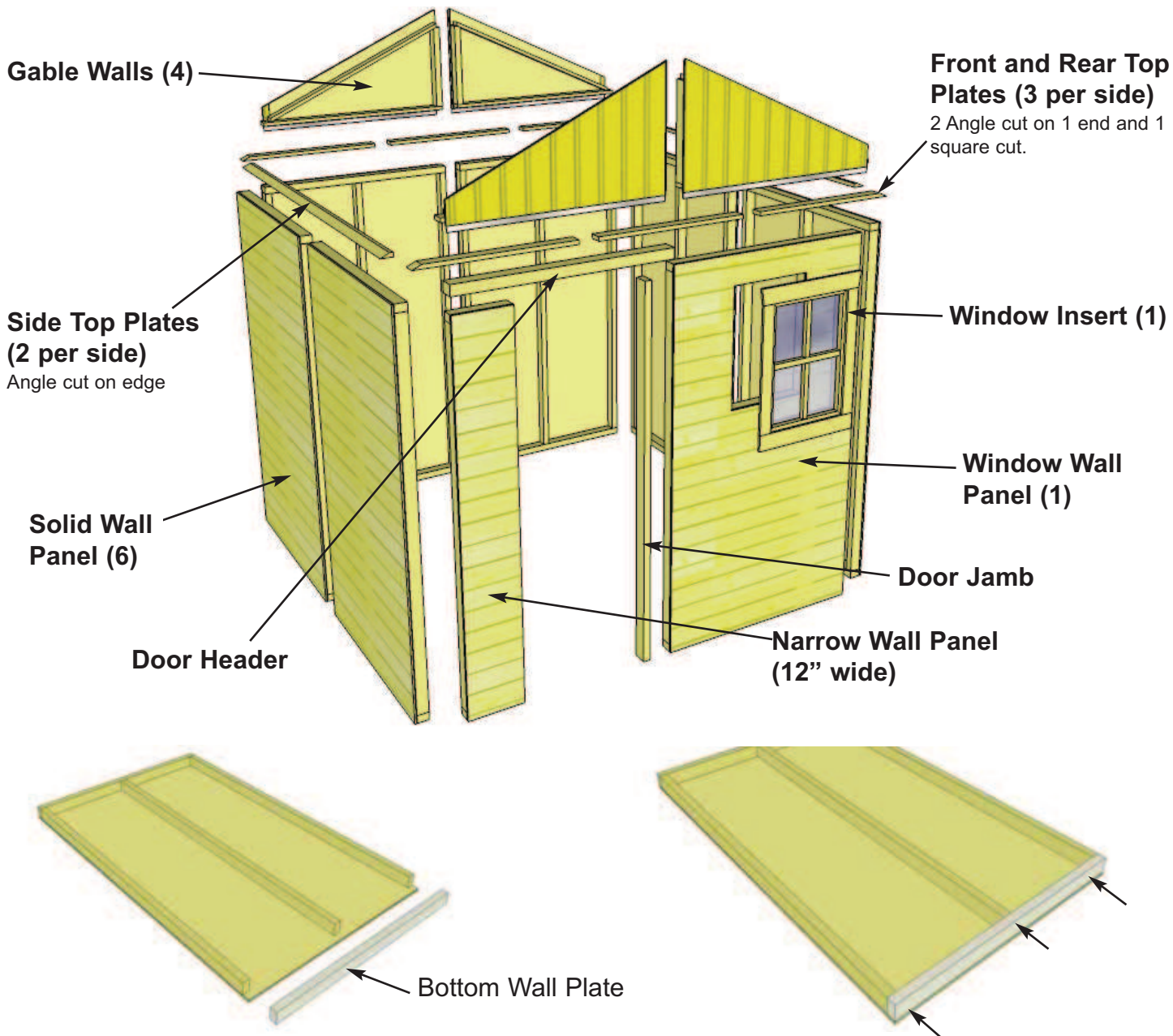

13. Starting with **Solid Wall Panels**, carefully lay panel face down. Position and attach **Wall Plate** to bottom of wall studs of each wall panel with 3 - 2 1/2" screws. Position so plates are flush with framing. **Note:** some Bottom Wall Plates may already be attached to some Solid Walls.

14. Lay out all the wall panels and become familiar with their location. On a Standard Kit, there is **1 Window Wall Panel**, **6 Solid Wall Panels** and **1 Narrow Wall Panel**. Make sure to position panels right side up so water is directed away from and not into shed. Compare siding with window wall panel to determine proper wall orientation.

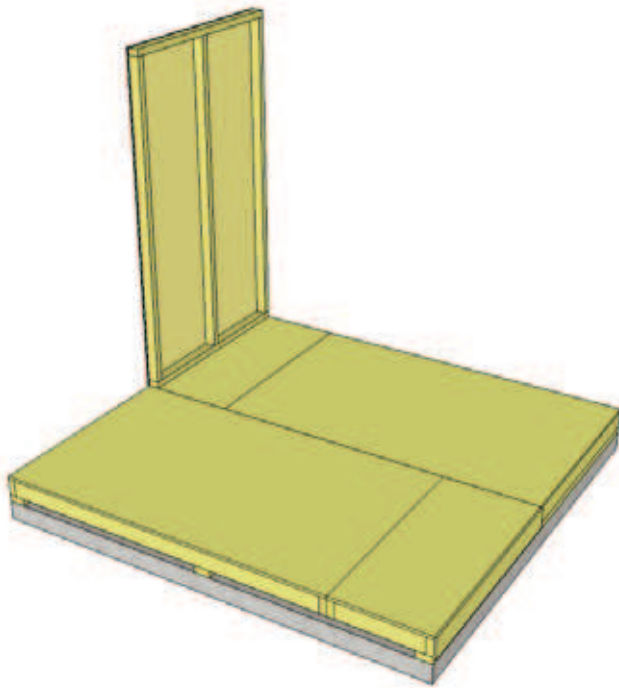
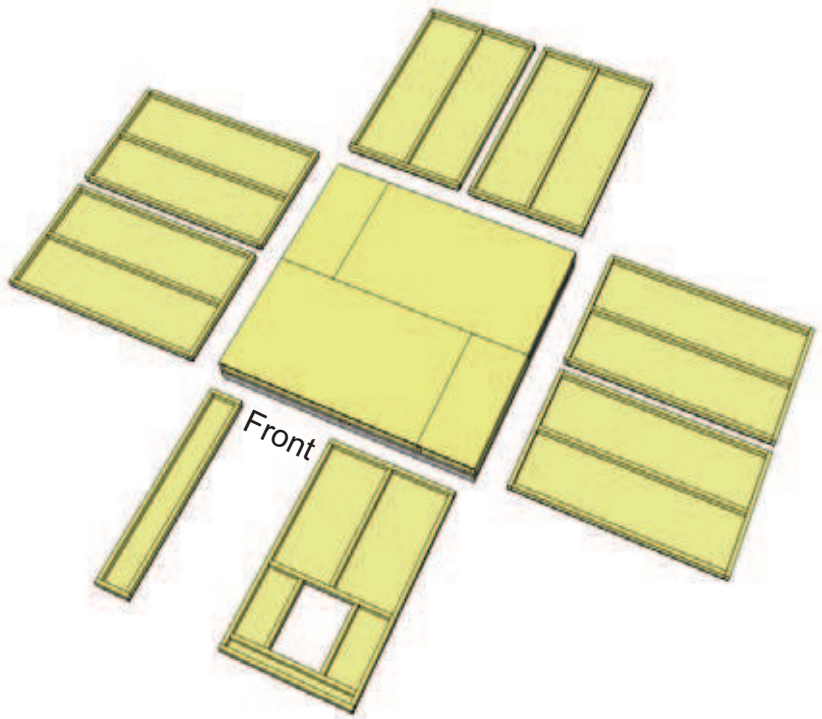

Important: Make sure all walls are aligned in their upright position. If not, water may leak into your shed. Unsure if panel is facing up or down? check siding on window wall panel to match alignment.

15. Starting at Rear Corner, position a **Solid Wall Panel** on top of plywood floor. The Wall Panel bottom framing will sit flush with floor framing.

16. The side wall panels will sit flush at the corner of the floor, with the front and rear wall panels sandwiched between them. **Note:** Siding will overhang the floor by approximately 1/2".

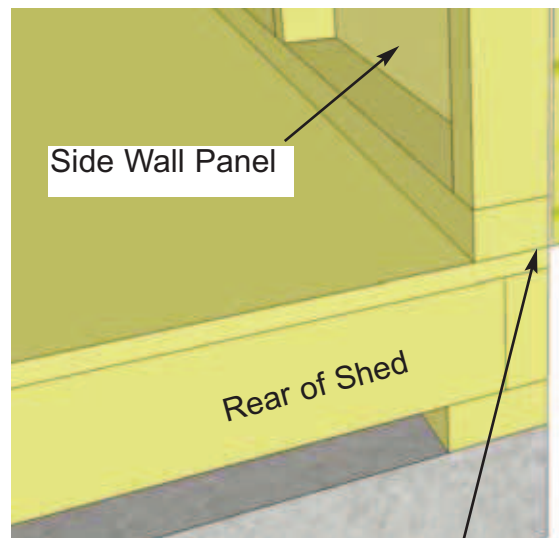

Outside 2x3 framing of wall panel is flush with outside of floor frame when properly aligned.



Do Not Attach Walls To Floor Until Step 23.

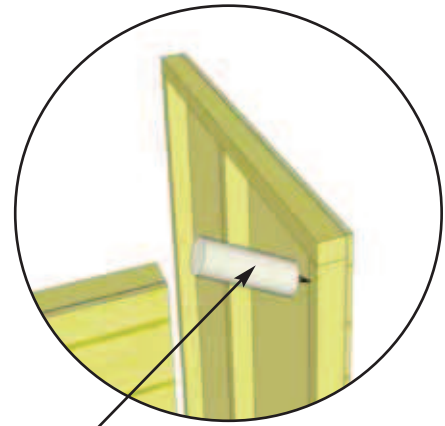

Optional - Caulking seams will help prevent moisture from entering at seam. **Caulking not included in kit.**

17. Position a 2nd Solid Wall into place on plywood floor. Butt both vertical wall studs of side and rear walls together and attach with 3 - 2 1/2" screws. Screw at the bottom, middle and top of stud to secure properly.

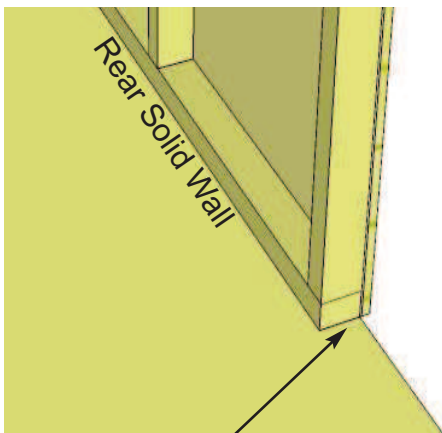

2x3 wall framing flush with floor framing.

18. With the corner wall attachment complete, position a third wall panel in place. Wall siding should overhang floor by approximately 1/2". When positioned correctly, attach both rear wall panel studs together as per **Step 17**.

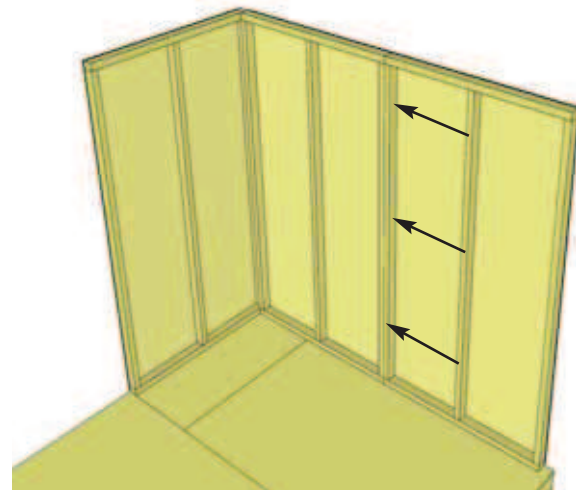

19. Continue positioning and securing wall panels around your floor. Attach wall studs together as per **Step 17**. Be sure that rear wall panels fit between the side wall panels (sandwiched).

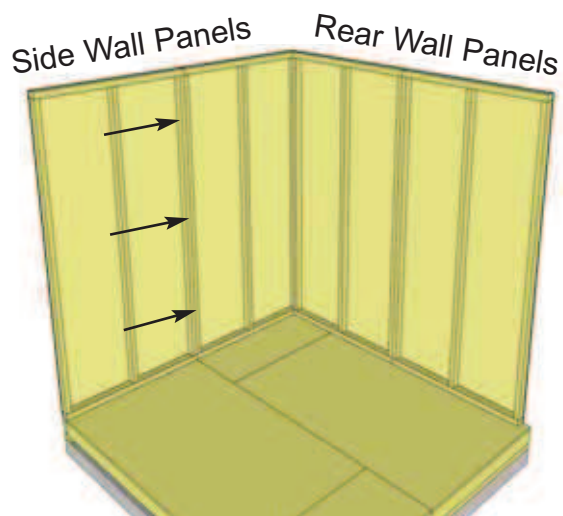

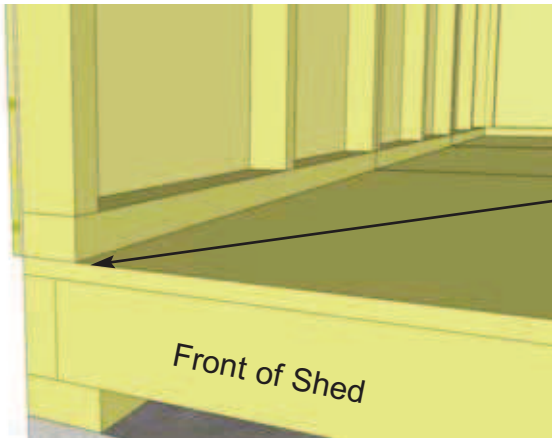

Wall panel will sit flush with floor framing at Front of shed.

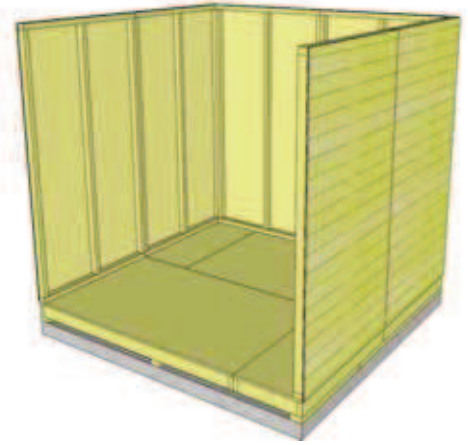

20. Complete all side and rear wall attachments.

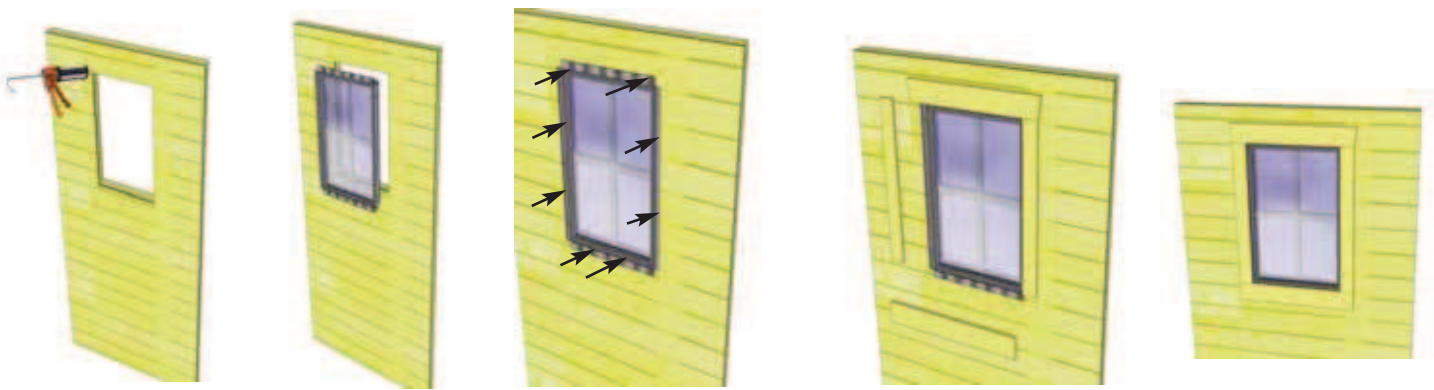

21. Locate **Window Inserts and Window Trim Packages**. Before installing, run a bead of caulking around window opening perimeter. Position window in cavity and secure with 8 - 1 1/4" screws. Position Window Trim around window doing a dry run first and attach with 4 - 1 1/2" finishing nails per piece. **Trim Sizes = 1x 24 1/16" = top / 3 x 23" = sides.**

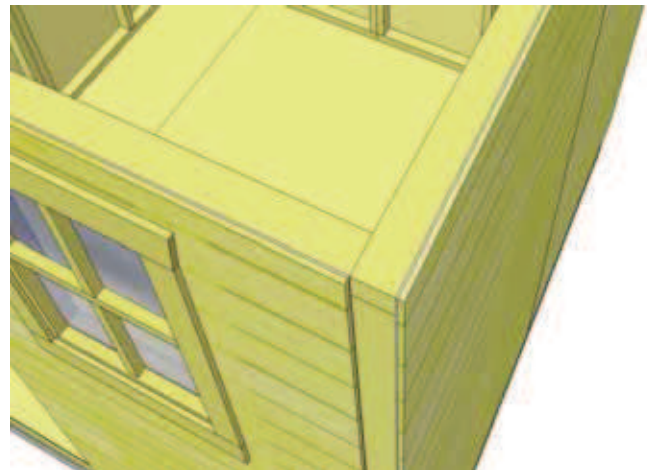
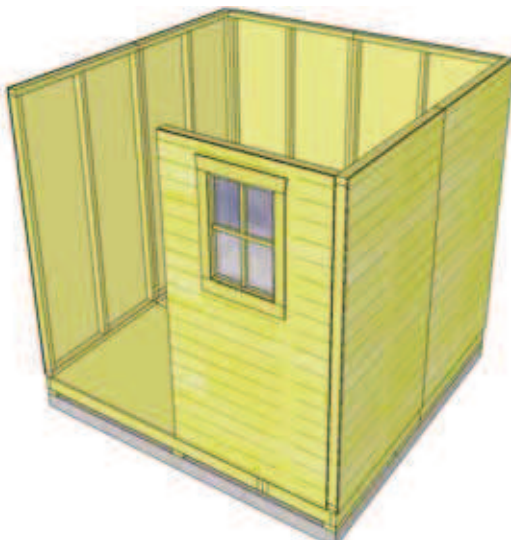

22. Place Window Wall Panel in front.

23. Make sure top Wall framing is aligned together as illustrated and attach as per **Step 17**.

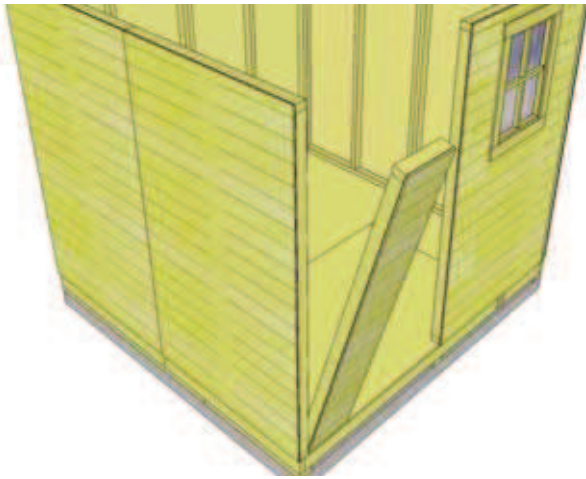

24. Position and attach **Narrow Wall Panel** to left side wall stud with 3 - 2 1/2" screws as per **Step 17**. **Note:** Narrow Wall is 73" high (2" shorter than wide walls). Siding overhangs adjacent wall stud and floor.

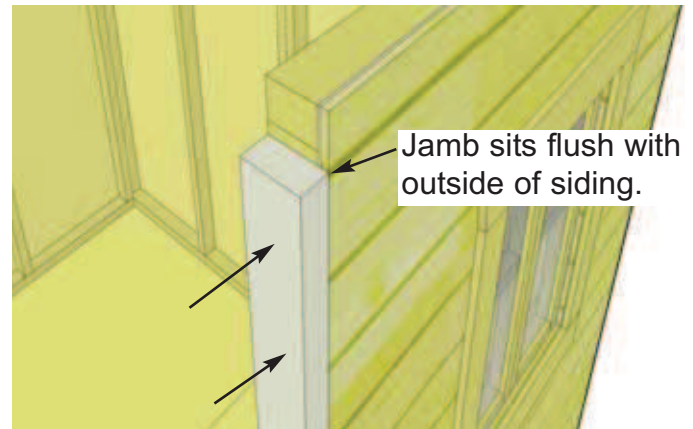
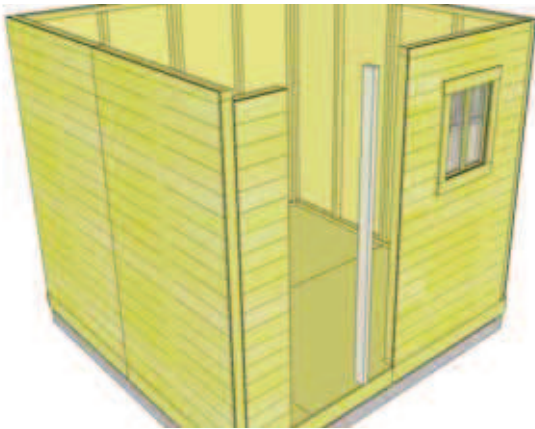

Jamb sits flush with outside of siding.

25. Locate **Vertical Door Jamb** and position flush against right wall panel stud. The Jamb is 3" wide and will sit flush to outside of wall siding. When positioned correctly, secure Jamb using 4 - 2 1/2" screws.

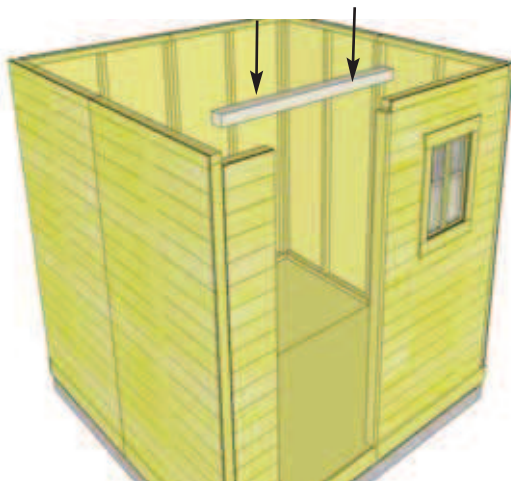

Header has step in edge that is positioned to the top and facing outside.

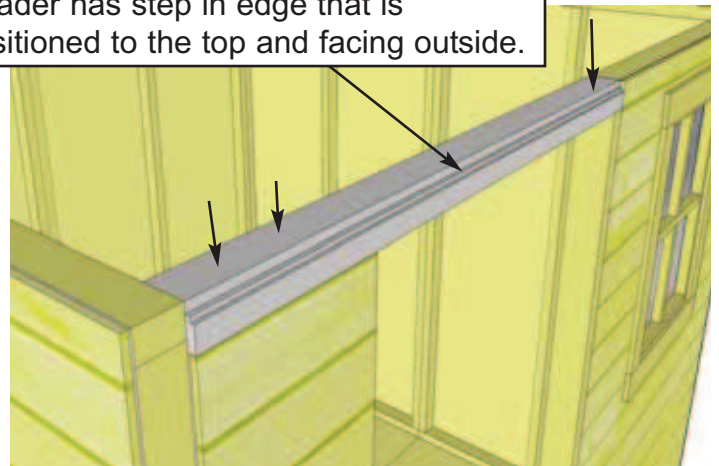

26. Position and attach the **Door Header** to Door Jamb and Narrow Wall Panel top framing. Header should sit flush with Door Jamb and Outside of Narrow Wall Panel Siding. Attach with 4 - 2 1/2" screws.

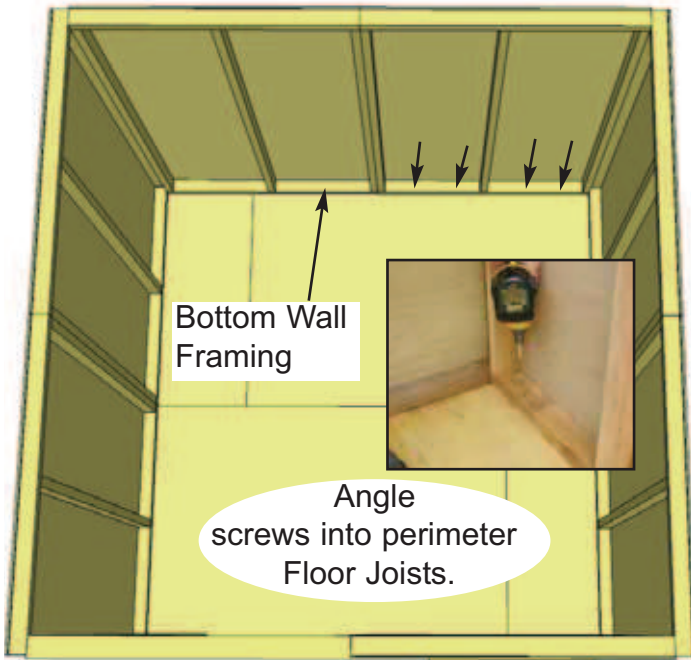

Bottom Wall Framing

Angle screws into perimeter Floor Joists.

Optional: Caulking seams will help prevent moisture from entering at seam. **Caulking not included in kit.**

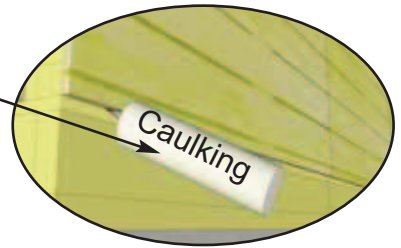

27. When all walls are attached together, check alignment with the floor. Bottom wall framing should sit flush with outside of floor joists. **Confirm 32" wide door opening at bottom.** When positioned correctly, fasten bottom wall plates to floor using 4 - 2 1/2" screws per wall panel.

Doorway Opening is 32"

28. Position **Front Top Plates** on top of wall studs so they are flush on the inside with 2x3 wall framing. There are 3 pieces of Front Top Plates (2 angle cut on one end and one straight cut on both ends). Together, the plates should be centered evenly on the wall left to right. Attach by screwing down into top wall framing with 4 - 2" screws.

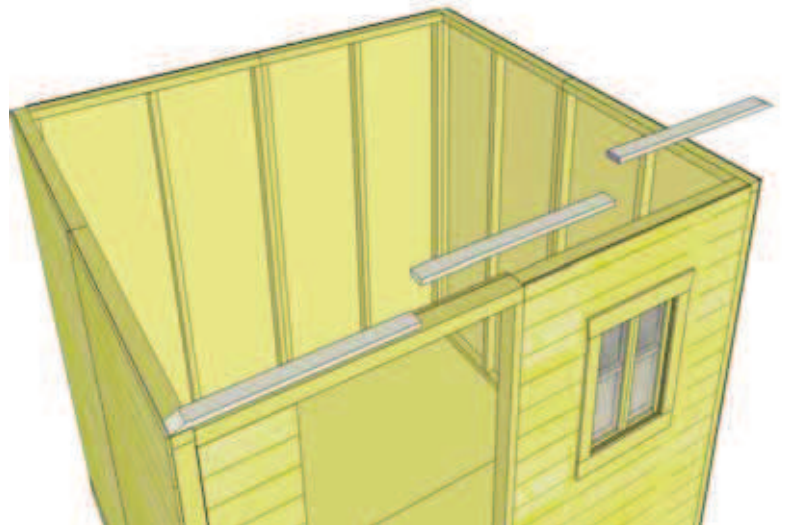

Top Plates should be flush with inside of wall framing.

Angle cut on ends.

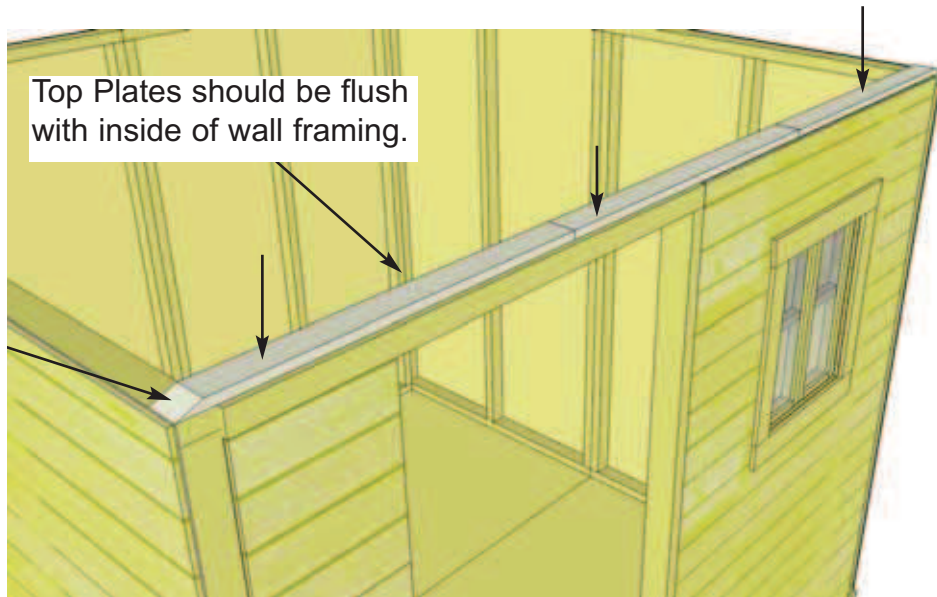

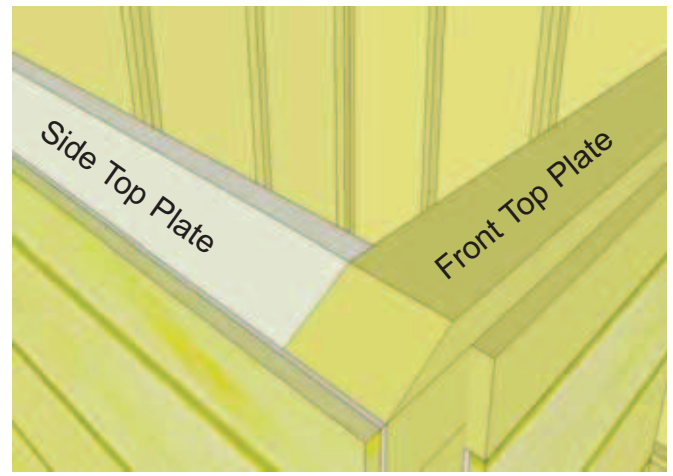
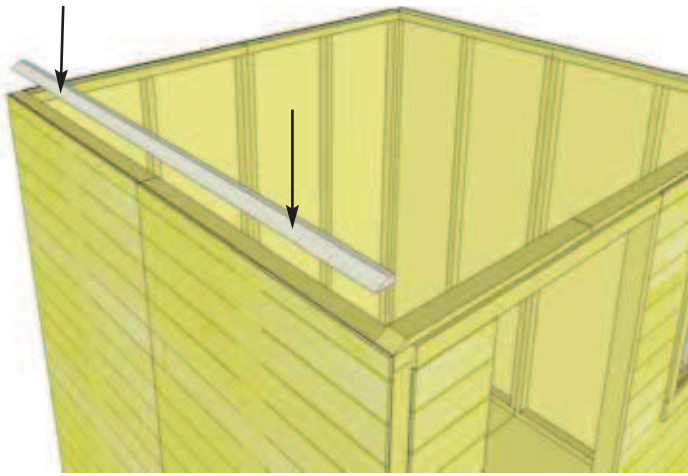

29. Next, attach the 2 **Side Top Plates** (1 per side). The side top plates are angle cut down the Edge. Once again, position top plate on wall plate so it is flush with inside of wall framing. Side plate should also be flush with Front Top Plate. Secure with 4 - 2" screws per piece.

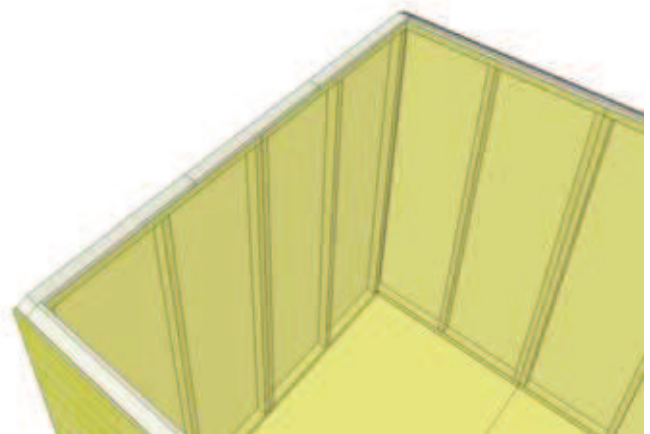
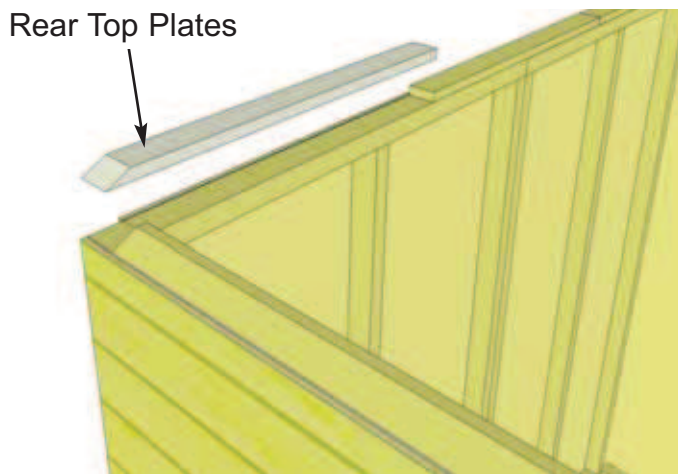

30. Position the **Rear Top Plates** on back wall to complete as per **Step 28**. Use 4 - 2" screws per piece.

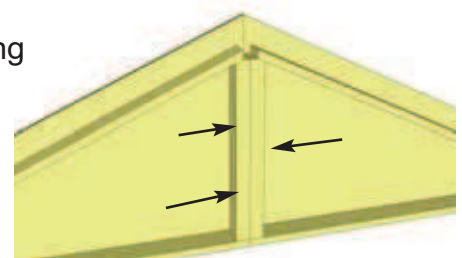
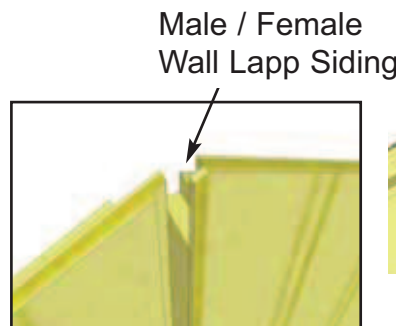
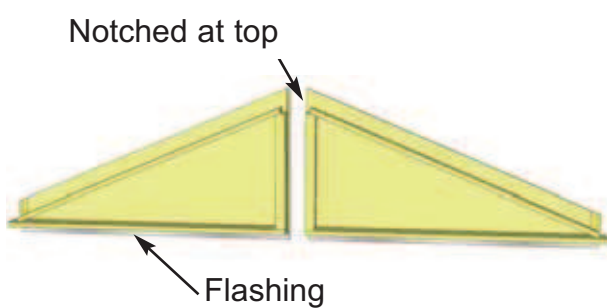

31. Locate **Gable 1/2 Walls** for both sides of the shed. Align framing and wall lapp siding together. Screw center wall framing of each piece together with 3 - 2 1/2" screws.
Note: prior to attaching, try each combination of Gables for best fit.

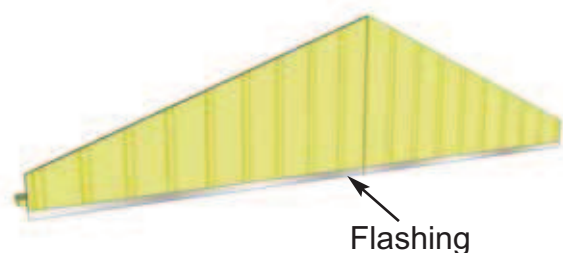

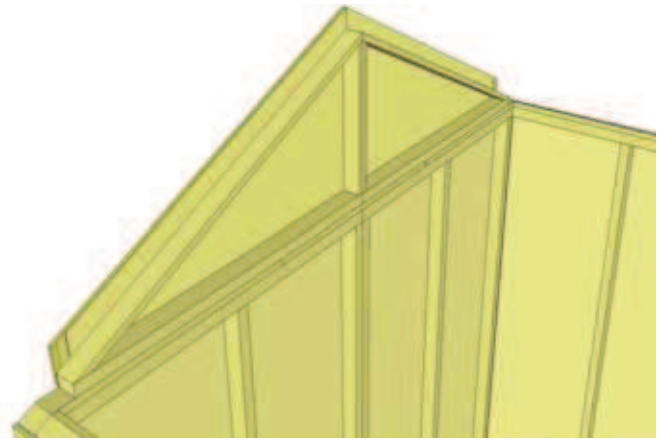
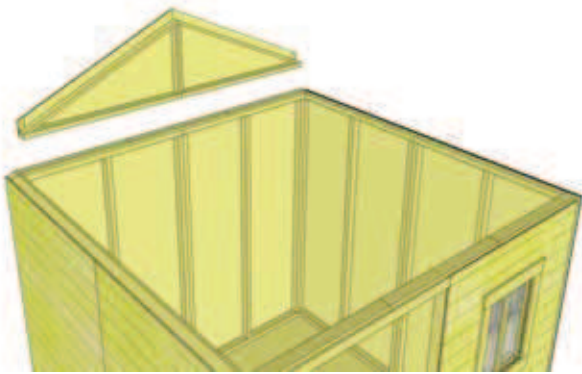

32. Lift up a completed gable section and place on top of Rear Top Plate on wall. The rear gable framing should sit flush with the inside of the top plate.

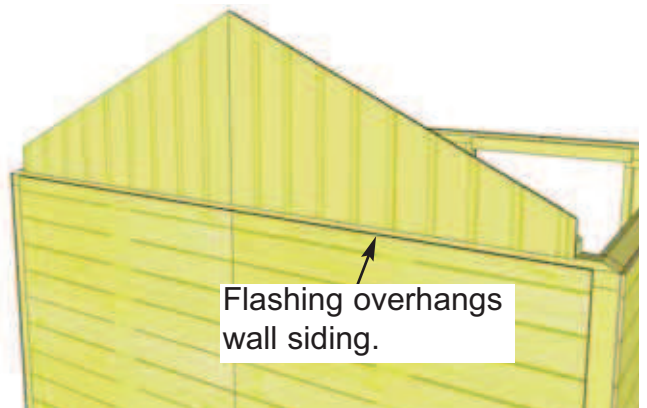
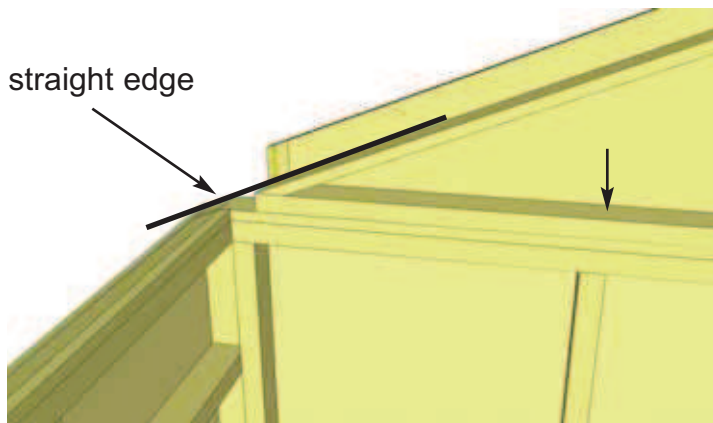

33. The gable should be centered sideways (left to right) on the top plate. **Hint:** use a straight edge to check the angle of the gable framing and top plate. Both angles should line up. Adjust gable accordingly. Temporarily attach Gable to walls and top plate with 2 - 2" screws. Screw from the bottom of gable framing down into Top Plate and Wall. Gables may need slight adjustment in **Step 44** and then will be completely attached with an additional 6 - 2" screws.

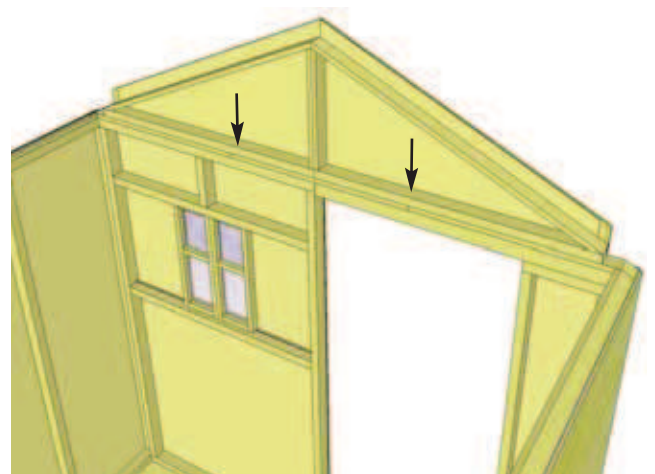
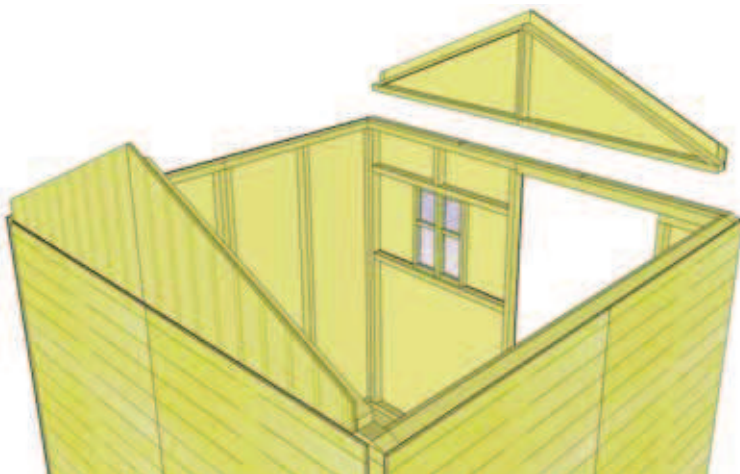

34. Complete positioning and attachment of front gable as per **Step 32-33**.

C. Rafter and Roof Section

Exploded view of all parts necessary to complete the Roof Section.
Identify all parts prior to starting. (Roof Filler Shingles Missing)

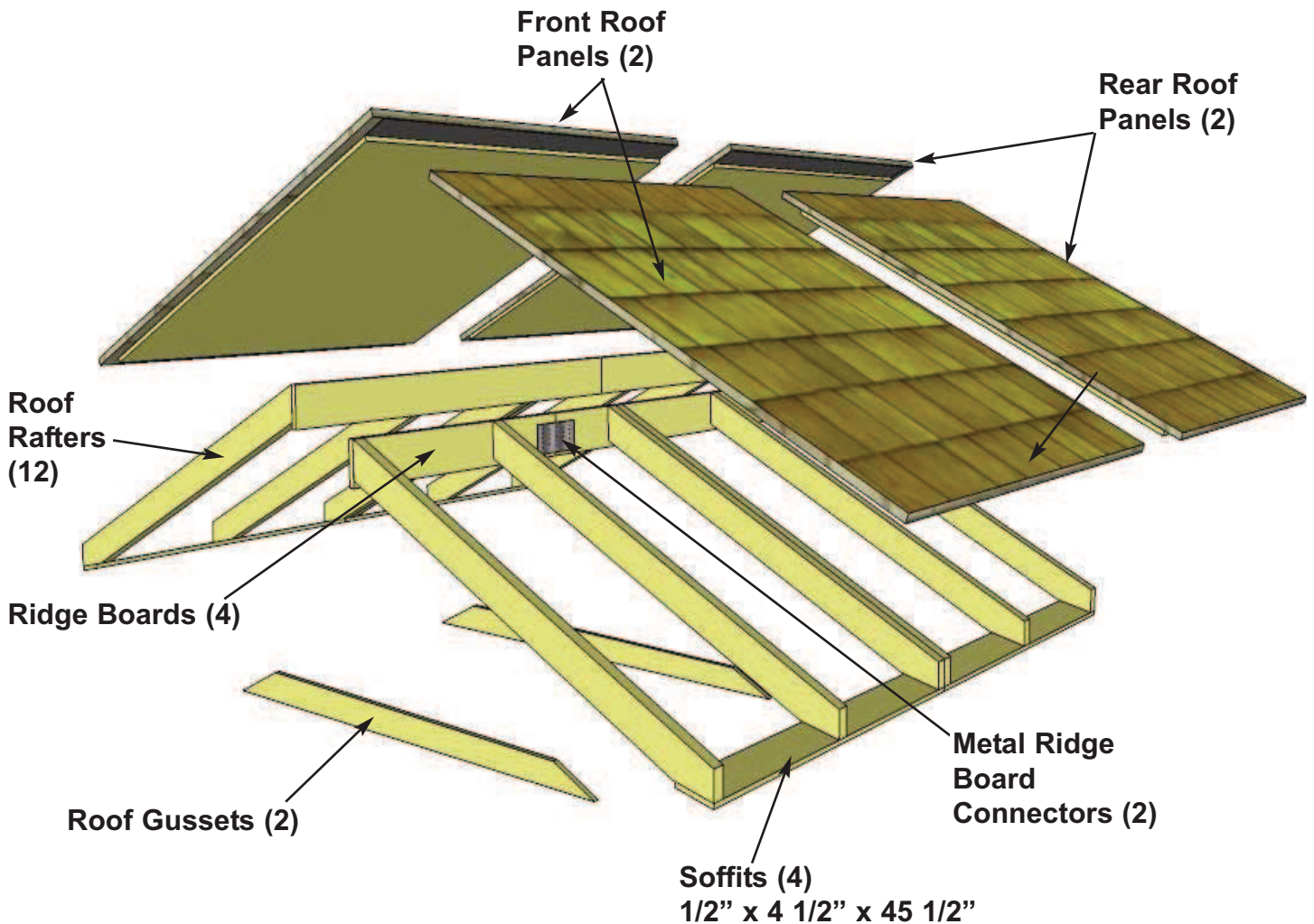

3/4" thick
Ridge Board

8 - 3/4" screws

35. Locate 3/4" x 4 1/2" x 57 1/2" & 33 1/2" Ridge Boards and attach together with **Metal Ridge Board Connector** using 8 - 3/4" screws. Total Length when connected is 91". Complete two Sets. Position Metal Ridge Board Connector evenly on Ridge Boards.

36. Locate 6 - 1 1/2" x 3 1/2" x 56 1/2" long **Rafters**, 2 - 1/2" x 4 1/2" x 45 1/2" long **Soffits** and completed Ridge Board from **Step 35**. Lay out as illustrated on a flat level surface.

Important: Pilot Hole Ridge Board to prevent splitting!

Important: Pilot Hole Soffit to prevent splitting!

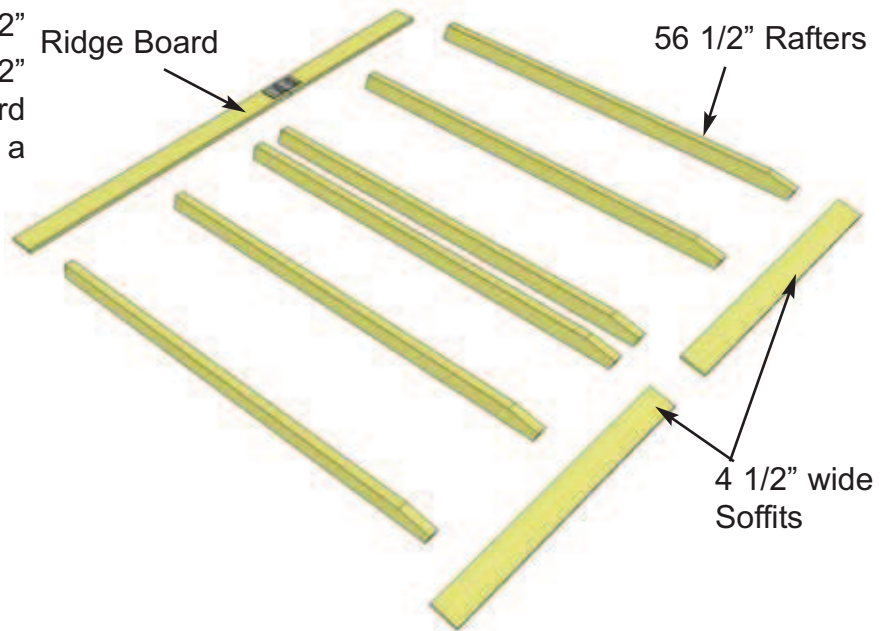

37. Attach end of a 45 1/2" long Soffit Board flush to ends of outside rafter with 2 - 1 1/4" screws per rafter end. **Drill pilot hole in Soffit ends to prevent splitting.** Attach Ridge Board to opposite rafter end aligning to bottom of rafter with 2 - 2" screws. Center Soffit on Doubled-up Rafters and secure with 2 - 2" screws. Measure 45 1/2" from outside rafter and secure Ridge Board to rafter with 2 - 2" screws. Attach Doubled-up Rafters together with 3 - 2 1/2" screws.

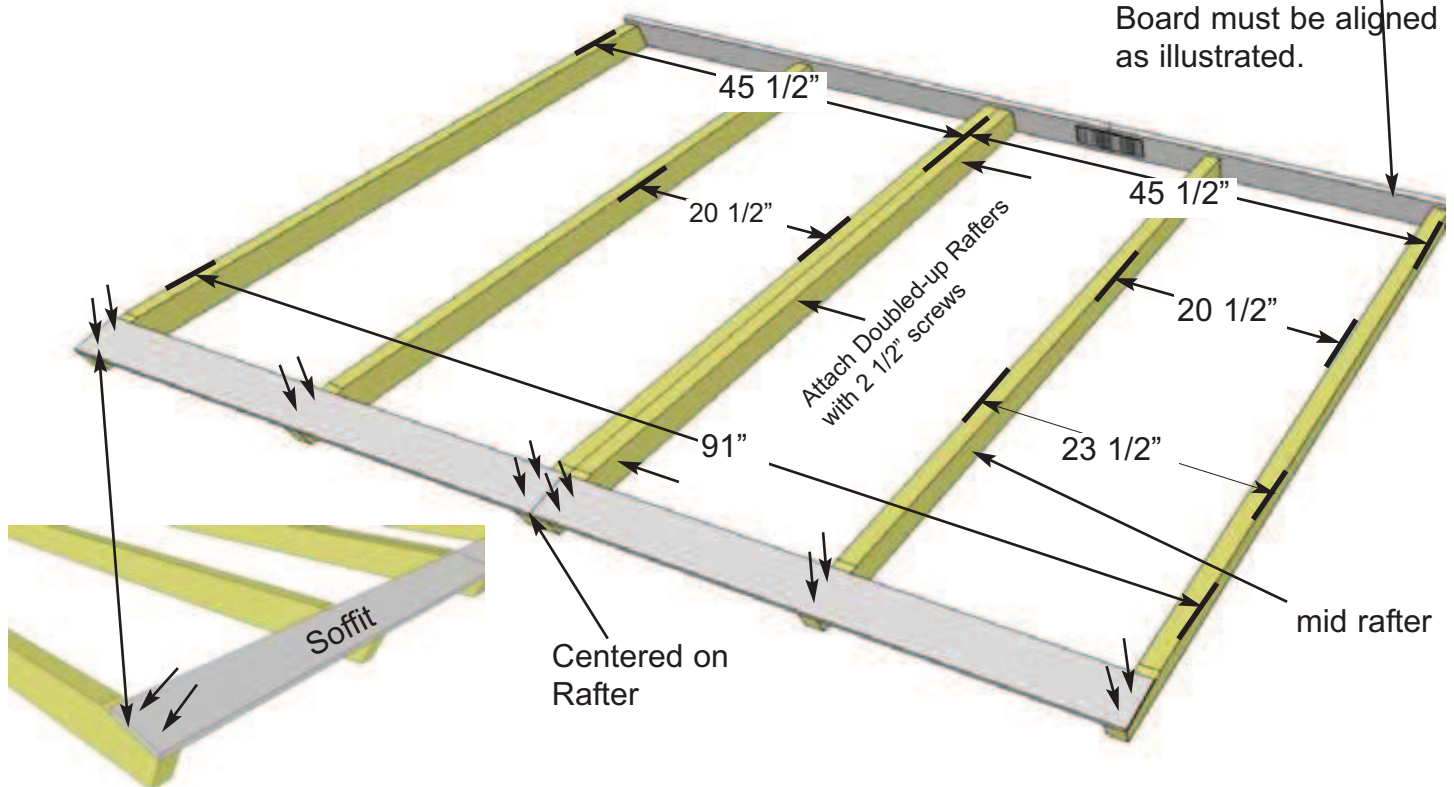
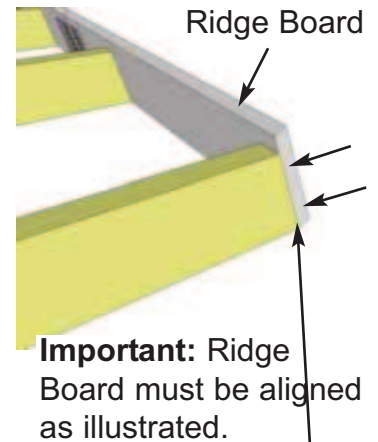

38. Measure, position and attach mid rafters as illustrated above as per **Step 36**.

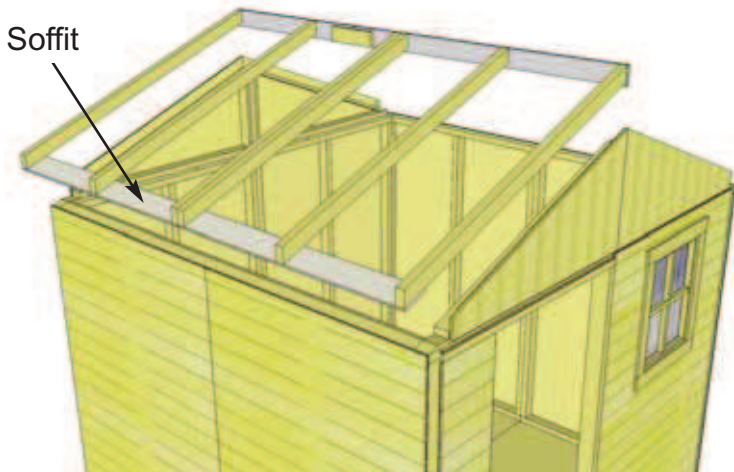

39. Flip Rafter Section over so Soffit is facing down. Starting with the left side, lift completed rafter section up and place on gable framing.

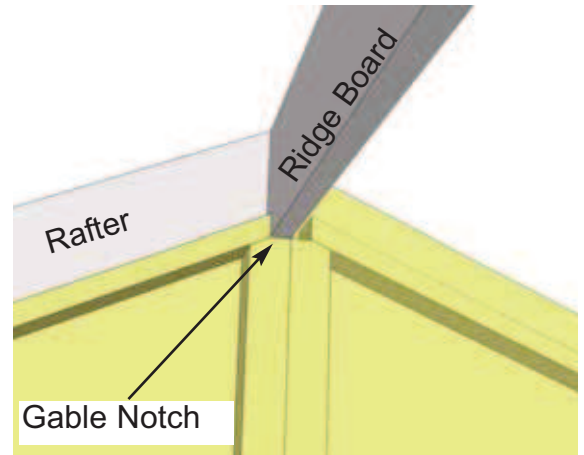

40. Slide Rafter Section up on gable framing until bottom of Ridge Board slips into gable notch.

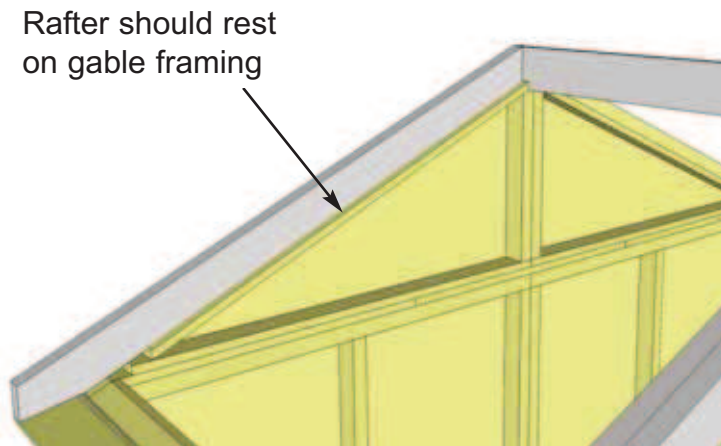

41. When Rafter Section is correctly positioned, outside rafters will sit equally on gable framing and Soffit will sit approximately 1/8" away from wall panels.

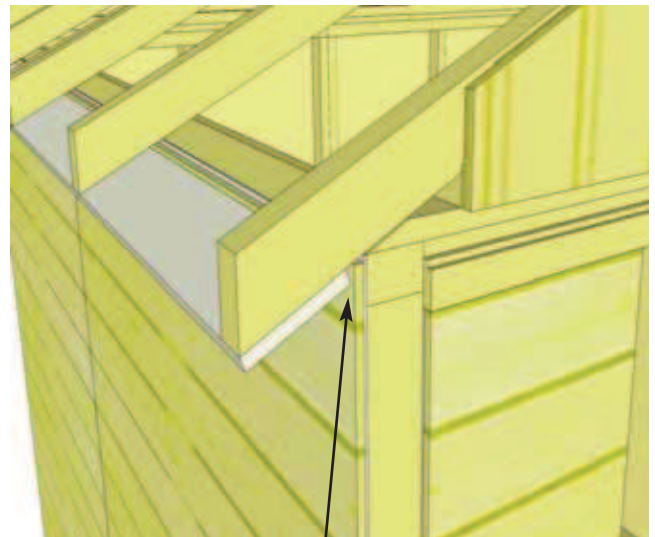

Soffit should sit approx. 1/8" away from wall panel.

Completed left side Rafters

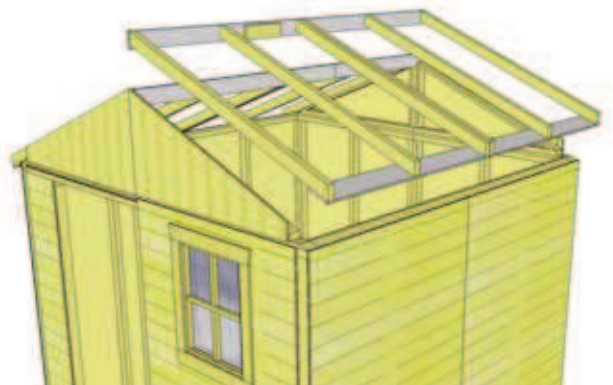
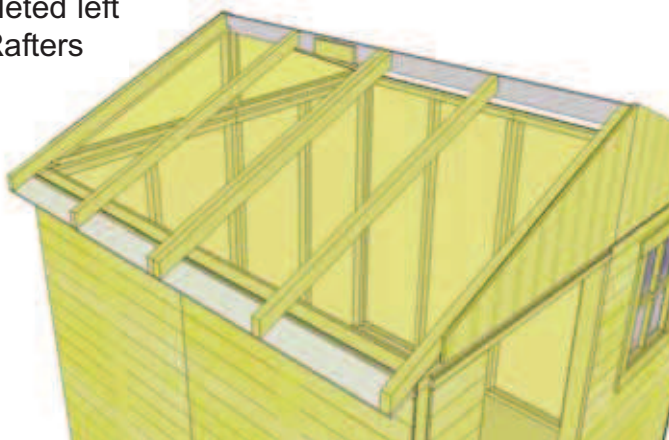

42. Place 2nd completed Rafter Section on gable wall framing. Position as per **Steps 39 & 40.**

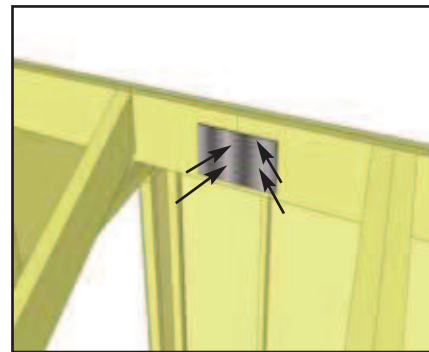
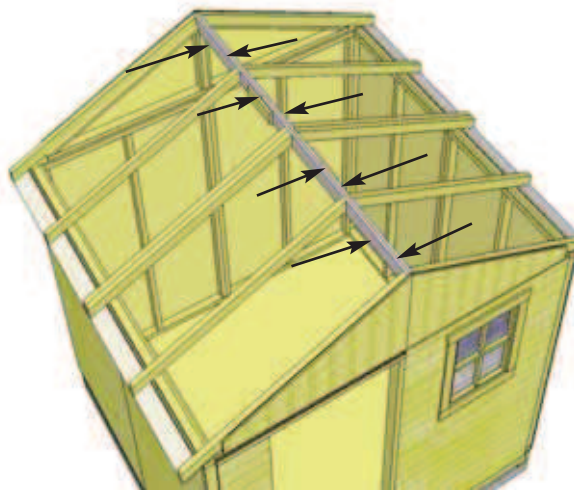
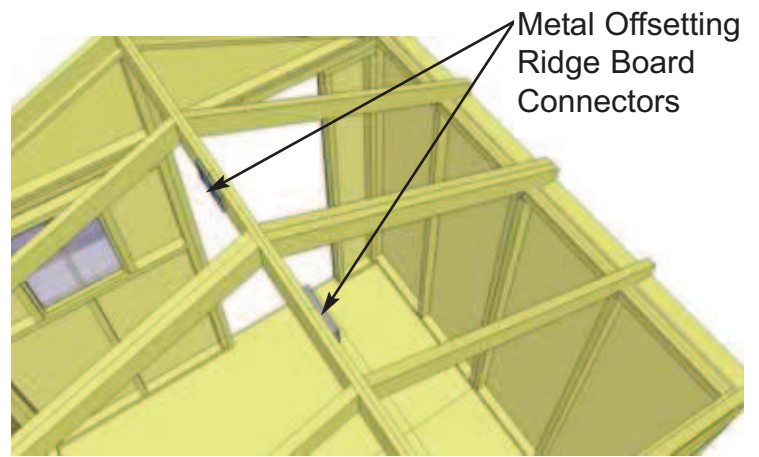
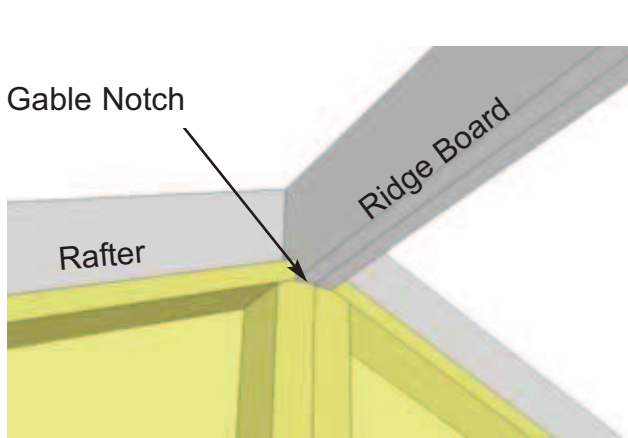

43. At the peak, align Ridge Boards so they are flush together and secure them with 8 - 1 1/4" screws. To completely secure Ridge Boards, place 4 - 1 1/4" screws into any of the remaining Metal Ridge Board Connector holes. Complete both sides. **Important:** if there is a gap between Ridge Boards, try pushing side walls closer together from outside. Walls should be 91" apart at top from inside of wall plate to wall plate.

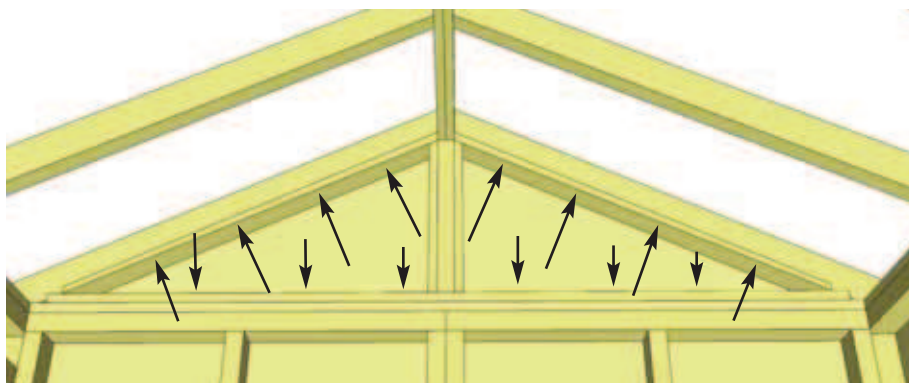

44. With both Ridge Boards connected, completely secure Gable framing to walls and rafters. Use 4 - 2" screws per Rafter. Use an additional 6 - 2" screws to secure Gable to wall. **Note: you may have to remove the 2 temporary screws in Gable from Step 33 and reposition Gable for best fit prior to completing gable attachment.**

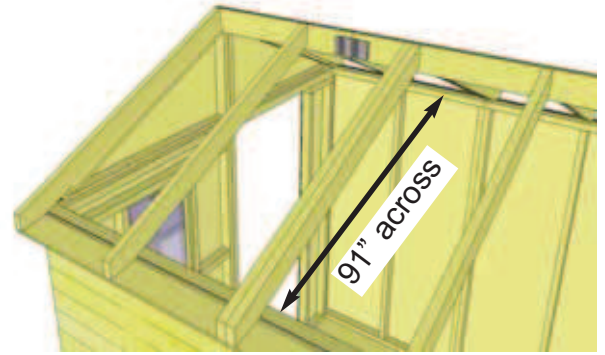
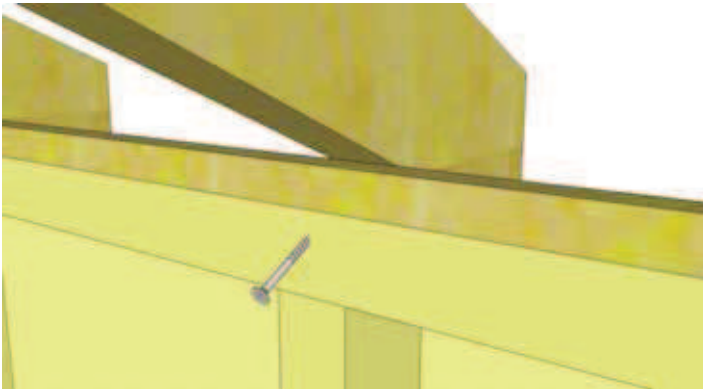

45. Secure Rafters to Top Wall Framing with one 3" screw per rafter. Screw through Wall Frame at an angle. Have two helpers push the side walls at the top from the outside of shed until inside to inside measurement between the side plates is 91".

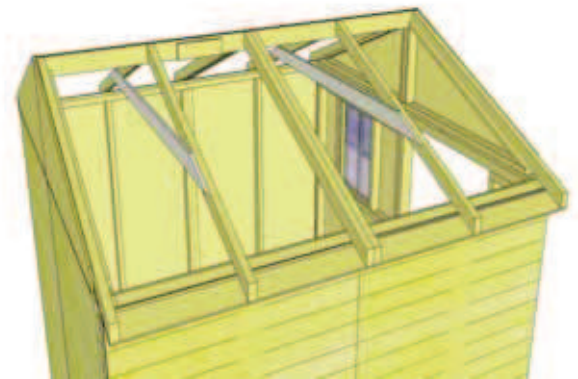
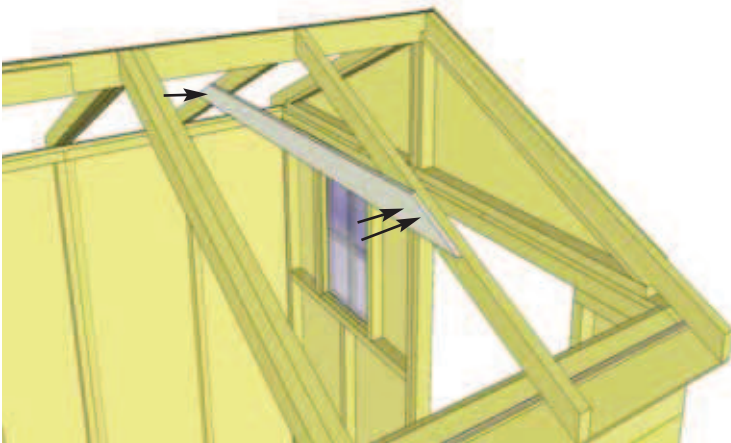

46. Roof Gussets are positioned on both mid rafters. Slide gusset up, use level to square gusset and attach to rafters with 4 - 2" screws. Pilot hole each Gusset end with 1/8" drill bit. Complete remaining Gusset.

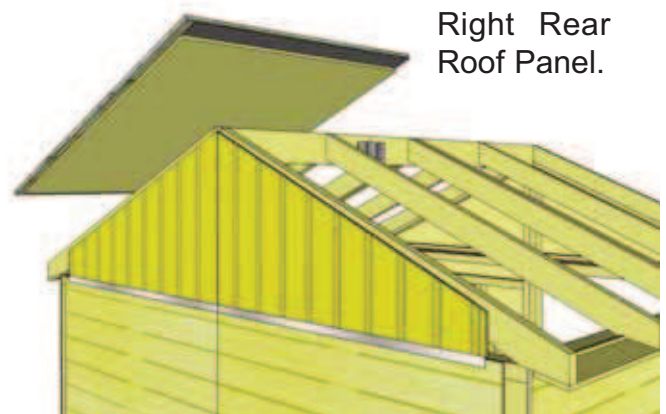
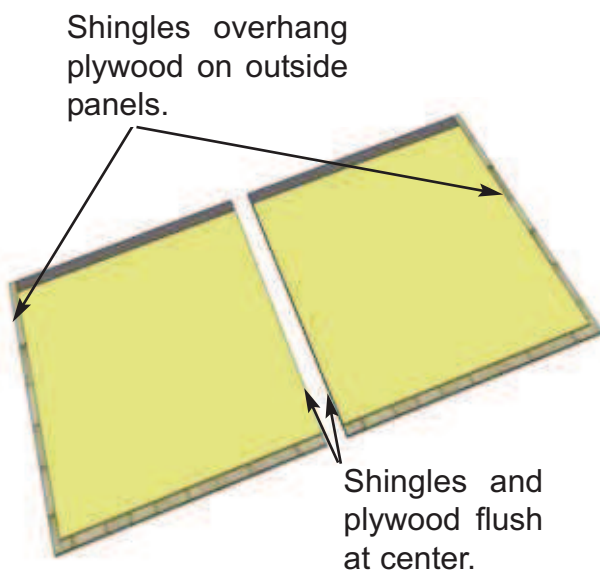

47. Identify Roof Panels. There are 2 Rear and 2 Front Roof Panels. Starting with a **Right Rear Roof Panel**, lift up and place on rafters.

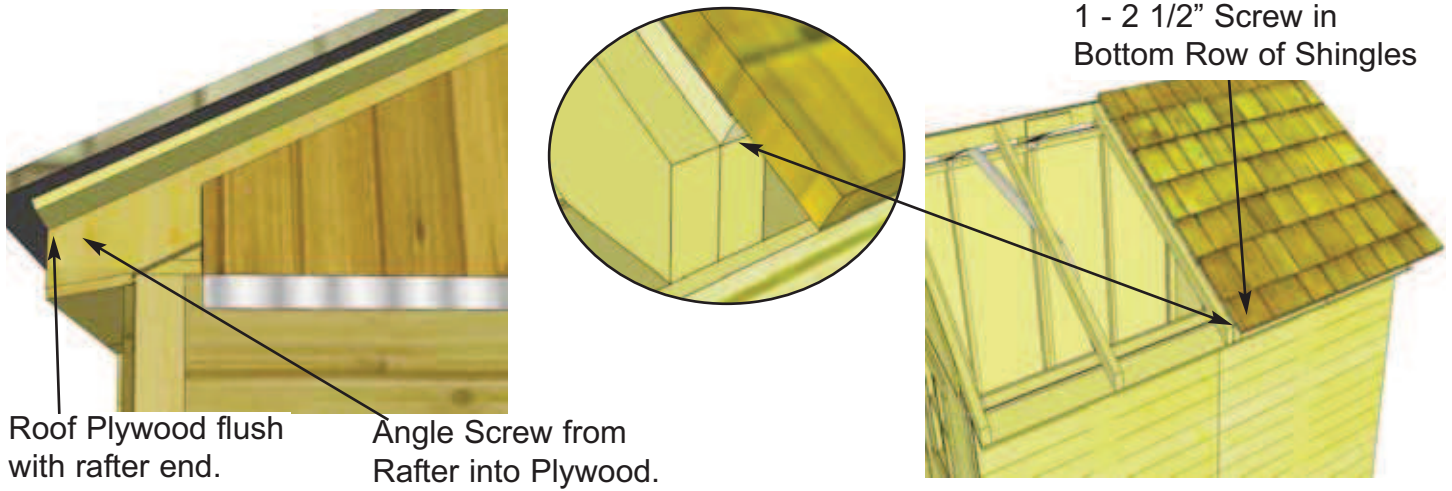

48. Place Roof Panel so it sits flush on 3rd rafter from the outside (doubled up rafter). Plywood on roof should be flush with end of rafter at bottom. From the outside, screw down through bottom row of shingles into rafter with 1 - 2 1/2" screw. Angle a 2 1/2" screw from outside rafter into roof plywood.

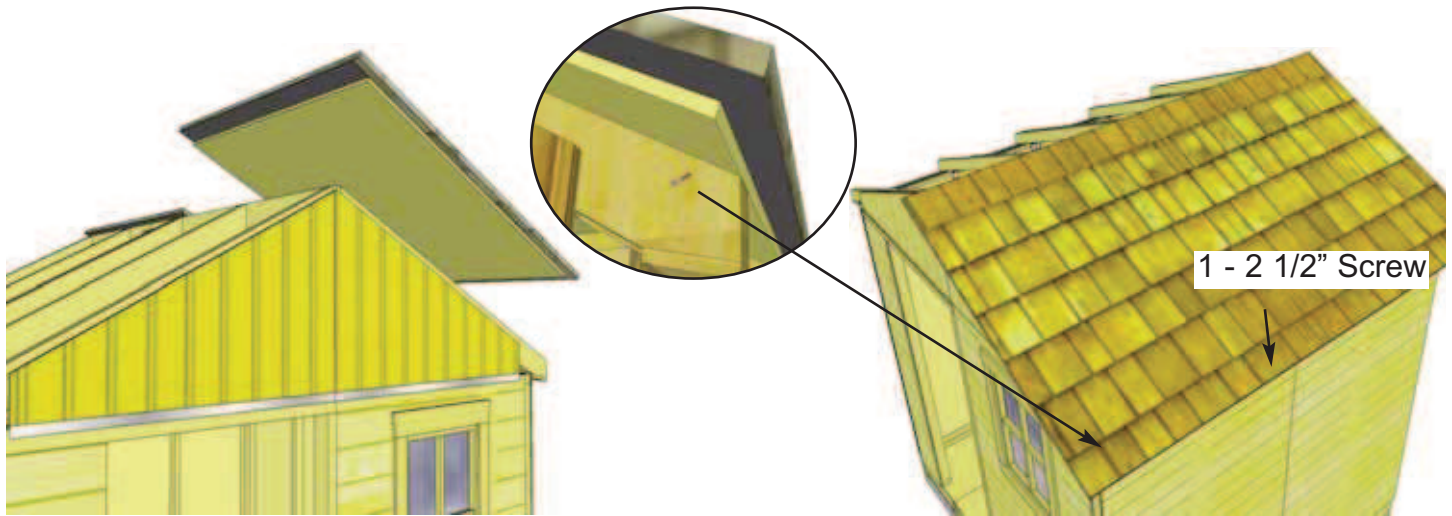

49. Locate **Right Front Roof Panel** (roof plywood flush with shingles on inside, shingles overhanging plywood on outside) and place on rafters. Align panels as per **Step 48** and screw panel down to rafter with 1 - 2 1/2" screw in the bottom row of shingles. Angle a 2 1/2" screw from outside rafter into roof plywood.

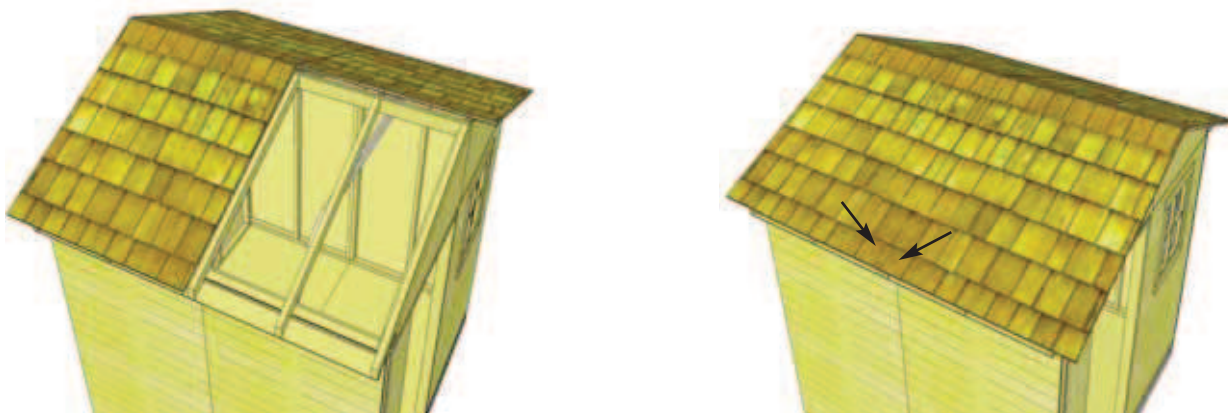

50. Position and attach Left Side Roof Panels as per **Steps 47-49**.



51. Roof **Filler Shingles** are included to cover roof seams. Starting at the bottom, slide the first Long shingle in until flush with other bottom shingles.

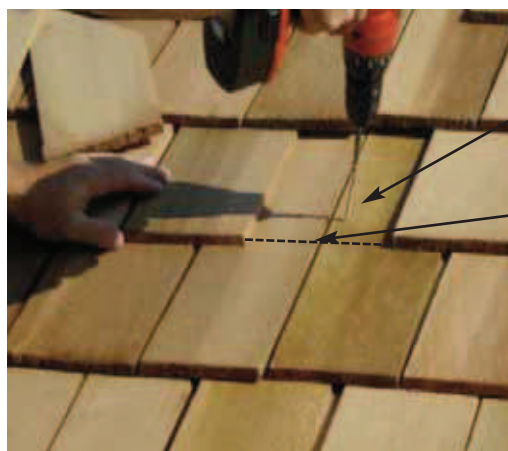

Attach above the exposure line.

Exposure Line

52. Screw first filler shingle down to rafters using 1 - 2 1/2" screw per panel (2 in total). Make sure to screw into both rafters.



53. Slide in another Long Filler Shingle and attach as per **Step 52**. On your last row of shingles, the filler shingle is precut to fit properly. Attach to roof with 2 Shingle Nails per shingle.

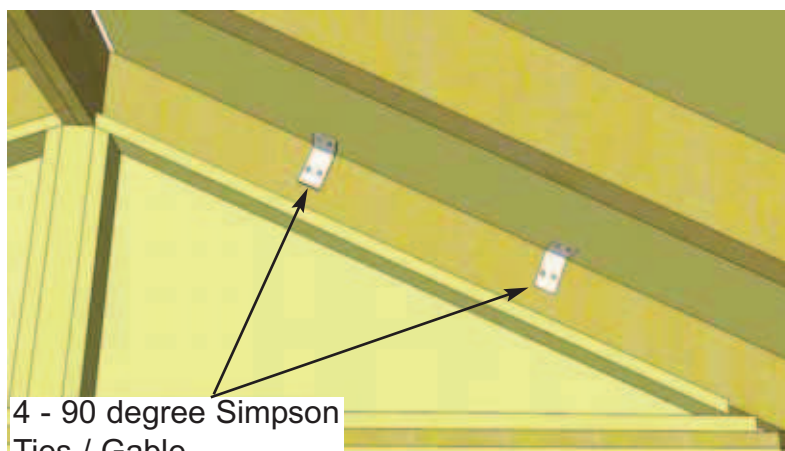

4 - 90 degree Simpson Ties / Gable.

54. Position 2 Simpson Strong ties on plywood and outside rafters and secure with 4 - 1 1/4" screws. There are 8 ties in total, 4 per Gable.

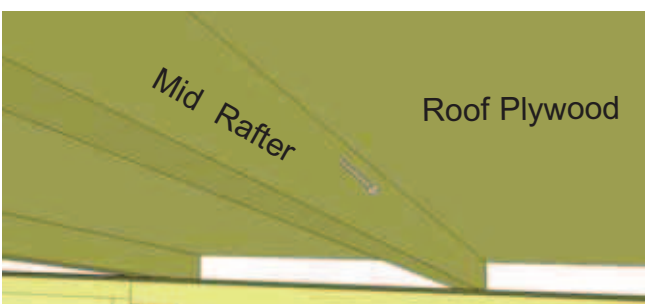

Mid Rafter

Roof Plywood

3 - 2 1/2" angle screwed into each mid rafter.

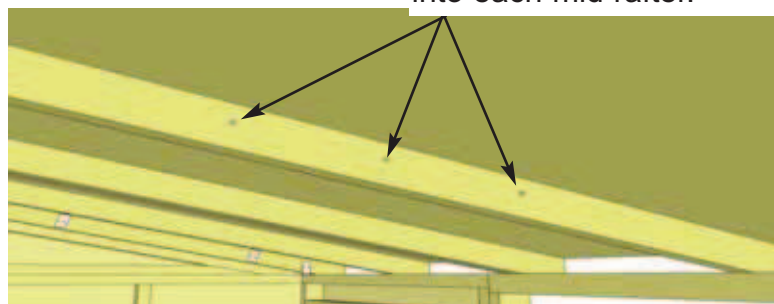

55. To further secure roof panels, from the inside, drill 1/8" pilot holes in each mid rafter (3 per rafter) on an angle. Using 3 - 2 1/2" screws, secure rafters to roof plywood. **Note:** from outside, have a helper push roof panel down so plywood sits flush against rafter when securing.

D. Miscellaneous Section

Exploded view of all parts necessary to complete the Miscellaneous Section. Identify all parts prior to starting.

Note: missing from exploded drawing: Interior Door Stops.

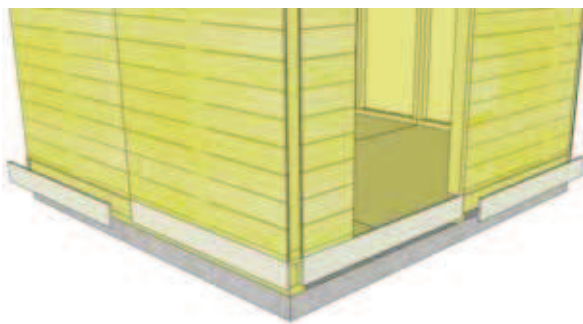
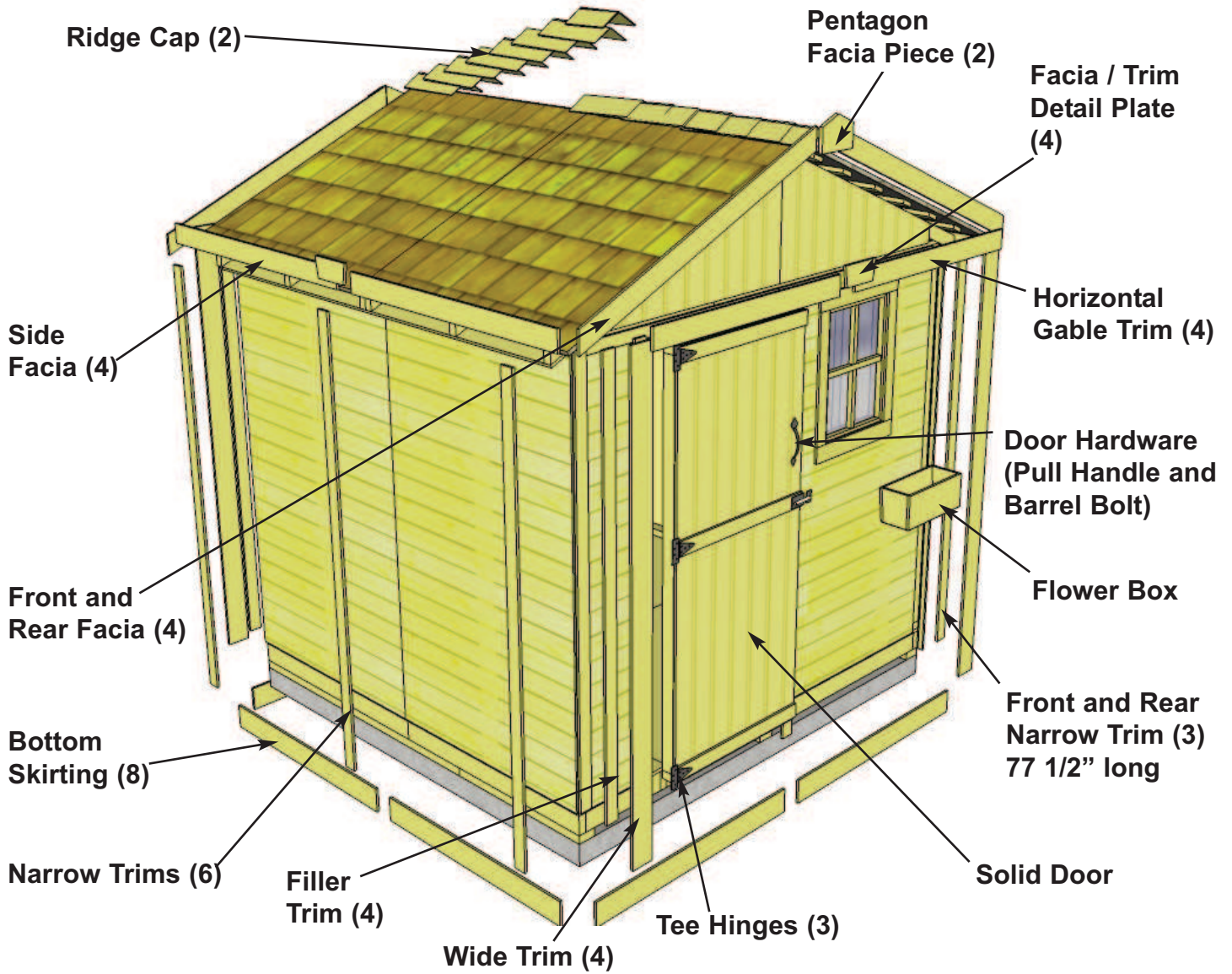

2 pieces of Bottom Skirting for front and rear. 2 pieces for sides.

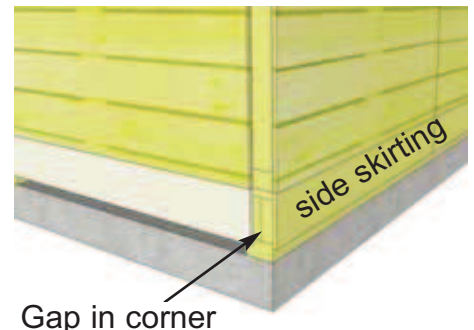

56. Attach **Bottom Skirting** around the base of the shed. Skirting will hide floor framing. The side skirting pieces will meet together in the center. Gaps on outside will be covered by Wide Trim pieces later. Start with front and rear skirting pieces first and attach with 4 - 1 1/2" finishing nails per piece.

Expert Advice: When installing trim, sort pieces according to color and pieces that are most pleasing to the eye. Start with least visible side and use the least desirable pieces first. Install trim to most visible sides as your skill installing trim improves.

57. Attach **Filler Trim** (4 - 1/2" x 2 1/2" x 75") to front and rear walls in each corner. Hammer with 8 - 1 1/2" finishing nails. Strips are positioned flush with siding and bottom skirting.

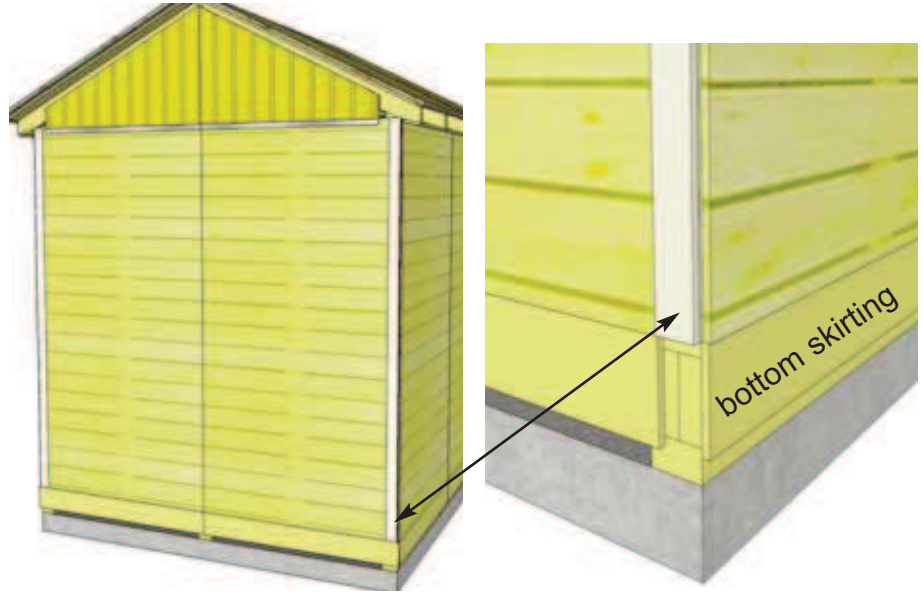

58. Align and attach both **Narrow and Wide Trims** in each corner. Starting with a Narrow Trim (1/2" x 2 1/2" x 79" long), align tight underneath Soffit and Rafter. Position flush with Filler Trim so Wide Trim will cap it when attached in **Step 59**. Use 8 - 1 1/2" finishing nails to secure. Note that Narrow Trim will sit slightly below Bottom Skirting when correctly aligned.

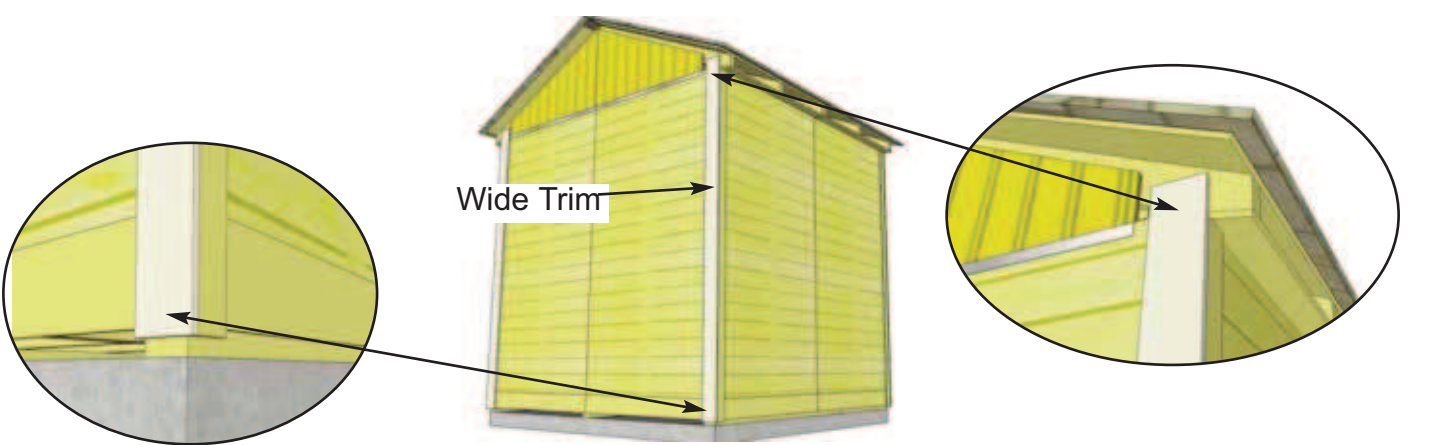

59. Position **Wide Trim** (1/2" x 4 1/2" x 82") over Filler Trim and to cap Narrow Trim. Align Wide Trim at bottom with Narrow Trim so flush with each other. Secure trim with 8 - 1 1/2" finishing nails. Complete remaining corner trims.

60. Attach **Narrow Rear Wall Trim** (1 - 1/2" x 2 1/2" x 77 1/2"), where rear wall panels come together and leave a seam, with 8 - 1 1/2" finishing nails. Align Trim at bottom with the corner trims.

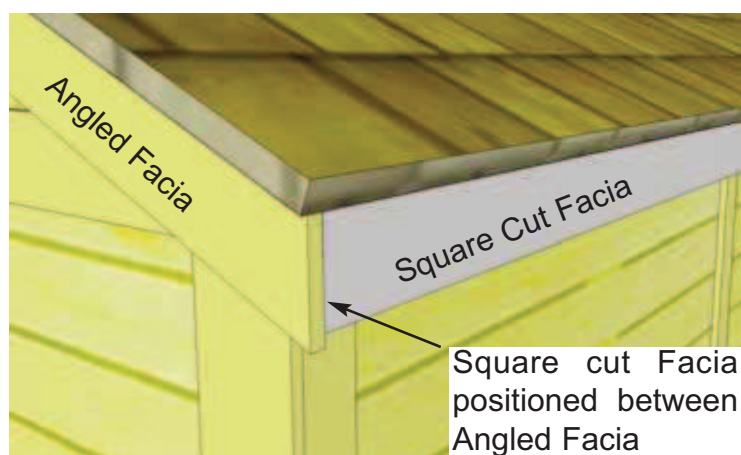
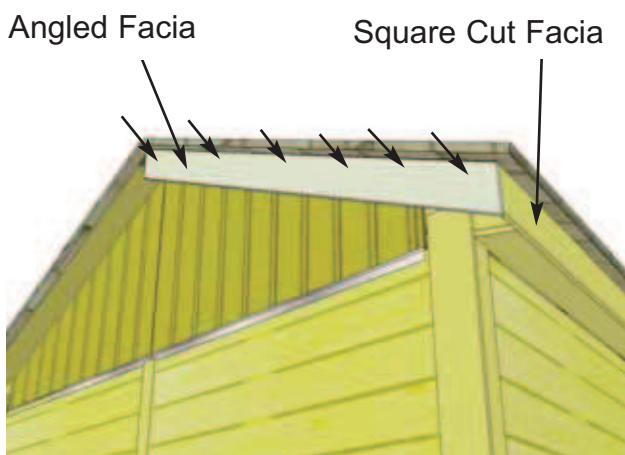

61. Position **Front and Rear Fascia** (angle cut on ends) and **Side Fascia** (square cut on ends) in corner. Line Fascia up so square cut Fascia is positioned between angled cut fascia. Attach angled fascia to plywood end with 6 - 1 1/2" finishing nails per piece. Gap where fascia boards come together at peak will be covered in **Step 63**. Do a dry run using Fascia to help you correctly position before attaching.

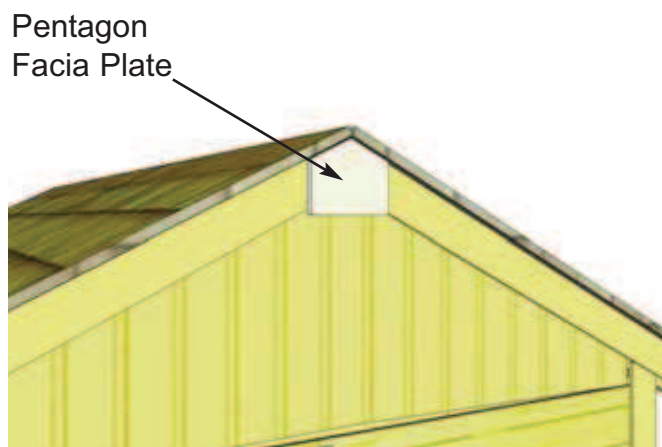
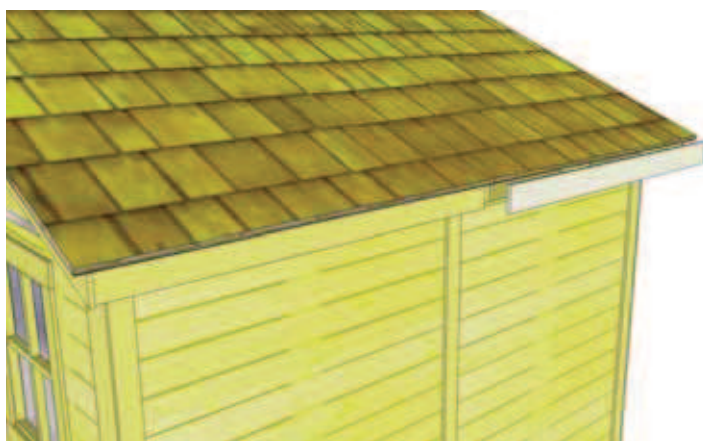

62. Attach **Side Fascia** to roof rafter ends. There are 2 Fascia pieces per side. Secure with 6 - 1 1/2" finishing nails per piece.

63. Attach **Pentagon Fascia Plate** where Front and Rear Fascia meet at the peak. Use 4 - 1 1/2" finishing nails per piece to secure.

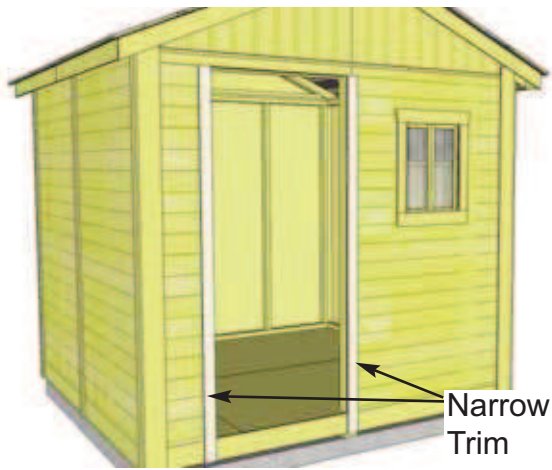

64. Position the 2 remaining **Narrow Trim** (2 - 1/2" x 2 1/2" x 77 1/2") pieces flush with inside of door jamb. To determine vertical height of trim, do a dry run with Horizontal Gable Trim in **Step 65**. Make sure Gable Trim covers flashing and mark. Attach Trim with 8 - 1 1/2" finishing nails.

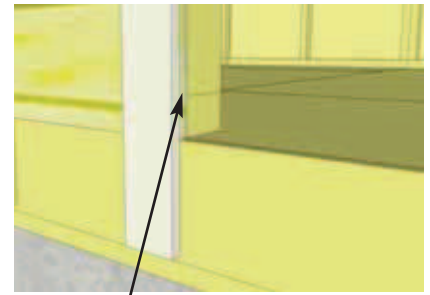

Flush with inside of Door Jamb.

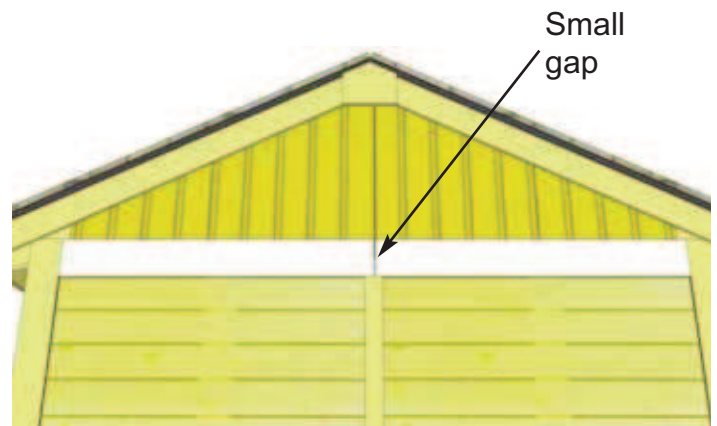
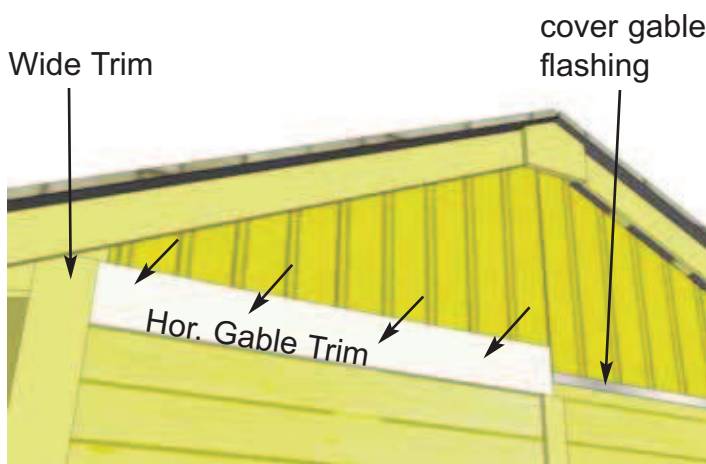

65. Attach **Horizontal Gable Trim** (4 - 1/2" x 4 1/2" x 44 1/2") to Front and Rear of shed. Position so flush with top and edge of wide trim. Use 4 - 1 1/2" finishing nails per piece to secure (2 pieces per side).

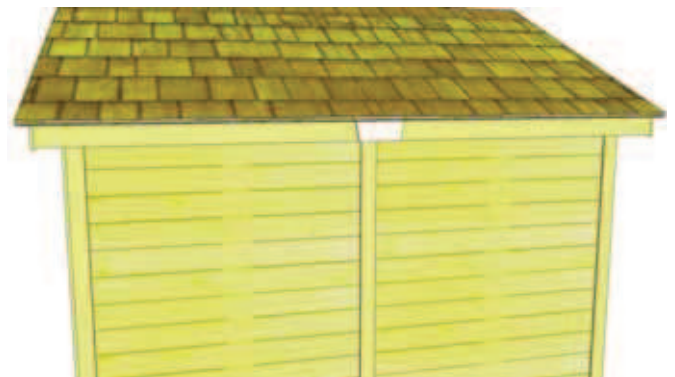

66. Attach **Horizontal Gable Trim Detail and Facia Trim Detail Plates** to cover seams where facia and horizontal trim pieces come together. Horizontal Gable Trim Detail Plates are 4 1/2" high while Facia Trim Detail Plates are 3 1/2" high. Secure each with 4 - 1 1/2" finishing nails per piece.

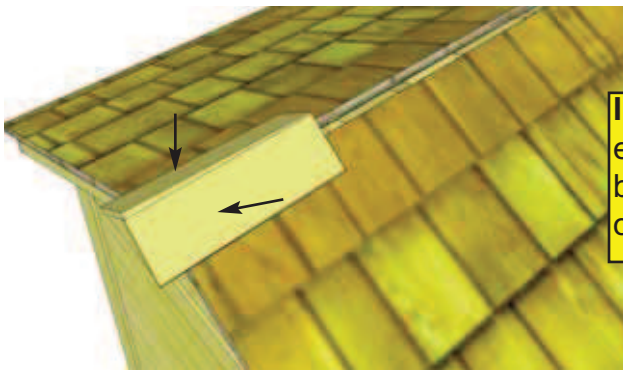

Important: Butt (thick) end of Ridge Cap will be facing towards the outside of shed.

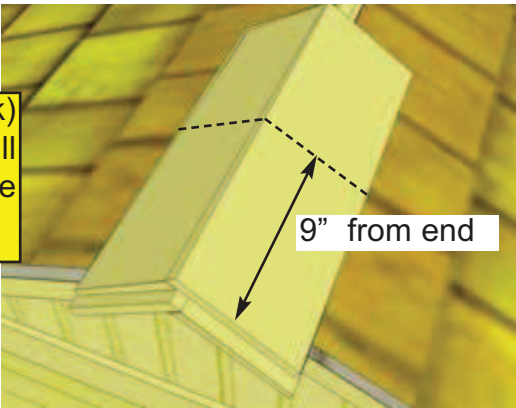

67. Place First Roof Ridge Cap on roof peak overhanging shingles by approximately 2". Attach with 2- 1 1/4" Shingle Nails 9" from end. Place 2nd Ridge Cap 1" back from 1st cap. Attach with 2- 1 1/4" Shingle Nails 9" from end.

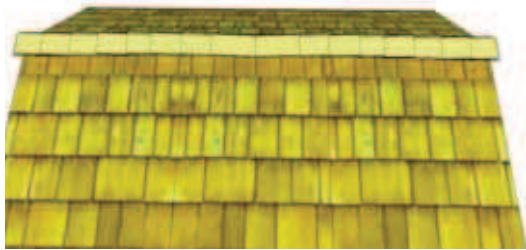
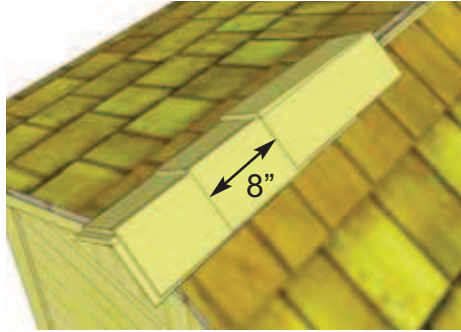
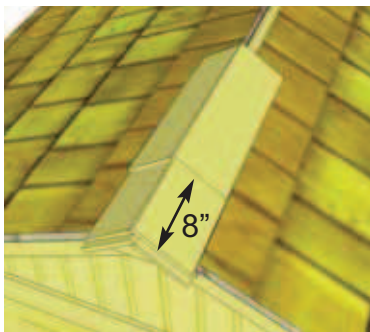

68. Place 3rd Ridge Cap 8" back from 2nd (enough to cover shingle nails). Attach 3rd Ridge Cap down as per **Step 67**. Continue to position and attach Ridge Caps until half roof is complete. From opposite side, position and attach Ridge Caps as described above. Score/cut 1 Ridge Cap to 12" or to fit in the center of roof. Attach center cap with 4 - 1 1/4" Shingle Nails.

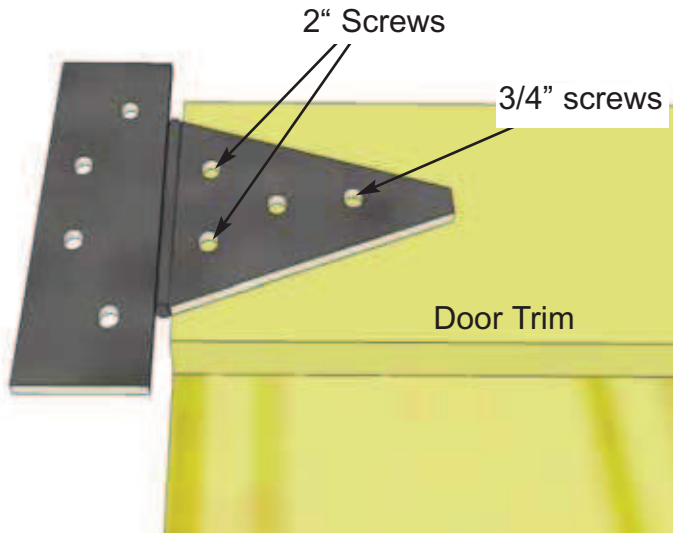
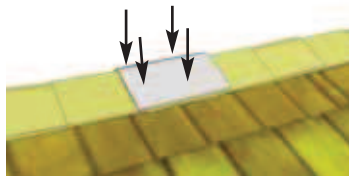

69. Attach **Door Hinges** to **Door Panel**. At this stage, door can swing open on the left or right. Decide on your preference and attach hinges to door. (3 hinges per door centered on door trim.) Use 3/4" and 2" long black screws on hinge / door attachment as illustrated above.

3/8" gap at bottom. Evenly spaced on sides.

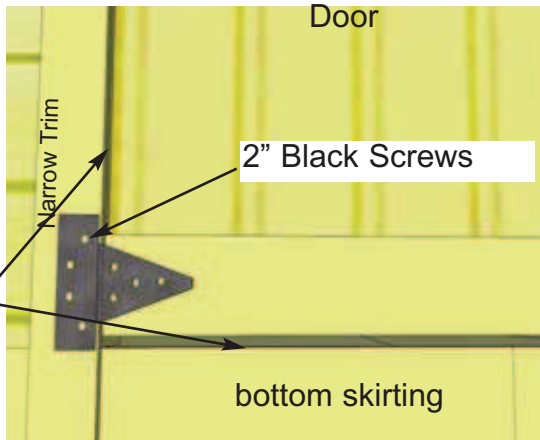

70. Place Door panel into position, gap 3/8" on bottom and evenly spaced on sides and attach hinges to Narrow Trim with 1 1/2" black screws. Use shim to help keep the door evenly spaced on bottom. See **Step 71** for gap at top.

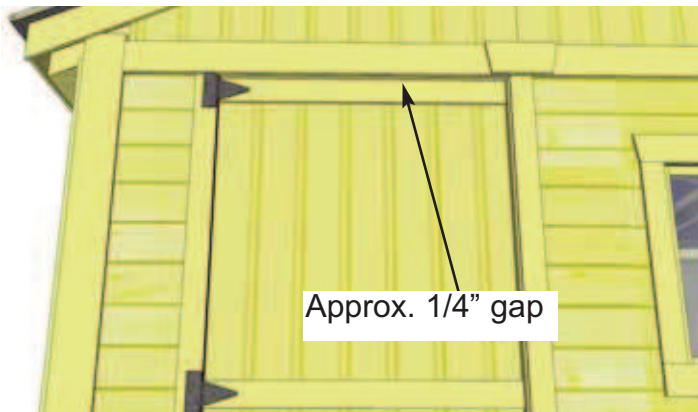

71. Door Panel should be positioned so there is 1/4" gap at top. Use a shim once again to help you position door correctly. Attach top and middle hinge to narrow trim with hinge hardware provided.



73. Attach Interior **Door Stops** to door framing from inside of shed. Start with Horizontal piece first. Use 4 - 2" screws to secure each Stop. Stops should overlap door by approx. 1/2".

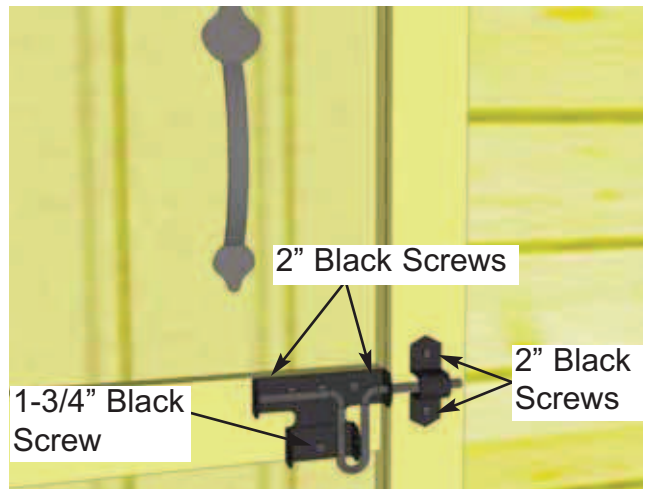

72. Attach **Black Barrel Bolt** as illustrated above with 2" & 3/4" Black Screws. Note how female part of Barrel Bolt is positioned higher than male. Do a dry run first to position Barrel Bolt correctly. **Important:** Drill pilot holes with 1/8" drill bit prior to securing with screws to prevent wood splitting. On 3/4" screw, drill shallow pilot hole only.

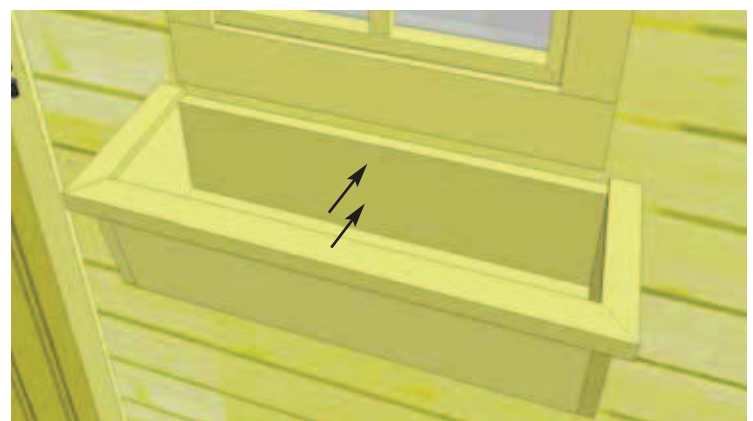
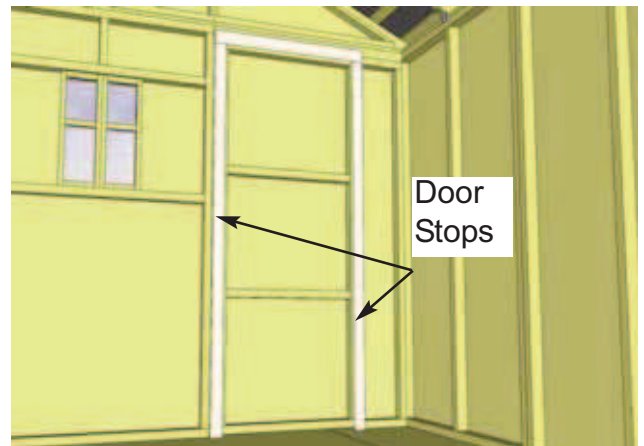

74. Assemble **Flower Box** with Assembly Instructions included. Position completed Flower Box below bottom of window trim and secure with 2 - 2" screws. Screw from inside of box into the center wall stud. Attach second screw 2" underneath first screw and once again into the wall stud.



Congratulations on building your 8x8 Gardener's Shed!

Note: Our Sheds are shipped as unfinished products. If exposed to the elements, the western red cedar lumber will weather to a silvery-gray color. If you prefer to keep the cedar lumber looking closer to the original color, we suggest that you treat the wood with a good oil base wood stain. You may also wish to paint your new shed rather than stain it. In both cases we recommend that you consult with a paint and stain dealer in your area for their recommendations.



We hope your experience assembling your 8x8 Gardener's Shed has been both positive and rewarding.

We value your feedback and would like to hear back from you on how well we are doing in the following areas:

1. Customer Service
2. On Time Shipping
3. Motor Freight Delivery
4. Quality of Materials
5. Assembly Manual
6. Overall Satisfaction.

Please call, write or email us at:

Outdoor Living Today

Canadian Address
9393 287th Street
Maple Ridge, British Columbia
Canada V2W 1L1

United States Address
P.O. Box 96
Sumas, Washington
USA 98295



The materials contained in this Assembly Manual may be downloaded or copied provided that ALL copies retain the copyright and any other proprietary notices contained on the materials. No material may be modified, edited or taken out of context such that its use creates a false or misleading statement or impression as to the positions, statements or actions.