



# 12x12 SunShed Garden Shed

Revision #17  
August 18th, 2015



Thank you for purchasing an 12x12 SunShed Garden Shed from Outdoor Living Today. Please take the time to identify all the parts prior to assembly.

### Safety Points and Other Considerations

Our products are built for use based on proper installation and normal residential use, on level ground. Please follow the instruction manual when building your shed and retain the manual for future maintenance purposes.

Some of the safety and usage measures you may wish to consider include:

- snow load ratings vary by geographical location. If heavy or wet snowfall occurs, it is advisable to sweep the snow off the roof(s).
- if the product is elevated, any structural and building code requirements are solely the customer's responsibility, and should be abided by.
- in high or gusty wind conditions it is advisable to keep the structure securely grounded.
- have a regular maintenance plan to ensure screws, doors, windows and parts are tight.

Customer agrees to hold Outdoor Living Today free of any liability for improper installation, maintenance and repair of any of our products.

**In the event of a missing or broken piece, simply call the Outdoor Living Today Customer Support Line @ 1-888-658-1658 within 30 days of the delivery of your purchase. It is our commitment to you to courier replacement parts, free of charge, within 10 business days of this notification. Replacement parts will not be provided free of charge after the 30 day grace period.**

**Thank you for purchasing our 12x12 Sunshed Garden Shed.  
Please take the time to identify all the parts prior to assembly.**

**A. Floor Section**

- 3 - 45 1/2" x 75" - Floor Joist Frames (Interior Joist Unattached)
- 3 - 45 1/2" x 66 1/2" - Floor Joist Frames (Interior Joists Unattached)
- 6 - 1 1/2" x 3 1/2" x 72" - Floor Joists
- 6 - 1 1/2" x 3 1/2" x 63 1/2" - Floor Joists
- 3 - 45 1/2" x 75" - Floor Plywood
- 3 - 45 1/2" x 66 1/2" - Floor Plywood
- 10- 1 1/2" x 3 1/2" x 76 1/2 & 60" - Floor Runners

**B. Wall Section**

**Main Wall Panels**

- 4 - 45 1/2" x 75" - Solid Wall Panels
- 4 - 45 1/2" x 75" - Window Wall Panels
- 3 - 45 1/2" x 75" - Double Window Walls
- 1 - 12" x 73" - Narrow Wall Panel
- 2 - 45 1/2" x 9" - Wall Extensors
- 2 - 46 1/4" x 9" - Angled Left Wall Extensors
- 2 - 46 1/4" x 9" - Angled Right Wall Extensors

**Window Inserts**

- 6 Fixed Windows (sides)
- 4 Functional Windows

**Door, Door Jamb, Header & Door Stops**

- 1 - 1 1/2" x 3" x 73" - Vertical Door Jamb
- 1 - 2" x 3" x 45 1/2" - Door Header (Dado)
- 2 - 1/2" x 2 1/2" x 72" - Interior Vertical Door Stops
- 1 - 1/2" x 2 1/2" x 36" - Interior Horizontal Door Stop
- 1 - 31 1/2" x 72" - Dutch Door - 2pcs (42" and 30" high)

**Gable Walls**

- 2 - Left Hand Gables- Triangular shaped
- 2 - Right Hand Gables- Triangular shaped

**Top Wall Plates**

- 4 - 3/4" x 2 1/4" x 65 3/4" - Sides- 22 1/2 degree cut on edge
- 4 - 3/4" x 2 1/2" x 70 3/4" - Front and Rear - Angled on end

**C. Rafter Section**

- 18 - 1 1/2" x 3 1/2" x 81 1/8" - Rafters - angled on both ends
- 2 - 3/4" x 4 1/2" x 52 1/2" - Ridge Boards
- 2 - 3/4" x 4 1/2" x 84" - Ridge Boards
- 4 - 1/2" x 4 1/2" x 68 1/4" - Soffits
- 2 - 3/4" x 3 1/2" x 56 1/2" - Support Beam
- 2 - 3/4" x 3 1/2" x 75" - Support Beam
- 10 - 5/8" x 6" x 6" - Plywood Support Beam Connector Plates
- 3 - 3/4" x 3 1/2" x 72" - Gussets (angle cut on both ends)

**D. Roof Section**

- 1 - Left Side - Shingle Overhanging Battens (Long)
- 1 - Right Side - Shingle Overhanging Battens (Long)
- 1 - Center - Shingles flush with Battens (Long)
- 1 - Left Side - Shingle Overhanging Battens (Short)
- 1 - Right Side - Shingle Overhanging Battens (Short)
- 1 - Center - Shingles flush with Battens (Short)

- 12 - 3/4" x 3/4" x 48" - Polygal Support Cleats
- 3 - 1/2" x 2 1/2" x 44" - Mid Ridge Caps for Polygal
- 2 - 1/2" x 5 1/2" x 44" - Outside Ridge Caps for Polygal
- 2 - 1/2" x 3 1/2" x 44" - Center Ridge Caps for Polygal
- 6 - 20 1/4" x 48" - Polygal Panels

**E. Miscellaneous Section**

**Bottom Skirting**

- 12 - 1/2" x 4 1/2" x 45 1/4" - Bottom Skirting

**Corner & Wall Trim**

- 4 - 1/2" x 2 1/2" x 75" - Filler Trim
- 4 - 1/2" x 4 1/2" x 82" - Vertical Corner Trim
- 5 - 1/2" x 2 1/2" x 87" - Vertical Trim
- 8 - 1/2" x 2 1/2" x 79" - Vertical Trim
- 2 - 1/2" x 4 1/2" x 58 1/2" - Horizontal Gable Trim (Left) -angled
- 2 - 1/2" x 4 1/2" x 58 1/2" - Horizontal Gable Trim (Right) -angled
- 1 - 1/2" x 2 1/2" x 32" - Horizontal Door Trim (above Door)
- 1 - 1/2" x 2 1/2" x 8" - Horizontal Narrow Wall Trim (above Wall)

**Facia Trim**

- 2 - 3/4" x 3 1/2" x 82 1/8" - Angle Cut Front/Rear Facia Trim (L)
- 2 - 3/4" x 3 1/2" x 82 1/8" - Angle Cut Front/Rear Facia Trim (R)
- 4 - 3/4" x 3 1/2" x 72 1/4" - Side Facia
- 4 - Facia Detail Plates -Sides - (2@3 1/2 & 2@4 1/2" High)
- 2 - Pentagon Detail Plates (front and back)
- 4 - Triangular Corner Gable Trim Pieces (2 L / 2R)

**Filler Shingles (5 1/2" wide)**

- 14 - Long Shingles
- 4 - Short Shingles

**Ridge Caps**

- 22 - Cedar Shingle Roof Ridge Caps

**Flower Boxes & Window Trim**

- 7 - Flower Box Kits

- 4 Reg Window Trim Pkgs: 1 x 24 1/16" Top, 3 x 23" Bottom & Sides
- 6 Sm. Window Trim Pkgs: 1 x 20 1/4" Top, 2 x 21 7/16" Sides,  
1 x 19 1/4" Bottom

**Potting Shelves**

- 3 - 16" x 45" - Long Potting Shelves
- 1 - 16" x 41" - Short Potting Shelf
- 8 - 1 1/2" x 2 1/2" x 35" - Potting Shelf Legs

**\*\*Miscellaneous Pieces**

- 1 pc - Spare Wall Siding
- 2 pcs - Spare Shingles- use to shim door, etc

# 12x12 SUNSHED HARDWARE SHEET

## Hardware Kit (Provided)

Note: screws and nails shown actual size.

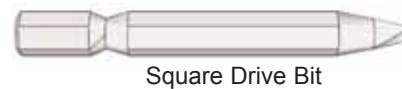
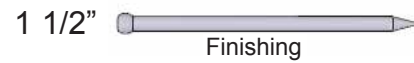

Tee Hinge x4



Pull Handle



Black Barrel Bolt



Simpson Strong Tie (Roof) x 8



Ridge Board Connector x 2



Silver Barrel Bolt



Silicon Caulking

## Tools Required (Not Provided)



Hammer



Screw Gun/Drill



Tape Measure



Wood Clamp



Caulking Gun



Level



Pliers



Ladder



1/8" Drill Bits

## Safety Equipment Required (Not Provided)



Safety Glasses



Work Gloves

# A. Floor Section

Exploded view of all parts necessary to complete Floor Section. Identify all parts prior to starting. Note, Floor Footprint is 136 1/2" deep x 141 1/2" wide.

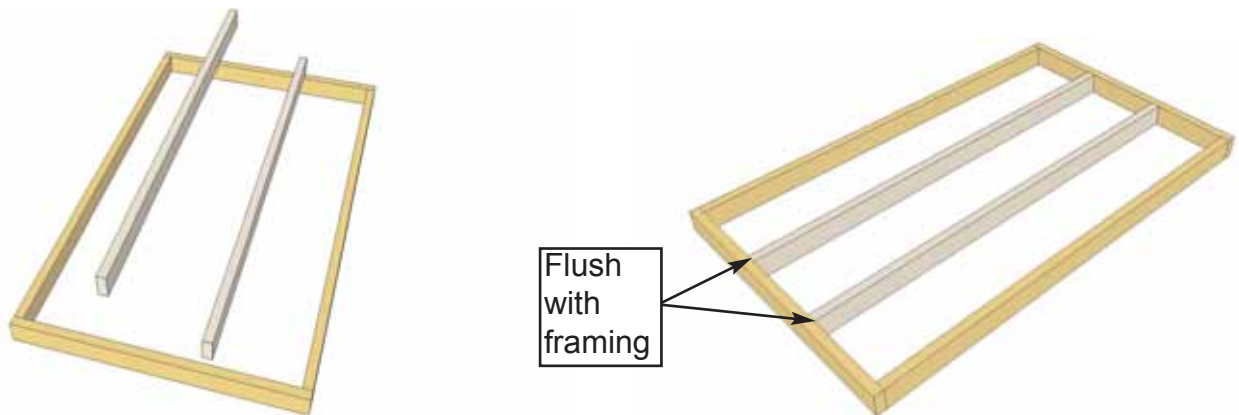
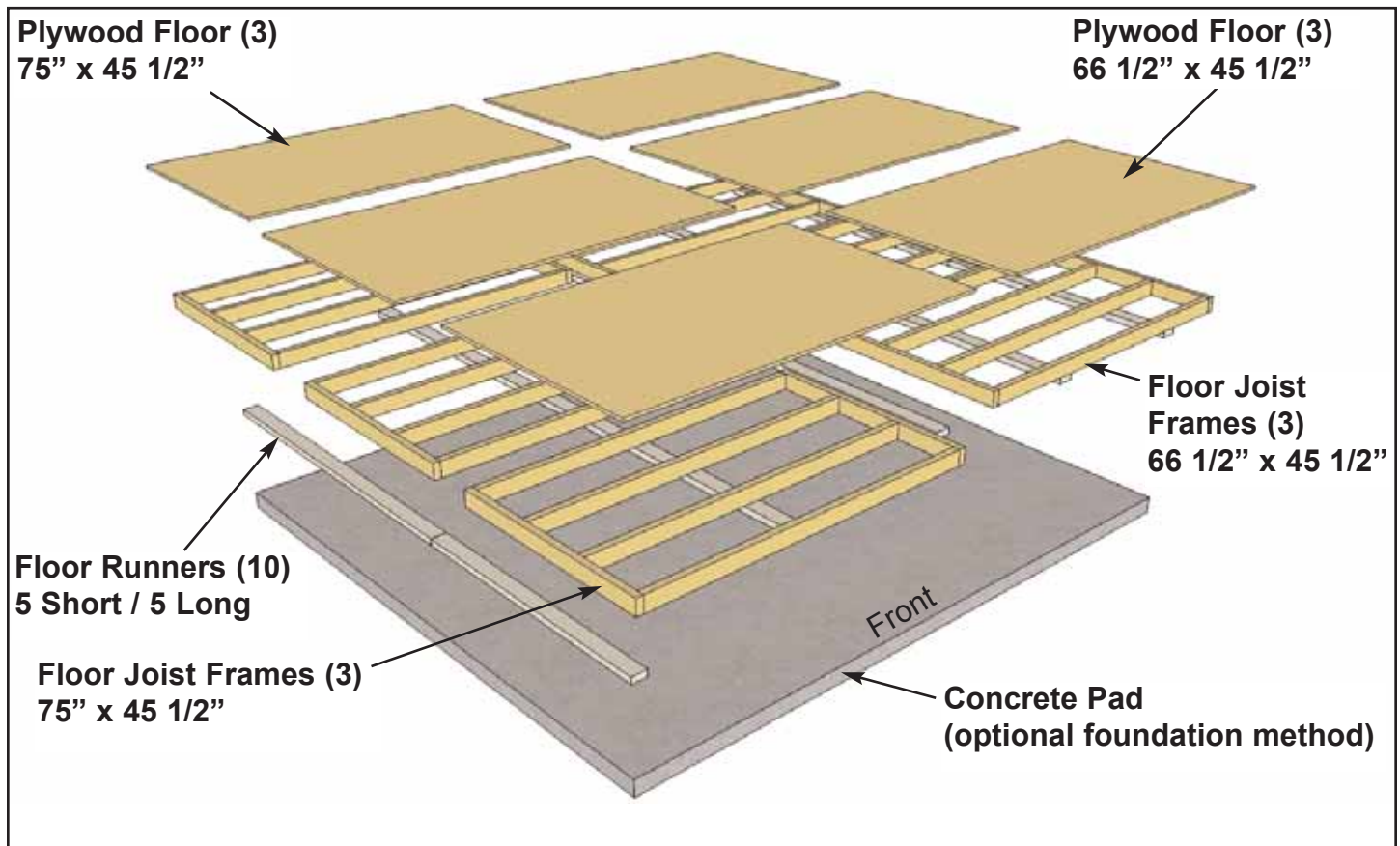

- 1.** Lay out all **Floor Joist Frames and Floor Joists** on ground as illustrated above. Position 72" Floor Joists in 75" frames and 63 1/2" Floor Joists in 66 1/2" frames. Position Joists equally in Floor Joist Frame. Position Joist so flush with framing.

**You can find the Square Drive Bit for the screws in with the Hardware Kit Bag.**

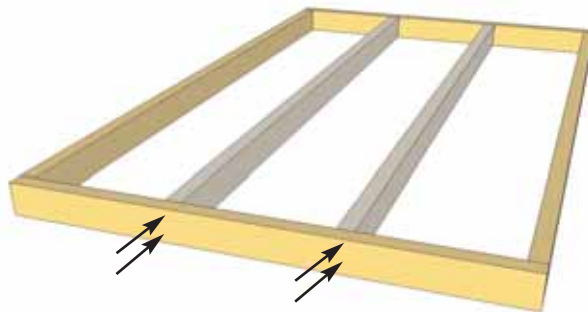

**2.** When correctly positioned, attach each Joist with 4 - 2 1/2" screws (2 per end). Complete all Floor Frame and Joist connections. **You can find the Square Drive Bit for the screws in with the Hardware Kit Bag.**

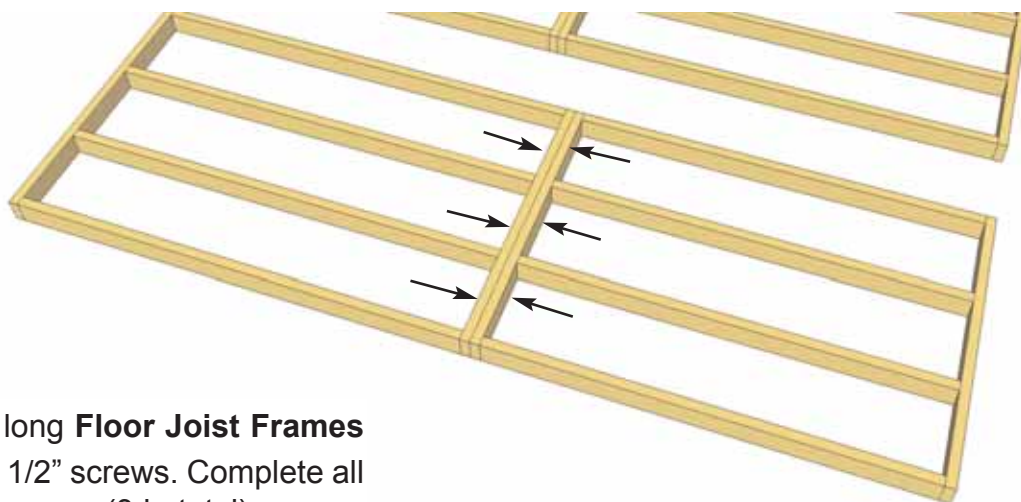

**3.** Lay out 66 1/2" and 75" long **Floor Joist Frames** and attach together with 6 - 2 1/2" screws. Complete all Long and Short Floor Frames now. (3 in total).

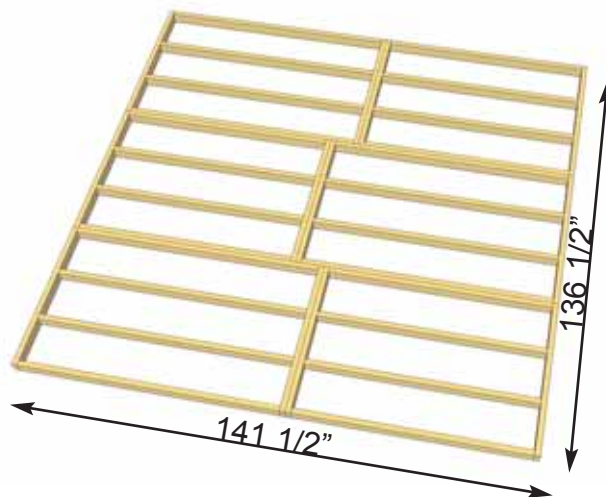
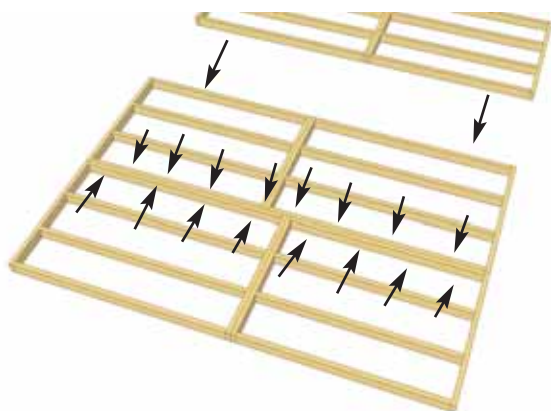

**4.** Now attach each completed section together with 16 - 2 1/2" screws as illustrated above.

**5.** When completed, your floor footprint should be 136 1/2" deep x 141 1/2" wide.



**6.** Attach **Floor Runners** to completed floor frame. There are 2 floor runners per 136 1/2" side and 5 completed runners in total. Use 6 - 2 1/2" screws per Runner.

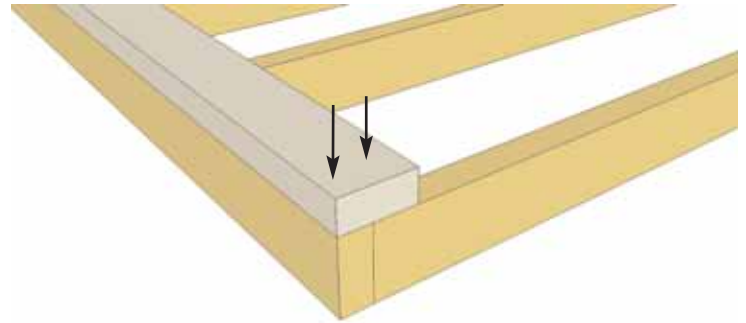

**7.** Make sure Runners are flush with outside and front and rear floor framing, not overhanging.



#### Foundations

**Note:** The floor will be flipped over and floor runners will sit on your foundation. It is important to note that having a level foundation is critical. Choosing a foundation will vary between regions. Typical foundations can be concrete pads or patio stones positioned underneath the floor runners.

**8.** Complete all Floor Runners.

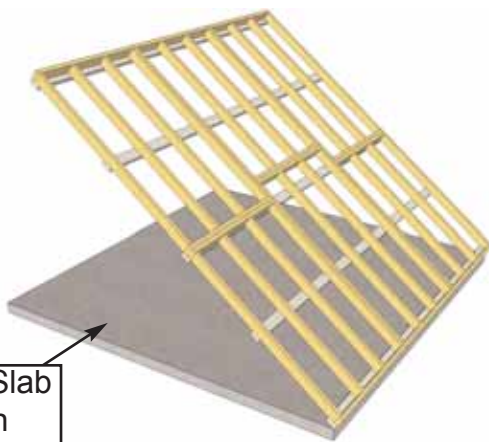

**9.** With Floor Runners attached, carefully flip the floor over and place on your foundation. **Caution:** you will need 2 people to assist you. Be careful when laying floor down not to bend or twist floor. When in place, level floor completely.

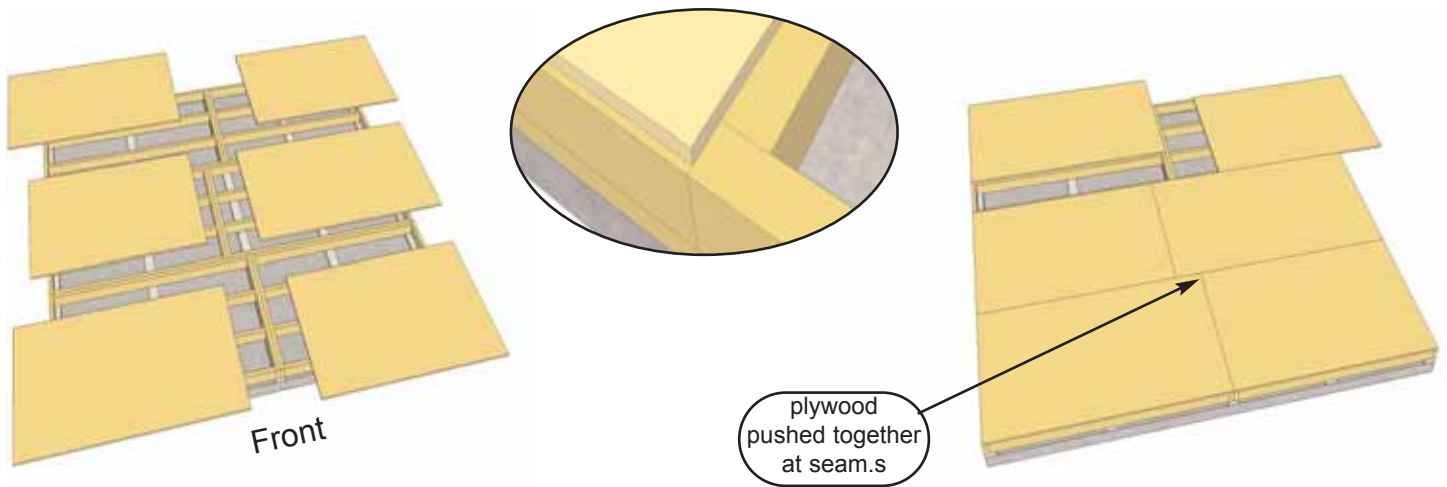

**10.** Position **Plywood Floor** pieces (6) on top of completed Floor Joists. Plywood will sit slightly back from outside edge of Floor Joist Framing.

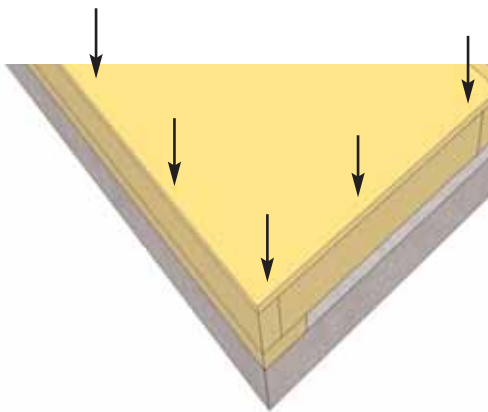

**Hint:** Use a chalk line to mark location of floor joists to determine screw placement.

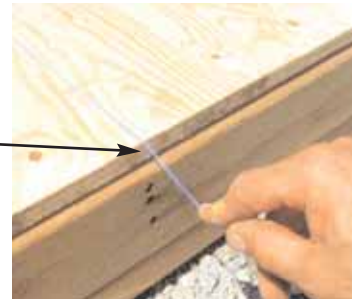

**11.** With Plywood positioned correctly on floor framing, attach with 1 1/4" screws. Use screws every 16". The Plywood is cut slightly smaller than floor framing. Keep plywood seams tight.

**Important:** Check to confirm that your floor is level prior to proceeding to the next step of wall assembly.

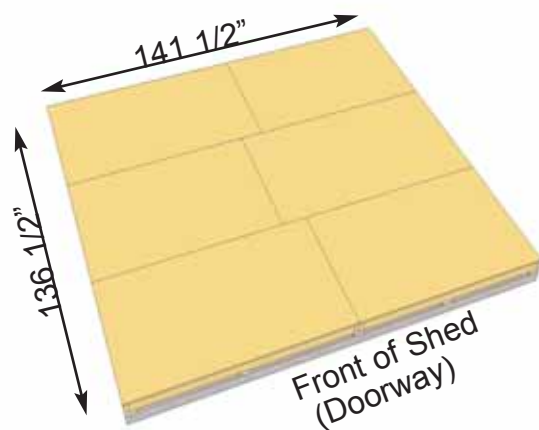

# B. Wall Section

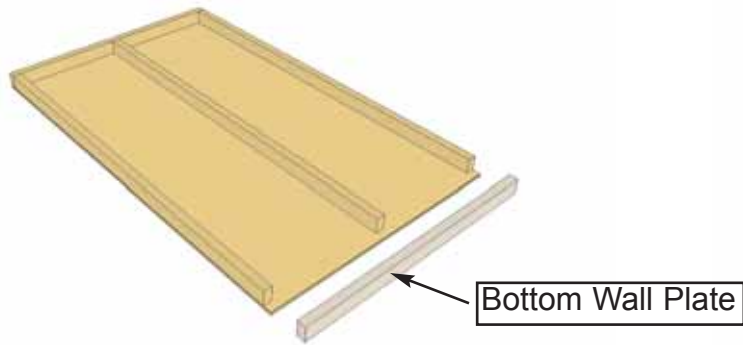

**Important:**  
Pilot hole **ALL** 2x3 Wall Studs with 1/8" drill bit prior to screwing. This will make it much easier to attached together.

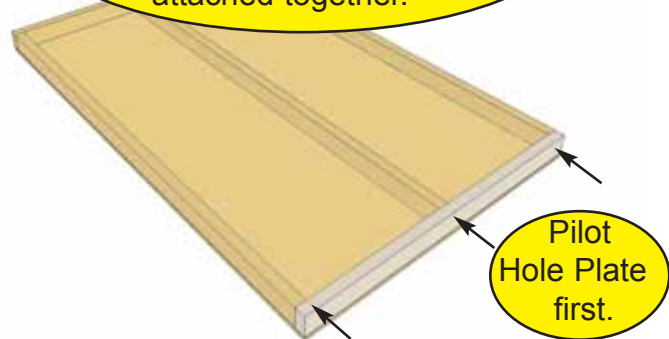

**12.** Starting with **Solid Wall Panels**, carefully lay panel face down. Position and attach **Wall Plate** to bottom of wall studs of each wall panel with 3 - 2 1/2" screws. Position so plates are flush with framing. **Note:** bottom Wall Plates may already be attached to some Solid Walls.

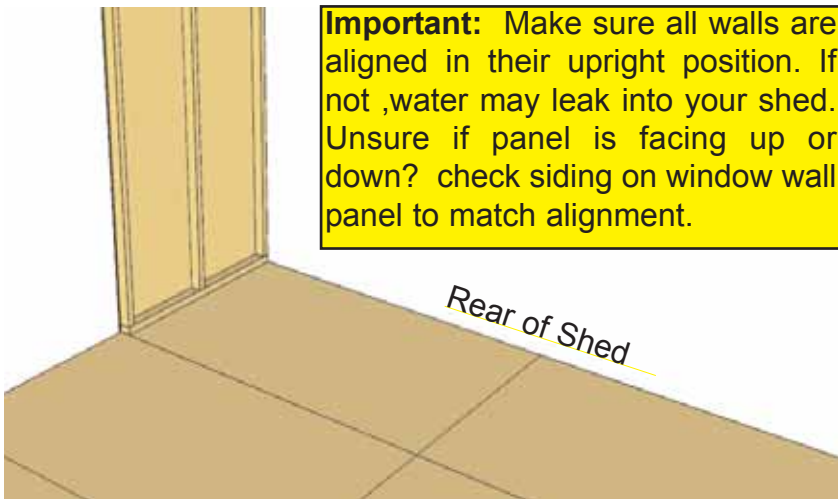

**Important:** Make sure all walls are aligned in their upright position. If not, water may leak into your shed. Unsure if panel is facing up or down? check siding on window wall panel to match alignment.

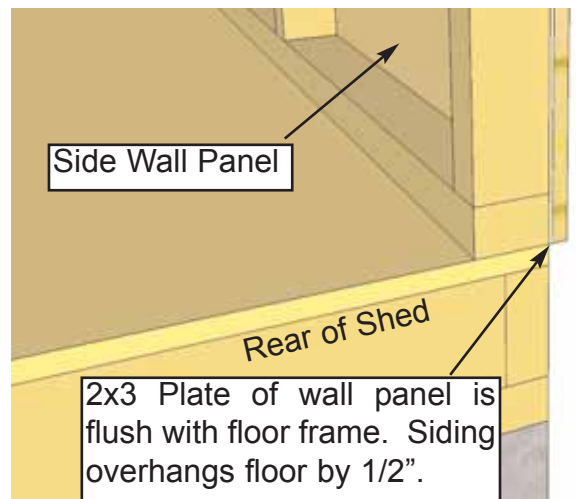

2x3 Plate of wall panel is flush with floor frame. Siding overhangs floor by 1/2".

**13.** Starting at Rear Corner, position a Solid Wall Panel on top of plywood floor. Make sure panel is facing up. The side wall panels will sit flush with floor frame with the front and rear panels sandwiched between them. **Note:** siding will overhang the floor by approx. 1/2".

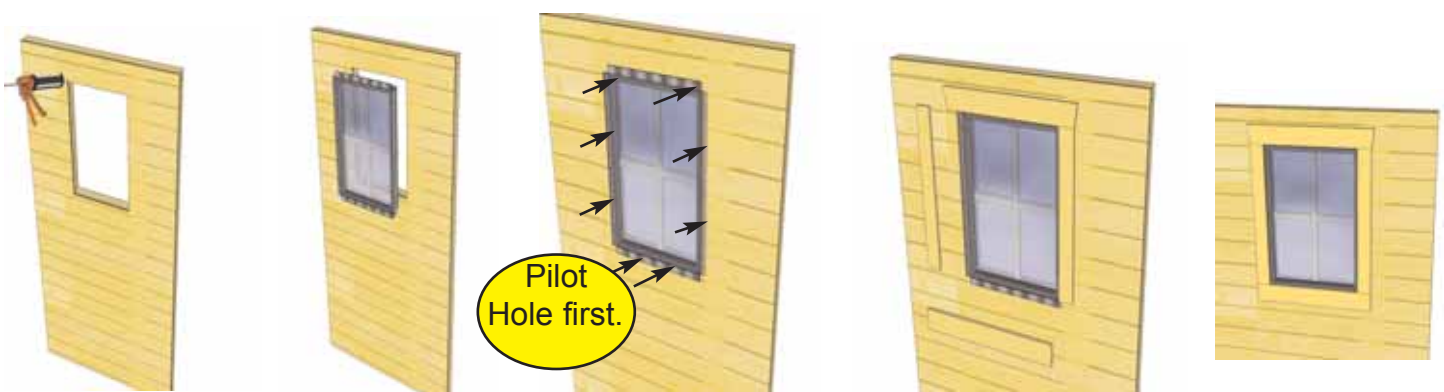

**Pilot Hole first.**

**14.** Locate **Window Inserts for both Regular and Narrow Double Walls**. Before installing, run a bead of caulking around window opening perimeter. Position window in cavity and secure with 8 - 1 1/4" screws. Position Window Trim around window doing a dry run first and attach with 4 - 1 1/2" finishing nails per piece. Trim Sizes = Reg. Window: 1 x 24 1/16" top, 3 x 23" sides & Bottom. Small Window: 1 x 20 1/4" top, 2 x 21 7/16" sides, 1 x 19 1/4" Bottom



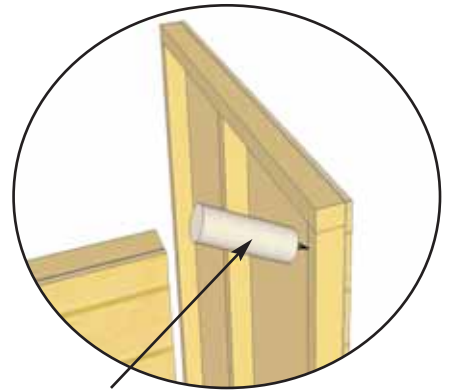
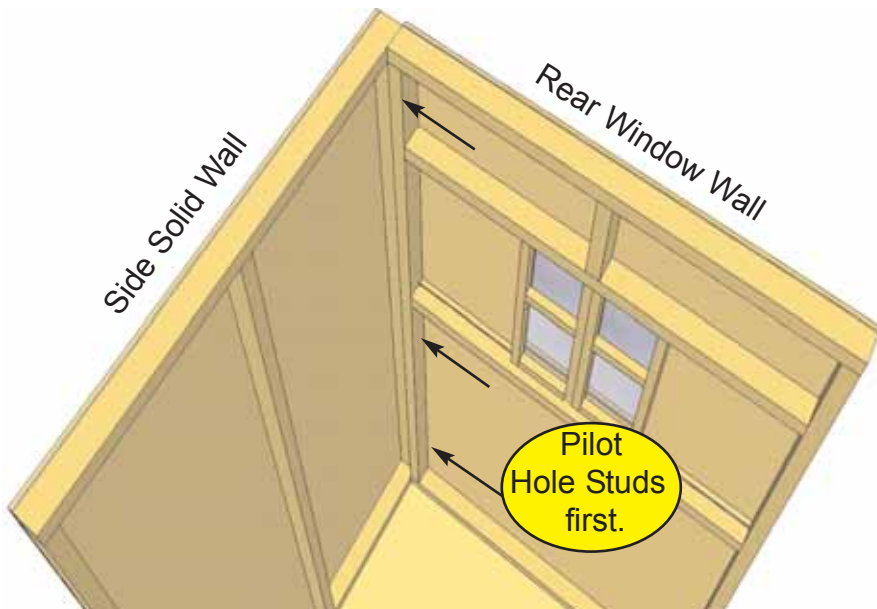

**Optional:** Caulking seams will help prevent moisture from entering your shed. Caulking is included to complete Lexan Windows only. Additional Caulking may be required.

**15.** Position rear Window Wall Panel into place on plywood floor. Butt both vertical wall studs of side and rear walls together and attach with 3 - 2 1/2" screws. Screw at the bottom, middle and top of stud to secure properly.

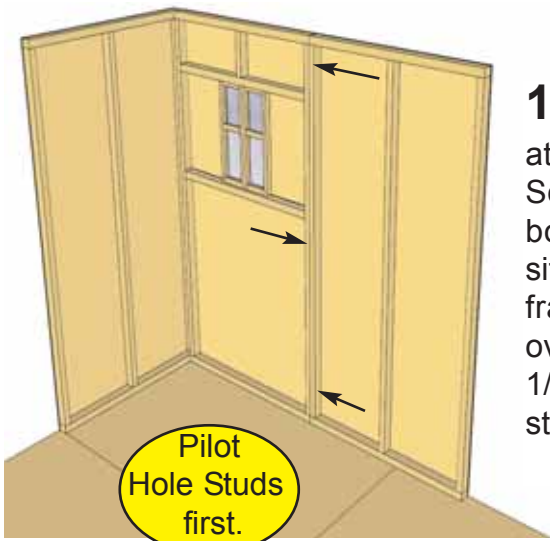

**16.** With the corner wall attachment complete, position a Solid Rear Wall Panel so bottom 2x3 wall framing is sitting flush with outside floor frame. Wall siding should overhang floor by approximately 1/2". Attach rear wall panel studs together as per **Step 15**.

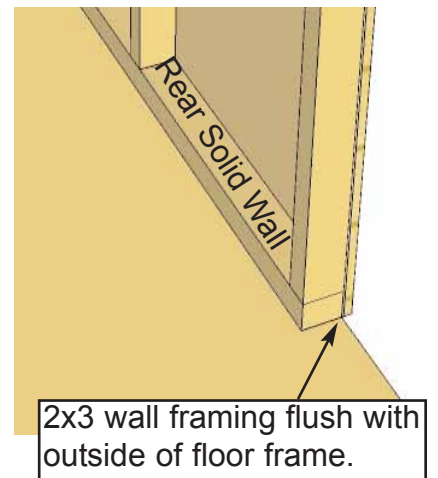

**17.** Position the final Rear Panel on the floor (Window Wall Panel). Position vertical wall studs together and attach as per **Step 15**.



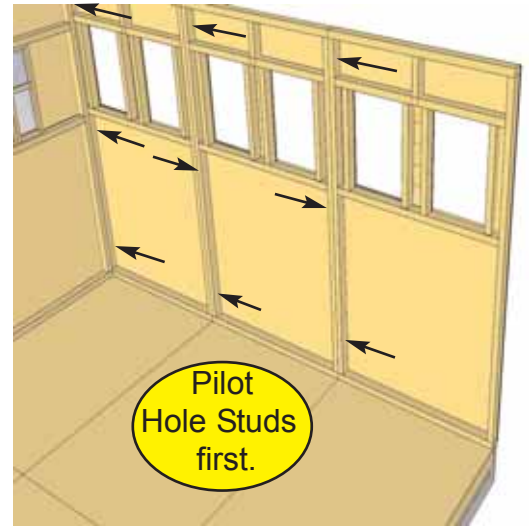
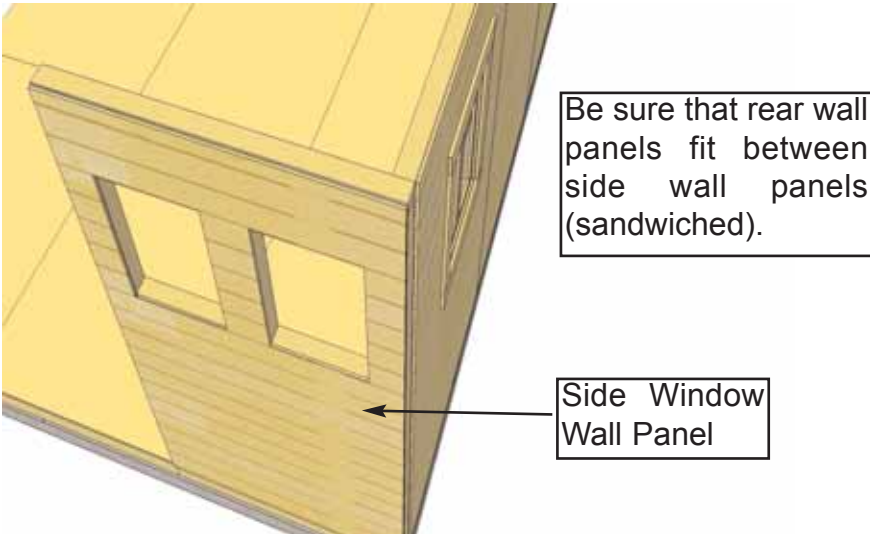

**18.** Attach a Side Window Wall Panel (2 windows in panel) in corner. Attach as per **Step 15**. Start positioning and securing remaining Side Window Wall Panels on your floor. Attach wall studs together as per **Step 15**.

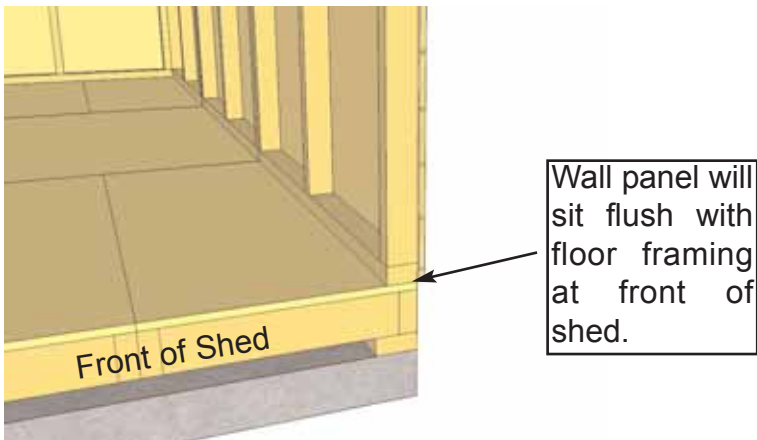

**19.** Complete attachment of left Side Wall Panels. At the front of the shed, side walls will sit flush with front of floor framing.

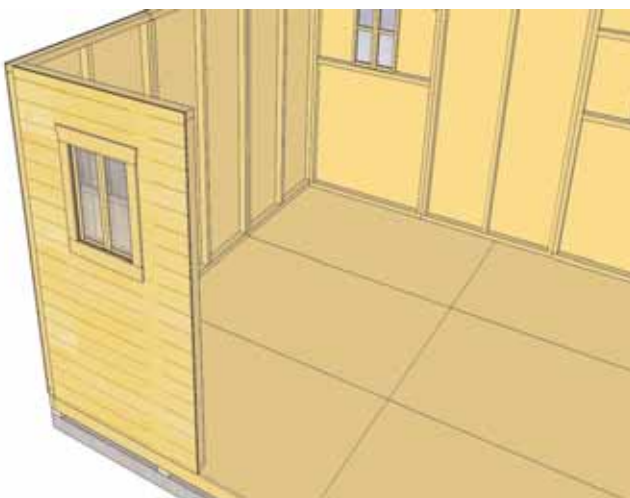

**20.** In the Front Corner, attach a Window Wall Panel. Line wall studs up as per **Step 15** and secure together.

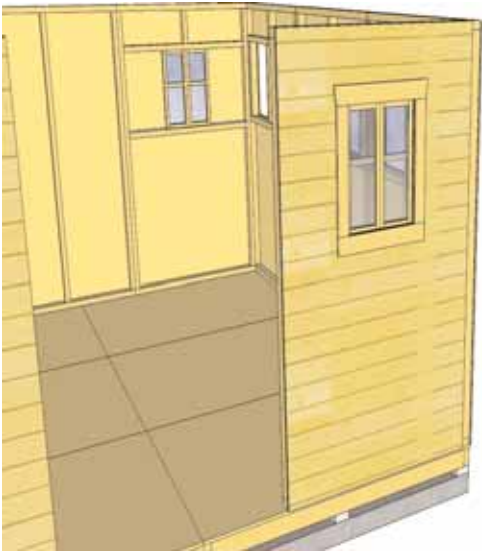

Narrow Wall Panel (can go on left or right side).

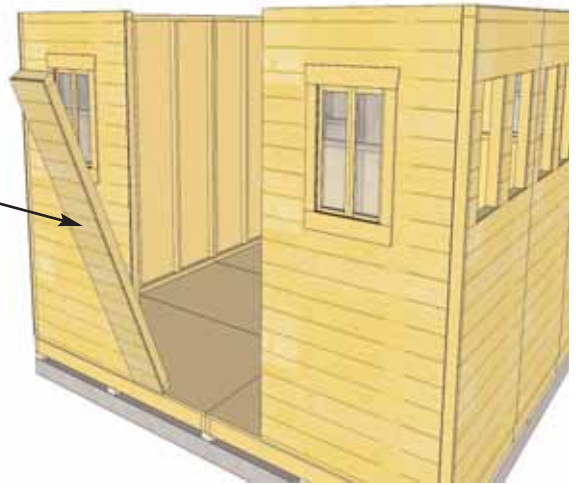

**21.** Secure 2nd Front Corner Window Wall Panel. Place Narrow Wall Panel adjacent to either left or right Window Wall - your choice.

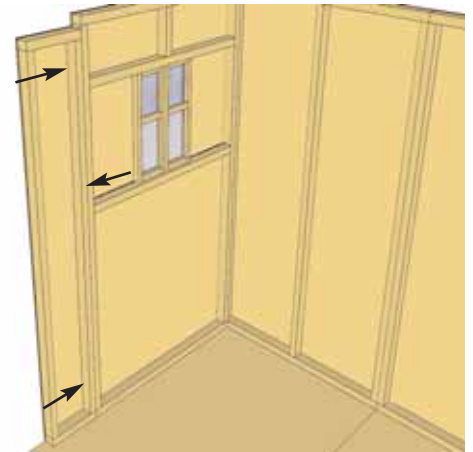

**22.** Line up Window Wall and Narrow Wall so flush with each other on the outside. Attach studs together with 3 - 2 1/2" screws as per **Step 15**. **Note:** Narrow Wall is 73" high (2" shorter than Window Wall).

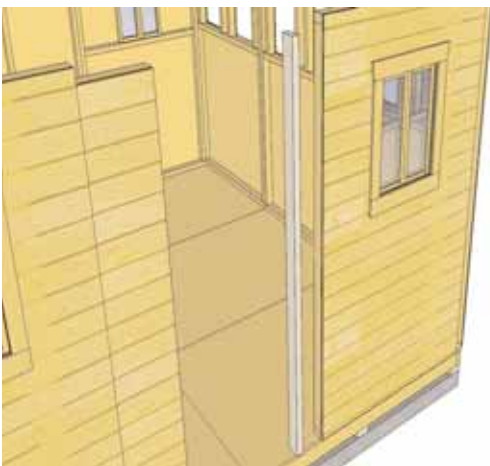

Jamb sits flush with Wall framing

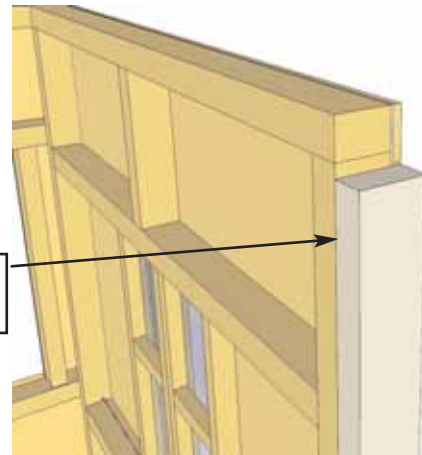

**23.** Locate Vertical Door Jamb and position flush against right wall panel stud. The Jamb is 3" wide and will sit flush to outside of wall siding. When positioned correctly, secure Jamb using 4 - 2 1/2" screws.

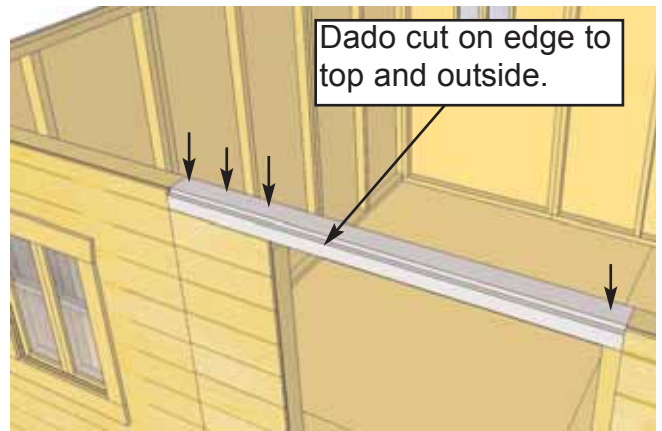
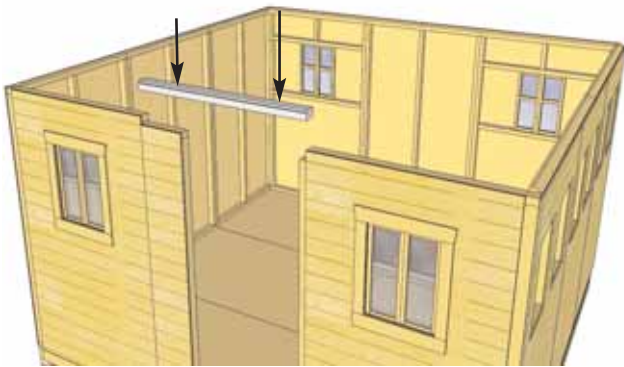

**24.** Position and attach the Door Header to Door Jamb and Narrow Wall Panel top framing. Header should sit flush with Door Jamb and Outside of Narrow Wall Siding. Attach with 4 - 2 1/2" screws.

**Important:** If walls are not lining up and appear higher or lower than each other, please check the level of your floor. You may need to make slight adjustments before proceeding.

**25.** When all walls are attached together, check alignment with the floor. Bottom wall framing should sit flush with outside of floor joists. When positioned correctly, fasten bottom wall plates to floor using 4 - 2 1/2" screws per wall panel. **Confirm 32" wide door opening at bottom.**

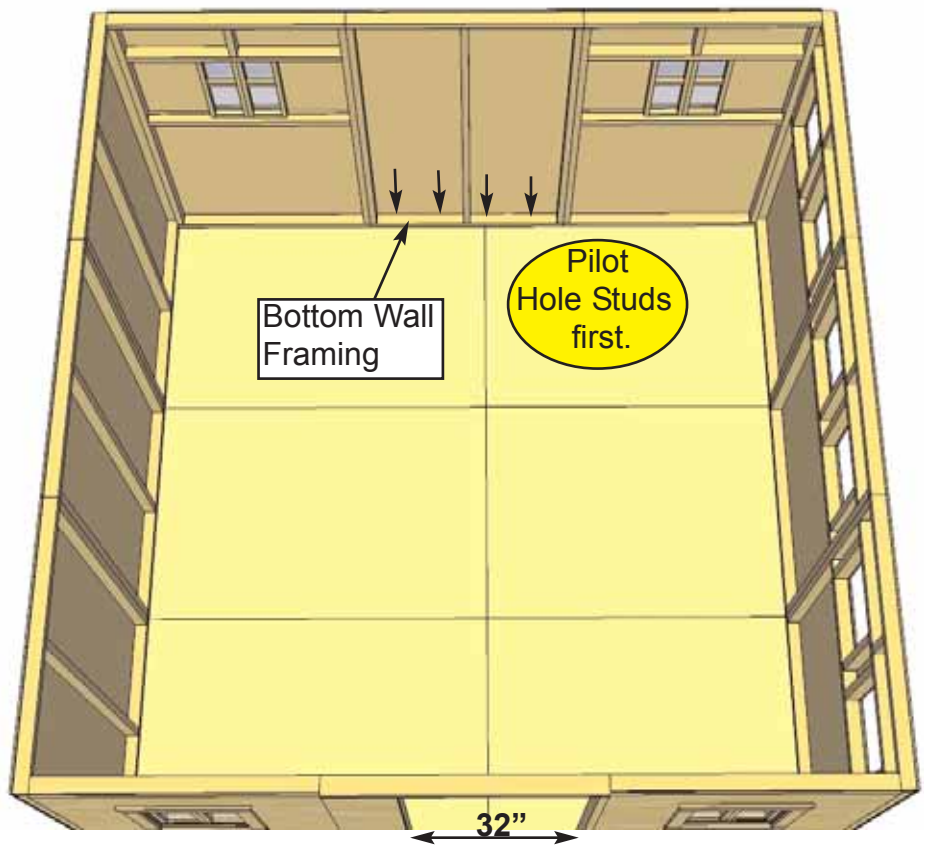

Angle screws into perimeter Floor Joists.

**Optional:** Caulking seams will help prevent moisture from entering your shed. Caulking is included to complete Lexan Windows only. Additional Caulking may be required.

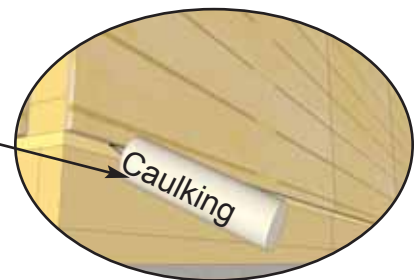

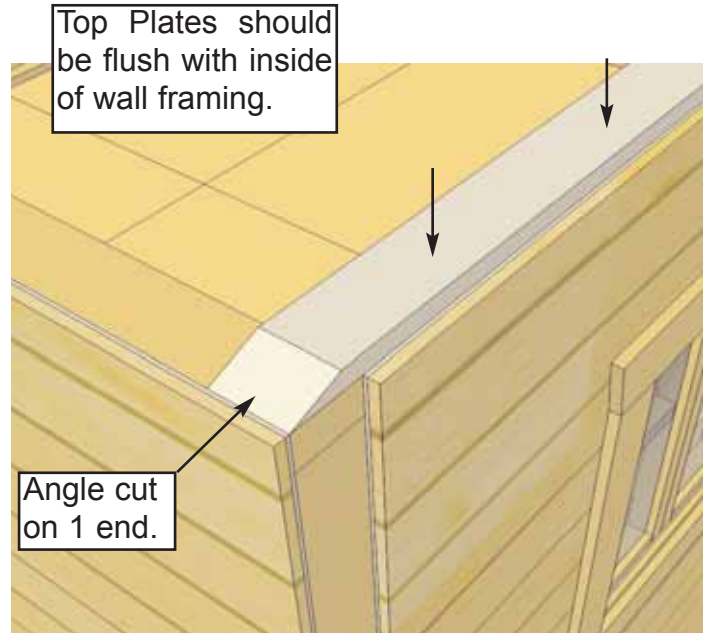
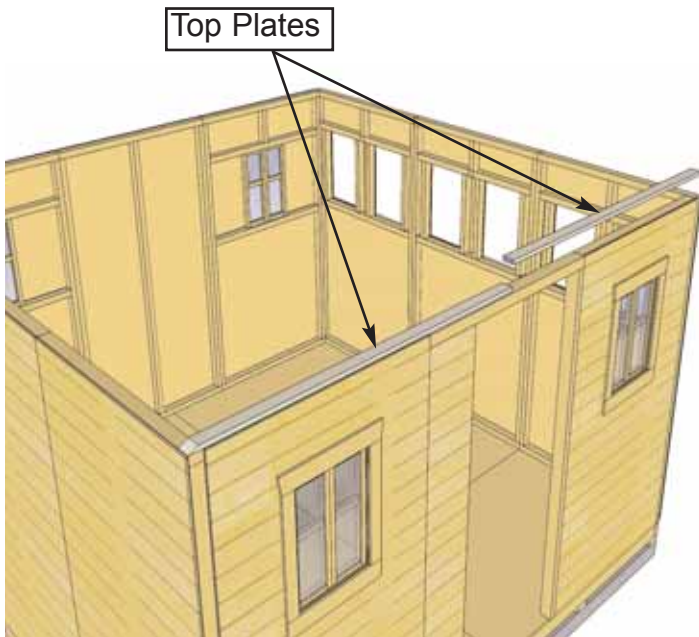

**26.** Position **Front Top Plates** on top of wall framing so they are flush on the inside with 2x3 wall frame. There are 2 Front Top Plates. Together, the plates should be centered evenly on the wall left to right. Attach by screwing down into top wall framing with 4 - 2" screws per Plate.

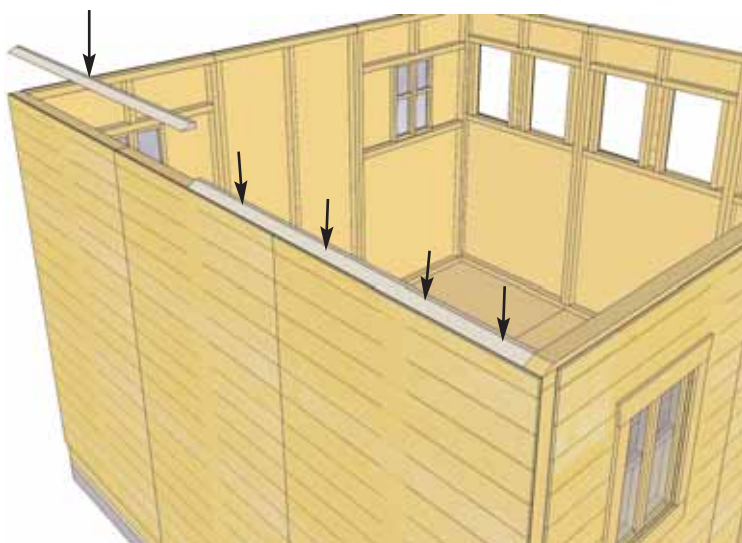

**27.** Next, attach the 2 **Side Top Plates**. The side top plates are angle cut down the length. Once again, position top plate on wall plate so it is flush with inside of wall plate. Side plate should also be flush with Front Top Plate. Secure with 4 - 2" screws per piece.

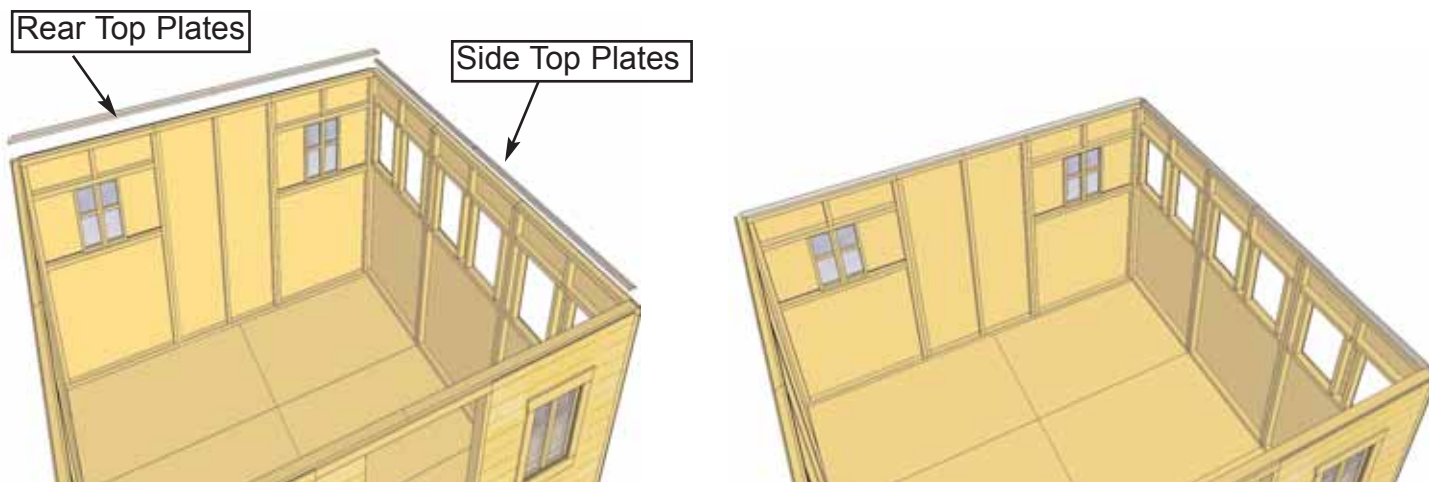

**28.** Position remaining Rear and Side Top Plates on wall top framing to complete. Use 4 - 2" screws per piece.

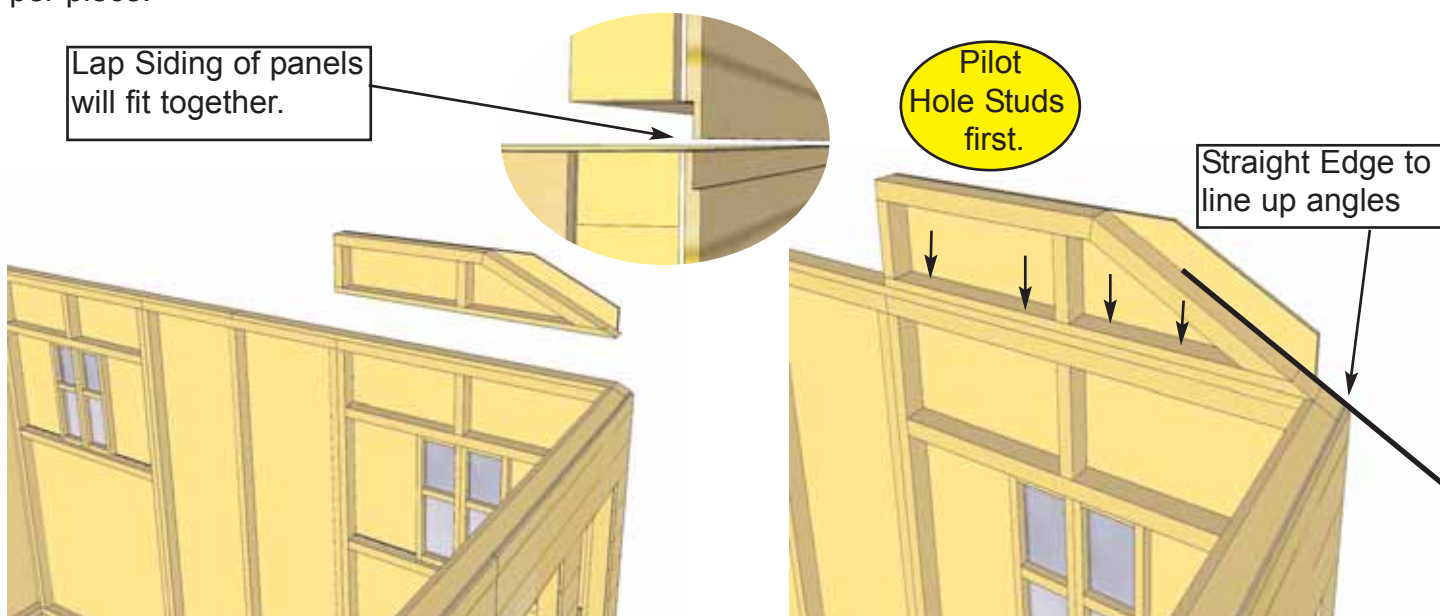

**29.** Locate and place an **Angled Wall Extendor** on Rear Wall Top Plate. Position so Top Plate and Extendor Wall angles line up and are flush with each other. When in place, secure with 4 - 2 1/2" screws per piece.

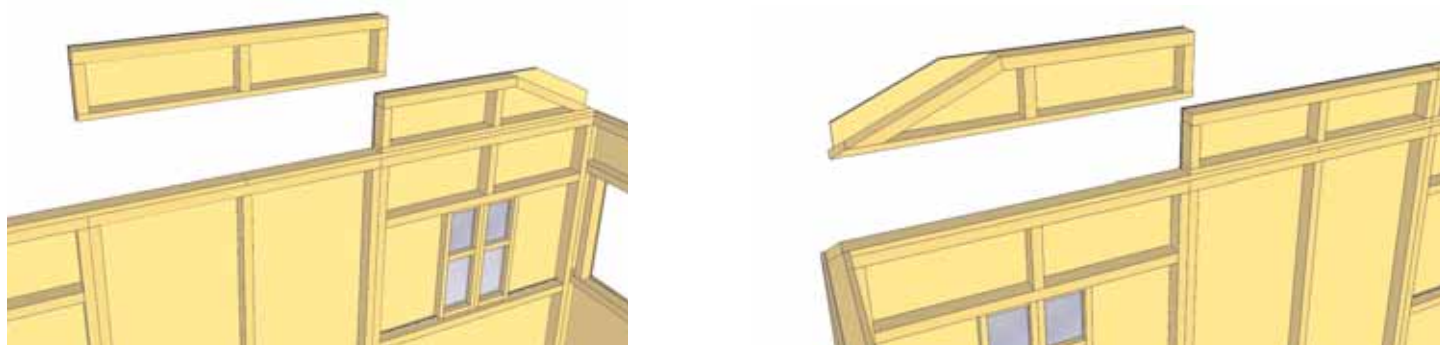

**30.** Locate and place the **Middle Wall Extendor** on Top Plate and flush with Angled Extendor Wall framing. When correctly in place, secure with 4 - 2 1/2" screws. Complete remaining Angled Wall Extendor attachment. Use 4 - 2 1/2" screws to connect Middle Wall to Angled Extendor Walls. See **Step 31.**

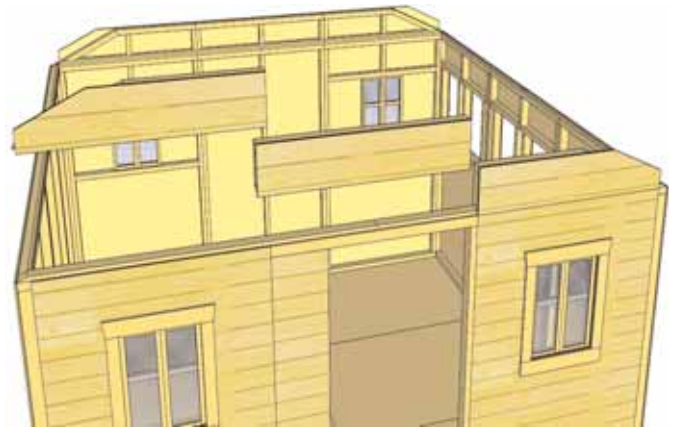
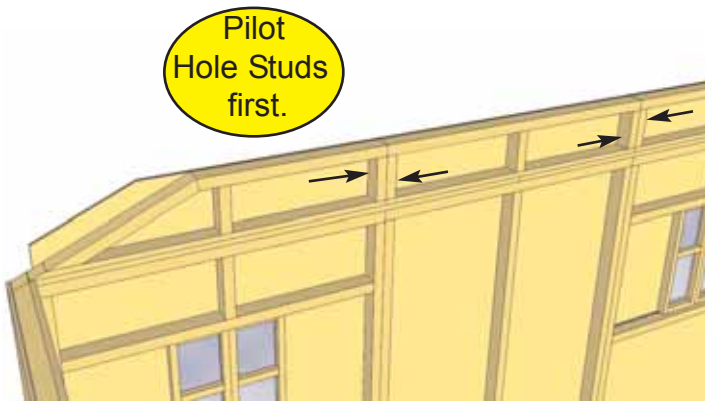

**31.** After completion of Rear Wall Extenders, complete the front wall Extenders following Steps 29-30.

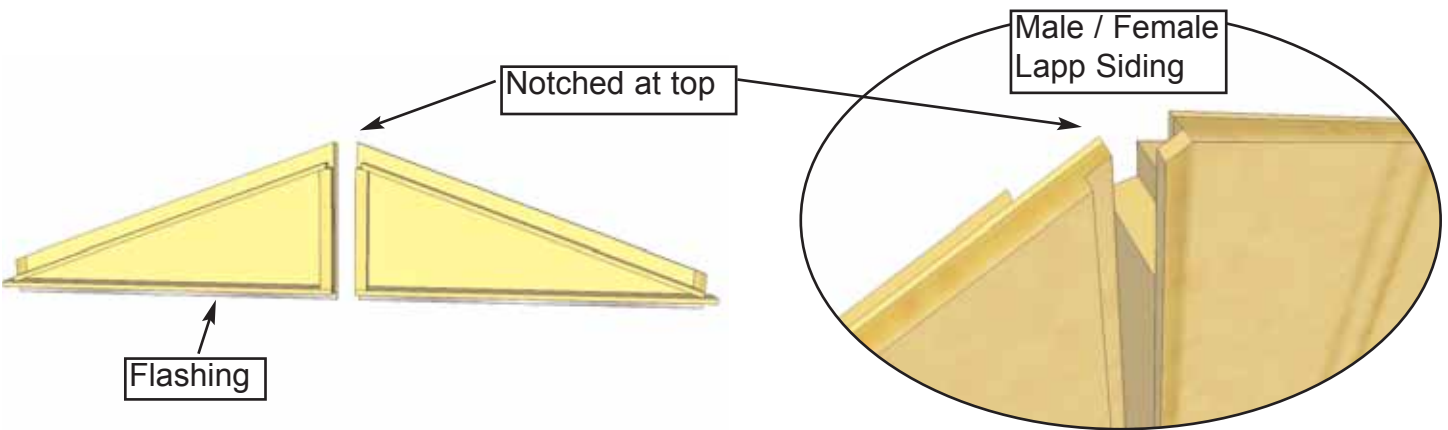

**32.** Locate Gable 1/2 Walls for both sides of the shed. Align framing and wall siding lapp together. Screw center wall framing of each piece together with 3 - 2 1/2" screws. **Note:** prior to attaching, try each combination of Gables for best fit.

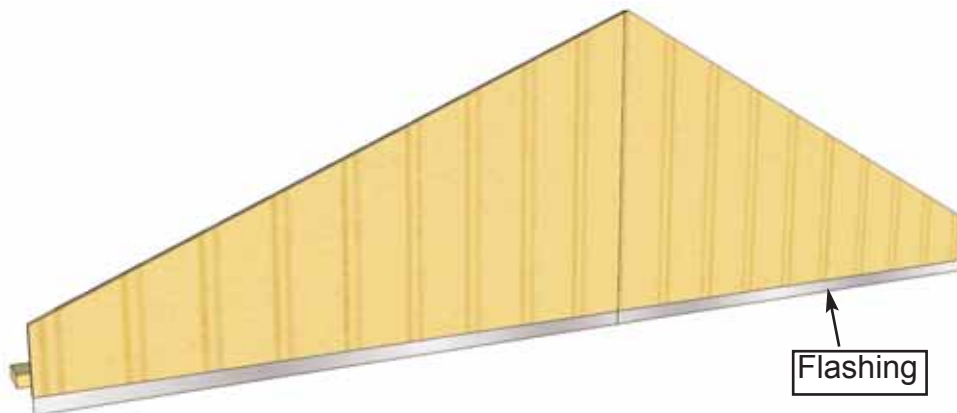
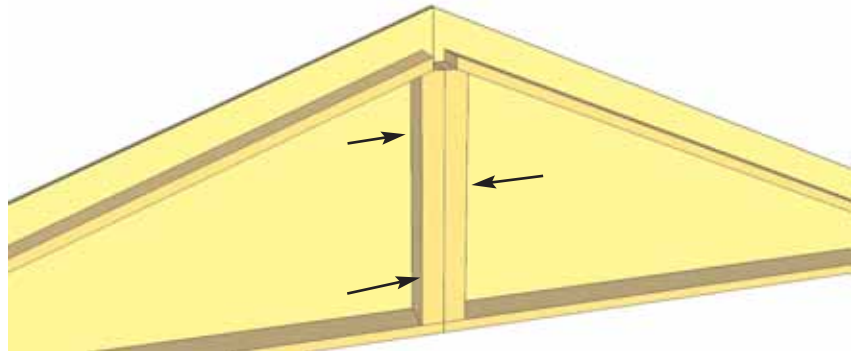

**33.** Lift completed Gable Section up and place on top of front Wall Extenders. Move Gable Section framing left to right to line up with Wall Extendor framing. Use a straight edge to check for correct alignment. When in place, tack down Gable framing for now with 4 - 2 1/2" screws. **Note:** Gable alignment may need to be adjusted after Rafters are installed.

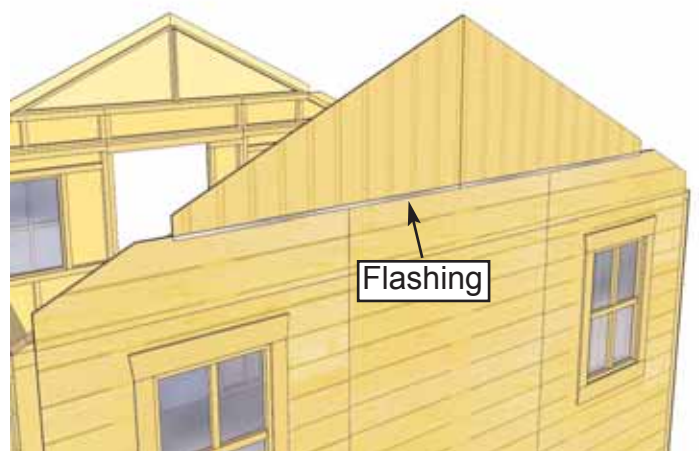
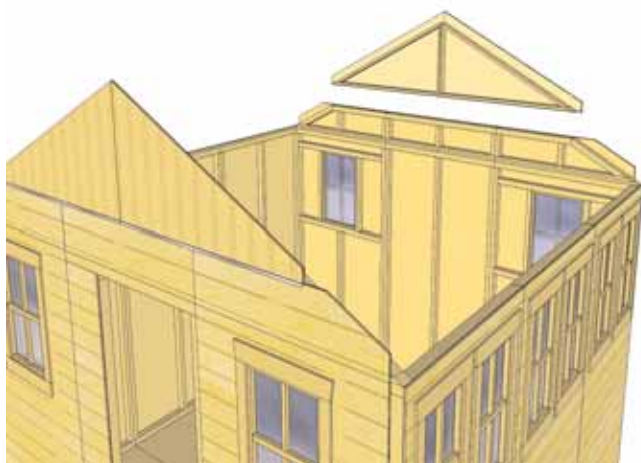
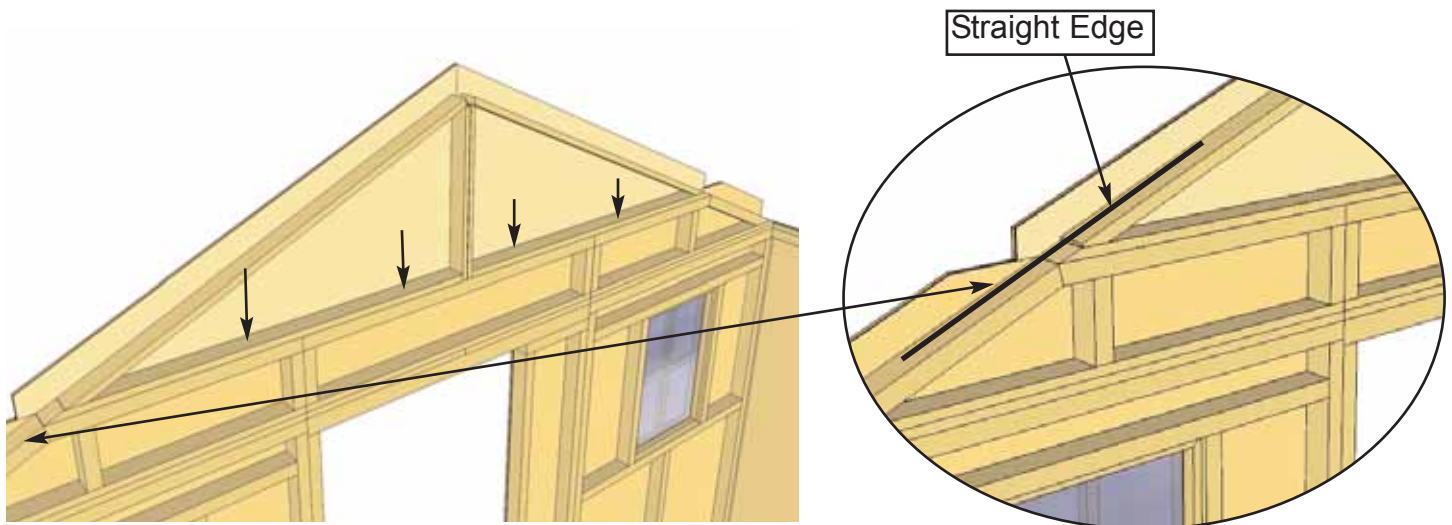

**34.** Lift, align and attach **Rear Gable Section** as per **Step 33**.



# C. Rafter & Roof Section

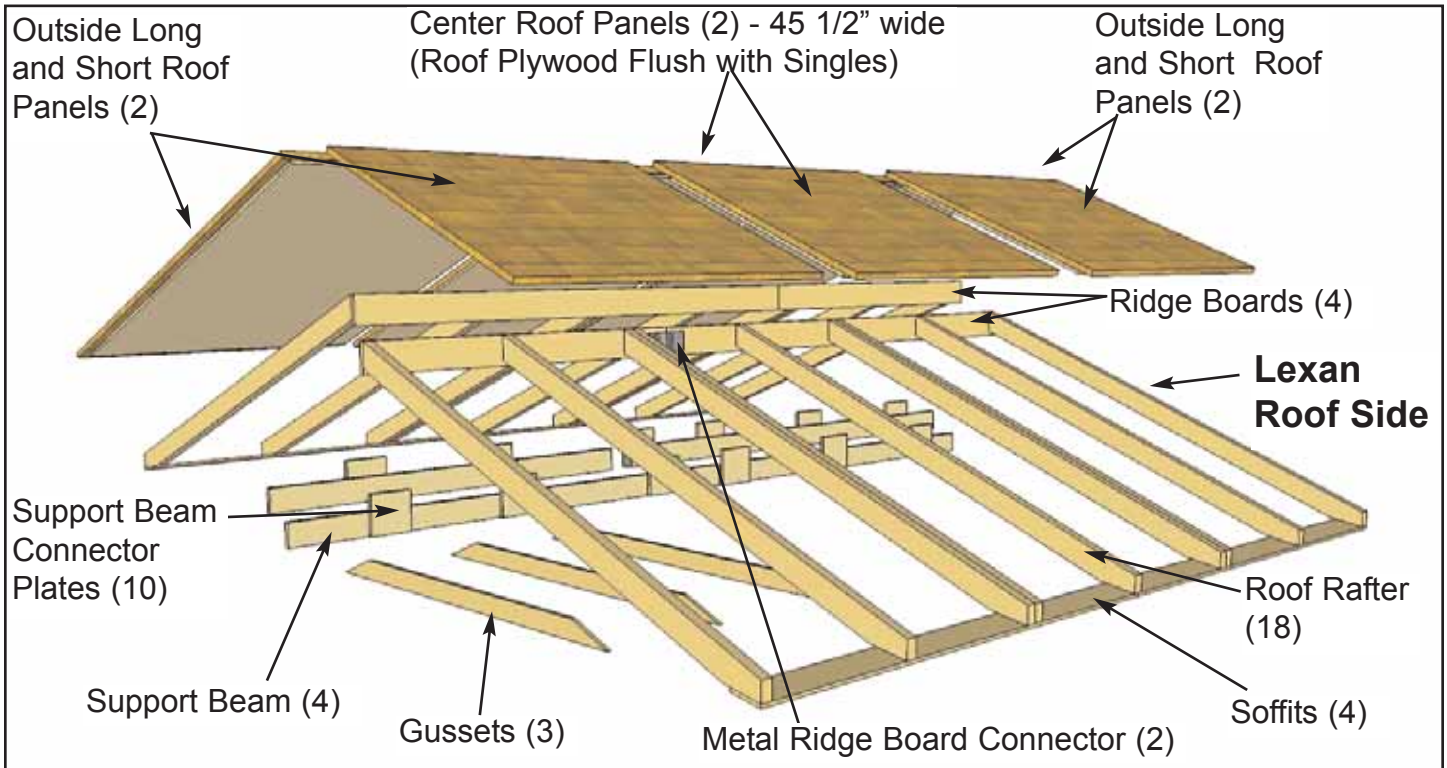

**Important:** Locate all parts necessary to assemble each Rafter Section prior to beginning.

**Parts for One Rafter Section**  
 9 - 81 1/8" long 1 1/2" x 3 1/2" Rafters  
 1 - 3/4" x 4 1/2" x 52 1/2" - Ridge Board  
 1 - 3/4" x 4 1/2" x 84" - Ridge Board  
 1 - 1/16" x 3" x 7" - Metal Ridge Board Con.  
 2 - 1/2" x 4 1/2" x 68 1/4" - Soffits  
 \* Must complete 2 Rafter Sections

**Remaining Rafter Pieces:**  
 2 - 3/4" x 3 1/2" x 56 1/2" - Support Beam Pieces  
 2 - 3/4" x 3 1/2" x 75" - Support Beam Pieces  
 10 - 5/8" x 6" x 6" - Support Beam Conn. Plates  
 3 - 3/4" x 3 1/2" x 72" - Gussets

Follow **Steps 35-38** to Assemble Rafter Sections. Make sure to complete on a flat, level surface.

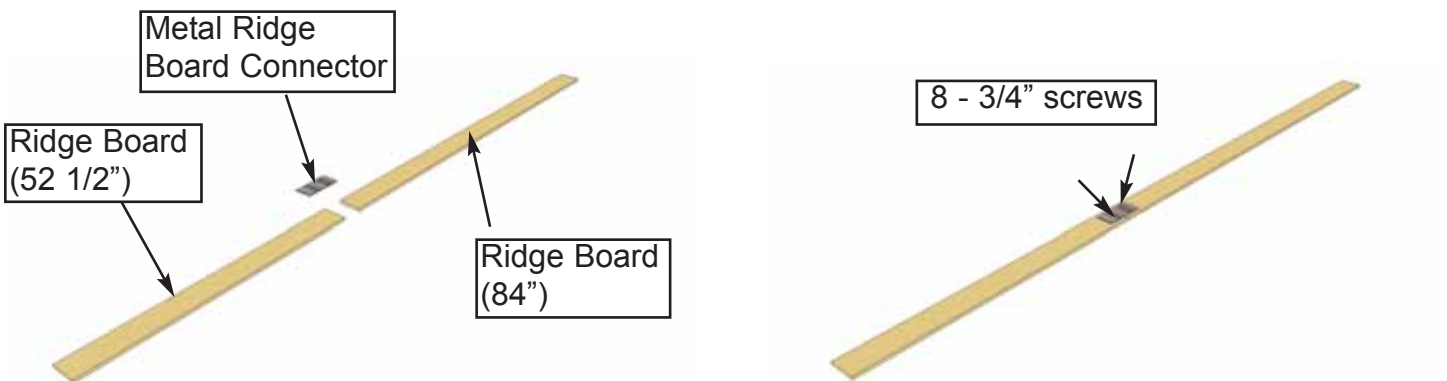

**35.** Locate 3/4" x 4 5/8" x 84" & 52 1/2" **Ridge Boards** and attach together with **Metal Ridge Board Connector** using 8 - 3/4" screws evenly on boards. Total Length when connected is 136 1/2". Complete two Ridge Boards.

**36.** Lay out 9 **Rafters**, 2 **Soffits** and completed Ridge Board on level ground as shown. Double up Rafters as illustrated. Screw doubled up Rafters together with 3 - 2 1/2" screws **Note:** completed rafter section will be flipped over in **Step 39**.

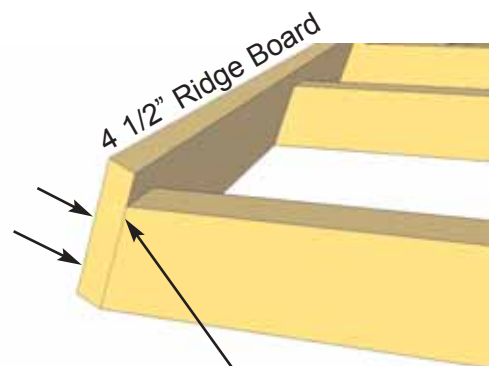
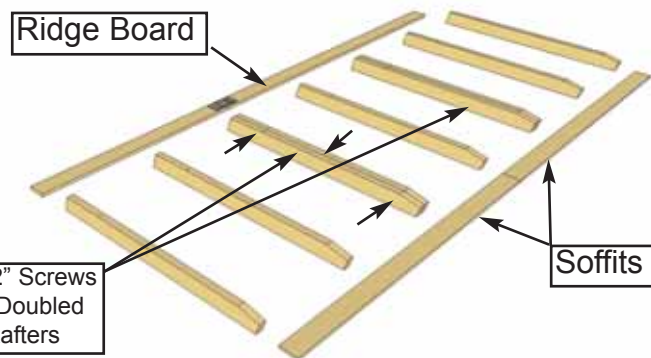

**37.** Attach completed Ridge Board to ends of both outside rafters with 2 - 2" screws per end. Measure and position interior Rafters as illustrated below. When positioned correctly, attach Ridge Board to remaining rafters with 2 - 2" screws /rafter end.

**Important:** Pilot Hole Ridge Board and Soffit to prevent splitting!

**Important:** Measure 20 1/2" spacing accurately to accommodate Lexan Panels. See Step 66.

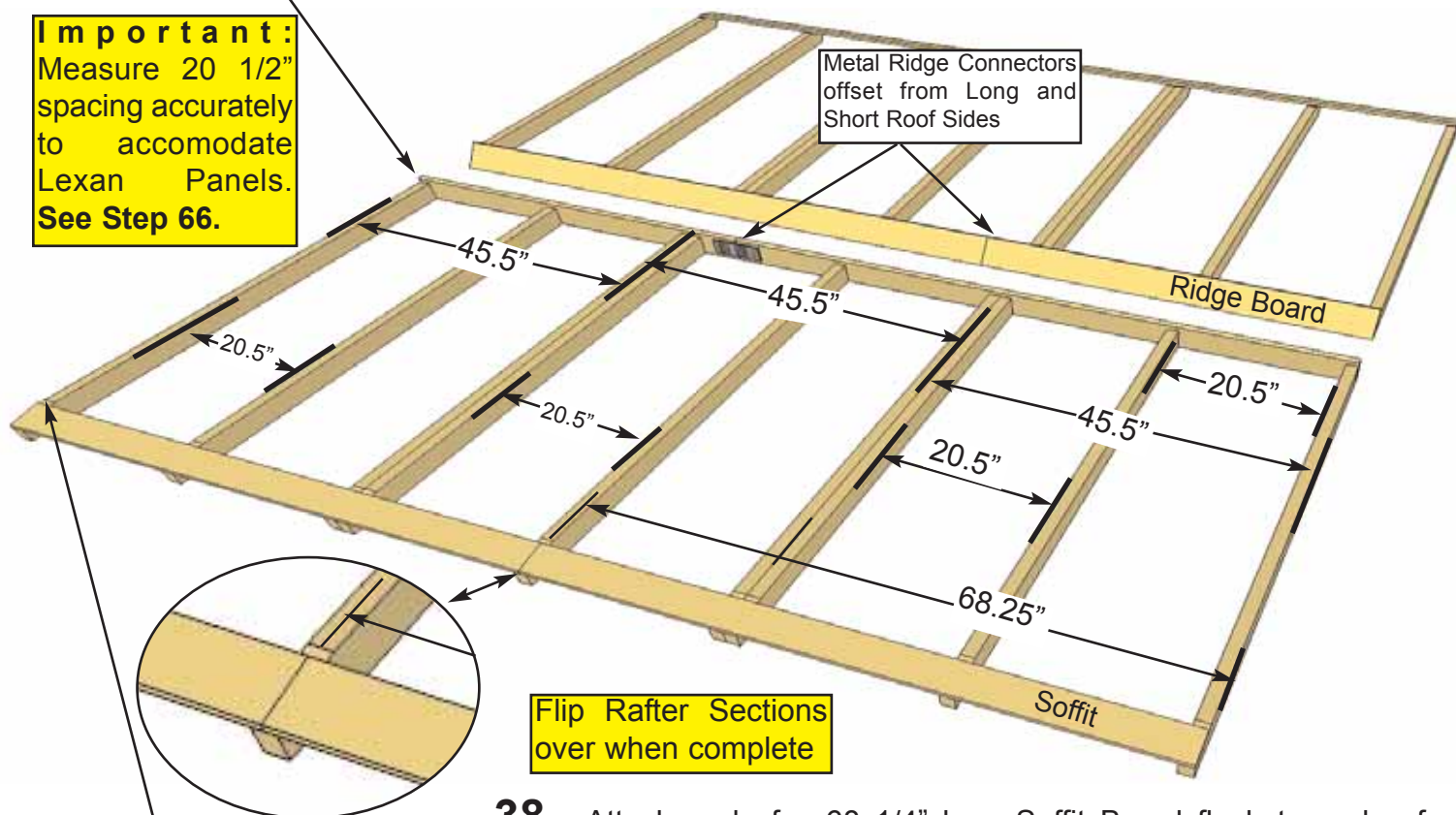

**Flip Rafter Sections over when complete**

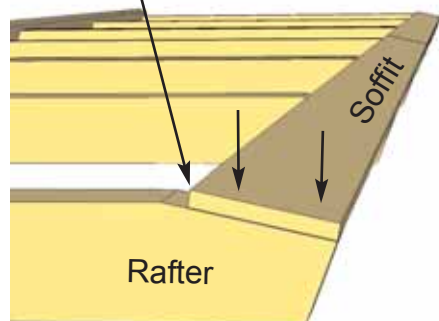

**38.** Attach end of a 68 1/4" long Soffit Board flush to ends of outside rafters with 2 - 1 1/4" screws per rafter end. Drill pilot holes in Soffit ends to prevent splitting. Complete both outside Rafter / Soffit connections first. Measure and position interior Rafters as illustrated above. When positioned correctly, attach Soffits to remaining rafters with 2 - 1 1/4" screws /rafter. **Important: Pilot Hole Soffits to prevent splitting.** Flip completed rafter section over. Complete remaining Rafter Section as per **Steps 36 - 38** with the following exception: **When attaching Ridge Board to Rafter ends, make sure Metal Ridge Board Connector is positioned so offset to first Rafter Section. See Step 43 for illustration.**

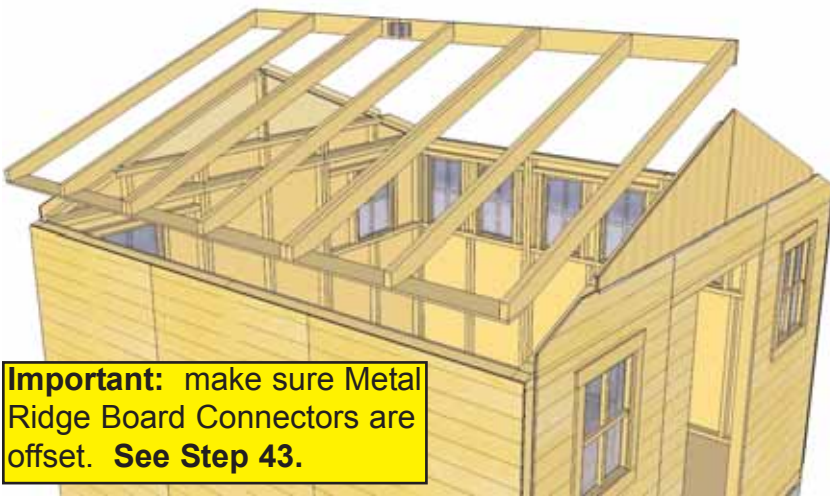

**Important:** make sure Metal Ridge Board Connectors are offset. **See Step 43.**

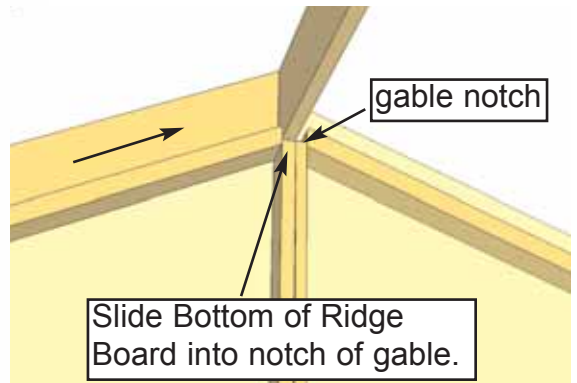

**39.** Starting with Long Shingle Roof Side, slide rafter up on gable framing until bottom of Ridge Board slips into gable notch. Position rafters so they sit evenly on Gable framing from side to side.



**40.** Where Wall and Soffit meet, a small gap may appear. Confirm all Rafters are resting on Top Plate.



**41.** Lift and flip 2nd Rafter Section up and place on Gable framing. **Make sure Metal Ridge Board Connectors of both Roof Sections are offset. See Step 43.**

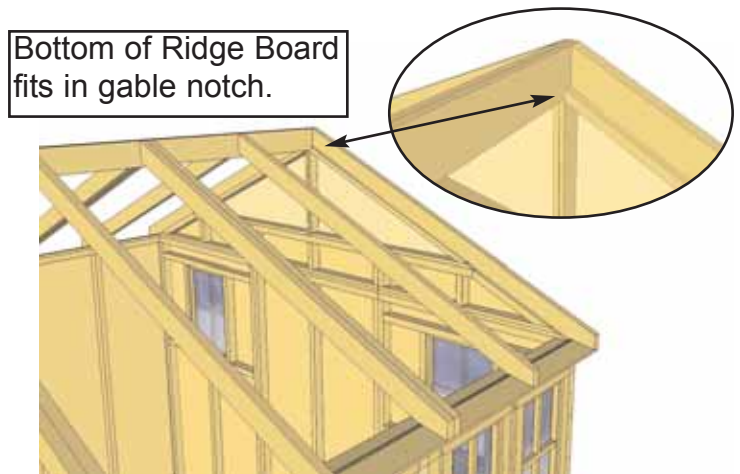
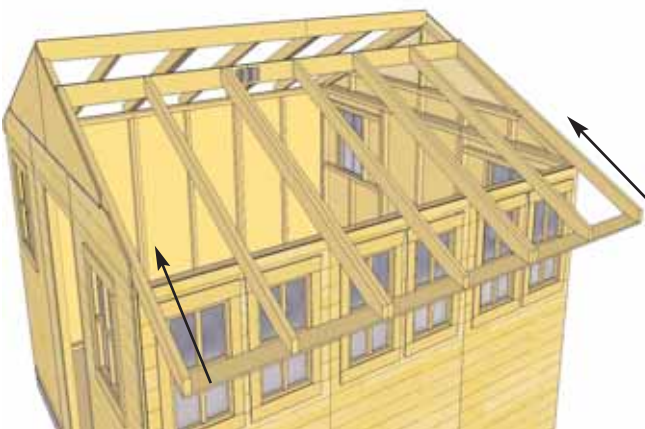

**42.** Slide Rafter Section up on Gable framing so bottom of ridge board slips into Gable notch. Soffit will sit approximately 1/8" away from wall as per **Step 40.**

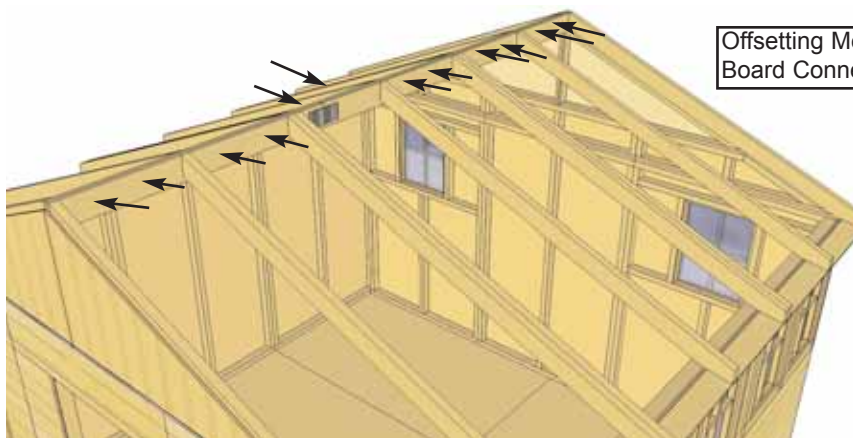

Offsetting Metal Ridge Board Connectors

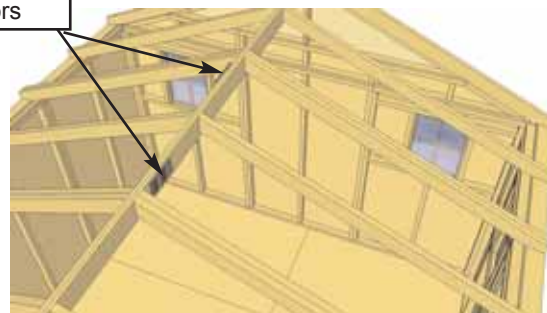

**43.** Where Ridge Boards meet, press together and secure with 12 - 1 1/4" screws. To completely secure Ridge Boards, place 4 - 1 1/4" screws into any of the remaining Metal Ridge Board Connector's holes. Complete both sides. **Important:** if there is a gap between Ridge Boards, try pushing side walls closer together from outside. Walls should be 136 1/2" apart at top from inside of wall plate to wall plate.

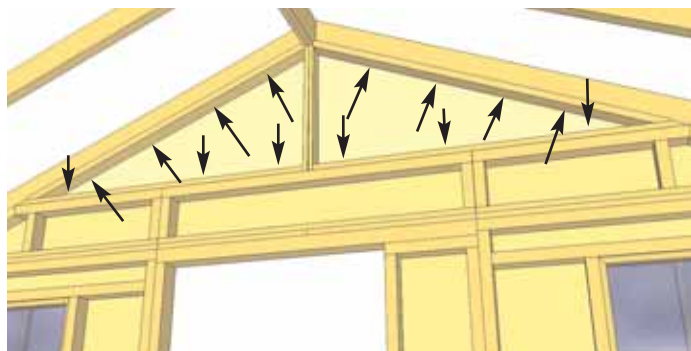
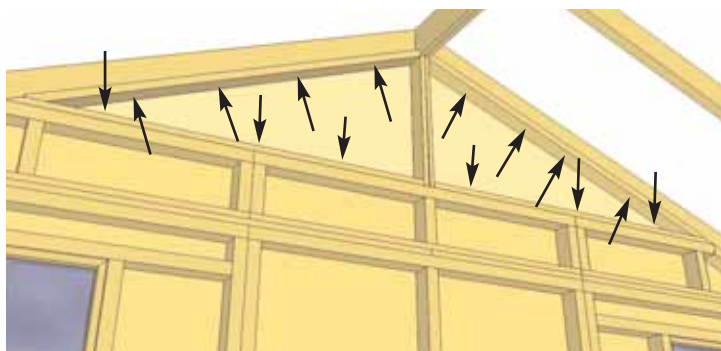
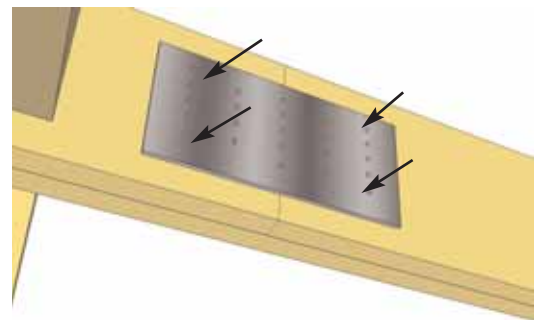

**44.** With both Rafters Sections correctly aligned, secure Gable framing to both outside rafters with 8 - 2" screws per side at top and with 6 additional 2" screws into wall top plates at bottom.

**Important:** If Gable framing does not line up with Rafters, remove temporary 2" screws from gable framing. Re-align gable and secure with 8 - 2" screws total.

3/4" x 3 1/2" x 56 1/2" & 75" long - 2 pcs.

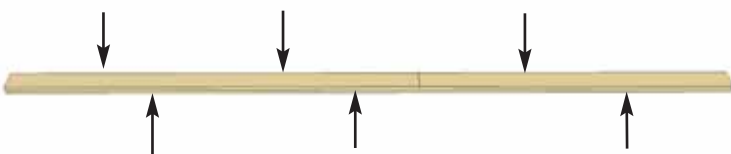

**45.** To increase the strength of rafters, assemble **Rafter Support Beam**. There are 2 pieces per side, 4 in total (56 1/2" and 75" long). Position a long and short piece so the total length is 131 1/2". Position 2nd pair of Supports on top of first, staggering the joint. Screw together with 6 - 1 1/4" screws. Lift Rafter Support Beam and place directly under Roof Ridge Board.

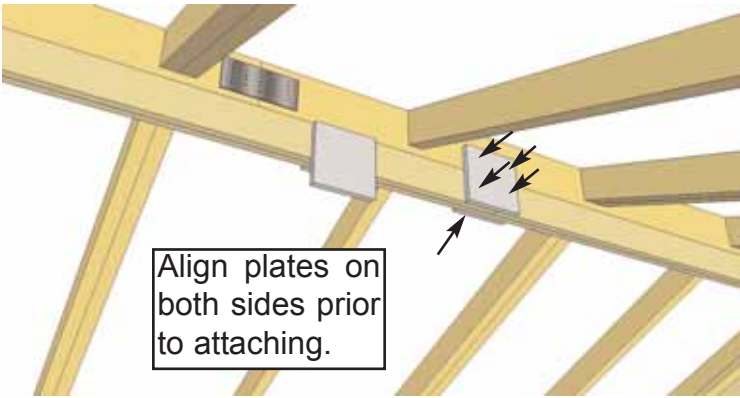

Align plates on both sides prior to attaching.

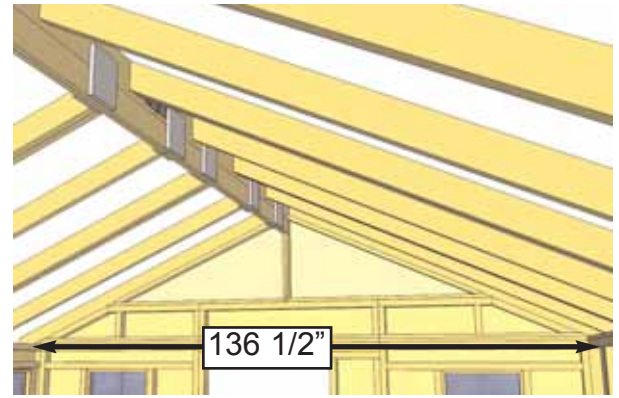

136 1/2"

**46.** Attach Support Beam to Ridge Board with 10 **Plywood Support Beam Connector Plates** using 4 - 2 1/2" screws per Plate. Complete 5 pairs, spacing evenly on Ridge Board.



Place 1" below top edge of rafter.

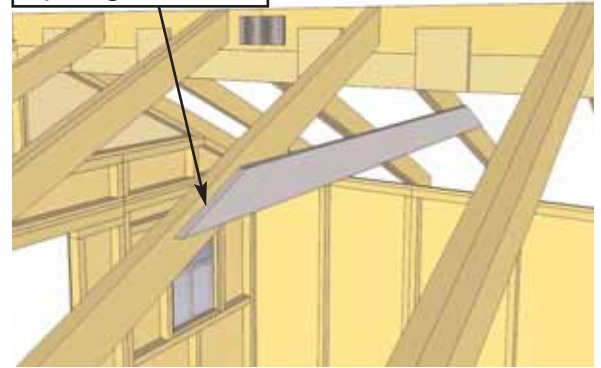

**47.** Prior to attaching **Gussets**, make sure walls are aligned correctly. Have two helpers push on both side walls at the top from the outside until wall side plates are **136 1/2"** apart from the **inside**. With walls correctly positioned, attach Gusset to Rafter with 4 - 2" screws per side. Use a level to check for square. Pilot hole end of Gusset to prevent splitting.

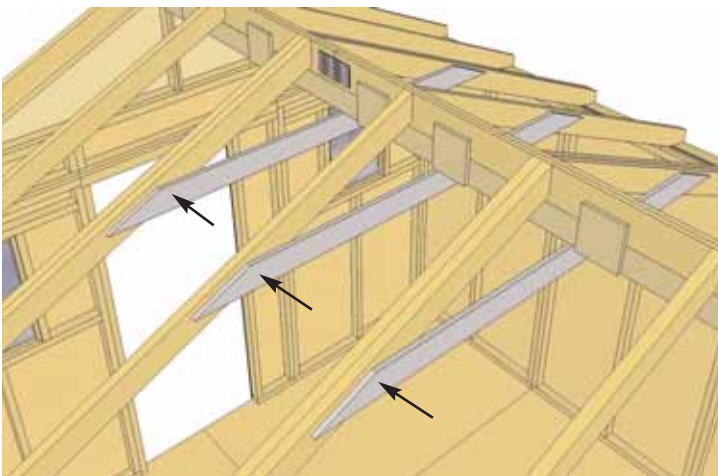

**48.** Complete all Gusset attachments as per **Step 47.**

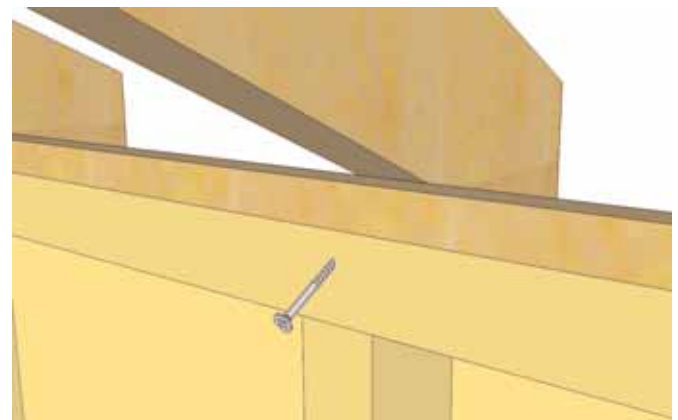

**49.** Secure Short and Long Rafters to Wall Framing with one 3" screw per rafter. Screw through Wall Frame at an angle.



**50.** Position a 3/4" x 3/4" x 48" long **Lexan Support Cleat** on each Long Rafter flush to end and recessed 1/4" down from top of rafter. Nail to rafter using 6 - finishing nails. **Note:** Start nails in Supports on ground first. Further secure with 2 - 1 1/4" screws - see diagram below. Complete remaining 11 Lexan Support Cleats.

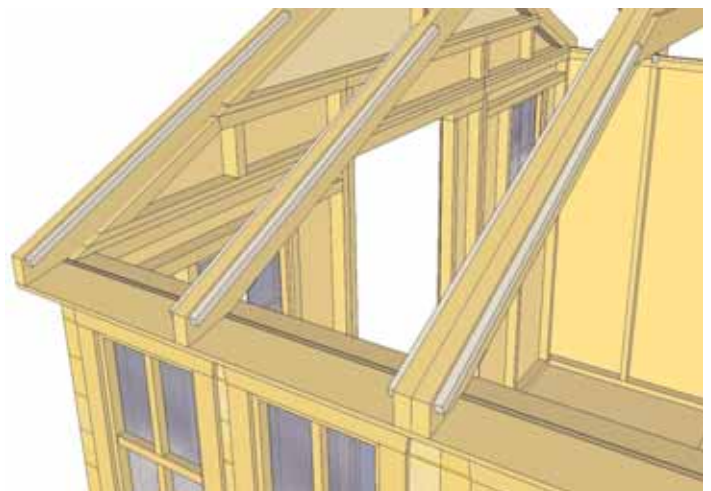
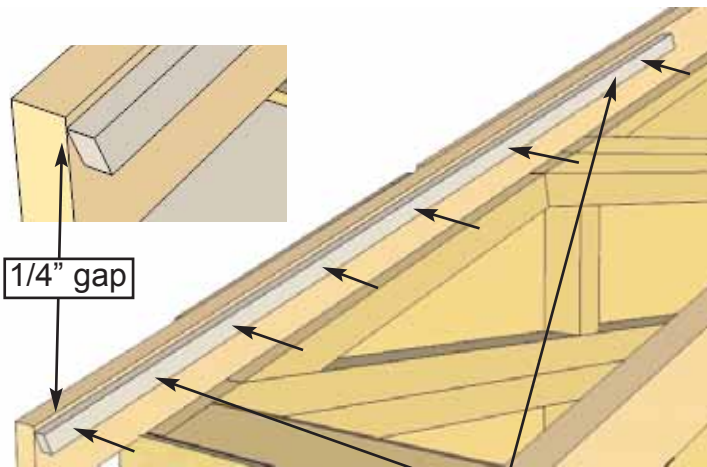

Further secure Cleats with 2 - 1 1/4" screws. **Important:** Drill pilot holes to prevent splitting!

**51.** Position **Triangular Gable Trims** (4) in each corner of exposed cavity of Gable Wall. Use 2 finishing nails each to secure into rafter.

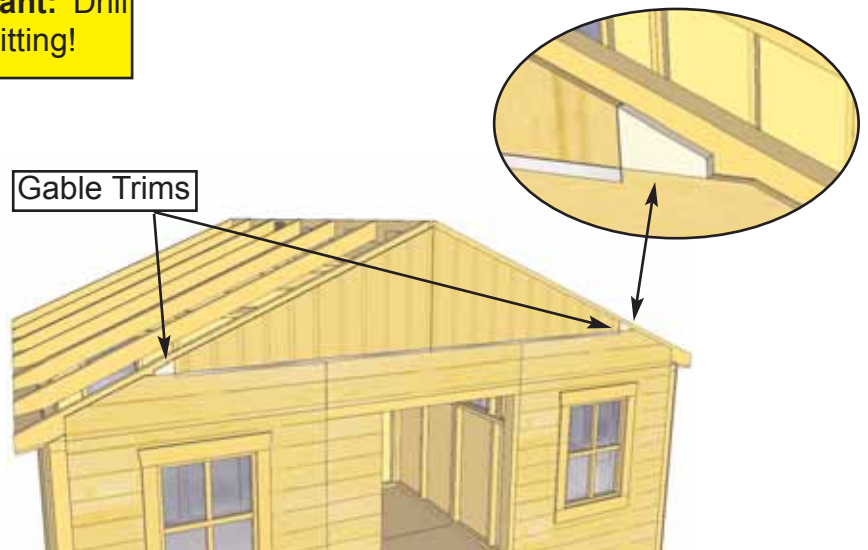

# Roof Section

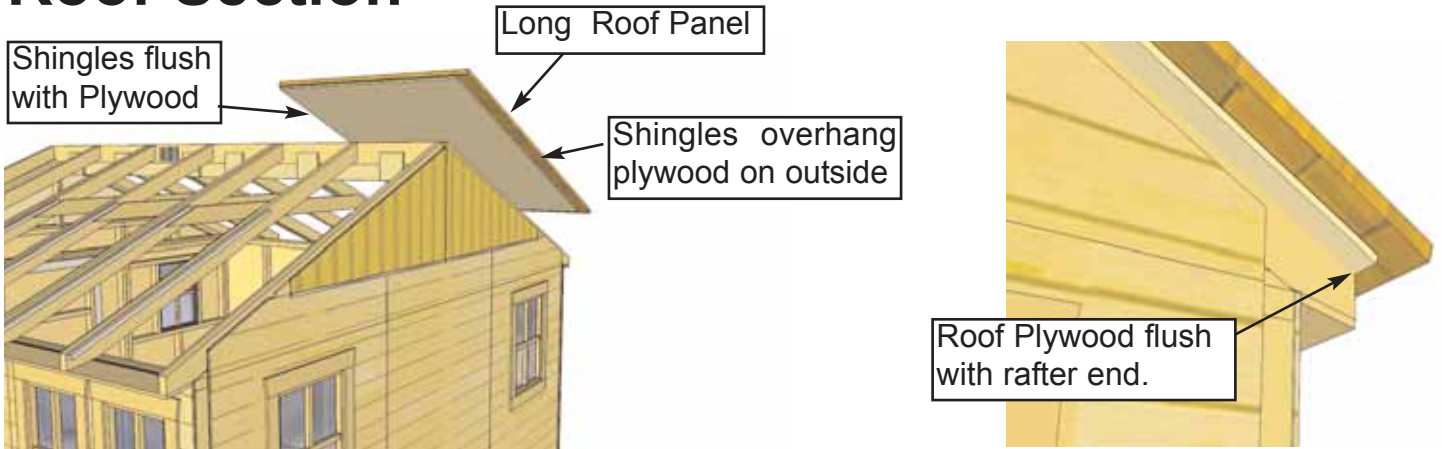

**52.** Identify all **Roof Panels**. There are 2 Outside Right, 2 Center and 2 Outside Left Roof Panels. The outside of the panels will have shingles overhanging the plywood. Starting with an Outside Long Cedar Shingle Roof Panel, lift up and place on rafters so Plywood is flush with end of Rafter.

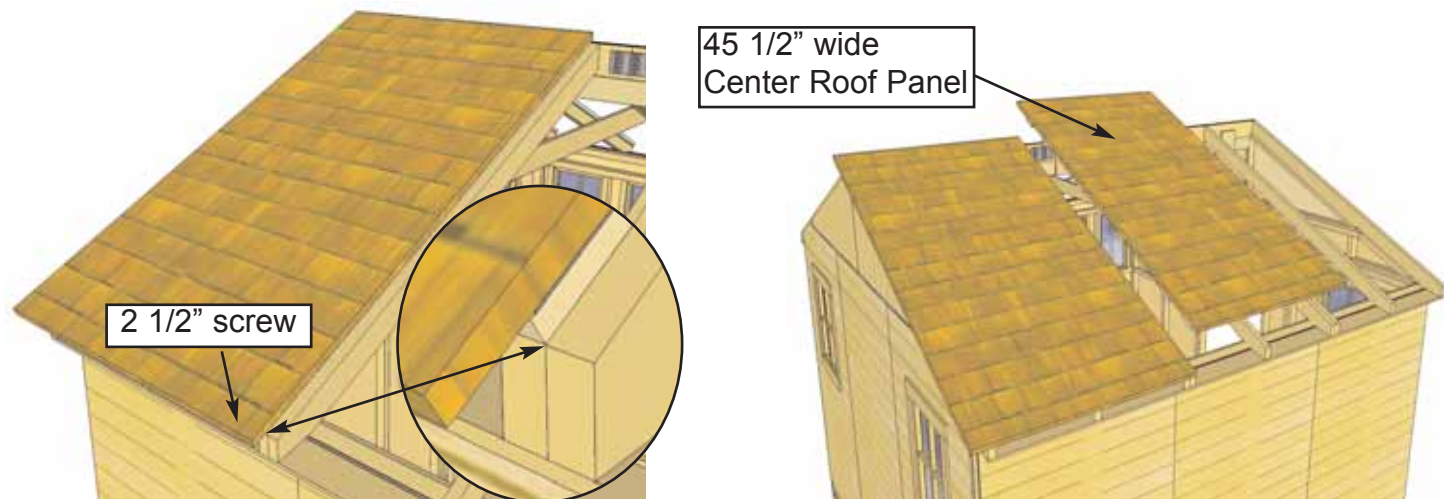

**53.** Position Panel so roof plywood sits evenly on doubled up Rafters. Screw Panel to Rafters through bottom row of shingles with 1 - 2 1/2" screw. Lift up and place a Long Center Roof Panel on Rafters. Center Panel will have plywood flush with shingles on both sides. Position evenly on Rafters.

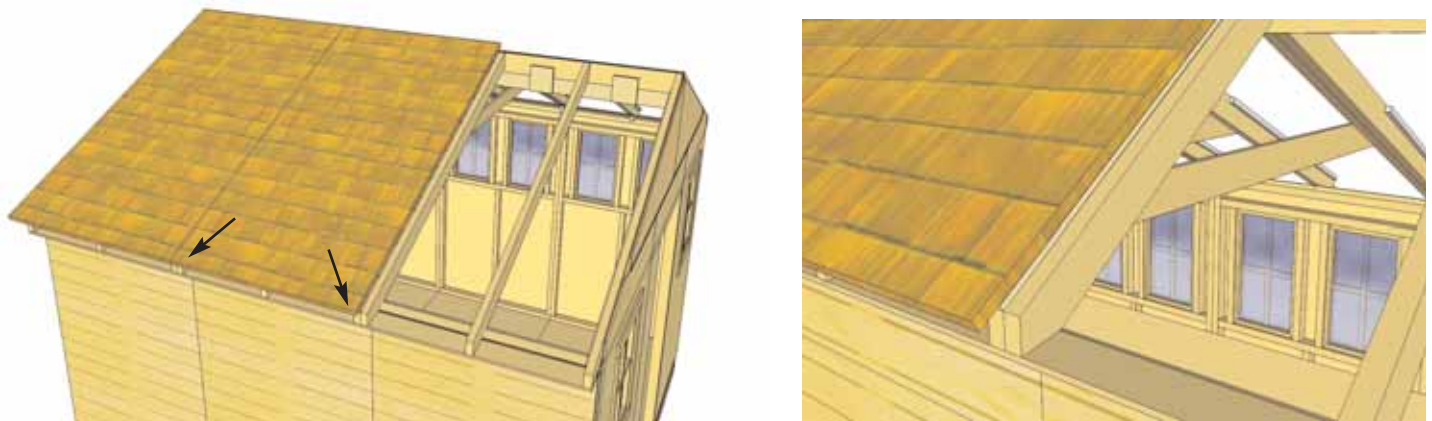

**54.** Position Center Roof Panel so plywood is flush with end of rafter as per **Step 52**. From side to side, make sure Roof Panel is sitting equally on rafters. When positioned correctly, screw down with 2 - 2 1/2" screws into outside lower shingles.

Shingles overhang  
plywood on outside



**55.** Lift up and place remaining Long Outside Roof Panel on rafters. Plywood on roof should be flush with end of rafter at bottom.

Lexan Side Short Roof Panel



**56.** With Outside Roof Panel centered on rafter and aligned as per **Step 52-53**, screw down with 1 - 2 1/2" screw. Lift and Place Outside Panel for Lexan Side Roof.

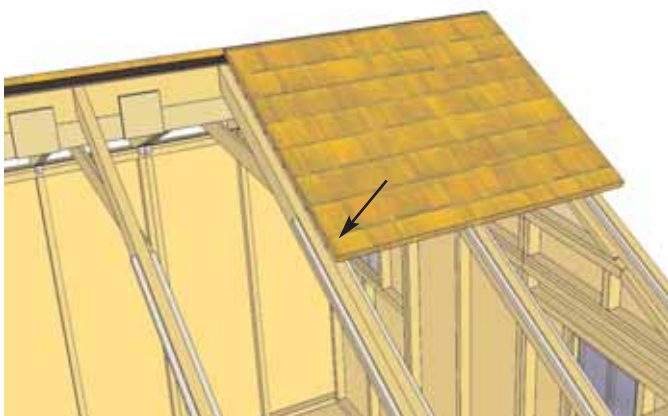

**57.** Position Outside Roof Panel equally on seam of doubled up rafters as per **Step 53**. Align Roof Panel at top so even with long panel at peak. Reach through opening in Rafters to attach. When positioned correctly, screw down with 1 - 2 1/2" screw in bottom row of shingles as illustrated above. **Hint:** work from inside of shed to position and secure Lexan Side Roof Panels.



**58.** Follow **Steps 53 - 56** for positioning and attaching Lexan Side Roof Panels. Align evenly at roof peak. Attach first outside panel with 1 - 2 1/2" screw.

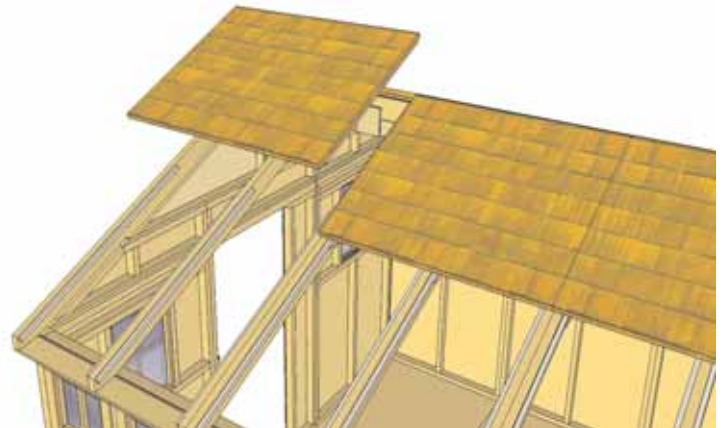
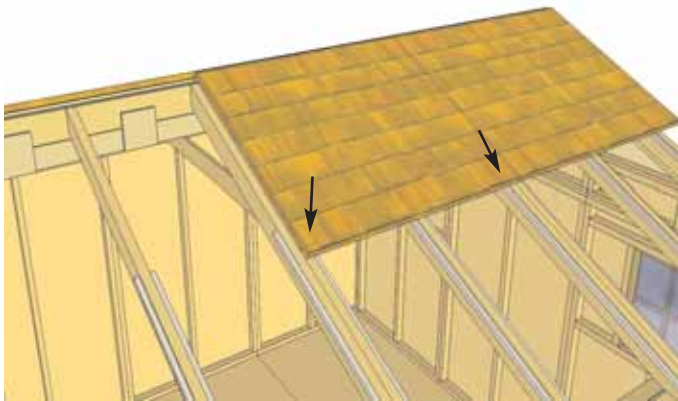
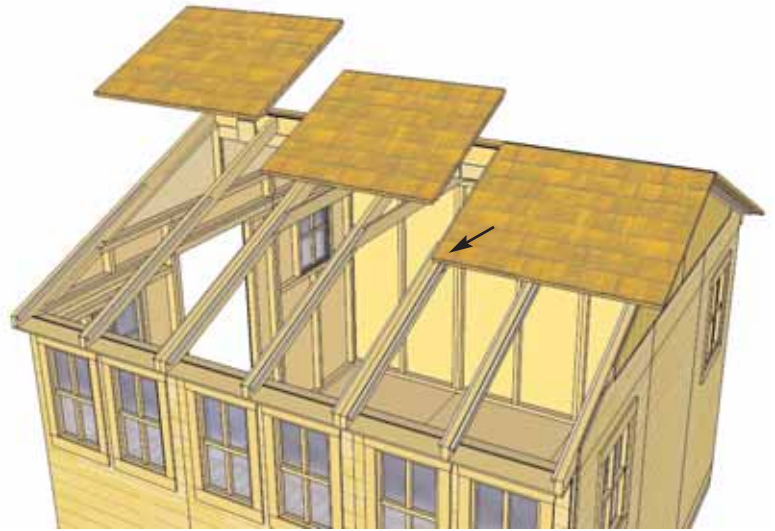

**59.** Work from inside the Sunshed when completing Lexan Side Roof Panels. Attach Center Panel with 2 - 2 1/2" screws as per **Steps 54**. Place remaining Outside Roof Panel into position.

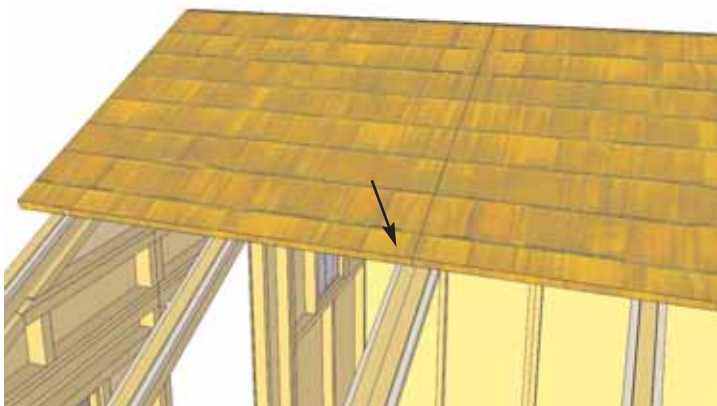

Completed Lexan Side Roof Panels



**60.** Position and attach Outside Panel.



**61.** Next, time to install **Filler Shingles** to hide roof seams of shed. Starting at bottom on Short Roof Side, push a Long Filler Shingle underneath shingles directly above it until ends are flush.

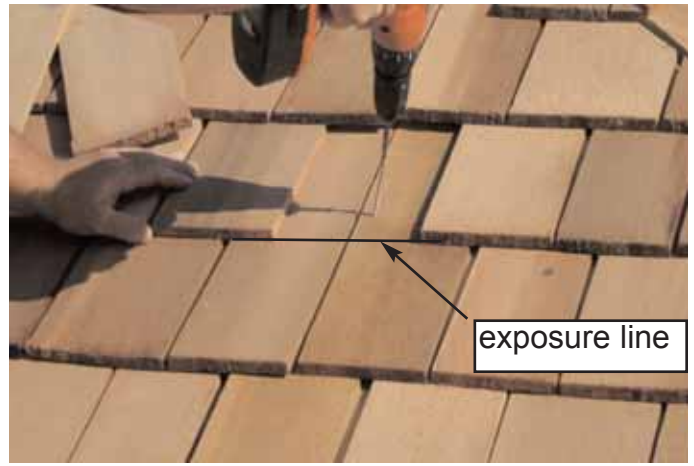

**62.** Screw first filler shingle down to rafters above the exposure line, using 1 - 2 1/2" screw per panel (2 in total). Make sure to screw into both rafters.



**63.** Slide in the next Long Filler shingle and attach as per **Step 62**. At the top, use shorter shingle to fit. Attach top shingle to roof with 2 shingle nails. Complete for all seams on Short and Long Roofs.

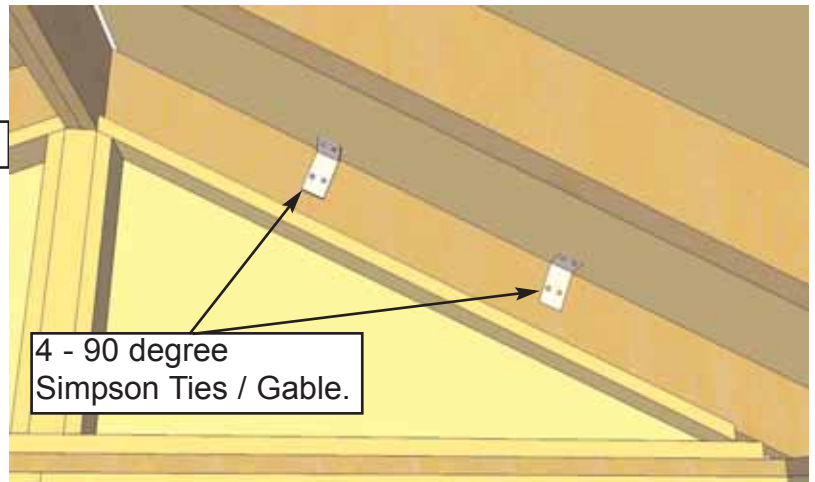

**64.** Position 2 Simpson Strong ties on plywood and outside rafters and secure with 4 - 1 1/4" screws. There are 4 ties per gable, 8 ties in total.

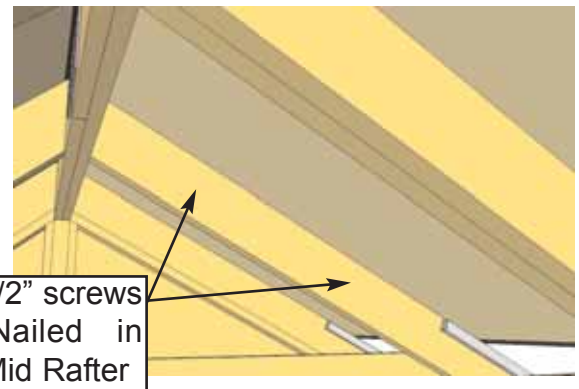
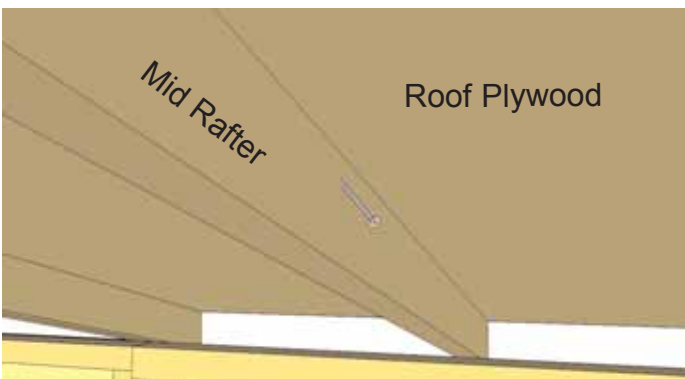

**65.** To further secure roof panels, from the inside, drill pilot holes on an angle into each Mid Rafter (3 per Rafter on Long Roof Side and 2 on Short Roof Side). Using 2 1/2" screws, secure rafters to roof plywood. **Hint:** have a helper push the roof panel down from the outside so plywood sits flush against the rafter when securing.

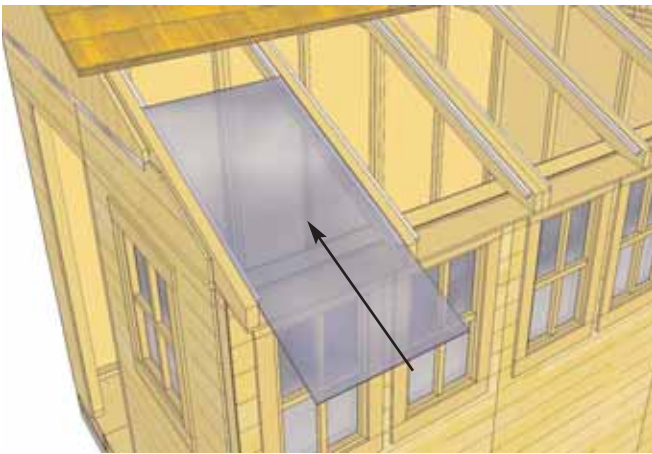

**66.** Installation of **6 Polygal Panels** is next. Start by removing protective plastic layer on each panel. Exterior/interior side of protective polygal film is printed on film, be sure to note the side and install accordingly. Slide panel up between rafters so it rests on Polygal Support Cleats. From the inside, carefully slide end of panel underneath shingles.

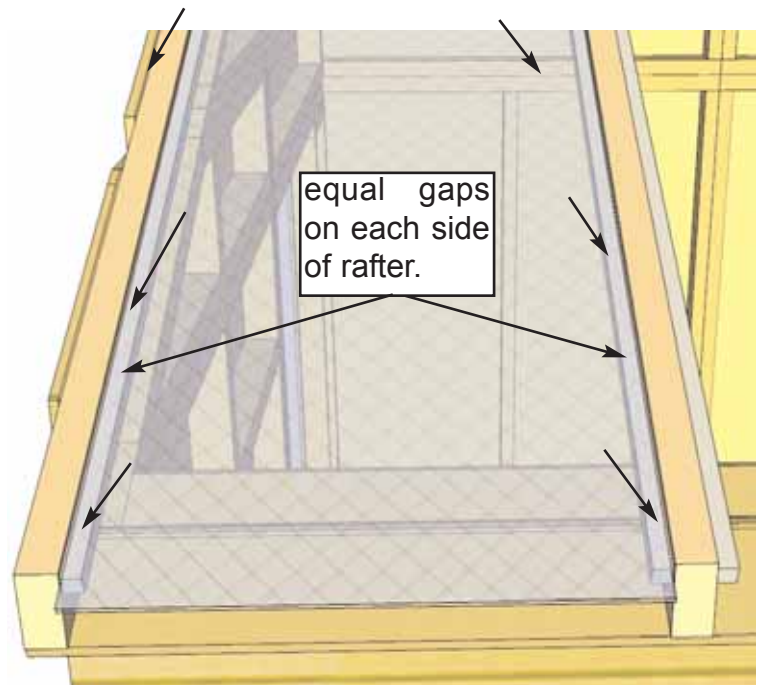

**67.** Position Polygal Panel with equal gaps between rafters and overhanging the end of rafters by 1". With 6 - 1 1/4" nails, secure panel to Polygal Support Cleats.



**68.** Use 3 finishing nails to secure Polycal Panel to underside of roof plywood.



**69.** Complete installation of remaining Polygal Panels as per **Steps 66 - 68.**

**70.** With a Caulking Gun, apply Silicon down each side of rafter to seal gaps between rafters and Polygal Panels. Use liberal amounts to properly seal the joint.

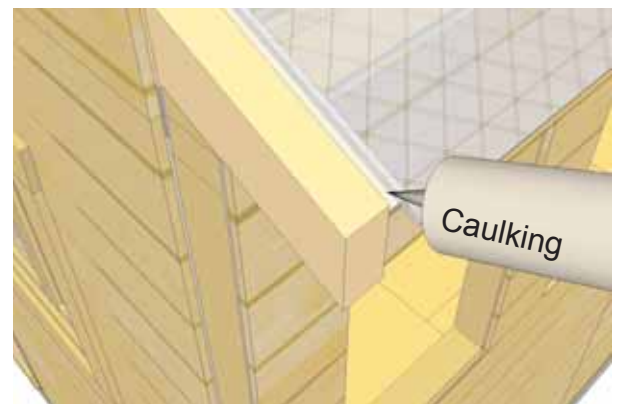

# D. Miscellaneous Section

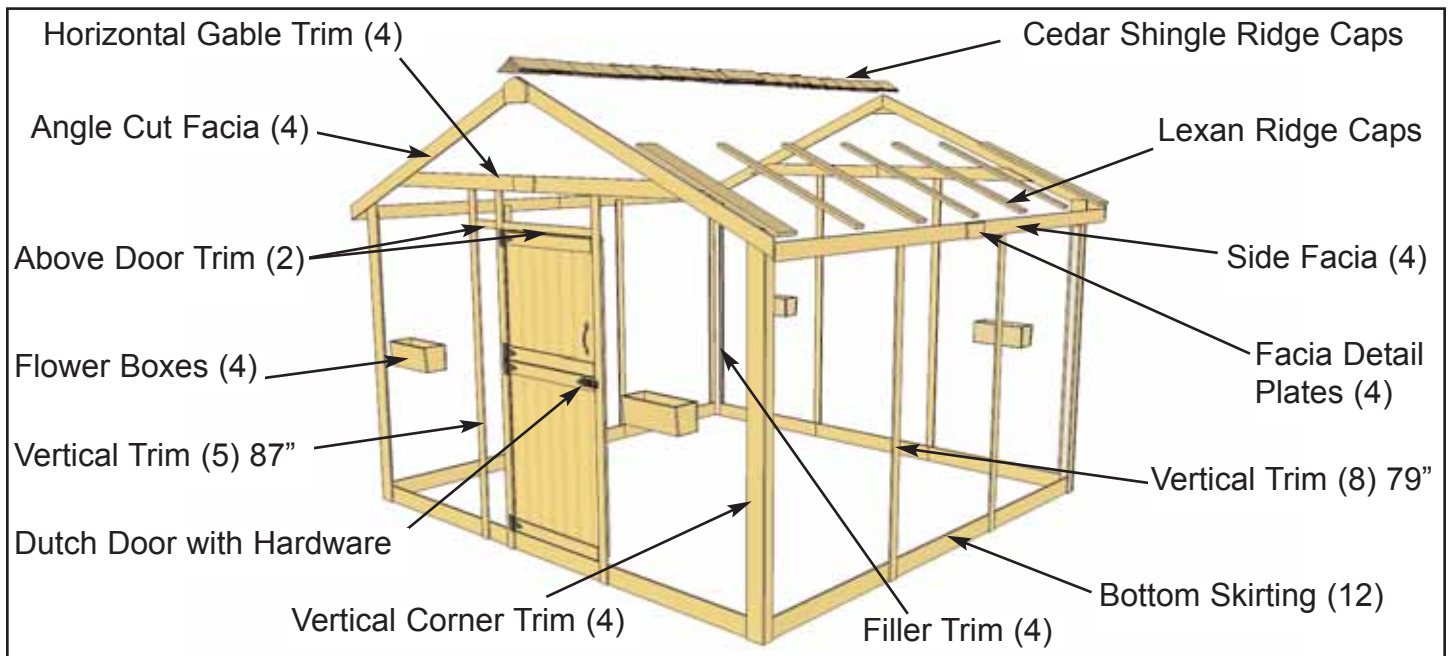

**Expert Advice:** When installing trim, sort pieces according to color and pieces that are most pleasing to the eye. Start with least visible side and use the least desirable pieces first. Install trim to most visible sides as your skill installing trim improves.

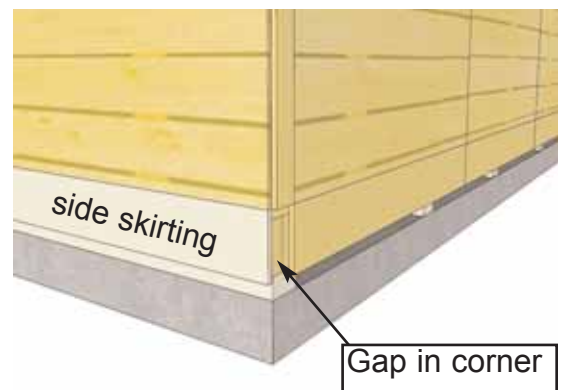

**71.** Attach **Bottom Skirting** around the base of the shed. Skirting will hide floor framing. Gaps on outside will be covered by Wide Trim pieces later. Start with front and rear skirting pieces first and attach with 4 - 1 1/2" finishing nails per piece.

**72.** Position **2 Door Trims** (2 - 1/2" x 2 1/2" x 87") on each side of door opening. Right side will sit flush with Door Jamb. Left side will sit flush on edge of Narrow wall. Do a dry run with the Horizontal Gable Trim (**Step 90**) to determine vertical location of Trims. Attach with 8 - 1 1/2" finishing nails.

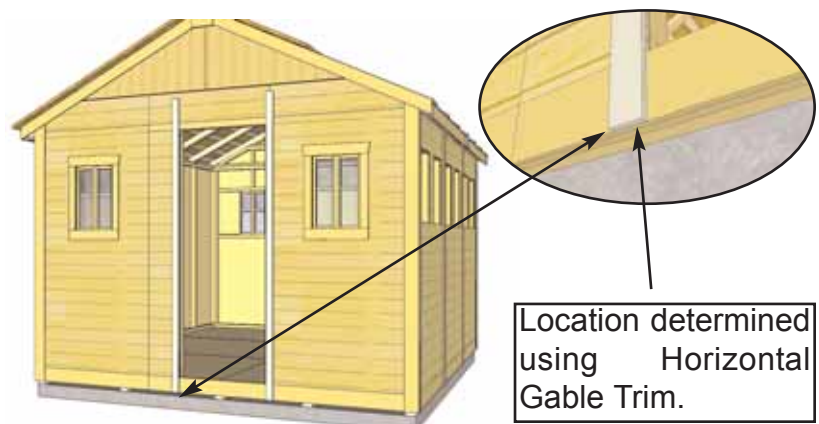

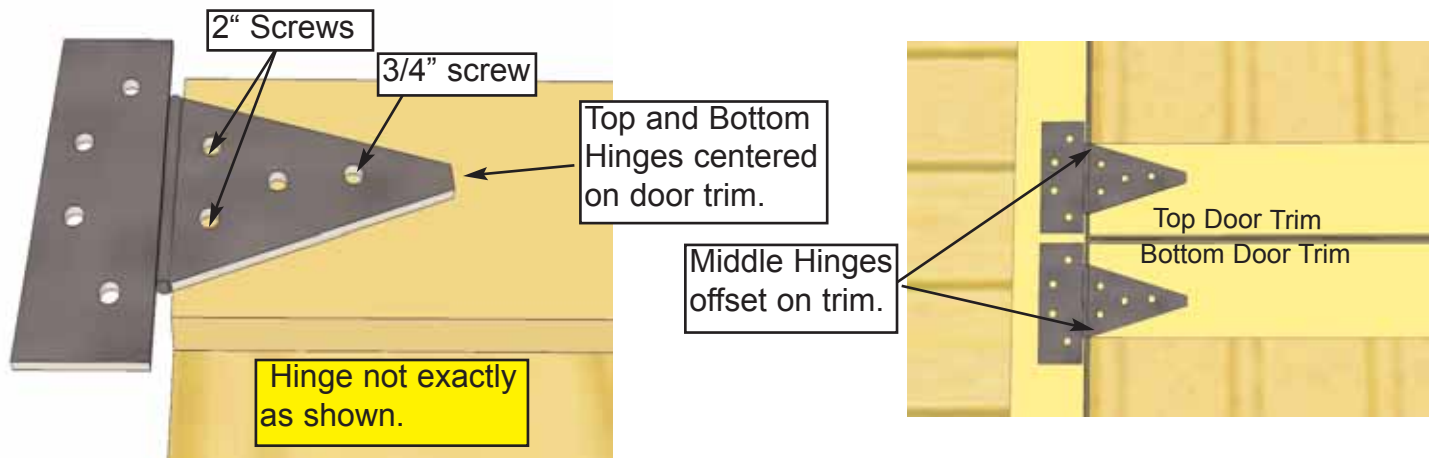

**73.** Attach Door Hinges to **Top** and **Bottom Dutch Door** sections. Middle Hinges should be positioned to edge of door trim to prevent hinges from contacting each other, while top and bottom hinges may be centered on door trim. Use 2" & 3/4" black screws as shown above.

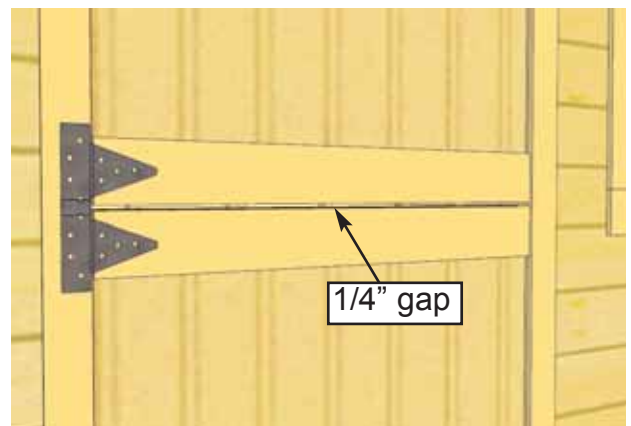
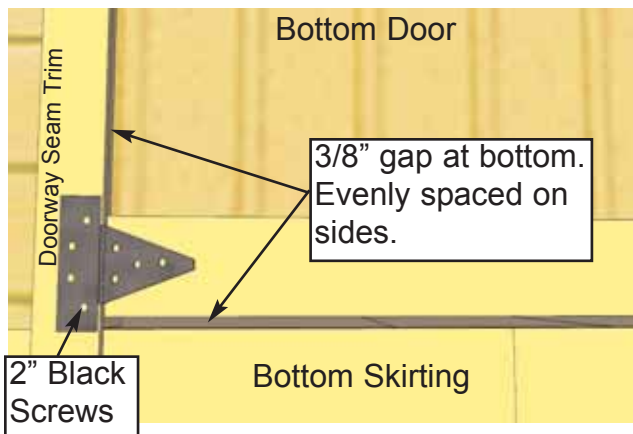

**74.** Place Bottom Dutch Door panel into position. Gap 3/8" on bottom, evenly space on sides, and attach hinge to doorway seam trim with 2" black screws. Use shim to help keep the door evenly spaced on bottom. One of the extra roof shingles (see parts list) can be used.

**75.** Place the Top Dutch Door Panel into place and gap top and bottom panel 1/4" apart. Use a shim once again to help you. Attach hinges to trim with hinge hardware provided.



Temporarily position Interior Door Stop to help align Interior Barrel Bolt.

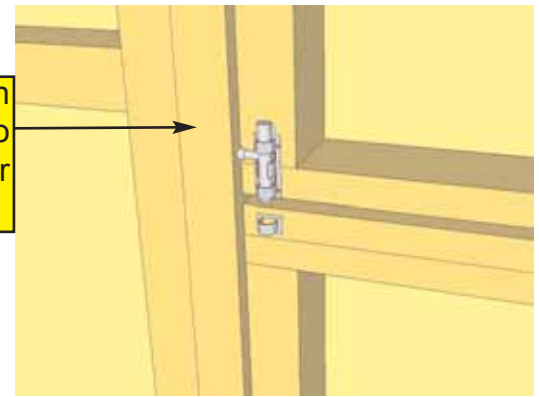

**76.** Attach **Door Handle**, **Exterior Barrel Bolt** and **Interior Barrel Bolt** to door. Handle is positioned on top door, Barrel Bolt on bottom door, and Interior Barrel Bolt (silver) on top door stud. Attach Black Barrel Bolt as illustrated above with 3/4" Black Screws. Note how female part of Barrel Bolt is positioned higher than male part. Do a dry run first to position Barrel Bolt correctly. **Important:** Drill pilot holes with 1/8" drill bit prior to securing to prevent wood from splitting.

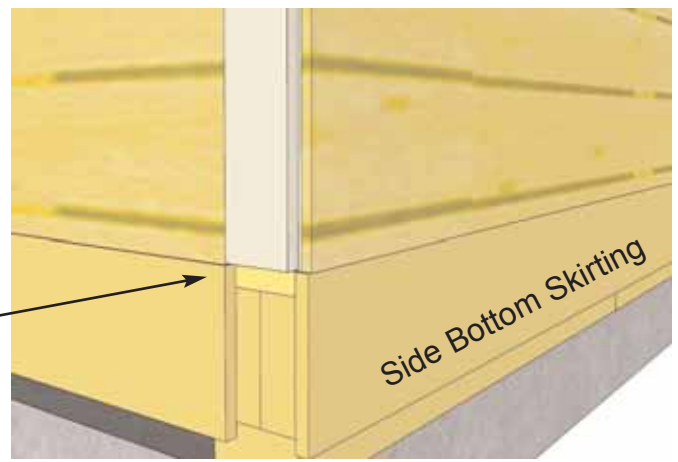

**77.** Attach **Filler Trim** (4 - 1/2" x 2 1/2" x 75") to front and rear walls in each corner. Attach with 8 - 1 1/2" finishing nails. Strips are positioned flush with siding and bottom skirting.

**78.** Attach **Wide Corner Trim** and **Narrow Trim** in each corner. Wide Trims are 4 1/2" wide, Narrow Trims are 2 1/2" wide. Begin with narrow trim on side of shed, aligning tight underneath Soffit and even with front of filler trim. Wide Trim will cap Narrow, as shown in **Step 79**. **Note that trim may sit slightly below Bottom skirting when correctly aligned.**

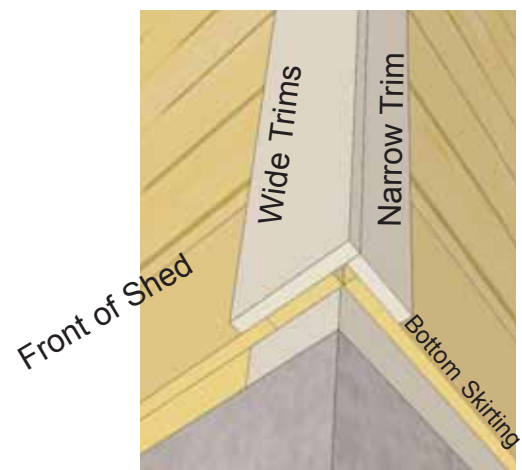

**79.** When correctly aligned, attach with 8 - 1 1/2" finishing nails per piece. Complete remaining Corner Trim attachments.



**80.** Attach **Narrow Wall Trims** around the Sunshed. Narrow trims are used where wall panels come together and leave a seam. **Note:** the Narrow Trim on the Short Wall side is only 79" long. Attach with 8 - 1 1/2" finishing nails per piece.

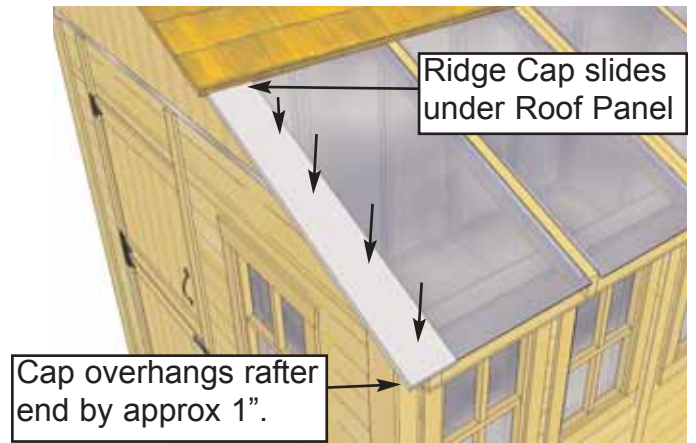
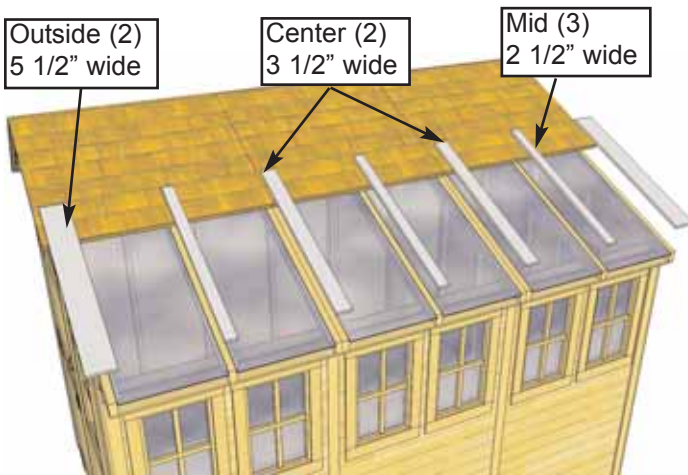

**81.** Locate all **Ridge Caps** for Polygal (3 Mid / 2 Outside / 2 Center). Starting from the outsides, position both 5 1/2" wide caps so outside edge is aligned with plywood of roof, and Cap end slides under roof. When correctly aligned, attach Caps to center of outside rafter with 4 finishing nails. Use a straight edge to align Cap with Roof Plywood. **See below.**

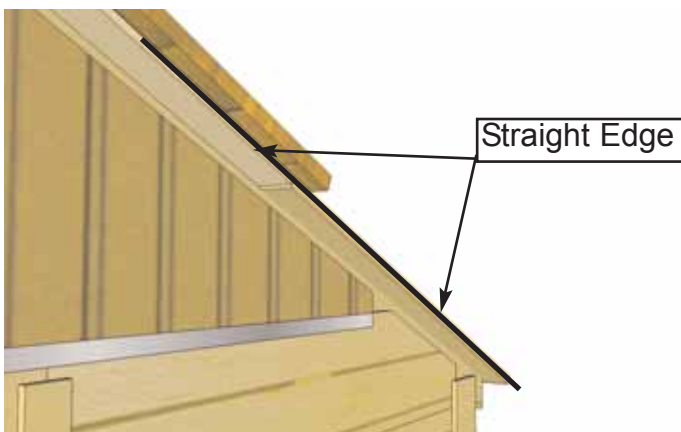

**82.** Position and attach Mid Ridge Caps, evenly spaced on mid rafters. Align top to bottom as per **Step 81.**

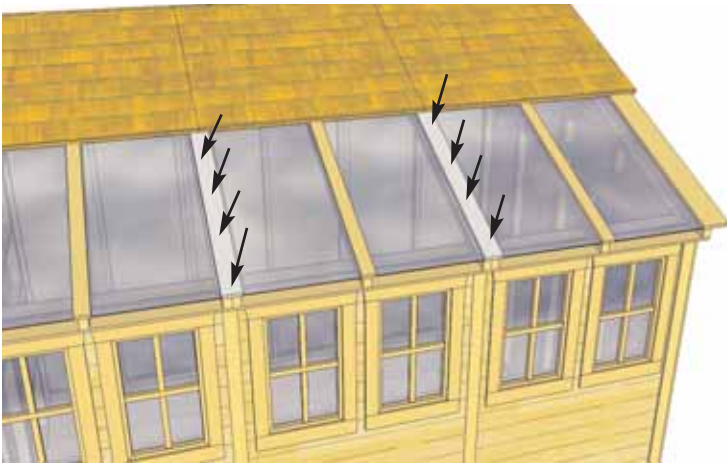

**83.** Align and attach remaining Ridge Caps (3 1/2" wide) over Double Rafters as per **Step 81**.



Do a dry run, lining up Front/Rear/Side Fascia to confirm positioning prior to attaching.



**84.** Attach **Front** and **Rear Fascia** (angle cut on ends), to end of roof plywood on Long Roof Side, with 10 1/2" finishing nails. Line up the 82 1/8" long Fascia piece so Fascia end lines up with Plywood and Rafter ends.

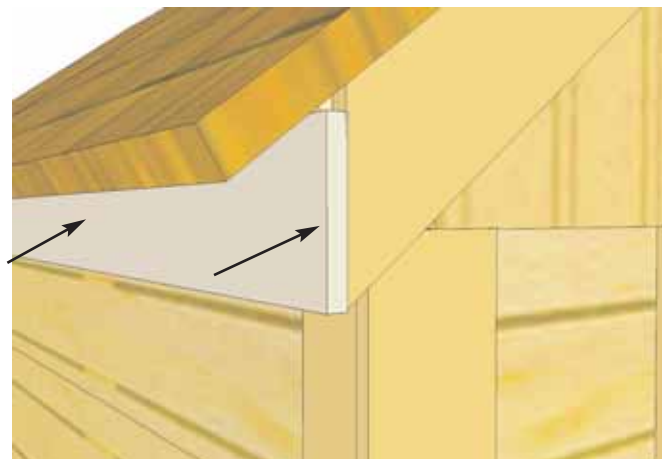

**85.** Attach **Side Fascia** to roof rafter ends. There are 2 Side Fascia pieces per side. Secure with 8 - 1/2" finishing nails per piece. Side Fascia will sandwich Front and Rear Fascia.



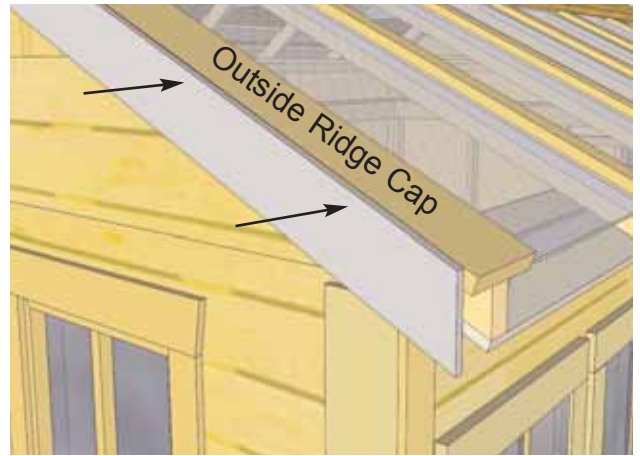

**86.** Attach remaining front and rear 82 1/8" long Facia boards to roof plywood and Outside Ridge Cap edge with 10 - 1 1/2" finishing nails and 2 - 1 1/4" screws. Use screws where Outside Ridge Cap and Facia meet. Once again, Line Facia up so it is aligned with rafter ends. Do a dry run with Front and Rear and Side Facia to confirm correct positioning prior to attaching.

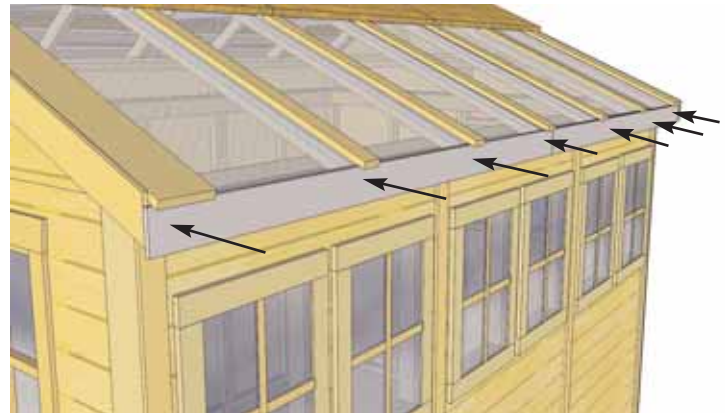
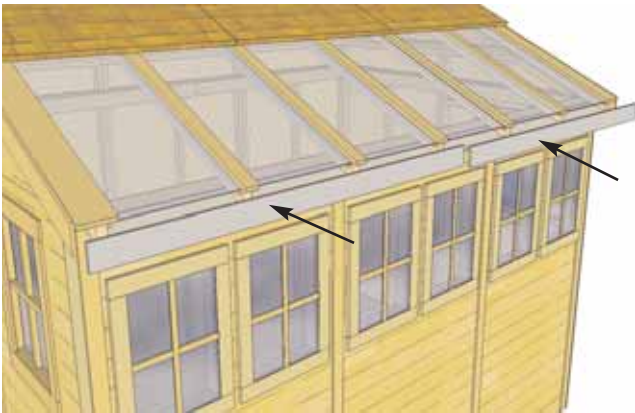

**87.** Attach remaining **Side Facia** to roof rafter ends as per **Step 85**.

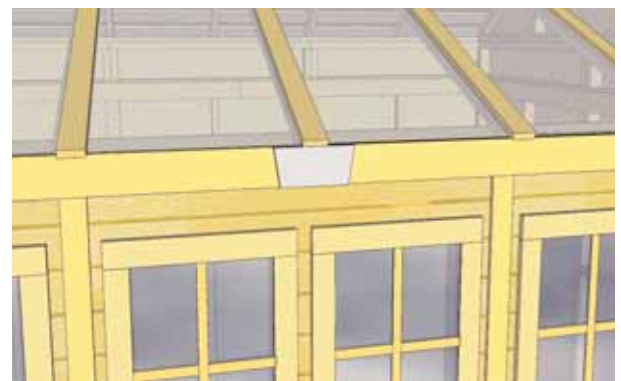

**88.** Attach **Facia/Trim Detail Plates and Pentagon Plates** to cover seams where Facia Trim pieces come together. Secure each with 4 - 1 1/2" finishing nails.



**89.** Attach both the **Horizontal Door Trim (32")** and **Horizontal Narrow Wall Trim (8")** with 4 and 2 - finishing nails.



**90.** Locate **Horizontal Gable Trims** for both front and rear of shed. Position equally over gable and wall seam.

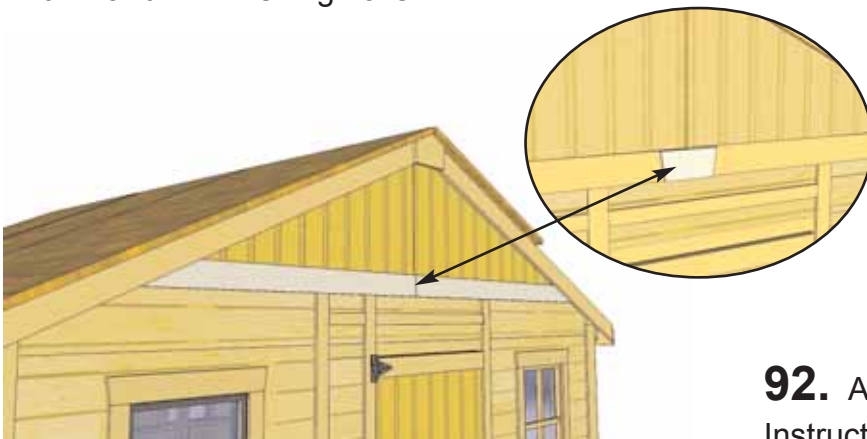

**91.** Use 8 - 1 1/4" finishing nails per piece to secure. Complete Rear. Attach **Facia Detail Plates** over Horizontal Gable Trim seam and attach with 4 - 1 1/2" finishing nails.



**92.** Assemble **Flower Box Kit** with Assembly Instructions included. Position completed Flower Box below bottom of window trim and secure with 2 - 2 1/2" screws. Screw from inside of box into the center wall stud. Attach second screw 2" underneath first screw and once again into the wall stud. Install Flower Box Kits underneath each window.

Alternate Ridge Cap Seams  
(Offsetting angle cut at peak)

**Important-**  
Butt (thick) end of Ridge Cap will be facing towards the outside of shed.

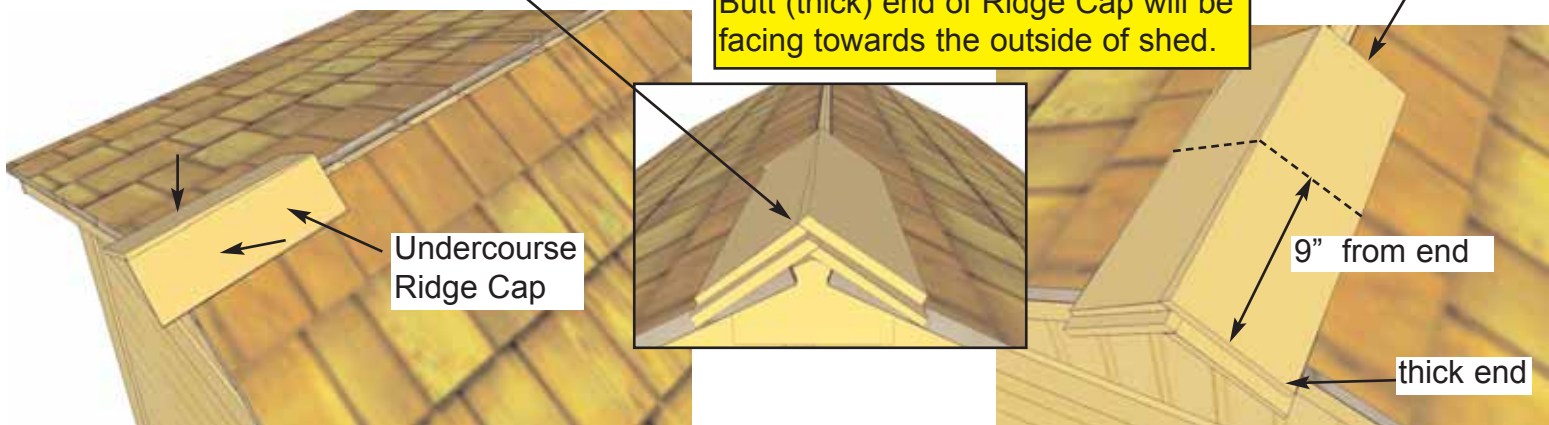

**93.** Place First Roof Ridge Cap (Lower Grade Undercourse Ridge Cap) on roof peak overhanging shingles by approximately 1". Attach with 2- 1 1/4" Shingle Nails 9" from end. Place 2nd Ridge Cap 1" back from 1st cap. Attach with 2- 1 1/4" Shingle Nails 9" from end. Alternate each Ridge Cap as you proceed.

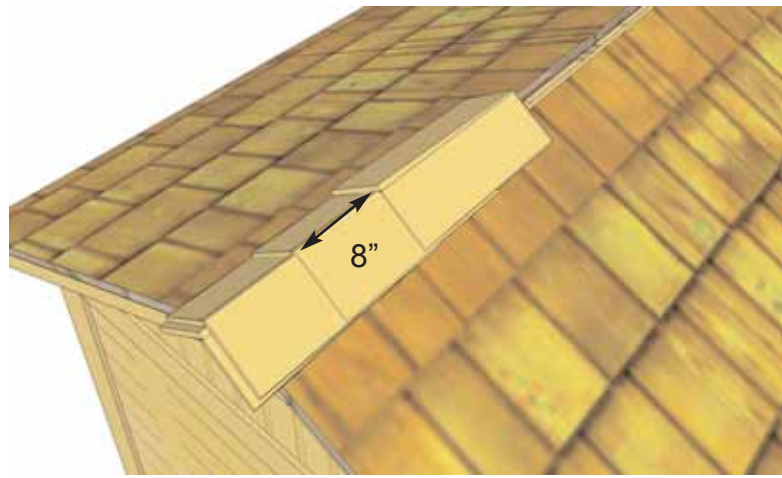
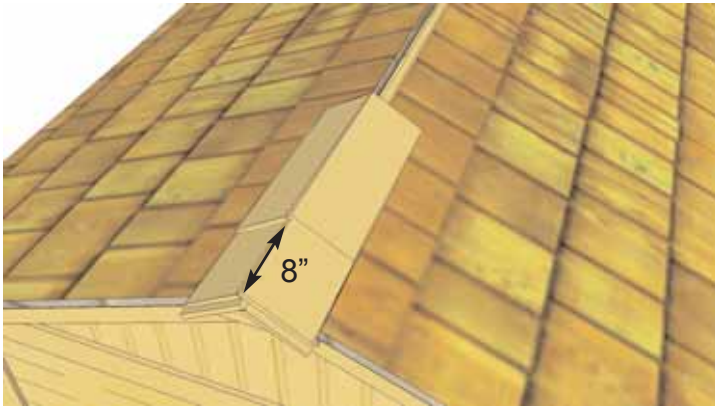

**94.** Place 3rd Ridge Cap 8" back from 2nd. (enough to cover shingle nails). Attach 3rd Ridge Cap down as per **Step 95**. Continue to position and attach Ridge Caps until half roof is complete.

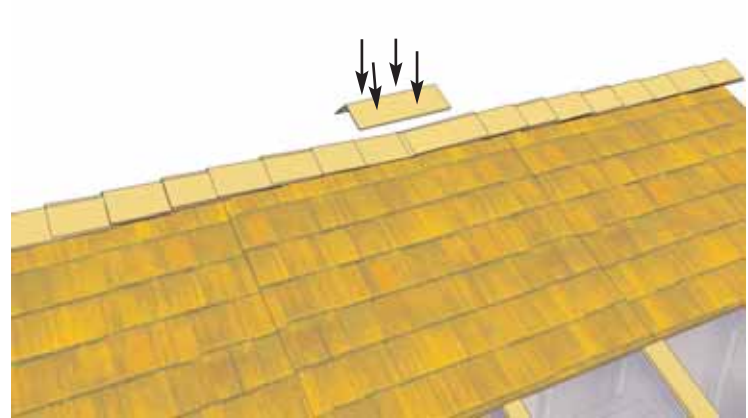
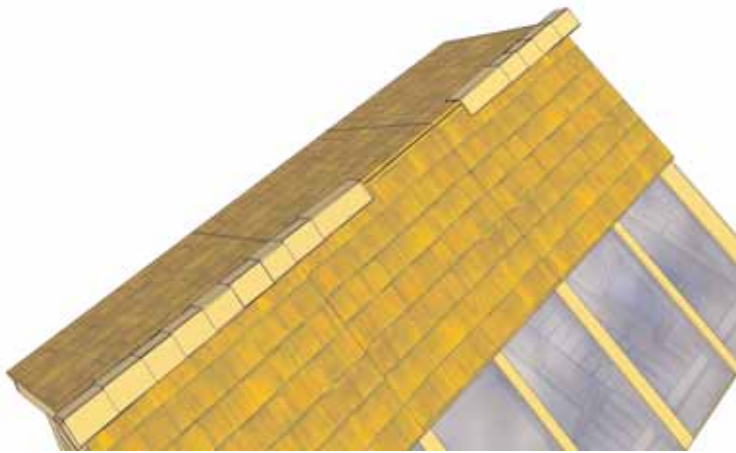

**95.** From opposite side, position and attach Ridge Caps as described above starting with the Undercourse Ridge Cap. Score/cut 1 Ridge Cap to 12" or to fit in the center of roof. Attach center cap with 4 - 1 1/2" Shingle Nails.

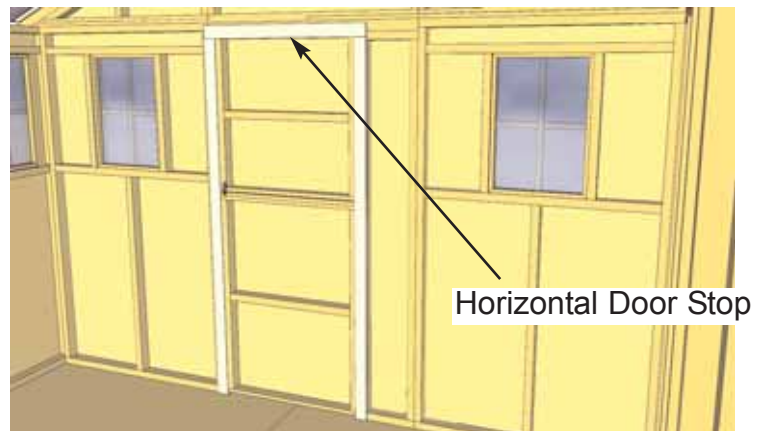
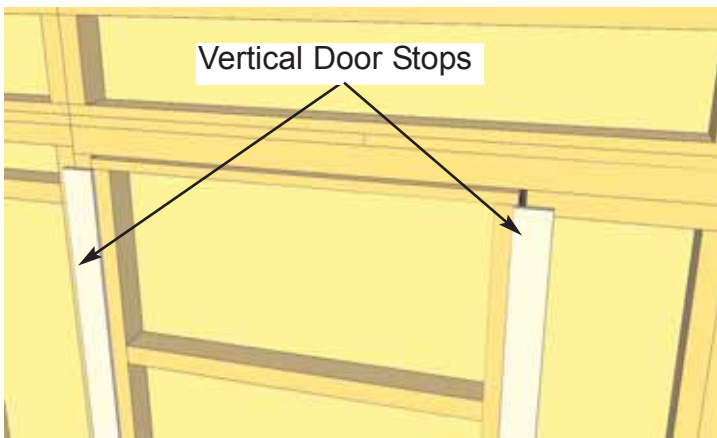

**96.** Attach Interior **Vertical and Horizontal Door Stops** to door framing from inside of shed. Use 4 - 2" screws to secure each Stop. Stops should overlap door by approx. 1/2"

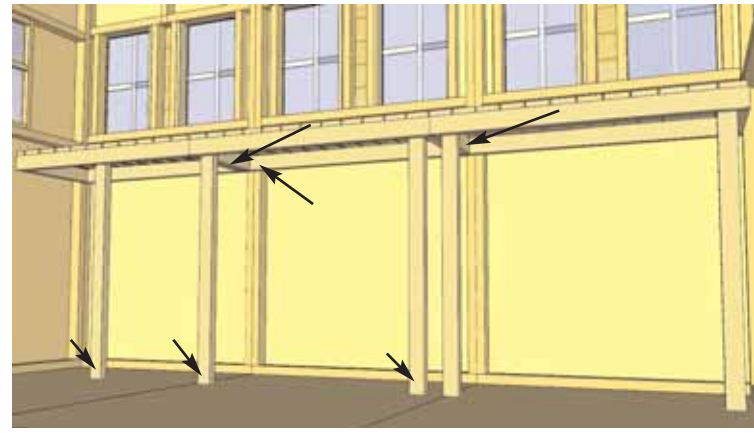
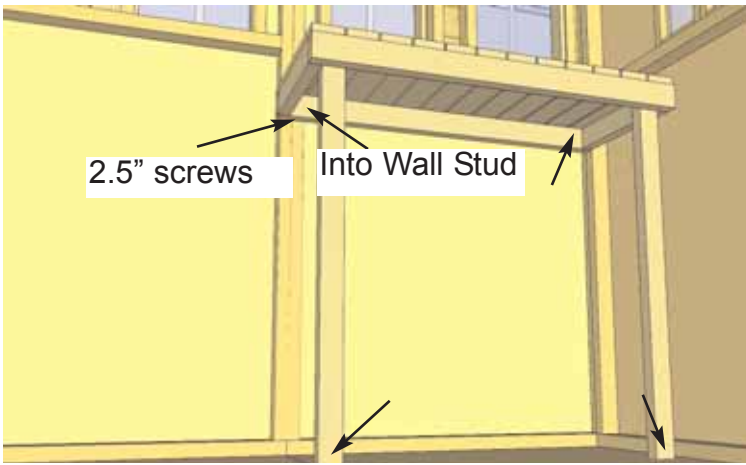

**97.** Locate 1 **Long Potting Shelf** and 2 Legs. Attach Legs in each front corner from the inside with 2 - 2.5" screws. Attach Shelf framing to wall studs with 2 - 2.5" screws. Place 2nd Long Potting Shelf and 2 Legs adjacent to Long Potting Shelf and attach together from underneath where end framings meet with 2 - 2.5" screws. Attach Long Shelf into Wall Stud with 1 - 2.5" screw from underneath. Place Short Potting Bench in corner and attach end framings together and also to wall studs with 4 - 2.5" screws. Attach 1 front center Leg.

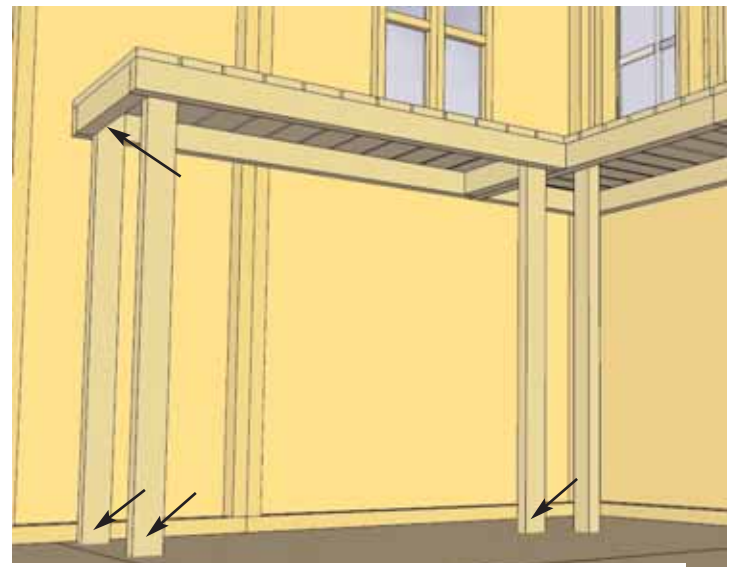
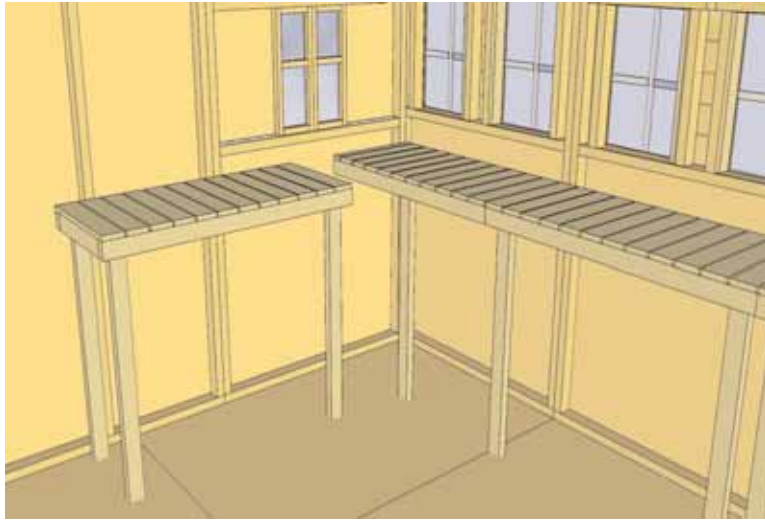

**98.** Locate 3rd Long Potting Shelf and 3 Legs. Attach Legs in front corners and outside rear corner with 2 - 2.5" screws/leg from underneath. Place in rear corner against Short Potting Shelf and attach together from underneath where framings meet with 2 - 2.5" screws. Attach Long Shelf into Wall Stud with 1 - 2.5" screw from underneath.

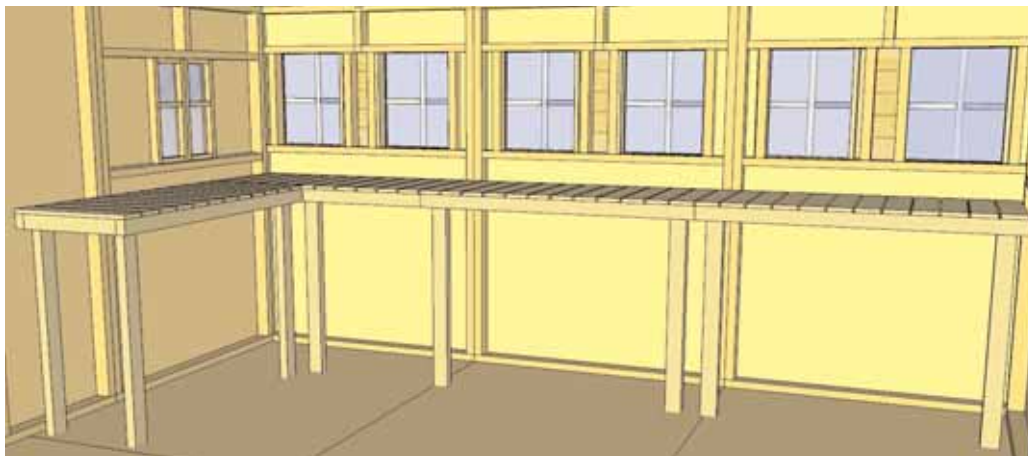

Completed  
Potting Shelf  
Setup.



**Note;** Our Sheds are shipped as an unfinished product. If exposed to the elements, the western red cedar lumber will weather to a silvery-gray color. If you prefer to keep the cedar lumber looking closer to the original color, we suggest that you treat the wood with a good oil base wood stain. You may also wish to paint your new shed rather than stain it. In both cases we recommend that you consult with a paint and stain dealer in your area for their recommendations.

We hope your experience constructing our building has been both positive and rewarding.

We value your feedback and would like to hear back from you on how well we are doing in the following areas:

- 1. Customer Service**
- 2. On Time Shipping**
- 3. Motor Freight Delivery**
- 4. Quality of Materials**
- 5. Assembly Manual**
- 6. Overall Satisfaction.**



The materials contained in this Assembly Manual may be downloaded or copied provided that ALL copies retain the copyright and any other proprietary notices contained on the materials. No material may be modified, edited or taken out of context such that its use creates a false or misleading statement or impression as to the positions, statements or actions.

Please call, write or email us at:

**Outdoor Living Today**

Canadian Address  
9393 287th Street  
Maple Ridge, British Columbia  
Canada V2W 1L1

United States Address  
P.O. Box 96  
Sumas, Washington  
USA 98295