

TPI Corporation

www.tpicorp.com

America's Comfort Conditioning Company



Raywall Redd-i



Markel Products Company

HEATERS

CONTROLS



Scan & View On Your
Smartphone Or Portable Device.
(PDF File)



Scan with RedLaser



www.facebook.com/tpicorporation



[@tpicorporation](https://twitter.com/tpicorporation)

PH: 1-800-682-3398 / 1-423-477-4131 | FAX: 1-423-477-0064

ELECTRIC HEAT, CONTROLS, & THERMOSTATS

INDUSTRIAL - COMMERCIAL - RESIDENTIAL

© Copyright 2014; TPI Corporation, P.O. Box 4973, Johnson City, TN 37602
January 1, 2014; Distribution Products Catalog Revision: 010114-001

Amperage Chart & Electric Heat Products Limited Warranty

K.W Rating	B.T.U.H.	208 Volt AMP Rating		220 Volt AMP Rating		230 Volt AMP Rating		240 Volt AMP Rating		277 Volt AMP Rating	440 Volt AMP Rating	480 Volt AMP Rating	550 Volt AMP Rating
		1 PH	3 PH	1 PH	3 PH	1 PH	3 PH	1 PH	3 PH	1 PH	3 PH	3 PH	3 PH
00.5	1,706	2.4	1.4	2.3	1.3	2.2	1.3	2.1	1.2	1.8	0.6	0.6	0.5
01.0	3,413	4.8	2.8	4.5	2.6	4.3	2.5	4.2	2.4	3.6	1.3	1.2	1.0
02.0	6,826	9.6	5.5	9.1	5.2	8.7	5.0	8.3	4.8	7.2	2.6	2.4	2.1
03.0	10,239	14.4	8.3	13.6	7.9	13.0	7.5	12.5	7.2	10.8	3.9	3.6	3.1
04.0	13,652	19.2	11.1	18.2	10.4	17.5	10.1	16.6	9.6	14.4	5.2	4.8	4.2
05.0	17,065	24.0	13.8	22.7	13.1	21.7	12.6	20.8	12.0	18.1	6.6	6.0	5.2
06.0	20,478	28.8	16.6	27.3	15.7	26.1	15.1	25.0	14.4	21.7	7.9	7.2	6.3
07.0	23,891	33.6	19.4	31.8	18.4	30.4	17.6	29.1	16.8	25.3	9.2	8.4	7.3
08.0	27,304	38.5	22.2	36.4	20.9	34.9	20.1	33.3	19.2	28.9	10.5	9.6	8.4
09.0	30,717	42.8	24.9	40.9	23.3	39.1	22.6	37.7	21.4	32.5	11.8	10.8	9.5
10.0	34,130	48.1	27.4	45.4	26.2	43.5	25.1	41.7	24.0	36.1	13.2	12.0	10.5
11.0	37,543	52.9	30.5	50.0	28.6	47.8	27.6	45.8	26.4	39.7	14.5	13.2	11.6
12.0	40,956	57.7	33.2	54.5	31.5	52.1	30.2	50.0	28.6	43.3	15.8	14.4	12.6
13.0	44,369	62.5	36.0	59.1	34.1	56.9	32.7	54.2	31.3	46.9	17.1	15.6	13.7
14.0	47,782	67.3	38.8	63.6	36.7	60.9	35.2	58.3	33.7	50.5	18.4	16.8	14.7
15.0	51,195	72.1	41.5	68.2	39.1	65.2	37.7	62.5	35.1	54.2	19.8	18.0	15.8
16.0	54,608	76.9	44.3	72.7	41.9	69.6	40.2	66.7	38.5	57.8	21.1	19.2	16.9
17.0	58,021	81.7	47.1	77.3	44.3	73.9	42.7	70.8	40.9	61.4	22.4	20.4	17.9
18.0	61,434	86.5	49.8	81.8	47.2	78.3	45.2	75.0	43.3	65.0	23.7	21.6	19.0
19.0	64,847	91.3	52.6	86.4	49.6	82.6	47.7	79.2	45.7	68.6	25.1	22.8	20.0
20.0	68,260	96.1	55.1	90.9	52.5	86.9	50.3	83.3	48.1	72.2	26.4	24.0	21.1
21.0	71,673	100.0	58.2	95.6	55.1	91.3	52.9	87.5	50.5	75.8	27.7	25.2	22.1
22.0	75,086	105.8	60.9	100.0	57.7	95.7	55.3	91.7	52.9	79.4	29.0	26.4	23.1
23.0	78,499	110.6	63.7	14.5	60.4	100.0	57.9	95.8	55.3	83.0	30.3	27.6	24.3
24.0	81,912	115.4	66.5	109.1	62.9	104.3	60.3	100.0	57.7	86.6	31.7	28.8	25.3
25.0	85,325	120.2	69.2	113.6	65.3	108.6	62.8	104.1	60.1	90.3	33.0	30.1	26.4
26.0	88,738	125.0	72.0	118.2	68.3	113.0	65.3	108.3	62.5	93.9	34.3	31.3	27.4
27.0	92,151	129.8	74.8	122.7	70.9	117.4	67.8	112.5	64.7	97.5	35.6	32.5	28.5
28.0	95,564	134.6	77.2	128.2	73.5	121.7	70.3	116.6	67.3	101.1	36.9	33.7	29.5
29.0	98,977	139.4	80.3	131.8	76.0	126.0	72.9	120.8	69.7	104.7	38.3	34.9	30.6
30.0	102,390	144.2	83.1	136.4	78.7	130.4	75.4	125.0	72.1	108.3	39.6	36.1	31.7
31.0	105,803	149.0	85.9	140.9	81.3	134.7	77.9	129.2	74.5	111.9	40.9	37.3	32.7
32.0	109,216	153.8	88.7	145.4	83.9	139.0	80.4	133.4	76.9	115.5	42.2	38.5	33.8
33.0	112,629	158.6	91.5	149.9	86.5	143.3	82.9	137.6	79.3	119.1	43.5	39.7	34.8
34.0	116,042	163.4	94.3	154.4	89.1	147.6	85.4	141.8	81.7	122.7	44.8	40.9	35.9
35.0	119,455	168.2	97.1	158.9	91.7	151.9	87.9	146.0	84.1	126.4	46.1	42.1	36.9
36.0	122,868	173.0	99.9	163.4	94.3	156.2	90.4	150.2	86.5	130.0	47.4	43.3	38.0
37.0	126,281	177.8	102.7	167.9	96.9	160.5	92.9	154.4	88.9	133.6	48.7	44.5	39.0
38.0	129,694	182.6	105.5	172.4	99.5	164.8	95.4	158.6	91.3	137.2	50.0	45.7	40.1
39.0	133,107	187.4	108.3	176.9	102.1	169.1	97.9	162.8	93.7	140.7	51.3	46.9	41.1
40.0	136,520	192.2	111.1	181.4	104.7	173.4	100.4	167.0	96.1	144.4	52.6	48.1	42.2
41.0	139,933	197.0	113.9	185.9	107.3	177.7	102.9	171.2	98.5	148.0	53.9	49.3	43.2
42.0	143,346	201.8	116.7	190.4	109.9	182.0	105.4	175.4	100.9	151.6	55.2	50.6	44.3
43.0	146,759	206.6	119.5	194.9	112.5	186.3	107.9	179.6	103.3	155.2	56.5	51.8	45.3
44.0	150,172	211.4	122.3	199.4	115.1	190.6	110.4	183.8	105.7	158.8	57.8	53.0	46.4
45.0	153,585	216.2	125.1	203.9	117.7	194.9	112.9	188.0	108.1	162.5	59.1	54.2	47.4
46.0	156,998	221.0	127.9	208.4	120.3	199.2	115.4	192.2	110.5	166.1	60.4	55.4	48.5
47.0	160,411	225.8	130.7	212.9	122.9	203.5	117.9	196.4	112.9	169.7	61.7	56.6	49.5
48.0	163,824	230.6	133.5	217.4	125.5	207.8	120.4	200.6	115.3	173.3	63.0	57.8	50.6
49.0	167,237	235.4	136.3	221.9	128.1	212.1	122.9	204.8	117.7	176.9	64.3	59.0	51.6
50.0	170,650	240.2	139.1	226.4	130.7	216.4	125.4	209.0	120.1	180.5	65.6	60.2	52.7
51.0	174,063	245.0	141.9	230.9	133.3	220.7	127.9	213.2	122.5	184.1	66.9	61.4	53.7
52.0	177,476	249.8	144.7	235.4	135.9	225.0	130.4	217.4	124.9	187.7	68.2	62.6	54.8
53.0	180,889	254.6	147.5	239.9	138.5	229.3	132.9	221.6	127.3	191.3	69.5	63.8	55.8
54.0	184,302	259.4	150.3	244.4	141.1	233.6	135.4	225.8	129.7	194.9	70.8	65.0	56.9
55.0	187,715	264.2	153.1	248.9	143.7	237.9	137.9	230.0	132.1	198.6	72.2	66.2	57.9
56.0	191,128	269.0	155.9	253.4	146.3	242.2	140.4	234.2	134.5	202.2	73.5	67.4	58.8
57.0	194,541	273.8	158.7	257.9	148.9	246.5	142.9	238.4	136.9	205.8	74.9	68.6	59.9
58.0	197,954	278.6	161.5	262.4	151.5	250.8	145.4	242.6	139.3	209.4	76.2	69.8	60.9
59.0	201,367	283.4	164.3	266.9	154.1	255.1	147.9	246.8	141.7	213.0	77.5	71.0	62.3
60.0	204,780	288.2	167.1	271.4	156.7	259.4	150.4	251.0	144.1	216.6	78.8	72.2	63.0

Note: All custom built products are subject to 100% cancellation/restock charges.

Heat Products	
198 Series Elements	1 Year
Elements in Baseboard	10 Years
All Other Heating Products	1 Year
Thermostats & Controls	2 Years

TPI UPC NUMBER IS REQUIRED
FOR ALL ORDERS PLACED
686334 X X X X X X

UPC #	MODEL	KW	BTU
686334			
739344	PHLA12-208160-3.0-24-TDP		
739337	PHLA12-208360-3.0-24-TDP		
739320	PHLA12-240160-3.0-24-TDP		
739313	PHLA12-240360-3.0-24-TDP	3	10,250
739306	PHLA12-480360-3.0-24-TDP		
739436	PHLA12-600360-3.0-24-TDP		
739399	PHLA12-208160-3.0-24-TDP		

IMPORTANT ORDERING POLICY
 When ordering any cataloged item the UPC number must be included with the order. This number must be the TPI Corporation UPC number and not the customer's item number. This policy applies to all orders including EDI orders.

Products manufactured by TPI Corporation are warranted to the original consumer to be free from defects in material and workmanship for twelve (12) months from the original date of purchase. The TPI warranty does not cover products modified outside our factory, damage or failure caused by acts of God, abuse, misuse, connected to or placed on other than rated voltage, abnormal usage, faulty installation, failure to follow suggested maintenance procedures enclosed with the product, improper maintenance or any repairs other than those provided by an authorized TPI Corporation service center.

There are no obligations or liabilities on the part of the corporation for consequential damages arising out of, or in connection with, the use or performance of the product, or other indirect damages with respect to loss of property, revenues, or profit, or costs of removal, installation or reinstallation.

All implied warranties with respect to TPI products, including implied warranties for merchantability and implied warranties for fitness, are limited in duration to twelve (12) months from original date of purchase, except those products or parts of products which are warranted for longer periods. On such products or parts of products all implied warranties for merchantability and fitness are limited to the duration of the extended warranty period thereon.

Some states do not allow the exclusion or limitation of incidental or consequential damages and some states do not allow limitations on how long an implied warranty lasts. The above exclusions or limitations may not apply to you.

During the warranty period, TPI Corporation will, at its sole option, repair or replace any defective parts or products returned, freight prepaid, to the TPI Corporation factory or such other location as TPI Corporation may designate. Returned products must be packaged carefully and TPI Corporation shall not be responsible for damage in transit. When returning parts, the owner must provide the model number of the product and nature of difficulty being experienced. This warranty does not obligate TPI Corporation to bear the cost of labor in replacing any assembly, unit or component part thereof, nor does the company assume any liability for secondary charges, expenses for installing or removal, freight or damages. There will be charges rendered for product repairs made after out warranty period has expired. Proof of purchase, including date, must accompany request for in-warranty service. In any event, TPI Corporation's maximum liability shall not in any case exceed the list price for the product claimed to be defective. This warranty gives to you specific legal rights and you may have other rights, which may vary, from state to state. For the name of you nearest authorized TPI Corporation service center, please write to TPI Corporation, P.O. Box 4973, Johnson City, Tennessee, 37602.

In addition to the Limited Warranty stated above covering general products, TPI Corporation extends this warranty on the following listed products, which are warranted to the original consumer from the original date of purchase for the total time periods indicated herein to the left:

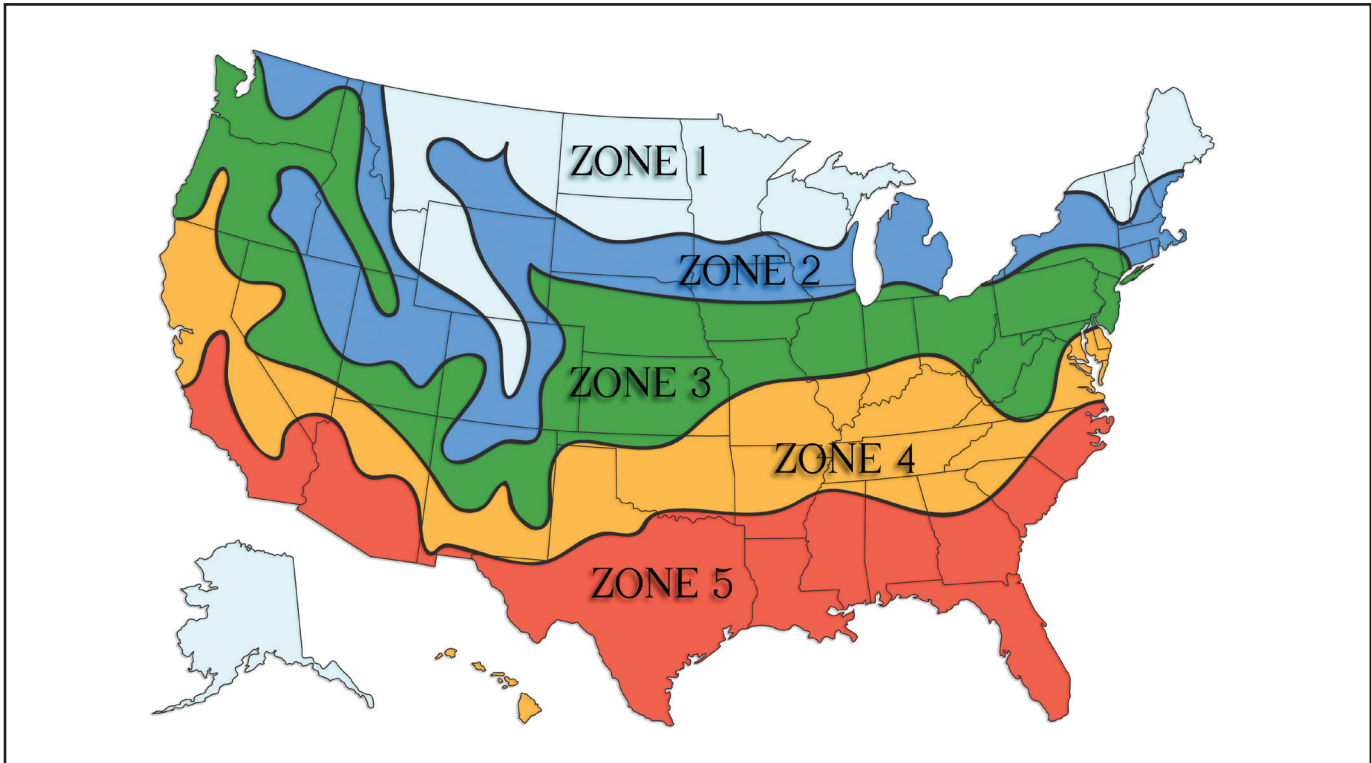

INSULATION			
R-VALUE	Recommended	FHA Standard	Minimum: Not Recommended
Ceiling	*R-24	*R-19	*R-11
Walls	R-13	11	R-7
Floor	R-24	11	----
ZONE	APPROXIMATE WATTAGE NEED PER SQUARE FOOT		
1	8.6	10.0	14.6
2	7.7	9.0	13.1
3	7.1	8.2	12.0
4	6.4	7.4	10.8
5	6.0	7.0	10.2

*R values are industry standards for insulation effectiveness. Ask company representative for assistance if you do not know "R" for your present structure insulation.

Baseboard or wall mount style? Recessed or surface type? It's easy to select the heater that's right for you.

1. Measure the size of the room(s) or area you intend to heat for square footage. You will need the length times the width to get this calculation.
2. Find your location on the map above. This determines your basic heating zone.
3. The chart shown below the map lists insulation values based on the effectiveness of the insulation presently in your home. Find your heating zone on the chart and the approximate wattage per square foot you will need.
4. Multiply the total number of square feet you intend to heat by the approximate wattage per square foot you just obtained. This will determine your total heating requirement in watts for the room.

How Much Heat is Right For You?

Figures are based on 15% total window and door openings in outside walls, and 3/4 total home air changes per hour. Typical frame-type construction with unheated basement or unventilated crawl space. If you do not have storm doors and windows, add 30% to the watts per square foot (multiply by 1.3).

That's all there is to it! Now choose the heater with a wattage equal to what you need. Your final selection will, of course, depend on available wall space, window placement, ect.

Sample Calculation:

- Example = 10' x 12' room in Zone 3 with FHA standard insulation
1. Determine room square footage: 10' x 12' = 120 sq. ft.
 2. Zone 3 with FHA standard insulation requires 8.2 watts per sq. ft.
 3. Multiply square footage of room to be heated by the approximate wattage per square foot required.

120 sq. ft x 8.2 watts = 984 watts required.
 From this calculation it can be reasoned that a 1000 watt heater would be required.

HLA Series Hazardous Location Fan Forced Unit Heater

FAN-FORCED SUSPENDED UNIT HEATERS 3-25 KW FOR T-3B CLASS I, GROUP C & D, DIVISION 1 & 2 AND CLASS II, GROUPS E, F & G, DIVISIONS 1 & 2.

4



Shown with optional pilot light and disconnect switch



Manufactured in U.S.A.

- Designed for rugged industrial applications in hazardous locations where the possibility of explosion or fire exists due to the presence of certain flammable gases, vapors, powdered metals or dust.
- Permanently sealed, liquid to air, finned tube heat exchanger core.
- Ethylene Glycol to water mixture used as a heat transfer fluid in the heater core, providing -45° C. (-49° F) freeze damage protection.
- High-performance electric motor driven fan blows air across finned tubes to effect uniform heat transfer and area heat distribution.
- Manual Reset capillary type limit provides high temperature regulation and is rated for 6,000 cycles of service.
- Stainless steel and aluminum pressure relief valve for overpressure.
- A back-up contactor is included for additional protection.
- 14 gauge steel cabinet powder coated epoxy paint finish contains heater core, motor, and fan assembly.
- Narrow gap safety fan guard shields all moving parts.
- Adjustable louvers allow directional control of air.
- Copper conductor wires enclosed in rigid metal conduits carry all electrical power.
- Box lugs furnished for field connections within approved enclosure.

Product Specifications

Heat Exchanger and Elements:

Heavy walled, painted carbon steel with aluminum fins liquid heat exchanger, liquid filled with three-immersion type copper sheathed elements. The elements shall have the highest quality nickel-chromium resistance wire encased in a magnesium oxide dielectric and be hermetically sealed into the heat exchanger core. The heat transfer fluid is Ethylene-glycol solution for operation to -49 degrees F (-45 degrees C). Stainless steel and aluminum pressure relief valve for overpressure.

Thermal Cutout High Limit Protection and Optional Pilot Light:

The capillary type manual reset thermal cutout shall be rated for 6000 cycles of service and mounted in the liquid filled heat exchanger. An optional pilot light to indicate manual reset tripped, if safe operating temperatures are exceeded, is located on control enclosure.

Motor:

The motor shall be a permanent split capacitor type, permanently lubricated, ball bearing type. The motor shall be rated for hazardous location and operate at rated voltage of heater, 60 Hz, 1725 RPM.

Control Enclosure:

All controls shall be factory installed and wired in a hazardous location enclosure. Contactors and back-up contactors are heavy duty type and break all ungrounded conductors and be rated for 100,000 cycles at full load. Standard 24-Volt control circuit shall be supplied by internal class II transformer. An optional factory wired integral thermostat or standard terminal block for field wiring to optional remote wall thermostat are wired in control panel. No fan delay relay.

Disconnect Switch:

Factory mounted and wired hazardous location disconnect switch is available as optional accessory.

Cabinet With Adjustable Louvers:

The Cabinet shall be 14 gauge, cold rolled steel with powder coated epoxy finish. Plated fan guards with less than 1/4 inch spacing to cover motor and fan shall conform to OSHA Requirements.

Note:

Before selecting a hazardous location electric heater refer to Article 500 or other applicable standard referenced in the National Electric Code.

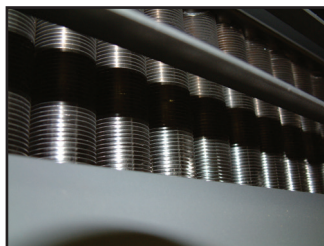

Liquid-to-air heat exchanger



Optional built-in thermostat



Hazardous Location Rated Motor

HLA Series Hazardous Location Fan Forced Unit Heater

Rating Definitions

CLASS I: Equipment does not have surface operating temperature in excess of the ignition temperature of the specific gas or vapor.

Application Examples:

- Offshore and land based drilling rigs, petroleum exploration and testing facilities.
- Petroleum refineries, gasoline storage and dispensing areas.
- Industrial firms that use flammable liquids in dip tanks for parts cleaning or other operations.
- Petrochemical companies that manufacture chemicals from gas or oil.
- Dry cleaning facilities where vapors from cleaning fluids may be present.
- Aircraft hangers and fuel servicing areas.
- Utility gas plants and operations involving storage and handling of liquefied petroleum or natural gas.

GROUP C: Atmospheres such as but not limited to acetaldehyde, allyl alcohol, hydrogen sulfide, ethylene, carbon monoxide, or other gases or vapors of equivalent hazard.

GROUP D: Atmospheres such as but not limited to acetone, alcohol, gasoline, lacquer solvent vapors, natural gas, propane or other gases or vapors of equivalent hazard.

CLASS II: Equipment does not have surface temperature greater than the ignition temperature of the specified dust.

Application Examples:

- Coal preparation plants and other carbon handling or processing areas.
- Grain elevators, flour and feed mills.
- Plants which manufacture, use or store Magnesium or Aluminum powders.
- Plants that have chemical or metallurgical processes.
- Producers of starch products or candy.
- Spice grinding plants, sugar plants and cocoa plants.

GROUP E: Atmosphere containing combustible metal dust regardless of resistivity, or other combustible dust of similar hazard characteristics having resistivity of less than 10^5 OHM - Centimeter.

GROUP F: Atmosphere containing carbon black, charcoal, coal or coke dust.

GROUP G: Atmospheres containing combustible dust having resistivity of 10^5 OHM-Centimeter or greater.

DIVISION I: A location in which ignitable concentrations of flammable material exist under normal operating conditions.

DIVISION II: Locations in which flammable materials will normally be confined within closed containers and escape only in the case of accidental rupture, breakdown or during maintenance operations. Any equipment approved for Division I is automatically also approved for Division II.

Standard Hazardous Location Models

UPC# 686334	MODEL	KW	BTU's	VOLTS	PH	AMPS	Control Voltage	Temp Rise °F	Air Throw	CFM	Recom'd Mounting Ht.	WT.	LIST
734356	HLA 12-208160-3.0-24	3	10250	208	1	16.3	24	16.5			8'	167 lb.	8999
734004	HLA 12-208360-3.0-24			208	3	9.8							
734011	HLA 12-240160-3.0-24			240	1	14.8							
734028	HLA 12-240360-3.0-24			240	3	8.6							
734035	HLA 12-480360-3.0-24			480	3	4.3							
734363	HLA 12-208160-5.0-24	5	17100	208	1	26		27.6	24'	580	8'	167 lb.	9378
734059	HLA 12-208360-5.0-24			208	3	15.4							
734066	HLA 12-240160-5.0-24			240	1	23.1							
734073	HLA 12-240360-5.0-24			240	3	13.4							
734080	HLA 12-480360-5.0-24			480	3	6.7							
734370	HLA 12-208160-7.5-24	7.5	25600	208	1	38		41.4			8'	167 lb.	9749
734103	HLA 12-208360-7.5-24			208	3	22.3							
734110	HLA 12-240160-7.5-24			240	1	33.6							
734127	HLA 12-240360-7.5-24			240	3	19.4							
734134	HLA 12-480360-7.5-24			480	3	9.7							
734158	HLA 16-208360-10.0-24	10	34150	208	3	29.3	21.7	40'	1500	10'	193 lb.	10313	
734165	HLA 16-240160-10.0-24			240	1	44							
734172	HLA 16-240360-10.0-24			240	3	25.5							
734189	HLA 16-480360-10.0-24			480	3	12.7							
734202	HLA 20-208360-15.0-24	15	51200	208	3	43.5	19.2	43'	2450	13'	193 lb.	10760	
734219	HLA 20-240360-15.0-24			240	3	38.1							
734226	HLA 20-480360-15.0-24			480	3	19							
734233	HLA 20-600360-15.0-24			600	3	15.2							
734240	HLA 20-480360-20.0-24			480	3	25.1							
734257	HLA 20-600360-20.0-24	20	68300	600	3	20	26.2	225 lb.		11176			
734264	HLA 20-480360-25.0-24	25	85400	480	3	31.1	32.8						12168
734271	HLA 20-600360-25.0-24			600	3	24.9							

Note: Products listed in this section are custom built and subject to 100% cancellation/restock charges.

HLA Series Hazardous Location Fan Forced Unit Heater

Mounting Bracket Kits

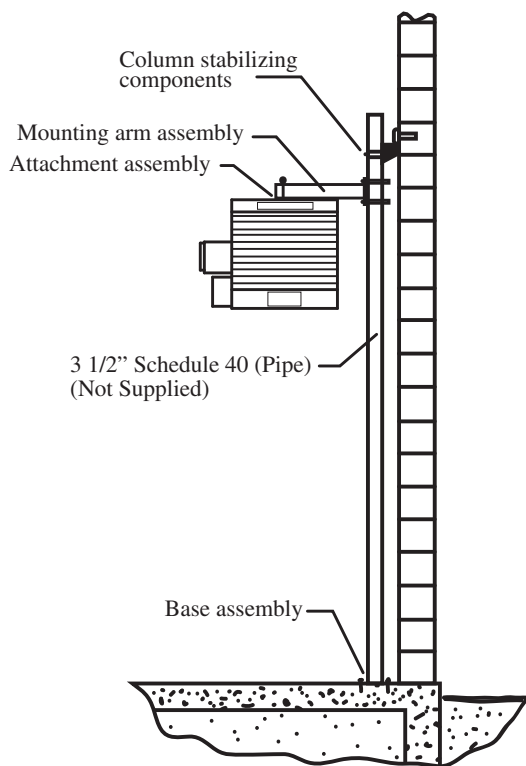

HLPM Pipe Mounting Kit

Particularly useful in buildings with insufficient strength to use other types of mounts. Requires 3 1/2" pipe (4" O.D. - not supplied).

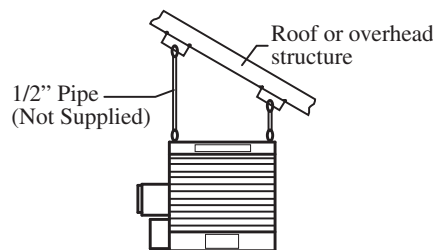

HLHM Hanging Mounting Kit

Simple and economical if adequate overhead structure exists. Requires 1/2" pipe, cut and threaded (not supplied).

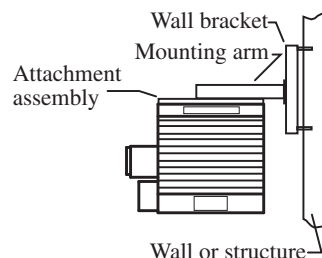

HLWM Wall Mounting Kit

Ideal for use in buildings that have substantial walls. Arm only can also be bolted directly to structural steel.

UPC#	MODEL	USE WITH HEATERS	WT. (LBS.)	LIST
686334				
734288	HLPM37	3.0 kW - 7.5 kW	37	479
734295	HLPM10	10.0 kW	38	
734301	HLPM1525	15.0 kW - 25.0 kW	40	
734318	HLHM	ALL	5	191
734325	HLWM37	3.0 kW - 7.5 kW	27	399
734332	HLWM10	10.0 kW	28	
734349	HLWM1525	15.0 kW - 25.0 kW	29	

EPET Series and HLT Series Hazardous Location Thermostats For Single Phase



HLT Series



Motor Rating (full load): 3/4 HP @ 125V, 1 1/2 HP @ 250V
 Pilot Duty Rating 125VA @ 24VAC
 NEMA Class Seven Div. 1 Approved
 Class I Group C & D, Class II Group E, F, & G
 Not rated for Group B



Features

- SPDT & DPDT Models
- Heat or cool compatible
- Celsius and Fahrenheit temperature scale
- Bi-Metal or capillary sensor
- Snap action switch
- Casting tapped top and bottom for 3/4" conduit
- 1/2" thick cast aluminum housing
- Dimension 5.75" x 6.375" x 5.57"

UPC#	MODEL	DESCRIPTION	LOAD RATINGS	RANGE	LIST
686334					
538077	EPETD8D	DPDT - Bi-Metal	22A @120-277VAC	50-90°F	337
538107	EPETD8S	SPDT - Bi-Metal	22A @120-277VAC	50-90°F	
528078	EPETP8D	DPDT - Bi-Metal	22A @120-480VAC	50-90°F	
528061	EPETP8S	SPDT - Bi-Metal	22A @120-480VAC	50-90°F	
523158	HLT-1	SPDT - Capillary	22A @120-277VAC	40-110°F	476
523165	HLT-2	DPDT - Capillary	22A @120-277VAC	40-110°F	502
Master ctn: 4 pcs, 24 lbs (varies slightly by model), 16" x 14.5" x 6"					
EPET Series incorporate plastic knob & Bi-Metal Sensor housing.					
HLT Series incorporates screwdriver temperature adjustment slot and all metal housing. External bulb and capillary sensor.					

HLA Series Hazardous Location Fan Forced Unit Heater

Factory Installed Accessories & Physical Dimensions

SUFFIX	DESCRIPTION	LIST ADDER
T	In-Built single pole thermostat 50° - 90° F	318
120	Control transformer w/ primary fusing (Delete 24 suffix - add 120)	228
208	208/240V Control available on 208/240V units (Delete 24 suffix and add 208 OR 240)	Subtract 63
240		
D	Disconnect Switch	1574
P	Pilot Light	882

MODEL	A	B	C		D	E	F	G
			3 ph.	1 ph.				
HLA 12	17 3/4	22 3/8	19 3/4	20 5/8	16 1/4	10 1/2	14	3
HLA 16	20 3/4	26 3/8	20 3/4	21 5/8	20 1/4	11 1/2	18	4
HLA 20	24 3/4	30 3/8	22 1/2	N/A	24 1/4	12 1/2	22	4 1/2

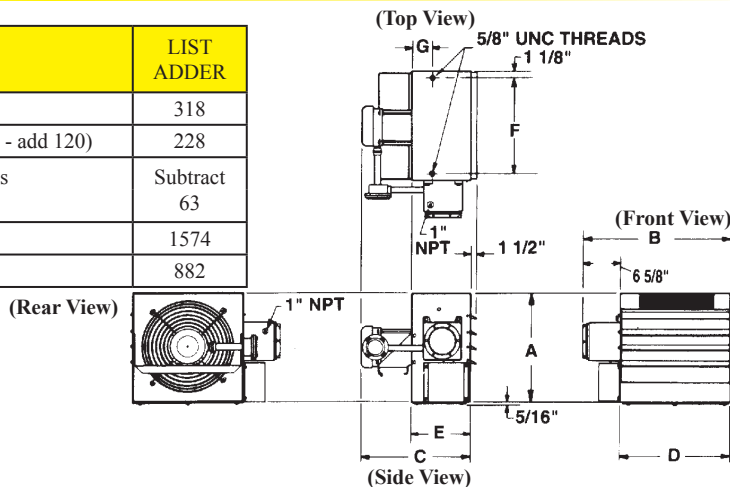

PHLA Series Portable Hazardous Location Fan Forced Unit Heater



- 3.0 through 25 KW rating
- 208, 240, 480, 600 Volt available in selected capacities
- Cart has anti-static wheels to reduce the risk of static discharge
- Wheeled cart allows for easy maneuverability
- Cart has integrated fork-lift channels to provide ease of lifting on to ramps or trucks
- Excellent for providing seasonal heating in hazardous environments
- All units have disconnect switch, pilot light, and thermostat - standard
- 24 Volt control, transformer, and contactor in NEMA 7 enclosure
- Durable epoxy coating on heater housing
- Hazardous location unit mounted male / female plug
- Adjustable louvers; manual reset

Standard Portable Hazardous Location Models

UPC #	MODEL	KW	BTU	VOLTS	PH	AMPS	TEMP RISE F	AIR THROW	CFM	WT	LIST
686334											
739344	PHLA12-208160-3.0-24-TDP	3	10,250	208	1	16.3	16.5	24'	580	260	19,950
739337	PHLA12-208360-3.0-24-TDP			208	3	9.8					
739320	PHLA12-240160-3.0-24-TDP			240	1	14.8					
739313	PHLA12-240360-3.0-24-TDP			240	3	8.6					
739306	PHLA12-480360-3.0-24-TDP			480	3	4.3					
739436	PHLA12-600360-3.0-24-TDP			600	3	3.5					
739290	PHLA12-208160-5.0-24-TDP	5	17,100	208	1	26	27.6	24'	580	260	20,300
739283	PHLA12-208360-5.0-24-TDP			208	3	15.4					
739276	PHLA12-240160-5.0-24-TDP			240	1	23.1					
739269	PHLA12-240360-5.0-24-TDP			240	3	13.4					
739252	PHLA12-480360-5.0-24-TDP			480	3	6.7					
739429	PHLA12-600360-5.0-24-TDP			600	3	5.4					
739245	PHLA12-208160-7.5-24-TDP	7.5	25,600	208	1	38	41.4	24'	580	260	20,700
739238	PHLA12-208360-7.5-24-TDP			208	3	22.3					
739221	PHLA12-240160-7.5-24-TDP			240	1	33.6					
739214	PHLA12-240360-7.5-24-TDP			240	3	19.4					
739207	PHLA12-480360-7.5-24-TDP			480	3	9.7					
739412	PHLA12-600360-7.5-24-TDP			600	3	7.8					
739191	PHLA16-208360-10.0-24-TDP	10	34,150	208	3	29.3	21.7	40'	1500	305	22,400
739184	PHLA16-240160-10.0-24-TDP			240	1	44					
739177	PHLA16-240360-10.0-24-TDP			240	3	25.5					
739160	PHLA16-480360-10.0-24-TDP			480	3	12.7					
739405	PHLA16-600360-10.0-24-TDP			600	3	10.2					
739153	PHLA20-208360-15.0-24-TDP			208	3	43.5					
739146	PHLA20-240360-15.0-24-TDP	15	51,200	240	3	38.1	19.2	43'	2450	350	24,140
739139	PHLA20-480360-15.0-24-TDP			480	3	19					
739399	PHLA20-600360-15.0-24-TDP			600	3	15.2					
739122	PHLA20-480360-20.0-24-TDP	20	68,300	480	3	25.1	26.2	43'	2450	350	24,600
739382	PHLA20-600360-20.0-24-TDP			600	3	20					
739115	PHLA20-480360-25.0-24-TDP	25	85,400	480	3	31.1	32.8	43'	2450	350	25,400
739375	PHLA20-600360-25.0-24-TDP			600	3	24.9					

Note: Products listed in this section are custom built and subject to 100% cancellation/restock charges.

FEP Series Single Phase Hazardous Location Wall Convectors

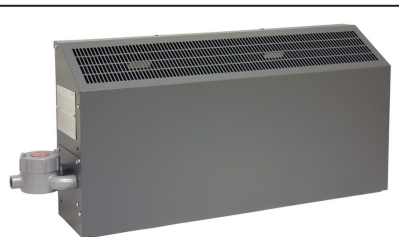

Standard Unit



Unit with optional control section containing disconnect, pilot light, and thermostat (Suffix C1-TDP)



Unit with in-built EPET line voltage thermostat (Suffix T1 or T2)

Manufactured in U.S.A.

- Cabinet size 18" high, 9" wide.
- Bottom In - Front Out air flow.
- Wall mounting bracket supplied.
- Units cannot be operated in room ambients exceeding 104°F (40°C).
- Heavy duty 16 gauge steel with gray epoxy textured powder coated finish.
- 9" minimum clearance from bottom of heater to floor required.
- Stainless steel cartridge element inserted into Aluminum finned Copper sheath.
- Standard unit (without EPET thermostat or control section) is NEMA 4 rated.



T-2A SERIES SINGLE PHASE Class 1, Group B, C & D Division 1 & 2 280° C / 536° F								
UPC 686334	MODEL	WATTS	BTU's	VOLTS	AMPS	CABINET LENGTH	WT. (LBS.)	LIST
445146	FEP-1812-1RA	1800	6143	120	15.0	34"	50	1493
445153	FEP-1820-1RA			208	8.7			
445160	FEP-1824-1RA			240	7.5			
445177	FEP-1827-1RA			277	6.5			
445184	FEP-1848-1RA			480	3.8			
445191	FEP-3620-1RA	3600	12286	208	17.3	34"	54	2278
445207	FEP-3624-1RA			240	15.0			
445214	FEP-3627-1RA			277	13.0			
445221	FEP-3648-1RA			480	7.5			
445238	FEP-3657-1RA			600	6.0			
445245	FEP-3820-1RA	3800	12969	208	18.3	58"	80	2416
445252	FEP-3824-1RA			240	15.8			
445269	FEP-38271-RA			277	13.7			
445276	FEP-3848-1RA			480	7.9			
445283*	FEP-7620-1RA			7600	25938			
445290*	FEP-7624-1RA	240	31.7					
445306*	FEP-7627-1RA	277	27.4					
445313	FEP-7648-1RA	480	15.8					
445320	FEP-7657-1RA	600	12.7					

*Items may not be used with 22 Amp line voltage thermostat



T-3A SERIES SINGLE PHASE Class 1, Group B, C & D Division 1 & 2 180° C / 356° F								
445337	FEP-0812-1RA	800	2730	120	6.7	34"	50	1493
445344	FEP-0820-1RA			208	3.8			
445351	FEP-0824-1RA			240	3.3			
445368	FEP-0827-1RA			277	2.9			
445375	FEP-0848-1RA			480	1.7			
445382	FEP-1612-1RA	1600	5460	120	13.3	34"	54	2278
445399	FEP-1620-1RA			208	7.7			
445405	FEP-1624-1RA			240	6.7			
445412	FEP-1627-1RA			277	5.8			
445429	FEP-1648-1RA			480	3.3			
445436	FEP-1657-1RA	1700	5802	600	2.7	58"	80	2416
445443	FEP-1712-1RA			120	14.2			
445450	FEP-1720-1RA			208	8.2			
445467	FEP-1724-1RA			240	7.1			
445474	FEP-1727-1RA			277	6.1			
445481	FEP-1748-1RA	3400	11604	480	3.5	58"	85	2811
445498	FEP-3420-1RA			208	16.3			
445504	FEP-3424-1RA			240	14.2			
445511	FEP-3427-1RA			277	12.3			
445528	FEP-3448-1RA			480	7.1			
445535	FEP-3457-1RA		600	5.7				

Factory Installed Control Options

SUFFIX*	DESCRIPTION	LIST	SUFFIX**	DESCRIPTION	LIST
T1	EPETD8S single pole thermostat factory mounted to 120V - 480V units	578	C1-TD	Control section with transformer, 24V contactor, SP thermostat (40°F - 90°F) and disconnect switch (all units)	1986
T2	EPETD8D double pole thermostat factory mounted to 120V - 480V units	599	C1-TDP	Control section with transformer, 24V contactor, SP thermostat (40°F - 90°F), disconnect switch & pilot light (all units)	2063

*Remove - RA suffix and add new suffix. **Remove - RA suffix and add new suffix (Not NEMA washdown rated or rated for Group B atmospheres) Suffix "T" is 22 Amps maximum.

Note: Products listed in this section are custom built and subject to 100% cancellation/restock charges.

FEP Series Three Phase Hazardous Location Wall Convectors

- Cabinet size 18" high, 9" wide.
- Bottom In - Top Out air flow.
- Wall mounting bracket supplied.
- Units can not be operated in room ambients exceeding 104°F (40°C).
- Heavy duty 16 gauge steel with gray epoxy textured powder coated finish.
- 9" minimum clearance from bottom of heater to floor required.
- Stainless steel cartridge element inserted into Aluminum finned Copper sheath.
- Standard unit (without EPET thermostat or control section) is NEMA 4 rated.

T-2A SERIES THREE PHASE Class 1, Group B, C, & D Divisions 1 & 2 280° C / 536° F								
UPC 686334	MODEL	WATTS	BTU's	VOLTS	AMPS	CABINET LENGTH	WT. (LBS.)	LIST
483056	FEP-1820-3RA	1800	6143	208	5.0	34"	50	1719
483063	FEP-1824-3RA			240	4.3			1869
486224	FEP-1848-3RA	3600	12286	480	2.2	34"	54	2622
483070	FEP-3620-3RA			208	10.0			2726
483087	FEP-3624-3RA	3800	12969	240	8.7	58"	80	2784
486231	FEP-3648-3RA			480	4.3			2999
483094	FEP-3820-3RA	7600	25938	208	10.5	58"	85	3223
483100	FEP-3824-3RA			240	9.1			
486248	FEP3848-3RA			480	4.6			
483117	FEP-7620-3RA			208	21.1			
483124	FEP-7624-3RA			240	18.3			
486255	FEP-7648-3RA			480	9.2			

T-3A SERIES THREE PHASE Class 1, Group B, C & D Division 1 & 2 180° C / 356° F								
UPC 686334	MODEL	WATTS	BTU's	VOLTS	AMPS	CABINET LENGTH	WT. (LBS.)	LIST
483131	FEP-0820-3RA	800	2730	208	2.2	34"	50	1719
483148	FEP-0824-3RA			240	1.9			1869
486262	FEP-0848-3RA	1600	5460	480	0.9	34"	54	2622
483155	FEP-1620-3RA			208	4.4			2726
483162	FEP-1624-3RA	1700	5802	240	3.8	58"	80	2784
486279	FEP-1648-3RA			480	1.9			2999
483179	FEP-1720-3RA	3400	11604	208	4.7	58"	85	3192
483186	FEP-1724-3RA			240	4.1			
486286	FEP-1748-3RA			480	2.0			
483193	FEP-3420-3RA			208	9.4			
483209	FEP-3424-3RA			240	8.2			
486293	FEP-3448-3RA			480	4.1			

*T1 and T2 option not available on 3 phase models

Factory Installed Control Options

SUFFIX**	DESCRIPTION	LIST
C1-TD	Control section with transformer, 24V contactor, SP thermostat (40°F - 90°F) and disconnect switch (all units)	1971
C1-TDP	Control section with transformer, 24V contactor, SP thermostat (40°F - 90°F), disconnect switch & pilot light (all units)	2047

Note: C1-TD and C1-TDP are only options available for 3 phase units.

**Remove - RA suffix and add new suffix (Not NEMA washdown rated or rated for Group B atmospheres)

Remote Mounted Hazardous Location Thermostats For Single Phase Models Only



UPC# 686334	MODEL	DESCRIPTION	LOAD RATINGS	RANGE	LIST
538077	EPETD8D	DPDT - Bi-Metal	22A @120-277VAC	50-90°F	337
538107	EPETD8S	SPDT - Bi-Metal	22A @120-277VAC	50-90°F	
528078	EPETP8D	DPDT - Bi-Metal	22A @120-480VAC	50-90°F	
528061	EPETP8S	SPDT - Bi-Metal	22A @120-480VAC	50-90°F	
523158	HLT-1	SPDT - Capillary	22A @120-277VAC	40-110°F	476
523165	HLT-2	DPDT - Capillary	22A @120-277VAC	40-110°F	502
Master ctn: 4 pcs, 24 lbs (varies slightly by model), 16" x 14.5" x 6"					
EPET Series incorporates plastic knob & Bi-Metal Sensor housing.					
HLT Series incorporates screwdriver temperature adjustment slot and all metal housing. External bulb and capillary sensor.					

EPET Series Parameters

Dimensions: Height 5 5/8", Width 6 3/8", Depth 4 1/2"
 Finish: Silver-Gray
 Type: Single or Double Pole

Note: Products listed in this section are custom built and subject to 100% cancellation/restock charges.

Motor Rating: (full load) 1 1/2 HP @ 250V
 Rating: 22A @ 125-277VAC; 125VA @ 24VAC
 Rated: Class I Group C & D, Class II Group E, F, G
 Thermostat is not rated for use in Group B environments.

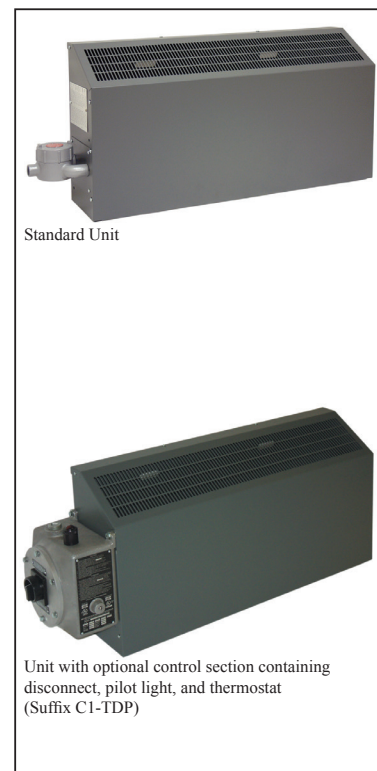

Standard Unit

Unit with optional control section containing disconnect, pilot light, and thermostat (Suffix C1-TDP)

Note: Controls mounted on the left side only.

5500 Series Washdown Fan Forced Unit Heater

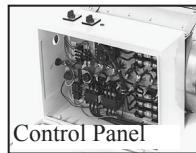
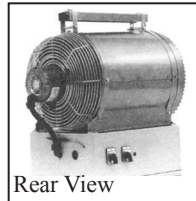

Manufactured in U.S.A.

- Heavy-duty 304 16 gauge stainless steel shroud.
- 316 stainless construction available.
- Nema 4x non-metallic control panel.
- 24-Volt transformer and control panel.
- 3-position switch (off-heat-fan).
- Capillary thermostat with stainless steel sensor.
- Automatic reset thermal cutout.
- Totally enclosed U.L. listed motor.
- Pilot light (power on indicator).



The Washdown Series unit heaters are electric unit heaters constructed for use in areas that require washing or hosing of equipment due to dirty or dusty industrial environments in non-hazardous locations. The totally enclosed water-tight construction made with corrosion-resistant material make this series ideal for industrial heating applications. The Washdown Series is constructed with all built-in controls and safety temperature controls wired in a non-metallic Nema 4x control panel with single-point power connections.

- Stainless steel finned tubular element. Constructed of 304 or 316 stainless rod and fins.
- Control panel on bottom of unit for ease of installation and service.
- Disconnect switch with enclosure door interlock.
- Front grill rotates to direct airflow.
- Single-point power connection.
- Fan Blade Epoxy coated Aluminum.
- Epoxy painted cold roll steel model available, consult factory
- Meets all U.L., NEC, and OSHA requirements (when installed as directed).
- Corrosion-resistant in high humidity and water-saturated areas (for areas where corrosion resistance is needed in non-explosive areas, contact factory for heater applications and optional materials).
- ABS (American Bureau of Shipping) type approved.
- Thermostat temp range: 40°-100°F



Mounting Bracket Kits & Product Dimensions

SIZE KW	UPC# 686334	STAINLESS STEEL COMBINATION BRACKET	LIST	UPC# 686334	WALL MTG. BRACKET *	LIST	UPC# 686334	HANGING BRACKET *	LIST	UPC# 686334	PIPE MTG. BRACKET *	LIST
3.3-15	713672	A5520/UHB	293	713726	W5520/WMK	417	713702	H5520/HMK	293	713689	P5520/PMK	417
20-48		----	-	713733	W5550/WMK		713719	H5550/HMK		713696	P5550/PMK	

* Material: Heavy Duty Epoxy Powder Coat Finish.

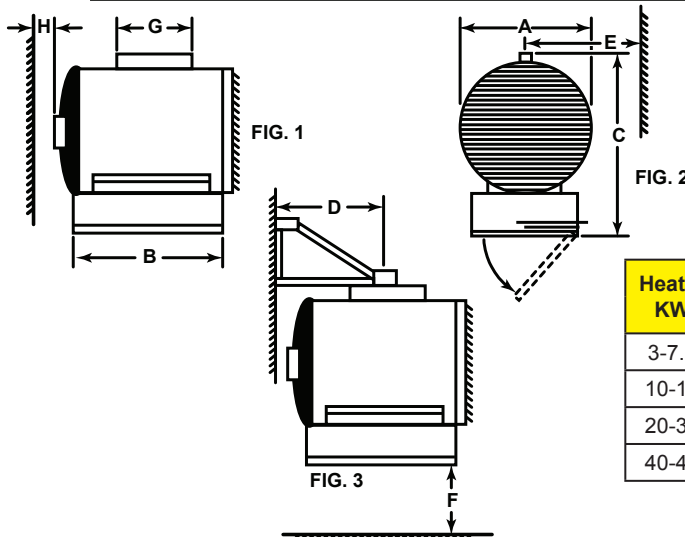
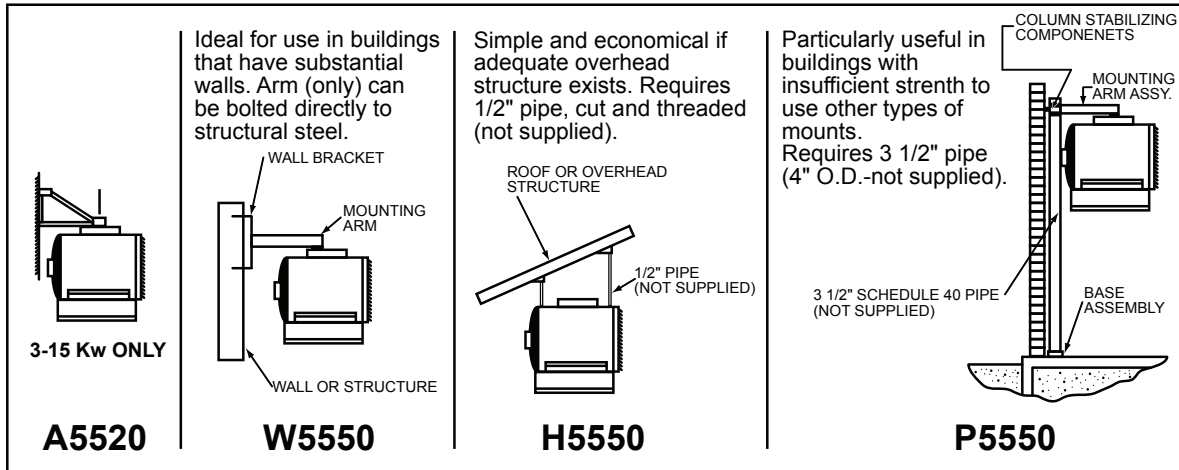

Heater KW	Heater Dimension in Inches unless otherwise stated.							
	A	B	C	D	E	F	G	H
3-7.5	12.00	18.00	19.75	15.25	16.25	6 ft.	8.00	6.00
10-15	14.00	19.00	21.75	15.25	18.00		8.00	6.00
20-30	16.00	27.00	28.75	19.50	17.50		15.50	4.50
40-48	18.00	31.00	30.75	19.50	19.50		21.75	2.75

5500 Series Washdown Fan Forced Unit Heater

Product Specifications & Standard Washdown Models

Enclosure and Motor: Element housing shall be 16 gauge 304 or 316 stainless steel shroud. The outlet grill and louver assembly shall be 304/316 stainless steel and rotate for direction of discharge air. The heater shall have a 304/316 stainless steel inlet grill and fan guard. The motor shall be totally enclosed, permanently lubricated and designed to resist moisture and corrosion. The fan blade shall be aluminum with a powder coated epoxy finish.

Element: The heating element shall be 304 or 316 stainless steel tube with 304/316 stainless steel fin material helically attached to the tube for even heat transfer. The element designed with the highest quality nickel-chromium resistance wire embedded in compacted efficient dielectric to ensure proper heat transfer.

Control Panel: The control enclosure shall be non-metallic Nema 4X control panel water-tight and dust-tight. The enclosure and elements are attached to the control panel with stainless steel fasteners. Standard control components are factory mounted and wired with access through control panel door on bottom of heater assembly. A standard door interlock disconnect switch shall be factory mounted and wired for safety.

Controls: All controls shall be factory mounted and wired in Nema 4X panel. Terminal block, 24 Volt transformer, high temperature limits, contactor and fusing if required by NEC are mounted and wired in control panel. A three-position switch (Off-Heat-Fan) shall be mounted on side of control panel for access from outside of panel. A pilot light to indicate power is on for safety shall be located on side of control panel. A wall mounted Nema 4X thermostat is an optional accessory.

Mounting Bracket: A formed 304/316 stainless steel bracket shall be used on 3.3 thru 15 KW units. A cast iron epoxy painted bracket shall be used on 20 thru 48 KW units. Above brackets shall be combination wall/ceiling type. Optional mounting brackets are available.

UPC# 686334	MODEL	KW	BTU's	VOLTS	PH	AMPS	CONTROL VOLTAGE	TEMP RISE °F	AIR THROW	CFM	WT. (lbs.)	LIST
713047	F1F5503T	3.3	11200	208	1	15.9	24	26				3953
713054	F3F5503T			208	3	9.2						
713061	H1H5503T			240	1	13.7						
713078	H3H5503T			240	3	7.9						
713085	G1G5503T			277	1	11.9						
713092	P3P5503T			480	3	4						
713115	F1F5505T	5	17100	208	1	24.1		40	20'	400	58	4103
713122	F3F5505T			208	3	13.9						
713139	H1H5505T			240	1	20.8						
713146	H3H5505T			240	3	12.1						
713153	G1G5505T			277	1	18.1						
713160	P3P5505T			480	3	6.1						
713184	F1F5507T	7.5	25600	208	1	36.1		60				4673
713191	F3F5507T			208	3	20.8						
713207	H1H5507T			240	1	31.3						
713214	H3H5507T			240	3	13.1						
713221	G1G5507T			277	1	27.1						
713238	P3P5507T			480	3	9.1						
713252	F1F5510T	10	34130	208	1	47.8		45				5623
713269	F3F5510T			208	3	27.7						
713276	H1H5510T			240	1	41.2						
713283	H3H5510T			240	3	24.1						
713290	G1G5510T			277	1	36.1						
713306	P3P5510T			480	3	12.1						
713399	F1F5515T	15	51200	208	1	72.1	68				6448	
713405	F3F5515T			208	3	41.7						
713412	H1H5515T			240	1	62.5						
713429	H3H5515T			240	3	36.1						
713443	P3P5515T			480	3	18.1						
713467	F3F5520T			20	68260	208						3
713474	H3H5520T	240	3			48.2						
713481	P3P5520T	480	3			24.1						
713504	F3F5525T	25	85325	208	3	69.5	56	35'	1400	92	7407	
713511	H3H5525T			240	3	60.2						
713528	P3P5525T			480	3	30.1						
713542	F3F5530T	30	102390	208	3	83.4	68				8087	
713559	H3H5530T			240	3	72.3						
713566	P3P5530T			480	3	36.1						
713603	P3P5540T	40	136520	480	3	48.2	70	42'	1800	126	8431	
713641	P3P5548T	48	163824	480	3	57.8	84				10484	

Note: For 60Amp disconnect add \$50.00 Net. Add 'D' as the suffix; For optional monel elements, add 40% to the net of the heater. For powder coat epoxy painting of shroud, add \$210 list to heater pricing. For 316 stainless add 20% to net price of the heater.

Remote Rain-Tight Thermostat



UPC# 686334	MODEL	DESCRIPTION	LIST
523424	TW155A	1 POLE, 40-110 deg F, 22Amp	179
523431	TW255A	2 POLE, 40-110 deg F, 22Amp	209

Note: NEMA 4X Construction Stainless Steel Hardware
 Note: Products listed in this section are custom built and subject to 100% cancellation/restock charges.

UH Series Horizontal Fan Forced Unit Heater

3.3 KW THROUGH 48 KW HORIZONTAL DISCHARGE SUSPENDED FAN FORCED UNIT HEATERS
AVAILABLE IN 1 OR 3 PHASE FOR ALL STANDARD VOLTAGES FROM 208V TO 480V.



Manufactured in U.S.A.

NOTE: Louver assembly is square and mounted with screws. Louver can be removed and repositioned for four (4) directional air flow - left - right - up - down with the heater in the horizontal position.

FACTORY INSTALLED OPTIONS:

- 24 Volt transformer on 3 KW to 15KW units to convert from line voltage to low voltage remote thermostat operation.
- Summer fan switch to operate the fan only.
- Fan delay switch to purge all residual heat from the unit after the heating element has cycled off.
- Powder coated epoxy finish for corrosive atmospheres.
- Disconnect switch.

CONSTRUCTION:

Heavy gauge welded steel cabinet with powder coated finish and control compartment with a hinged and latched access door, simplifying wiring installation & maintenance.

HEATING ELEMENT:

Circular copper clad steel sheath element with continuously brazed steel fins formed to match the air delivery pattern of the fan blade.

OVERHEAT PROTECTION:

All units come equipped with automatic resetting type limit controls to de-energize the heater should an over-temperature situation occur.

FAN and MOTOR:

Totally enclosed, single phase, permanently lubricated, thermally protected motors with unit bearings on 3 KW - 10 KW models and sleeve bearings on 12.5 KW - 48 KW models - mounted with rubber insulators to minimize vibration and noise. Fan assembly enclosed by a heavy gauge, close spaced, chrome plated wire guard.

LOUVER ASSEMBLY:

Louvers are individually adjustable for directional control of air flow and the entire assembly can be repositioned in the field from down flow to up flow or left / right directional air flow.

TEMPERATURE CONTROLS:

20 KW through 48 KW units and all 480V have built in 24 Volt transformer for low voltage remote thermostat application. 25 KW through 48 KW models available in 2-stage on special order (consult factory).

INSTALLATION:

Unit Heaters can be mounted with the motor shaft from horizontal to downward at 45° off horizontal. Pre-drilled holes and installed threaded nuts provided to allow hanging by threaded rods - 1/4" for units up to 15 KW and 5/16" for 20 KW units and larger. Optional wall / ceiling mounting brackets are available for all units.

MAXIMUM RECOMMENDED MOUNTING HEIGHT	
3 - 10 KW	9 FT.
12 - 15 KW	10 FT.
20 - 30 KW	13 FT.
40 - 48 KW	16 FT.

Product Dimensions & Model Number Designation

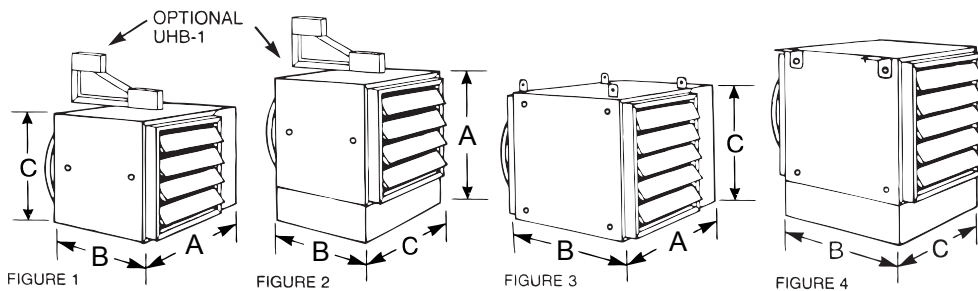

Dimensions	A	B	C
Figure 1: 3.3, 5, 7.5, 10 KW	20"	11"	13"
Figure 2: 12.5, 15 KW	22"	11"	15"
Figure 3: 20, 25, 30 KW	24"	17"	17"
Figure 4: 40, 48 KW	26"	23"	19"

3.3 KW THROUGH 15 KW UNIT HEATERS

20 KW THROUGH 48 KW UNIT HEATERS

Figures 3 & 4 shown with standard mounting tabs for units over 20 KW. Optional UHB-3 and UHB-4 wall brackets are available. 3.3 KW thru 15 KW units can be mounted using 1/4" threaded rod. 20 KW thru 48 KW units can be mounted using 5/16" threaded rod.

HOW TO DESIGNATE A MODEL:

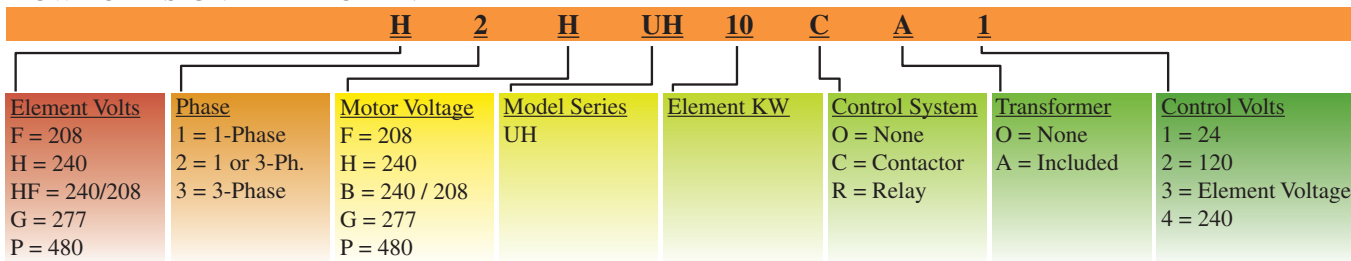

Factory Installed Options (use as a suffix on model designation):
S = Summer Fan Switch, F = Fan Delay, D = Disconnect, T = Built-in Thermostat, E = Epoxy Coated

Field Installed Options:
Disconnect Switch, Built-in Thermostat, & Wall / Ceiling Bracket

UH Series Horizontal Fan Forced Unit Heater

Standard Product Models

UPC# 686334	MODEL	KW	BTU'S	VOLTS	PH	AMPS	CONTROL VOLTS	TEMP RISE °F	AIR THROW	CFM	RECOM'D MOUNTING HT.	WT. (LBS.)	LIST				
644600	F1FUH03003	3.3	11200	208	1	15.9	208	26	26'	400	9'	36	693				
644662	H1HUH03003			240	1	13.8	240										
644723	G1GUH03003			277	1	11.9	277										
711487	H3HUH03C03			240	3	7.9	240										
711494	F3FUH03C03			208	3	9.2	208										
711401	P3PUH03CA1			480	3	4	24										
644617	F1FUH05003	5	17100	208	1	24.1	208	40	26'	400	9'	36	724				
644679	H1HUH05003			240	1	20.8	240										
644730	G1GUH05003			277	1	18.1	277										
644938	F2FUH05C03			208	1 or 3	24.1 / 14.0	208										
644945	H2HUH05C03			240	1 or 3	20.8 / 12.1	240										
644884	P3PUH05CA1			480	3	6.1	24										
718059	F1FUH07CA1	7.5	25600	208	1	36.1	24	42	36'	575	9'	40	1116				
717373	H1HUH07CA1			240	1	31.3	24										
715188	G1GUH07CA1			277	1	27.1	24										
644792	F3FUH07C03			208	3	20.8	208										
644952	H2HUH07C03			240	1 or 3	31.3 / 18.1	240										
644891	P3PUH07CA1			480	3	9.1	24										
717090	F1FUH10CA1	10.0	34100	208	1	48.1	24	55	36'	575	9'	40	1230				
680844	H1HUH10CA1			240	1	41.7	24										
717380	G1GUH10CA1			277	1	36.1	24										
644969	F2FUH10C03			208	1 or 3	48.1 / 27.8	208										
644976	HF2BUH10C03	10 / 7.5	34100	240	1 or 3	41.7 / 24.1	240	55				45					
			25600	208	1 or 3	36.1 / 20.8	208	42									
		10.0	34100	480	3	12.1	24	55				51	1275				
711425	P3PUH10CA1	12.5	42600	208	1	60.1	208	49	45'	800	10'	45	1980				
644648	F1FUH12C03			240	1	52.1	240										
644709	H1HUH12C03			208	3	34.7	208										
644815	F3FUH12C03			240	3	30.1	240										
644860	H3HUH12C03			480	3	15.1	24										
711432	P3PUH12CA1			480	3	15.1	24										
644655	F1FUH15C03	15.0	51200	208	1	72.1	208	59	45'	800	10'	54	2179				
644716	H1HUH15C03			240	1	62.5	240										
644822	F3FUH15C03			208	3	41.7	208										
644877	H3HUH15C03			240	3	36.1	240										
711449	P3PUH15CA1			480	3	18.1	24										
688307	F1FUH20CA1			208	1	96.2	24										
688420	H1HUH20CA1	20.0	68300	240	1	83.3	24	47	56'	1350	13'	55	2991				
688314	F3FUH20CA1			208	3	55.6	24										
688437	H3HUH20CA1			240	3	48.2	24										
688321	P3PUH20CA1			480	3	24.1	24										
688444	F1FUH25CA1			208	1	120.2	24					58	56'	1350	13'	55	3525
688338	H1HUH25CA1			240	1	104.2	24										
688451	F3FUH25CA1	208	3	69.5	24												
688345	H3HUH25CA1	240	3	60.2	24												
688468	P3PUH25CA1	480	3	30.1	24												
688475	H1HUH30CA1	240	1	125	24												
688369	F3FUH30CA1	30.0	102390	208	3	83.4	24	70	56'	1350	13'	60	4081				
688482	H3HUH30CA1			240	3	72.3	24										
688376	P3PUH30CA1			480	3	36.1	24										
688406	P3PUH40CA1			40.0	136500	480	3							48.2	24	55	56'
688789	P3PUH48CA1	48.0	163800	480	3	57.8	24	67	56'	2275	16'	78	6512				

Factory & Field Installed Accessories

FACTORY INSTALLED OPTIONS		
SUFFIX	DESCRIPTION	LIST
F	Heat purge fan delay switch for 208 / 240 / 277V units (includes contactor & transformer)	201
	Heat purge fan delay switch for 480V units (contactor & transformer standard in unit)	117
S	Summer fan switch	58
CA1	24v Transformer (3.3 KW - 15 KW units) & Contactor	147
CA2	120v Transformer (3.3 KW - 15 KW units) & Contactor	
E	Epoxy Coating	111
T	SPST Thermostat	67
D	Disconnect Switch - 30 Amps	281
	Disconnect Switch - 40 Amps	322
	Disconnect Switch - 80 Amps	405
	Disconnect Switch - 100 Amps	411

FIELD INSTALLED ACCESSORIES			
UPC 686334	MODEL	DESCRIPTION	LIST
646239	DCS303	30 Amp Disconnect Kit	240
646246	DCS403	40 Amp Disconnect Kit	282
646253	DCS803	80 Amp Disconnect Kit	370
646260	DCS1003	100 Amp Disconnect Kit	373
687997	TUH1	25 Amp SPST Thermostat Kit	67
699105	UHB-1	wall / ceiling bracket - 3.3 KW - 15 KW units	99
699112	UHB-3	wall / ceiling bracket - 20 KW - 30 KW units	112
699129	UHB-4	wall / ceiling bracket - 35 KW - 48 KW units	142

NOTE: Factory installed heat purge fan delay option (F) requires unit to have CA1 or CA2 factory installed

5100 Series Horizontal or Vertical Mounted Fan Forced Unit Heater

3.3 KW THROUGH 50 KW SUSPENDED FAN FORCED UNIT HEATERS AVAILABLE IN 1 OR 3 PHASE FOR ALL STANDARD VOLTAGES FROM 208V TO 480V THAT CAN BE MOUNTED TO PROVIDE HORIZONTAL OR VERTICAL DISCHARGE.



Horizontal Discharge



Vertical Discharge

Manufactured in U.S.A.

FIELD INSTALLED OPTIONS:

- In-unit or wall mounted temperature control thermostats low or line voltage.
- Summer fan switch to operate the fan only.
- Power disconnect switch.
- Heat stratification thermostat.

CONSTRUCTION:

Heavy 18 gauge welded steel cabinet with powder coated finish and control compartment housing a master terminal board with a hinged and latched access door, simplifying wiring, installation & maintenance.

HEATING ELEMENT:

Copper clad steel sheath element with continuously brazed steel fins formed to allow side draw through air flow.

OVERHEAT PROTECTION:

All units come equipped with automatic reset type limit controls to de-energize the heater should an over-temperature situation occur.

FAN and MOTOR:

Totally enclosed, 1-speed, 1-phase, permanently lubricated, thermally protected motors with unit bearings on 3 KW - 20 KW models. Totally enclosed, 2-speed, 1-phase, permanently lubricated, thermally protected motors with sleeve bearings on 25 KW - 50 KW models. All motors mounted with rubber insulators to minimize vibration & noise. Fan over-ride purges unit of residual heat at shutdown.

LOUVER ASSEMBLY:

Louvers are individually adjustable for directional control of air flow up to 15° from straight horizontal. Optional diffusers available for down flow (vertical discharge) applications.

TEMPERATURE CONTROLS:

Optional low voltage and line voltage thermostats available with an adjustable temperature range of 40°F to 90°F. Units with model numbers ending in CA1 are factory wired for low voltage controls. 25 KW through 50 KW units are designed for two stage heating operation.

INSTALLATION:

Unit Heaters can be mounted for horizontal or vertical discharge. Applications up to 6000 Ft. See UH Series above 6000 Ft. ABS (American Bureau of Shipping) type approved.

Taskmaster Dimensions

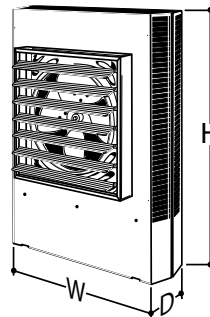

KW RATING	DIMENSIONS (inches)		
	H	W	D
3.3 - 5.0	17 3/4	14 15/32	6 1/2
7.5 - 10.0	24 5/16	21 1/2	6 1/2
15.0 - 20.0	28 11/16	21 1/2	6 1/2
25.0 - 50.0	34	29 1/4	10 1/16

Installing the Taskmaster Series

DETERMINING HEATER REQUIREMENTS

Calculate the heating loads using the NEMA handbook or ASHRAE guide. Then determine the quantity and size of unit heaters to be used. To maintain uniform heat and reduce stratified air, it is recommended that the total CFM of the units turn the air over approximately 3 times per hour. In instances where a large group of people are located and normally in the same area, use a large number of lower KW unit heaters. In warehouse areas or storage rooms where heat distribution and constant temperatures are less important, use fewer heaters of higher capacity.

HORIZONTAL MOUNT

Small rooms can be heated by one unit heater. Where two walls are exposed, heaters should be mounted as shown in Figure A. In larger rooms, units should be located so their air streams wipe exposed walls without blowing at them. Units should be located so that the air stream of one supports that of another thus setting up a circulatory air movement shown in Figure B. (Distance between units to be approximately 1-1/2 times published air throw.) Units should not be mounted horizontally in areas having ceiling heights in excess of 15-18 ft.

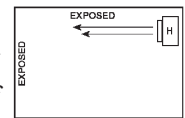

Figure A

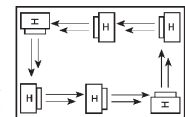

Figure B

VERTICAL MOUNT

Units should be mounted vertically in high bay areas, or where heater location would not interfere with plant operation or traffic. Heaters should be situated to provide free air circulation. Size and selection of units should be based on recommended mounting height. Optional diffusers may best be employed to reduce high air velocity and at the same time disperse heated air in a uniform pattern. When unit heaters are used to combat cold air inrush from opened loading dock doors, one or more units should be arranged to blow warm air across opening (Figure C).

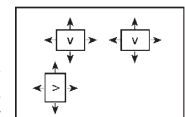

Figure C

DUAL MOUNTING

Where square footage is large and comfort essential, both horizontal and vertical installations may best serve your requirements as Figure D demonstrates.

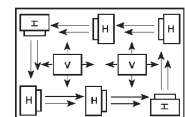

Figure D

Note: Products in this section with factory installed controls are subject to 100% cancellation/restocking charges.

5100 Series Horizontal or Vertical Mounted Fan Forced Unit Heater

Diffuser Options

DESCRIPTION	UPC# 686334	MODEL NUMBER	KW USED	MAX MOUNTING HEIGHT (ft.)		DIMENSION A (feet)		DIMENSION B (feet)	WT. (lbs.)	LIST	
1 Louver Diffuser (Standard). Louvers can be individually adjusted for rectangular coverage over doorways as an air curtain, or to meet rectangular floor pattern heating requirements.	NA	Standard	3.3-5 7.5-10 25-30 40-50	9	20	10	NA	NA	NA		
				12	40	22					
				18	52	30					
				22	75	42					
				24	84	47					
2 General Distribution (No Diffuser). The 5100 air chute venturi permits general down flow air pattern distribution as required at a higher mounting height.	NA	Not Required	3.3-5 7.5-10 25-30 40-50	9	15	NA	NA	NA			
				12	30						
				18	40						
				22	55						
				24	64						
3 Anemostat Diffuser (Optional). For applications where draft restriction is required at lower unit mounting heights.	692687 681186 681186 722070	AD5120 AD5150 AD5150 AD5175	7.5-10 25-30 40-50 60-70	15	38	NA	NA	10	372		
				17	50			12	555		
				20	60			37	598		
				31	-						
4 Radial Diffuser (Optional). Individually adjustable fins permit increased floor coverage at 45° open. Additional throw is accomplished when fins are 90° vertical. (Please allow for higher mounting heights.)	692663 692663 692670 692670 722087	RD5120 RD5120 RD5150 RD5150 RD5175	7.5-20 25-50 60-70	45°	90°	45°	90°	NA	NA	12	412
				10	14	36	30			14	481
				14	21	42	35				
				20	30	62	44				
				18	28	68	54				
				26	36	72	60			39	519

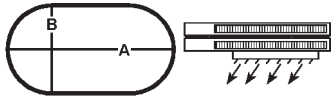
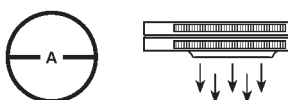
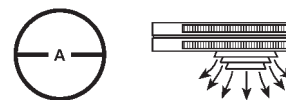
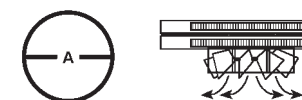
 <p>Description 1 Louver Diffuser</p>	 <p>Description 2 No Diffuser</p>	 <p>Description 3 Anemostat Diffuser</p>	 <p>Description 4 Radial Diffuser</p>
--	--	--	--

Mounting Brackets & Model Designator

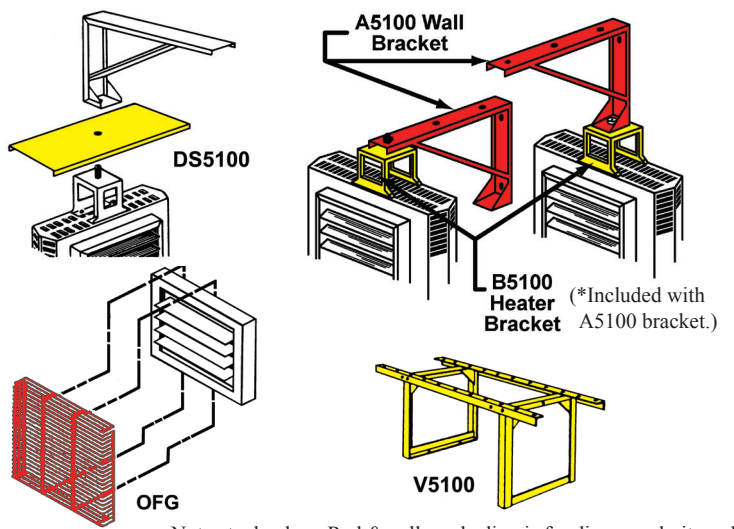

Not actual colors. Red & yellow shading is for diagram clarity only.

MOUNTING BRACKETS				
UPC#	MODEL	MODEL SIZE	WT.	LIST
686334				
692694	A5105	3.3 KW TO 5.0 KW	9 lbs.	96
692700	A5120	7.5 KW TO 20.0 KW	13 lbs.	117
692717	A5150	25.0 KW TO 50.0 KW	16 lbs.	131
688628	B5105*	3.3 KW TO 20.0 KW	3 lbs.	52
688635	B5150*	25.0 KW TO 50.0 KW	8 lbs.	77
692847	V5105	3.3 KW TO 5.0 KW	9 lbs.	183
692854	V5120	7.5 KW TO 20.0 KW	13 lbs.	224
692861	V5150	25.0 KW TO 50.0 KW	16 lbs.	236
DUST SHIELD				
692878	DS5105	3.3 KW TO 5.0 KW	3 lbs.	33
692885	DS5120	7.5 KW TO 20.0 KW	4 lbs.	38
681223	DS5150	25.0 KW TO 50.0 KW	5 lbs.	40
FAN GUARD				
706544	OFG5101	3.3 KW TO 5.0 KW	3 lbs.	53
706551	OFG5102	7.5 KW TO 20.0 KW	4 lbs.	58
706568	OFG5103	25.0 KW TO 50.0 KW	5 lbs.	66

HOW TO DESIGNATE A MODEL:

HF	2	B	51	10	C	A	1
Element Volts F = 208 H = 240 HF = 240/208 G = 277 P = 480	Phase 1 = 1-Phase 2 = 1 or 3-Ph. 3 = 3-Phase	Motor Voltage F = 208 H = 240 B = 240 / 208 G = 277 P = 480	Model Series 51	Element KW	Control System Blank = None C = Contactor	Transformer Blank = None A = Included	Control Volts 1 = 24 2 = 120 (with CA option)

5100 Series Horizontal or Vertical Mounted Fan Forced Unit Heater

Standard Taskmaster Models & Series Notes

UPC# 686334	MODEL	KW	BTU / H	VOLTS	PH	AMPS	CONTROL VOLTAGE	TEMP RISE	AIR THROW	CFM	RECOMMENDED MOUNTING HT.		WT. (LBS.)	LIST							
											Horizontal	Vertical									
645089	F1F5103N	3.3	11.2	208	1	15.9	208	26°F	12'	400	9'	9'	25	693							
645102	HF1B5103N	3.3/2.5	11.2 / 8.5	240/208	1	13.7 / 11.9	240 / 208														
645683	F2F5103N	3.3	11.2	208	1/3	11.9 / 6.9	208														
645706	HF2B5103N	3.3/2.5	11.2 / 8.5	240/208	1/3	13.7 / 11.9	240 / 208														
645720	G1G5103N	3.3	11.2	277	1	11.9	277														
645126	P3P5103CA1N			480	3	4.0	24														
645546	F1F5105N			208	1	24.1	208														
645560	HF1B5105N	5.0/3.7	17.1 / 12.8	240/208	1	20.9 / 18.1	240 / 208								40°F	12'	400	9'	9'	25	724
645140	F2F5105N	5.0	17.1	208	1/3	24.1	208														
645164	HF2B5105N	5.0	17.1	240	1/3	20.8 / 18.1	240														
645843	G1G5105N	3.7	12.8	208	1/3	12.1 / 10.4	208														
645188	P3P5105CA1N	5.0	17.1	480	3	6.1	24														
645201	F2F5107CA1L	7.5	25.6	208	1/3	36.1 / 20.8	24	34°F	22'	700	10'	12'	54	1116							
645225	HF2B5107CA1L	7.5	25.6	240	1/3	27.1 / 31.3															
645928	G1G5107CA1L	5.6	19.2	208	1/3	31.3 / 27.1															
645249	P3P5107CA1N	7.5	25.6	277	1	27.1															
645263	F2F5110CA1L	9.9	33.8	480	3	9.1															
645287	HF2B5110CA1L	10.0	34.1	240	1/3	47.8 / 27.4															
645645	G1G5110CA1N	7.5	25.6	208	1/3	41.2 / 24.0															
645300	P3P5110CA1N	10.0	34.1	277	1	36.1 / 20.8															
645324	F3F5115CA1L	10.0	34.1	480	3	12.1															
645348	HF3B5115CA1L	15.0	51.2	208	3	41.7															
645362	P3P5115CA1N	15.0/11.2	51.2 / 38.4	240/208	3	36.1 / 31.3															
645386	HF3B5120CA1L	15.0	51.2	480	3	18.1															
645409	P3P5120CA1N	19.7/14.8	67.2 / 50.5	240/208	3	47.8 / 41.1															
645881	F3F5125CA1L	20.0	68.3	480	3	24.1															
645942	HF3B5125CA1L	25.0	85.3	208	3	69.5															
645980	P3P5125CA1N	25.0/18.7	85.3 / 64.0	240/208	3	60.2 / 52.1															
645423	F3F5130CA1L	25.0	85.3	480	3	30.1															
645447	HF3B5130CA1L	30.0	102.4	208	3	83.4															
645461	P3P5130CA1N	30.0/22.5	102.4 / 76.8	240/208	3	72.3 / 62.5															
644044	F3F5140CA1L	30.0	102.4	480	3	36.2															
644068	HF3B5140CA1L	40.0	136.5	208	3	111.2															
644082	P3P5140CA1N	40.0/30.0	136.5 / 102.4	240/208	3	96.4 / 83.4															
645485	F3F5150CA1L	39.0	133.1	480	3	47.0															
645508	HF3B5150CA1L	49.6	169.3	208	3	139.0															
645522	P3P5150CA1N	50.0/37.5	170.6 / 128.0	240/208	3	120.5 / 104.3															
645522	P3P5150CA1N	50.0	170.6	480	3	60.3															

International Models

UPC# 686334	MODEL	KW	BTU/H	VOLTS	PH	AMPS	CONTROL VOLTAGE	TEMP RISE	AIR THROW	CFM	RECOMMENDED MOUNTING HT.		WT. (LBS.)	LIST
											Horizontal	Vertical		
715300	Q3H5103CA1	3.3	11263	380	3	5.02	24	26	12'	400	9'	9'	25	693
724920	R3H5103CA1			415		4.6								
724937	Q3H5105CA1			380		7.6								
424944	R3H5105CA1	415	6.96											
717137	Q3H5107CA1	7.5	25600	380	11.4									
724951	R3H5107CA1			415	10.5									
686570	Q3H5110CA1			380	15.2									
724968	R3H5110CA1	10.0	34130	415	13.9									
724975	Q3H5115CA1			380	22.8									
724982	R3H5115CA1			415	20.9									
704175	Q3H5120CA1	20.0	68260	380	30.4									
724999	R3H5120CA1			415	27.85									
719193	Q3H5125CA1			380	38.0									
710619	R3H5125CA1	25.0	85325	415	34.8									
725002	Q3H5130CA1			380	45.6									
710626	R3H5130CA1			415	41.8									
725019	Q3H5140CA1	40.0	136520	380	60.85									
709835	R3H5140CA1			415	55.7									

- For 24V control add "CA1" suffix and \$101 list. • For 120V control add "CA2" suffix and \$101 list.
- For other voltages consult factory.

NOTES:

- 25-50KW models are wired for single or two stage heating and have two speed motors.
- Air delivery and motor data on dual voltage units reflect higher voltage.
- 600 Volt models available in 5 KW through 30 KW. Contact factory for delivery.
- Supply wire on 40 and 50 KW models should have rated insulation of 75°C minimum.
- Use T5122 for two stage control.
- Use TW123 for two stage control.
- Use TFS5102 for two stage control.
- Wall thermostat must be used when built-in stratification thermostat is required.

5100 Series Horizontal or Vertical Mounted Fan Forced Unit Heater

Recommended Control Options, Control Accessory Options, & Control Accessories

MODEL	DISCONNECT SWITCH		THERMOSTAT		SUMMER FAN SWITCH		THERMOSTAT & SUMMER FAN SWITCH WALL MOUNTED	STRATIFICATION THERMOSTAT	
	1 Ø	3 Ø	IN-BUILT	WALL MOUNTED	IN-BUILT	WALL MOUNTED		IN-BUILT	WALL MOUNTED
F1F5103N HF1B5103N	DCS 202	NA	T5100	ET5SS	FS5101	FSW5111	NA	TC5103	TC1602
F2F5103N	NA	DCS 403	T5102	TW 1512					
HF2B5103N	DCS 202 NA	NA DCS 403	T5100 T5102	ET 5SS TW 1512	FS5102	FSW5112	TFS5101	TC5102	NA
G1G5103N	DCS 202	NA	T5100	ET5SS					
P3P5103CA1N	NA	DCS 403		A6176	FS5101	FSW5111	NA	TC5103	TC1602
F1F5105N HF1B5105N	DCS 403	NA	T5100	ET5SS S2025	FS5101	FSW5111	NA	TC5103	TC1602
F2F5105N	NA	DCS 403	T5102	TW 1512					
HF2B5105N	DCS 403 NA	NA DCS 403	T5100 T5102	ET5SS TW 1512	FS5102	FSW5112	TFS5101	TC5102	NA
G1G5105N	DCS 202	NA	T5100	S2025					
P3P5105CA1N	NA	DCS 403		T5100	A6176	FS5101	FSW5111	TC5103	TC1602
F2F5107CA1L	DCS 403 NA	NA DCS 403	T5100			A6176	FS5102	FSW5112	TC5102
HF2B5107CA1L	DCS 403 NA	NA DCS 403		T5100	A6176		FS5101	FSW5111	TC5103
G1G5107CA1L	DCS 403	NA	T5100			A6176	FS5102	FSW5112	TC5102
P3P5107CA1L	NA	DCS 403		T5100	A6176		FS5101	FSW5111	TC5103
F2F5110CA1L	DCS 603 NA	NA DCS 403	T5100			A6176	FS5102	FSW5112	TC5102
HF2B5110CA1L	DCS 603 NA	NA DCS 403		T5100	A6176		FS5101	FSW5111	TC5103
G1G5110CA1N	DCS 403	NA	T5100			A6176	FS5102	FSW5112	TC5102
P3P5110CA1N	NA	DCS 403		T5100	A6176		FS5101	FSW5111	TC5103
F3F5115CA1L	DCS 403	NA	T5100			A6176	FS5102	FSW5112	TC5102
HF3B5115CA1L	DCS 403	NA		T5100	A6176		FS5101	FSW5111	TC5103
P3P5115CA1L	DCS 403	NA	T5100			A6176	FS5102	FSW5112	TC5102
HF3B5120CA1L	DCS 603	NA		T5100	A6176		FS5101	FSW5111	TC5103
P3P5120CA1N	DCS 603	NA	T5100			A6176	FS5102	FSW5112	TC5102
F3F5125CA1L	DCS 1003	NA		T5100	A6176		FS5101	FSW5111	TC5103
HF3B5125CA1L	DCS 403	NA	T5100			A6176	FS5102	FSW5112	TC5102
P3P5125CA1N	DCS 1003	NA		T5100	A6176		FS5101	FSW5111	TC5103
F3F5130CA1L	DCS 1003	NA	T5100			A6176	FS5102	FSW5112	TC5102
HF3B5130CA1L	DCS 403	NA		T5100	A6176		FS5101	FSW5111	TC5103
P3P5130CA1N	DCS 403	NA	T5100			A6176	FS5102	FSW5112	TC5102
F3F5140CA1L	DCS 403	NA		T5100	A6176		FS5101	FSW5111	TC5103
HF3B5140CA1L	DCS 403	NA	T5100			A6176	FS5102	FSW5112	TC5102
P3P5140CA1N	DCS 603	NA		T5100	A6176		FS5101	FSW5111	TC5103
F3F5150CA1L	NA	NA	T5100			A6176	FS5102	FSW5112	TC5102
HF3B5150CA1L	DCS 1003	NA		T5100	A6176		FS5101	FSW5111	TC5103
P3P5150CA1N	DCS 1003	NA	T5100			A6176	FS5102	FSW5112	TC5102

CONTROL ACCESSORY OPTIONS - FIELD INSTALLED IN HEATER			
UPC#	MODEL	DESCRIPTION	LIST
686334			
POWER DISCONNECT SWITCH			
717151	DCS202 / 5100	2 POLE; 20 AMP; 120-277 V.A.C.	134
717168	DCS403 / 5100	3 POLE; 40 AMP; 120-600 V.A.C.	303
717175	DCS603 / 5100	3 POLE; 60 AMP; 120-600 V.A.C.	442
717182	DCS1003 / 5100	3 POLE; 100 AMP; 120-600 V.A.C.	497
LINE VOLTAGE THERMOSTAT (45 - 90 °F)			
692779	T5100	SPST; LINE DUTY 25 AMP 120-277V	121
692786	T5102	DPST; LINE DUTY 25 AMP 120-277V	164
LOW VOLTAGE THERMOSTAT (ALL CA1 MODELS) (45 - 90 °F)			
692779	T5100	SPST; LOW VOLT/PILOT DUTY; 125VA; (3.3-20 KW UNITS)	121
692793	T5122	2-STAGE; LOW VOLT; 125VA; (25-50 KW UNITS)	180
STRATIFICATION THERMOSTAT			
692809	TC5102	SPST; LOW VOLT/PILOT DUTY (W/ RELAY) ; 70-130°	184
692816	TC5103	SPST; LINE DUTY; AMP 120-240V; 70-130°	123
SUMMER FAN SWITCH			
692823	FS5101	SPST; LINE VOLT ;120-277V	69
692830	FS5102	SPST; LINE VOLT ; 480-600V	100

CONTROL ACCESSORIES - REMOTE WALL MOUNTED			
UPC#	MODEL	DESCRIPTION	LIST
686334			
LINE VOLTAGE THERMOSTAT			
502917	S2025H10AA	SP; 25 Amp; 120-277V; 50-90°F	51
538787	ET5SS	SP; 22 Amp; 120-277V; 50-90°F	27.30
691093	*TW1512	DPST; 25 AMP; 120-277V; 50-90°F	196
LOW VOLTAGE THERMOSTAT (ALL CA1 MODELS)			
260008	A6176	SPST; (3.3 - 20 KW UNITS); 50-90°F	104
691116	TW123	2-STAGE; (25 - 50 KW UNITS); 40-90°F	200
STRATIFICATION THERMOSTAT			
691109	TC1602	SPST; LINE VOLT; 120-277V; 70-140°	197
SUMMER FAN SWITCH			
692625	FSW5111	SPST; LINE VOLT; 120-277V	86
692632	FSW5112	SPST; LOW VOLT; (W/RELAY)	186
LOW VOLTAGE T' STAT & SUMMER FAN SWITCH(W/RELAY) (CA1 MODELS)			
692649	TFSS101	SPST; LOW VOLT; 50-90°	200
692656	TFSS102	2-STAGE; LOW VOLT; 50-90°	401

** Any SPST thermostat of sufficient amperage may be substituted.
*Use DPST thermostat for 3-phase line voltage control in non "C" models.



Manufactured in U.S.A.

Features & Specifications

CONSTRUCTION:

Heavy gauge steel cabinet with powder coated finish and control compartment housing a master terminal board. The control compartment allows for access through a hinged and latched door, simplifying wiring, installation, and maintenance.

HEATING ELEMENT:

The heating element is a copper clad steel sheath element with continuously brazed steel fins formed to allow side draw through air flow.

OVERHEAT PROTECTION:

All units come equipped with manual reset type limit controls to de-energize the heater should an over-temperature situation occur.

FAN & MOTOR:

Single speed, single phase permanently lubricated, thermally protected motors with ball bearings. The fan override purges the unit of residual heat at shutdown.

FIELD INSTALLED OPTIONS:

Summer fan switch to operate the fan only, and a heat stratification thermostat for high bay areas.

HEATER STAGING:

60 KW and 70 KW are three stage; 80 KW, 90 KW, & 100 KW are four stage.

SC5100 FACTORY INSTALLED ELECTRONIC STEP CONTROLLER:

The optional factory installed step controller is a first on last off sequencer that will cycle the unit heater stages through an optional wall thermostat. Additionally, the step controller can be controlled by any building management system with 4 to 20 MA or 0 - 10 VDC field supplied control signal.

Optional Factory Installed Electronic Step Controller

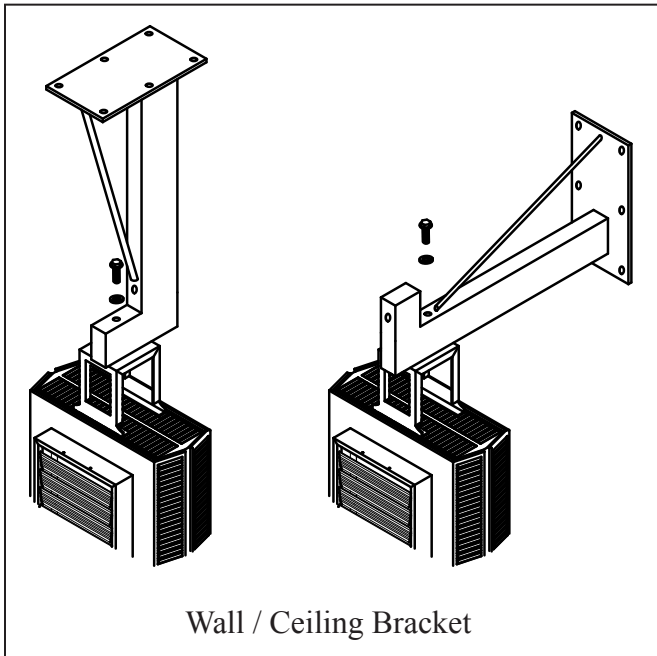
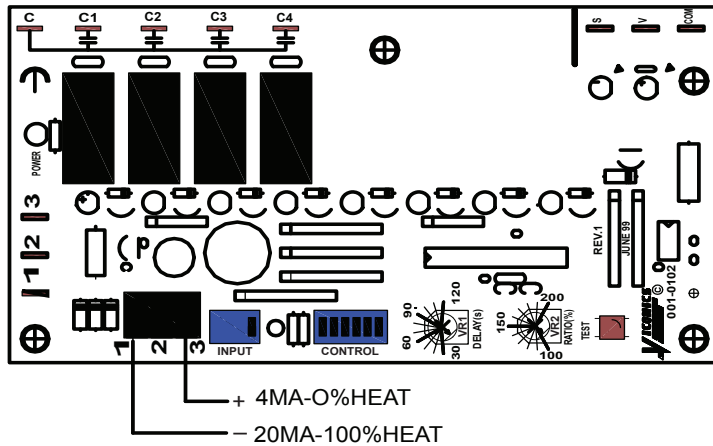

Dimensions

Dimensions (Inches)				WT (LBS.)
KW	H	W	D	
60-70	35 1/2	30 1/2	14 1/2	141
80-100	39 1/2	37 5/8	18 1/2	202

Mounting Brackets and Accessories

Mounting Brackets				
UPC# 686334	Model	Heater KW	Description	LIST
7220002	A5175	60 To 70	Wall/Ceiling Bracket	181
7220102	A51100	80 to 100		189
7220302	B5175	60 to 70	Heater Bracket	82
7220402	B51100	80 to 100		101
7220202	V51100	60 to 100	Vertical Bracket	314
7220502	DS5175	60 to 70	Dust Shield	49
7220602	DS51100	80 to 100		57
7220902	OFG 5175	60 to 70	Fan Guard	78
7221002	OFG 51100	80 to 100		97

5100 Series 60 KW - 100 KW Suspended Fan Forced Unit Heater

Electrical Data

UPC# 686334	Catalog Number	KW	BTU/HR (x 1000)	Voltage	Phase	Control Voltage	Amps / Phase	Branch Circuit Protection Size	LIST
721349	F3F5160CA1	60	204.7	208	3	24	166.7	225	8135
721356	HF3B5160CA1	60/45	204.7/153.6	240/208			144.6/125	200/175	
721363	P3P5160CA1	60	204.7	480			72.3	100	
721424	F3F5170CA1	70	238.9	208	3	24	194.4	250	8480
721431	HF3B5170CA1	70/52.5	238.9/179.2	240/208			168.7/145.8	225/200	
721448	P3P5170CA1	70	238.9	480			84.3	110	
721707	HF3B5180CA1	80/60	273/204.7	240/208	3	24	192.8/166.7	250/225	9912
721714	P3P5180CA1	80	273	480			96.3	125	
721769	HF3B5190CA1	90/67.5	307.1/230.4	240/208	3	24	216.9/187.5	300/250	10312
721776	P3P5190CA1	90	307.1	480			108.4	150	
721820	HF3B51100CA1	100/75	341.3/256	240/208	3	24	241/208.3	350/300	10886
721837	P3P51100CA1	100	341.3	480			120.4	175	

Air Delivery Data

UPC# 686334	Catalog Number	CFM at Outlet	FPM at Outlet	Temp Rise °F	HP	Motor RPM	Air Throw	Max Mounting	
								Horizontal	Vertical
721349	F3F5160CA1	3400	1485	60	1/3	1100	50'	18'	31'
721356	HF3B5160CA1			60/45					
721363	P3P5160CA1			60					
721424	F3F5170CA1			70					
721431	HF3B5170CA1			70/53					
721448	P3P5170CA1			70					
721707	HF3B5180CA1	5000	1529	55/41	3/4	1100	65'	22'	40'
721714	P3P5180CA1			55					
721769	HF3B5190CA1			61/46					
721776	P3P5190CA1			61					
721820	HF3B51100CA1			68/51					
721837	P3P51100CA1			68					

Recommended Control Options

UPC# 686334	Catalog Number	Step Controller		Thermostat		Summer Fan Switch				Stratification Thermostat				
		Model	List	Model	List	Wall		Built-In		Wall		Built-In		
						Model	List	Model	List	Model	List	Model	List	
721349	F3F5160CA1	SC5100	654	C1025	194	FSW5112	186	FS5101	71	TFS5101	200	TC5102	184	
721356	HF3B5160CA1							FS5101						
721363	P3P5160CA1							FS5102						104
721424	F3F5170CA1							FS5101						71
721431	HF3B5170CA1							FS5101						71
721448	P3P5170CA1							FS5102						104
721707	HF3B5180CA1							FS5101						71
721714	P3P5180CA1							FS5102						104
721769	HF3B5190CA1							FS5101						71
721776	P3P5190CA1							FS5102						104
721820	HF3B51100CA1							FS5101						71
721837	P3P51100CA1							FS5102						104

Note: Products listed in this section are custom built and subject to 100% cancellation/restocking charges.

2600 Series Downflow Unit Heater

General Description & Diffuser Information

CONSTRUCTION:

- 16 gauge steel cabinet with epoxy powder coated finish and control compartment with a hinged and latched access door.
- OSHA guards standard with all models.

HEATING ELEMENT:

- Corrosion resistant element with steel sheath and steel spiral fins.

OVERHEAT PROTECTION:

- All units come equipped with manual reset limit controls to de-energize the heater should an over-temperature situation occur.

FAN and MOTOR:

- Totally enclosed, 1 speed, 1 phase permanently lubricated, thermally protected motors with unit bearings on 3KW - 20KW models. Totally enclosed, 2 speed, 1 phase permanently lubricated, thermally protected motors with sleeve bearings on 24KW - 50KW models.
- Axial flow fan blade - 1570 RPM max.
- All models equipped with fan purge which allows fan to operate after elements are de-energized to purge residual heat.

TEMPERATURE CONTROLS:

- 208V, 240V, 277V and 480V units have In-Built 24 Volt transformer for low voltage remote thermostat application.
- 600V units have In-Built 240V control on 5-20 KW models, 25-50 KW models have 24V control.
- 25 KW - 50 KW models may operate as 2 stage heaters if 2 stage remote thermostat is used.

DISCONNECT SWITCH:

- All models equipped with In-Built disconnect except F3F2640, F3F2650 and H3H2650.

INSTALLATION:

- Unit can be mounted using optional mounting bracket or field constructed angle iron bracket.
- Not recommended for mounting with threaded rod or chain.



Manufactured in U.S.A.

2600 Series shown with standard wire guard. Diffusers are field installed.

Diffuser Descriptions	Standard Heater			Radial Louvered Cone Diffuser			Linear Louvered Diffuser			Anemostat Diffuser														
	<table border="1"> <thead> <tr> <th colspan="3">Dimensions**</th> </tr> <tr> <th>KW</th> <th>B</th> <th>A</th> </tr> </thead> <tbody> <tr> <td>5-20</td> <td>20 1/2"</td> <td>15"</td> </tr> <tr> <td>25-50</td> <td>27"</td> <td>21 1/2"</td> </tr> </tbody> </table>			Dimensions**			KW	B	A	5-20	20 1/2"	15"	25-50	27"	21 1/2"									
	Dimensions**																							
KW	B	A																						
5-20	20 1/2"	15"																						
25-50	27"	21 1/2"																						
<p>For general distribution. Choice of other diffusers may be added after installation if required.</p> <p>O.S.H.A guard for fan blade D1604 for 2605-2620, & D1614 for 2625-2650 Do not use with other diffusers.</p>			<p>With vanes vertical, straightens air for higher mounting. Closed position for broad horizontal coverage. Adjustable for intermediate requirements.</p>			<p>Affords more precise directional throw where heaters cannot be mounted directly over area to be heated or for heating long narrow areas.</p>			<p>Blends room air with heated air for widespread distribution without excessive drafts.</p>															
			VERTICAL			45 DEGREES OPEN																		
MODEL	MAX MOUNTING HEIGHT*	D (ft.)	MAX MOUNTING HEIGHT	D (ft.)	MAX MOUNTING HEIGHT	D (ft.)	MAX MOUNTING HEIGHT	W (ft.)	L (ft.)	MAX MOUNTING HEIGHT	D (ft.)													
2605	10	25	15	25	8	30	10	10	40	9	25													
2607	10	25	15	25	8	30	10	10	40	9	25													
2610	22	40	26	36	15	44	22	14	54	20	38													
2615	20	44	24	38	14	46	20	14	60	18	40													
2620	18	48	22	40	13	50	18	15	66	16	42													
2625	32	48	38	42	24	70	34	30	80	30	60													
2630	30	60	36	50	22	74	32	34	80	28	64													
2640	26	64	32	50	20	78	30	36	90	26	67													
2650	24	68	28	50	18	82	28	40	100	24	70													

*Minimum mounting height 6 feet.

**Dimensions are for all heater models without a diffuser option. Adding a diffuser will change the vertical ("A") dimension of heater. All mounting distances are in feet. All diagrams show optional mounting bracket.

2600 Series Downflow Unit Heater

Product Specifications

SPECIFICATIONS: The contractor shall furnish and install the 2600 Series electric vertical discharge unit heaters of the size, capacity and voltage specified. Heaters shall be installed according to the manufacturer's recommendations and applicable national and local codes.

ELEMENTS: Elements shall consist of Nickel Chromium alloy resistance wire embedded and completely surrounded in Magnesium Oxide, enclosed and swagged into corrosion resistant sheaths. Corrosion resistant steel fins shall be permanently attached to the sheaths to provide maximum heat transfer to the air stream.

MOTORS: Motors shall be single phase, resilient mounted, totally enclosed, industrial rated with an automatic reset thermal overload protective device. Motors on heaters up to 20 KW capacity shall be permanently lubricated shaded pole type. Over 20 KW, motors shall be permanent split capacitor type. Motors shall be mounted out of the main air stream in such a manner as to allow ambient air to be drawn over the motor to reduce motor temperature. Motor shall be separately removable from beneath the heater without removing the entire heater from mounting bracket.

FAN BLADES: Fan blades shall be heavy-duty individually balanced axial flow type. Fan speed shall not exceed 1570 RPM.

THERMAL OVERLOAD PROTECTION: All heaters shall be equipped with a manual reset thermal cutout which disconnects elements and motor in the event normal operating temperatures are exceeded.

WIRING: Heaters shall be designed for a single supply circuit with elements, motor and control circuits subdivided and fused to conform with the latest National Electric Code and OSHA requirements. All three phase heaters shall have balanced phases.

CONTROLS: Heaters shall be controlled by a low voltage wall mounted thermostat. All heaters 25 KW and larger shall be wired for 2 stage operation. 5 KW through 20 KW units are single stage. All heaters shall be equipped with a fan safety device that causes fan to operate after elements are de-energized to purge unit of residual heat.

Standard Models

UPC# 686334	MODEL	KW	BTU's	VOLTS	PH	AMPS	CONTROL VOLTS	TEMP RISE °F	CFM	WT (LBS.)	LIST							
715751	F1F2605CA1	5	17065	208	1	24.03	24	34	490	75	1129							
715768	H1H2605CA1			240		20.83												
715775	G1G2605CA1			277		18.05												
715782	F3F2605CA1			208	3	13.89						240						
715799	H3H2605CA1			240		12.04												
715805	P3P2605CA1			480		6.02												
715812	U3H2605CA4			600	4.81	1381												
715829	F1F2607CA1	7.5	25598	208	1	36.05	24	45	560	75	1452							
715836	H1H2607CA1			240		31.25												
715843	G1G2607CA1			277		27.07												
715850	F3F2607CA1			208	3	20.84						240						
715867	H3H2607CA1			240		18.06												
715874	P3P2607CA1			480		9.03												
715881	U3H2607CA4			600	7.22	1595												
715898	F1F2610CA1	10	34130	208	1	48.07	24	26	1200	75	1988							
715904	H1H2610CA1			240		41.66												
715911	G1G2610CA1			277		36.1												
715928	F3F2610CA1			208	3	27.79						240						
715935	H3H2610CA1			240		24.08												
715942	P3P2610CA1			480		12.04												
715959	U3H2610CA4			600	9.63	2345												
715966	F3F2615CA1	15	51195	208	1	41.68	24	39	1200	75	2273							
715973	H3H2615CA1			240		36.12												
715980	P3P2615CA1			480		18.06												
715997	U3H2615CA4			600	14.45	2559												
716000	H3H2620CA1			19.4	68260	240						3	48.16	24	52	1200	75	2631
716017	P3P2620CA1			20		480							24.08					
717502	U3H2620CA4			600		19.26							3096					
717519	F3F2625CA1	25	85325	208	1	69.48	24	24	3300	175	3499							
717526	H3H2625CA1			240		60.21												
717533	P3P2625CA1			480		30.1												
717540	U3U2625CA1			600	24.08	4356												
717557	F3F2630CA1			30	102390	208						3	83.37	24	29	3300	175	3820
717564	H3H2630CA1					240							72.25					
717571	P3P2630CA1					480							36.12					
717588	U3U2630CA1	600	28.9			5431												
717595	F3F2640CA1	40	136520			208	1	111.17	24	38	3300	175	5073					
717601	H3H2640CA1					240		96.33										
717618	P3P2640CA1					480		48.16										
717625	U3U2640CA1			600	38.53	6146												
717632	F3F2650CA1			50	170650	208	3	138.96						24	48	3300	175	5787
717649	H3H2650CA1					240		120.42										
717656	P3P2650CA1					480		60.21										
717663	U3U2650CA1	600	48.16			6861												

2600 Series Downflow Unit Heater

Field Installed Accessories

UPC# 686334	MODEL	DESCRIPTION	LIST
692632	FSW5112	Summer Fan Switch	186
691109	TC1602	Wall Mounted Stratification Thermostat Range - 70 °F - 140 °F	184
717755	A1600	Ceiling Mount Bracket 5-20 KW Models	120
717762	A1601	Ceiling Mount Bracket 25-50 KW Models	134

UPC# 686334	MODEL	DESCRIPTION	LIST
717793	D1602	Linear Louvered Diffuser 5-20 KW Models	401
717809	D1612	Linear Louvered Diffuser 25-50 KW Models	598
717816	D1600	Radial Louvered Cone Diffuser 5-20 KW Models	444
717823	D1610	Radial Louvered Cone Diffuser 25-50 KW Models	519
717830	D1603	Anemostat Diffuser 5-20 KW Models	401
717847	D1613	Anemostat Diffuser 25-50 KW Models	598

5700 Series Confined Space Plenum Rated Heater



Features

- Easily fits between joists for typical installation.
- Zero clearance for wall and ceiling mounting as well as floor mounting with appropriate inlet and outlet clearances.
- Bracket standard or can be mounted by 3/8" threaded rod (field supplied)
- Automatic reset thermal limit for safety
- 1 Phase model wattage field changeable from 1874 to 5000 Watts.
- 24V control circuit on three phase models with hydraulic thermostat

Conforms to ANSI/UL 1995
 Certified to CAN/CSA C 22.2 No.236-11

Product Dimensions

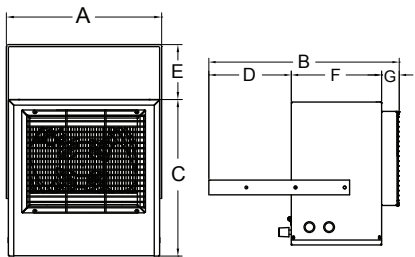

A	B	C	D	E	F	G
14.4"	19.4"	14.5"	8.4"	5.1"	9.2"	1.8"

Standard Models

UPC# 686334	MODEL	WATTS	BTU's	VOLTS	PHASE	AMPS	TEMP RISE	AIR THROW	CFM	WT. (LBS.)	LIST
726245	HF5705T	5000	17065	240	1	21	57 °F	16'	275	32	772
		4165	14215			17	48 °F				
		3332	11365			14	38 °F				
		2500	8533			10	29 °F				
		3750	12798	208	1	18	43 °F	16'	275	32	
		3123	10659			15	36 °F				
		2500	8553			12	29 °F				
1874	6396	9	21 °F								
727252	H3H5705T	3750	12799	208	3	10.4	57 °F	16'	375	32	832
		5000	17065	240	3	12	57 °F	16'	275	32	
726269	P3P5705T	5000	17065	480	3	6	57 °F	16'	275	32	
707367	DCS-MT303	Optional Field Installed Disconnect Switch, 30 Amp @ 600Volts									63
For 24V control on single phase models delete "T" suffix											146

5600 Series Multiple Wattage Fan Forced Unit Heater

Product Specifications

CASING: Fabricated of die formed, heavy gauge steel and finished with two tone, brown and beige, durable powder coated paint. Supply air is drawn through the rear heavy duty expanded steel inlet grill. Heated air is discharged through front adjustable louvers, which are spring loaded for individual adjustment.

ELEMENT: Heavy-duty block fin element design. The multiple tap electric connection design allows field conversion to eight wattage settings at 208/240-Volt single phase or 240/480 Volt, 3 phase. Units are available on special order with a specific wattage/voltage setting.

MOTOR: Motor shall be totally enclosed, permanently lubricated, all angle industrial rated with thermal overload protection.

WIRING: Wiring to terminal block adjacent to incoming knockout in accordance with NEC and local codes.

THERMAL OVERLOAD: All heaters shall be equipped with an automatic reset thermal cutout to shut down the element and motor circuits if unsafe operating temperatures are exceeded.

CONTROLS: The heater shall have a heavy-duty hydraulic thermostat factory installed and wired. All controls and wiring shall be in a large wiring compartment with hinged door for easy access. An optional disconnect switch shall be available for field installation.

MOUNTING: Heaters are standard with a three position-mounting bracket for wall, ceiling or workbench. Heaters can be mounted for horizontal or vertical discharge. Note: Minimum mounting height is 6 feet, and minimum distance from side of heater to nearest wall is 6 inches. Note: Approved for residential applications.



Front view

Manufactured in U.S.A.



Product Dimensions

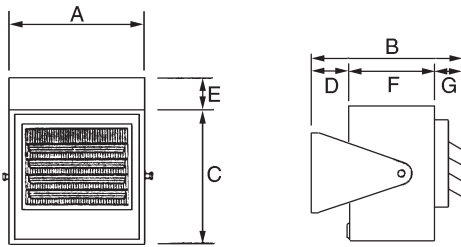

A	B	C	D	E	F	G
14"	12-11/16"	14"	1-9/16"	1-9/16"	9"	2-3/4"

Standard Models

UPC# 686334	MODEL	WATTS	BTU's	VOLTS	PHASE	AMPS	TEMP RISE	AIR THROW	CFM	WT. (LBS.)	LIST
707282	HF5605T	5000	17065	240	1	21	57 °F	16'	275	32	772
		4165	14215			17	48 °F				
		3332	11365			14	38 °F				
		2500	8533			10	29 °F				
		3750	12798	208	1	18	43 °F	16'	275	32	
		3123	10659			15	36 °F				
		2500	8553			12	29 °F				
1874	6396	9	21 °F								
707299	H3H5605T	3750	12799	208	3	10.4	57 °F	16'	375	32	832
		5000	17065	240	3	12	57 °F	16'	275	32	
707305	P3P5605T	5000	17065	480	3	6	57 °F	16'	275	32	
707367	DCS-MT303	Optional Field Installed Disconnect Switch, 30 Amp @ 600Volts									63
For 24V control on single phase models delete "T" suffix											146

6300 Series Multiple Angle Cabinet Unit Heater

Product Specifications

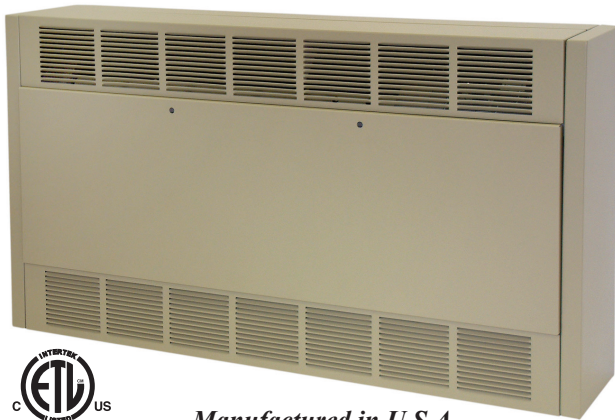

Manufactured in U.S.A.

The electric cabinet unit heater is designed for mounting in any position, fully recessed, semi-recessed or surface mounted. All capacities, voltages, physical sizes, grille arrangements and options shall be as specified on the plans. All units must be field convertible to the following:

1. For control by a field supplied remote thermostat.
2. Load management control with an external dry switch.
When closed unit operates under control of either the internal or the external thermostat. When open, unit turns off.
3. Any grille arrangement.

CABINET: The cabinet shall be constructed of heavy duty 16 gauge Zinc coated steel. The heater shall have a removable front door for easy access to the control panel, elements, motor-blower assembly,

filters and all internal components. The grill configuration must be easily field convertible to any air flow configuration (by removal of no more than four fasteners). The cabinet shall have a textured finish of two coats of powder coat epoxy and be suitable for use with optional kick space base.

HEATING ELEMENTS: The heating elements shall be warranted for 1 year and shall be non-glowing design consisting of special high temperature resistance wire enclosed in an incoloy sheath to which steel fins are furnace brazed. The heating elements shall be located directly in front of the blower discharge air for uniform heating. They shall be mounted with a single anchor at one end to minimize effects of thermal expansion and contraction.

SAFETY CUTOFF: Thermal safety limits shall be built into the system to automatically shut off heater in event of overheating due to any cause. The safety cutouts shall be of two types:

- A. The primary limit shall be an automatic capillary type to sense the heat along the full length of the heating elements. It shall de-energize the heaters by opening the coil circuit on the heating contactors.
- B. The secondary limit shall be a manual reset thermal device to interrupt power to the heating elements.

MOTOR AND BLOWER ASSEMBLY: The motors and blowers shall be direct drive and resiliently mounted on rigid heavy gauge frame for quiet operation and long life. The motor shall be two-speed, shaded pole type, rated for the voltage (480 to 600 Volts are single speed only). Each shall have built-in automatic reset overload protection and are life time lubricated. The motor shall be vented and mounted in the air stream to provide maximum cooling of the motor.

HIGH AND LOW HEAT RANGES: All units will be supplied as standard with a switch for selecting full heat at high fan speed or reduced heat at low fan speed (On 480 & 600 Volt units the switch changes the heat but not the fan speed).

OVER CURRENT PROTECTION: Circuit breakers shall be provided for branch circuit protection where required by NEC. Circuit breakers are optional on all other heaters.

TEMPERATURE CONTROL: Integral factory installed thermostat shall be tamper resistant, linear capillary type.

Mounting Configurations

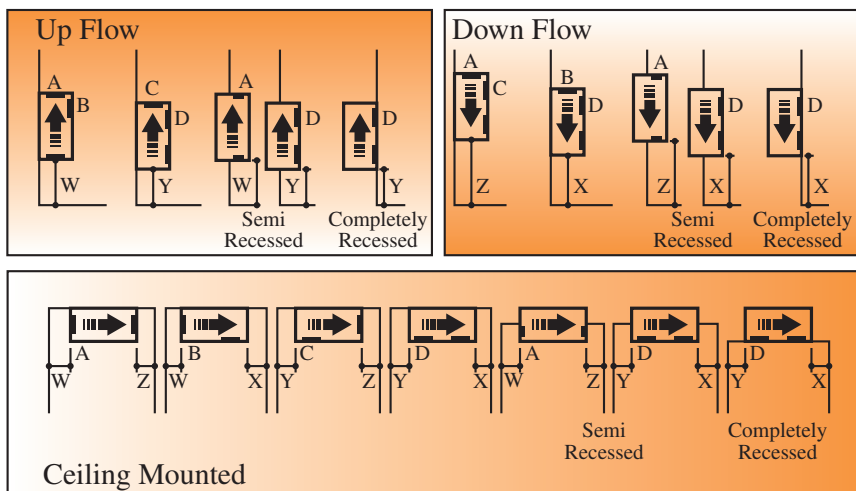

KEY: W = 6" minimum, X = 12" minimum, Y = 0" or greater, Z = 24" minimum

NOTE: Semi-recessed units are to be recessed at a maximum of 3 1/2" unless grill configuration is front in and front out.

MOUNTING CLEARANCES: Proper clearances are indicated for each mounting configuration on all positions. Minimum clearance from side of unit to the wall is zero inches. Mounting inches are provided in the back of the cabinet, accessible through the blower compartment, if necessary, remove blower deck if additional mounting screws or bolts are desired. Blower deck may be slipped forward by loosening four screws at the front to provide access to mounting holes.

6300 Series Multiple Angle Cabinet Unit Heater

Product Features (2-24 KW; All Voltages)

- For commercial and institutional application such as stores, schools, offices, transportation terminals, churches, entrance ways.
- Wall or ceiling mount; surface, semi-recessed or fully recessed.
- (8) air inlet and outlet configurations.
- Capacities from 2-24 KW with 230 to 1,000 CFM
- Motors are two speed, shaded pole, resilient mounted, direct drive. High/low heat and blower speed offer versatility.
- ETL Listed.
- Beige powder coated finish
- Choice of eight standard control options include unit or wall mounted 120 or 24V thermostats, with or without built-in control transformers.
- Industrial type finned tubular elements.
- Easily removable fan and element decks for simplified maintenance.
- Full length thermal protection.
- Limited warranty-one year.

Product Dimensions

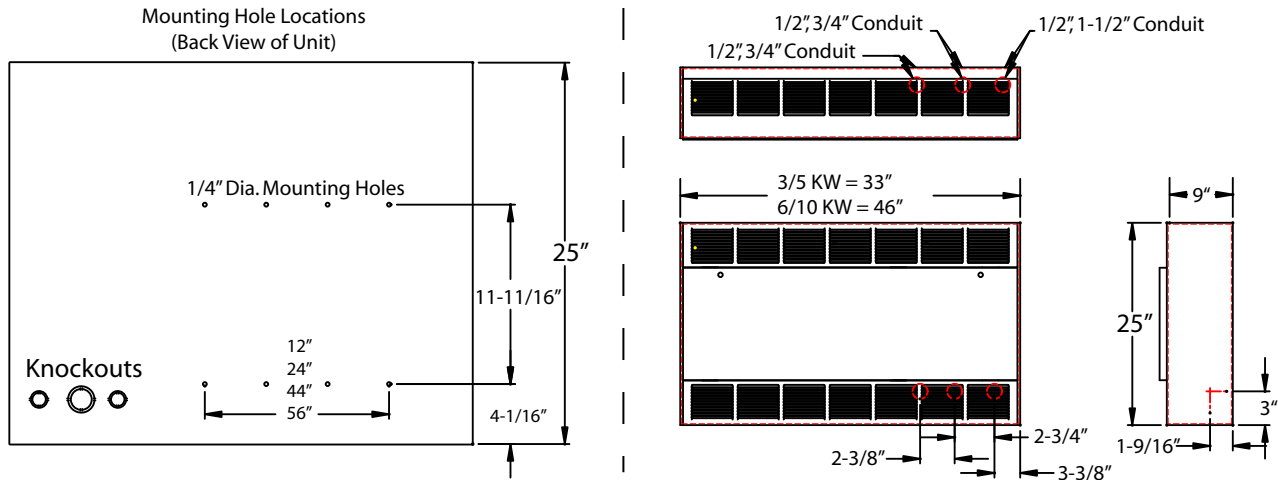

Stocked Models & Features

HEATER LENGTH	UPC# 686334	MODEL	HIGH				LOW				VOLTS	PHASE	Wt. (lbs.)	LIST
			KW	BTU's	AMPS	CFM	KW	BTU's	AMPS	CFM				
33"	667142	6333D052033B30D0F	5	17065	25.0 / 17.6	250	3	10239	15.4 / 9.2	230	208	1-3*	99	3105
	667159	6333D052433B30D0F			21.8 / 15.4				13.5 / 8.2		240	1-3*		
	667081	6333D054833B30D0F			7.8				4.6		480	3		
46"	667197	6346D102433B30D0F	10	34130	43.6 / 30.7	500	6	20478	26.9 / 16.2	460	240	1-3*	130	3502
	667203	6346D104833B30D0F			15.4				8.1		480	3		
International Models														
33"	473620	6333D053834B30D0F1	5	17065	7.6	250	3	10239	4.56	230	380	3	99	3105
	473637	6333D054134B30D0F1			6.97				4.18		415			
46"	473644	6346D103834B30D0F1	10	34130	15.2	500	6	20478	9.12	460	380	(4-Wire)	130	3502
	473651	6346D104134B30D0F1			13.94				8.36		415			

*Factory wired for 3-phase, field convertible to 1-phase.

- 1 / 3 phase field convertible with 24 Volt control circuit.
- Disconnect switch, dust filter, & high low operation.
- Built-in thermostat and field convertible for remote thermostat.

Accessories

UPC# 686334	MODEL	SIZE	DESCRIPTION	LIST
DUCT COLLAR				
441568	DC-33	33"	The same model is used for the inlet or outlet. If duct collars are required for both inlet & outlet then 2 must be ordered.	177
441575	DC-46	46"		215
441582	DC-66	66"		269
441599	DC-79	79"		328
RECESSING TRIM FRAMES				
453783	TF-33	33"	Recessing Trim Frames should be ordered to "trim-out" any recessed or semi-recessed installation.	160
453790	TF-46	46"		180
453806	TF-66	66"		224
453813	TF-79	79"		247

UPC# 686334	MODEL	SIZE	LIST
Fresh Air Make-Up Intake Flange & Kickbase			
771580	FAM33	33"	349
771597	FAM46	46"	402
771603	FAM66	66"	620
771610	FAM79	79"	681
Kickbase (Pedestal) ONLY			
771542	KB33	33"	139
771559	KB46	46"	147
771566	KB66	66"	178
771573	KB79	79"	194

6300 Series Multiple Angle Cabinet Unit Heater

Custom Specified Models

HOW TO DESIGNATE A MODEL:

63	46	D	08	24	1	2	B3	S	D	O	F
Series Number	Cabinet Size 33=33" 46=46" 66=66" 79=79"	Air Flow Configuration A = Bottom in / Top out B = Bottom in / Front out C = Front in / Top out D = Front in / Front out	Element KW 2KW through 24KW See model chart for length and KW options.	Element Voltage 20 = 208V 24 = 240V 27 = 277V 41 = 415V 48 = 480V 57 = 600V	Phase 1 = Single Phase 3 = Three Phase	Number of Wires in Electrical Service 2 or 3	Control Options B3, B4, B5, B6 (see control options chart)	Summer Fan Switch S = Included O = Not Included	Disconnect Option D = Disconnect Switch O = None	Motor Fusing Option M = Required O = Not Required	Disposable Filter Option F = Required O = Not Required
Step 1	Step 2	Step 3	Step 4	Step 5	Step 6	Step 7	Step 8	Step 9	Step 10	Step 11	Step 12

LENGTH	KW		Elements per Heat Deck		CFM		1-PHASE UNITS - AMPS (HIGH)				3-PHASE UNITS - AMPS (HIGH)			LIST	
	High	Low	Left	Right	High	Low	208V	240V	277V	600V	208V	240V	480V		600V
													3-WIRE		
33"	2	1	2		250	230	10.6	9.3	8.12	3.83	9.22	8.13	4.14	3.33	2514
	3	2	3				15.4	13.5	11.7	5.5	9.22	8.13	4.14	3.38	2589
	4	2	4				20.2	16.7	15.3	7.2	13.4	11.8	6	6.22	2692
	5	3	5				25	21.8	19	8	17.6	15.4	7.8	5.5	2814
	6	3	6				29.9	26	22.6	10.5	17.6	15.4	7.8	6.3	2935
46"	4	2	2		500	460	21.1	18.6	16	7.46	18.7	16.2	8.1	6.5	2865
	6	4	3				30.8	26.9	23.1	10.79	18.4	16.2	8.1	6.5	2993
	8	4	4				40.4	35.2	30.5	14.12	26.7	23.4	11.7	9.4	3131
	10	6	5				50	43.6	37.7	17.5	35.1	30.7	15.4	12.3	3258
	12	6	6				59.6	51.9	44.9	20.8	35.1	30.7	15.4	12.3	3325
66"	6	3	2	2	750	690	31.8	27.9	24.1	11.3	27.6	24.3	12.3	9.8	3642
	9	6	3	3			46.2	40.4	35	16.3	27.6	24.3	12.3	9.9	3791
	12	6	4	4			60.6	52.9	45.8	21.3	40.1	35.2	17.7	15.6	3938
	15	9	5	5			75	65.4	56.7	25.5	52.6	46.1	23.1	15.7	4075
	18	9	6	6			89.4	77.9	67.5	31.3	52.6	46.1	23.1	18.5	4222
79"	8	4	2	2	1000	920	42.3	37.1	32	14.9	36.7	32.3	16.2	13	4075
	12	8	3	3			61.5	53.8	46.5	21.6	36.7	32.3	16.2	13	4164
	16	8	4	4			80.7	70.5	61	28.2	53.4	46.8	23.5	18.8	4323
	20	12	5	5			NA	87.1	75.4	34.9	70.1	61.4	30.7	24.6	4392
	24	12	6	6			NA	NA	89.8	41.6	70.1	61.4	30.7	24.6	4471

Note: Amps include motor Amp loads. Note: Please see page 60 for custom color availability - add 10% to net heater cost.
 Note: Products listed in this section are custom built and subject to 100% cancellation/restocking charges.

6300 Series Multiple Angle Cabinet Unit Heater

Control Option (Step 8 on Model Designator)

SUFFIX	DESCRIPTION	LIST
B3	In-Built 1-Stage Stat and Relays which are operated by an internal 24 Volt source.	79
B4*	In-Built 1-Stage Stat and Relays which are operated by an internal 120 Volt source.	323
B5	In-Built 2-Stage Stat & Relays which are operated by an internal 24 Volt source.	79
B6*	In-Built 2-Stage Stat and Relays which are operated by an internal 120 Volt source.	323

*Motor fusing included for units with 120V internal or external control source.

Disconnect Option "C" Circuit Breaker (Step 10 on Model Designator)

KW	SINGLE PHASE				THREE PHASE			
	208V	240V	277V	600V	208V	340V	480V	600V
2	252	252	319	936	425	417	867	936
3	252	252	319	936	425	417	867	936
4	252	252	319	936	425	417	867	936
5	252	252	319	936	425	417	867	936
6	252	252	319	936	425	417	867	936
8	252	252	319	936	425	417	867	936
10	501	501	319	936	501	501	867	936
12	501	501	319	936	501	501	867	936
15	501	501	501	936	841	602	867	936
16	501	501	501	936	841	602	867	936
18	501	501	501	936	841	602	867	936
20	N/A	501	501	936	841	777	867	936
24	N/A	N/A	501	936	841	777	867	936

Circuit breakers shown in shaded areas are required by NEC because unit exceeds 48 Amps, all others listed are optional unless otherwise stated.

Disconnect Option "D" Disconnect Switch (Step 10 on Model Designator)

KW	SINGLE PHASE				THREE PHASE			
	208V	240V	277V	600V	208V	340V	480V	600V
2	195	195	195	250	250	250	240	250
3	195	195	195	250	250	250	240	250
4	195	195	195	250	250	250	240	250
5	195	195	195	250	250	250	240	250
6	240	195	195	250	250	250	240	250
8	270	240	240	250	250	250	240	250
10	N/A	313	240	250	282	250	240	250
12	N/A	N/A	313	250	282	285	240	250
15	N/A	N/A	N/A	250	N/A	285	240	250
16	N/A	N/A	N/A	250	N/A	391	240	250
18	N/A	N/A	N/A	250	N/A	391	240	250
20	N/A	N/A	N/A	250	N/A	N/A	313	250
24	N/A	N/A	N/A	250	N/A	N/A	313	250

Disconnect option is not available on heaters with circuit breakers.

Fan Switch & Motor Fusing (Step 11 on Model Designator)

SUFFIX	DESCRIPTION	ADDER
S	Summer Fan Switch	48
M	Motor Fusing (when not provided by control option)	89

Filter Option (Step 12 on Model Designator)

SUFFIX	SIZE	Qty. REQ'D	FILTER TYPE	LIST
F	33"	1	Replaceable	22
	46"	1		26
	66"	2		46
	79"	2		52
W	33"	1	Washable	59
	46"	1		60
	66"	2		395
	79"	2		629

8500 Series Commercial Slope Top Wall Convector

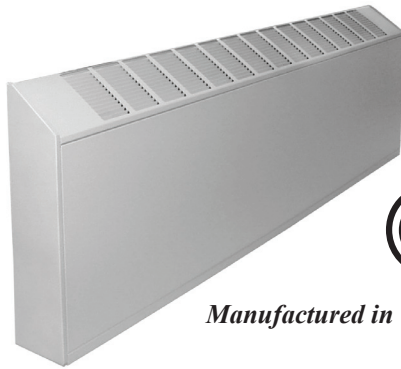

Manufactured in U.S.A.

- Front In/Top Out or Bottom In/Top Out air pattern.
- 16 gauge steel housing powder coated with beige finish.
- Tubular pre-wired wireway with 40 Amp capacity.
- Connection boxes for right or left hand wiring with combination 1/2" - 3/4" knockouts at back and bottom.
- Stainless steel element with Aluminum fins.
- Linear limit type thermal overload with automatic reset.
- Limited by max amp draw of 25 Amps (with no controls).

HOW TO DESIGNATE A MODEL:

85	2	5	125	H	B	DST1
Series Number	Cabinet Size 3=20"H x 5"D 2=14"H x 5"D 1=10"H x 3"D	Unit Length (feet) 2, 3, 4, 5, 6, 7, 8, 9, 0 (enter 0 for 10')	Watts per Foot Selectable in 1 watt increments up to max per model series 8510=250 max 8520=500 max 8530=750 max	Voltage E=120V F=208V G=277V H=240V	Air Flow B=Bottom in F=Front in	Factory Installed Options blank=none T1 or T2=Thermostat R1, R2, or R9=Relay DS=Disconnect (see control option chart)
Step 1	Step 2	Step 3	Step 4	Step 5	Step 6	Step 7

- Pencil proof louver design.
 - Custom colors available, consult factory.
- Note: Not for residential applications.
Note: Disconnect limits amperage to 20 Amps.

Standard Models

HEATER LENGTH	WATTS per FOOT	8510 SERIES		8520 SERIES		8530 SERIES	
		3" Depth x 10" Height Max watts per foot = 250		5" Depth x 14" Height Max watts per foot = 500		5" Depth x 20" Height Max watts per foot = 750	
		MODEL	LIST	MODEL	LIST	MODEL	LIST
2'	100-250	8512	516	8522	565	8532	688
	333-750		N/A		626		756
3'	100-250	8513	592	8523	652	8533	787
	333-750		N/A		717		866
4'	100-250	8514	683	8524	753	8534	907
	333-750		N/A		819		1001
5'	100-250	8515	753	8525	827	8535	1001
	333-750		N/A		908		1100
6'	100-250	8516	825	8526	906	8536	1100
	333-750		N/A		999		1208
7'	100-250	8517	906	8527	998	8537	1208
	333-750		N/A		1098		1330
8'	100-250	8518	998	8528	1098	8538	1330
	333-750		N/A		1208		1463
9'	100-250	8519	1098	8529	1208	8539	1463
	333-750		N/A		1329		1605
10'	100-250	8510	1208	8520	1329	8530	1605
	333-750		N/A		1460		1765

Note: All models qualify for international use

Note: Products listed in this section are custom built and subject to 100% cancellation/restocking charges.

CABINET:

Rugged 16 gauge front cover with discharge louvers in sloped top design. Pencil proof louver design for sloped outlet and front inlet grill. The finish shall be durable powder coated paint. Air flow available as bottom in - top out, or front in - top out.

ELEMENT:

All steel high mass element construction with Nickel-Chromium resistance wire embedded in compacted efficient dielectric to ensure proper heat transfer. Aluminum fins mechanically bonded to steel tube allows for increased surface area and even heat transfer.

LIMIT CONTROLS:

Automatic reset hydraulic thermal overload covers full length of heating element and shuts down heater when safe operating temperatures are exceeded.

WIRING:

Connection boxes in either end with 1/2 inch to 3/4 inch knockouts at back and bottom. Tubular prewired wire way with 40 Amp capacity.

CONTROLS:

Optional built in tamper resistant thermostat and disconnect is adjustable through top outlet louver.

MOUNTING:

Heater shall be surface mounted to wall or mullion. Bottom inlet units must be mounted a minimum of 4 inches above finished floor front inlet.

Voltage & Wattage Specification

Voltage	Standard Wattages Per Foot	Heater Lengths
120-277	100,125,150,165,187,200,250	2' through 10'

In-Built Control Options

SUFFIX	DESCRIPTION	LIST
T1	In-Built Tamper Proof, Single Pole, Bimetal Thermostat - 0°-110°F temp. range, 25 Amp	102
T2	In-Built Tamper Proof, Double Pole, Bimetal Thermostat - 0°-110°F temp. range, 25 Amp	132
DS	Double Pole Disconnect Switch, 20 Amp	150

Note: Due to size limitations, 8510 series convectors can only have thermostats as In-Built control options.

SUFFIX	DESCRIPTION	LIST
R1	DPST Relay, 30 Amps, up to 277V, 120V coil	145
R2	SPST Relay, 18 Amps @ 277V (max), 24V coil	145
R9	24V Transformer and SPST Relay, 22 Amps @240V, 18 Amps @ 277V (max), 24V coil (cannot be used in conjunction with T2 option)	159

Mounting/Air Flow Options

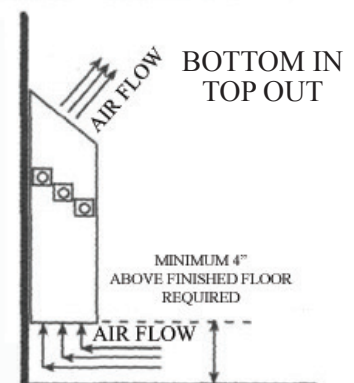
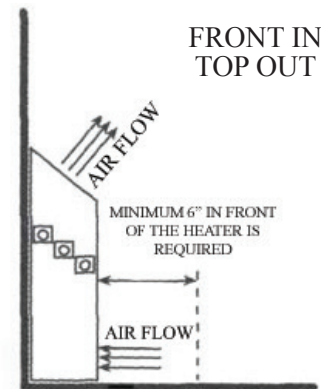

8800 Series Institutional Wall Convactor

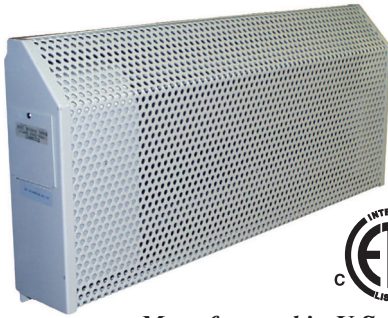

Manufactured in U.S.A.

- Single phase heaters available in all common voltages from 120V to 600V.
 - 11 gauge perforated steel housing powder coated with textured ivory finish.
 - Tamper proof left side control panel houses built-in single pole thermostat - range 40°F-110°F and disconnect switch. Thermostat on 120V-277V units is line voltage and low voltage (24V) on 346V-600V units.
 - Linear limit type thermal overload with automatic reset.
 - Tamper proof fasteners
 - Stainless steel element with Aluminum fins.
- Note: Not for residential applications.

Standard Models

UPC#	MODEL	WATTS	BTU'S	VOLTS	AMPS	LENGTH (IN.)	LIST
686334							
899000	E8801050	500	1706	120	4.167	18	2333
899062	F8801050			208	2.404		
899123	H8801050			240	2.083		
899185	G8801050			277	1.805		
899246	L8801050			346	1.445		
899307	P8801050			480	1.042		
899369	U8801050			600	0.833		
899017	E8802075			750	2560		
899079	F8802075	208	3.606				
899130	H8802075	240	3.125				
899192	G8802075	277	2.708				
899253	L8802075	346	2.168				
899314	P8802075	480	1.563				
899376	U8802075	600	1.25				
899024	E8803100	1000	3413			120	8.333
899086	F8803100			208	4.808		
899147	H8803100			240	4.167		
899208	G8803100			277	3.610		
899260	L8803100			346	2.890		
899321	P8803100			480	2.083		
899383	U8803100			600	1.667		
899031	E8804125			1250	4266	120	10.417
899093	F8804125	208	6.010				
899154	H8804125	240	5.208				
899215	G8804125	277	4.513				
899277	L8804125	346	3.613				
899338	P8804125	480	2.604				
899390	U8804125	600	2.083				
899048	E8805150	1500	5120			120	12.5
899109	F8805150			208	7.212		
899161	H8805150			240	6.25		
899222	G8805150			277	5.415		
899284	L8805150			346	4.335		
899345	P8805150			480	3.125		
899406	U8805150			600	2.5		
899055	E8806200			2000	6826	120	16.667
899116	F8806200	208	9.615				
899178	H8806200	240	8.333				
899239	G8806200	277	7.220				
899291	L8806200	346	5.780				
899352	P8806200	480	4.167				
899413	U8806200	600	3.333				

International Models

UPC#	MODEL	WATTS	BTU'S	VOLTS	AMPS	LENGTH (IN.)	LIST
686334							
984140	M8801050i	500	1706	220	2.3	18	2333
984157	H8801050i			240	2.1		
984164	M8802075i	750	2560	220	3.4	28	2657
984171	H8802075i			240	3.1		
984188	M8803100i	1000	3413	220	4.5	36	2970
984195	H8803100i			240	4.2		
984201	M8804125i	1250	4266	220	5.7	48	3337
984218	H8804125i			240	5.2		
984225	M8805150i	1500	5120	220	6.8	60	3618
984232	H8805150i			240	6.3		
984249	M8806200i	2000	6826	220	9.1	72	4017
984250	H8806200i			240	8.3		

CABINET:

Institutional enclosure 11 gauge perforated steel with sloped top design. Heavy duty end caps welded to the enclosure. Control compartment for housing thermostat and disconnect switch is accessible by use of security type fastener. The entire enclosure is protected by epoxy powder coated paint finish.

ELEMENT:

All steel high mass element construction with Nickel-Chromium resistance wire embedded in compacted efficient dielectric to ensure proper heat transfer. Aluminum fins mechanically bonded to steel tube allows for increased surface area and even heat transfer.

LIMIT CONTROLS:

Automatic reset hydraulic thermal overload covers full length of heating element and shuts down heater when safe operating temperatures are exceeded.

WIRING:

Wiring connections shall be made in left end of cabinet enclosure. Wiring must enter into control enclosure behind perforated steel grill.

CONTROLS:

All controls are accessible only through control enclosure door. Security type fasteners restrict access to controls. Built in thermostat and disconnect switch with manual adjustment are located in control enclosure.

HOW TO DESIGNATE A MODEL:

H	880	3	100
Element Voltage E=120 F=208 G=277 H=240 L=346 P=480 U=600	Series Number	Unit Length 1=18" 2=28" 3=36" 4=48" 5=60" 6=72"	Unit Wattage 050=500 075=750 100=1000 125=1250 150=1500 200=2000

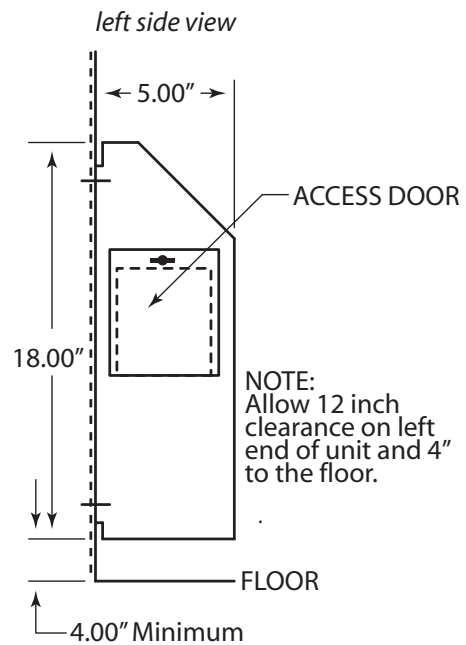

Optional In-Built Controls

SUFFIX	DESCRIPTION	LIST
T2	Tamperproof, Hydraulic, Double pole In-Built thermostat range 40°-110°F, 25 Amp	134
24V*	24 Volt In-Built single pole thermostat for 120V 208V, 240V & 277V models.	162

*Not available on international models

4100 Series Recessed Commercial Wall Convectors

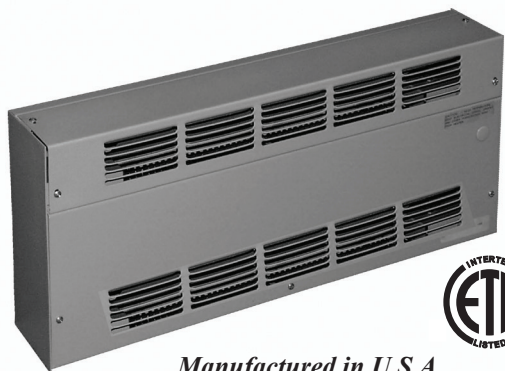

Manufactured in U.S.A.

- Front In / Front Out air pattern
- 16 gauge steel housing powder coated with textured beige finish.
- Tubular pre-wired wireway with 40 Amp capacity.
- Connection boxes for right or left hand wiring with combination 1/2"-3/4" knockouts at back and bottom.
- Steel heating element with steel fins.
- Linear limit thermal overload with automatic reset.

HOW TO DESIGNATE A MODEL:

M41	25	F	48	1000	T
<u>Series Number</u>	<u>Cabinet Size</u> 45=20"H x 5"D 25=11"H x 4"D	<u>Voltage/Phase</u> G=277V, 1 Phase J=208V, 3 Phase H=240V, 1 Phase K=240V, 3 Phase	<u>Unit Length (Inches)</u> 24, 36, 48, 60, or 72	<u>Total Wattage</u>	<u>Control Option</u> Blank=None R, R2, or R9=Relay T or T2=Thermostat (See control option chart)

- Recess trim frame included.
 - Custom colors available, consult factory.
- Note: Not for residential applications.

M4125 Dimensions - Cabinet Sizes 4" Deep x 11" High

LENGTH (Inches)	WEIGHT (Lbs.)	WATTS per FOOT AVAILABLE	VOLTS AVAILABLE	PH	LIST
24	20	187 250 333	208 240 277	1	708
36	33				818
48	39				949
60	49				1077
72	56				1198

M4145 Dimensions - Cabinet Sizes 5" Deep x 20" High

LENGTH (Inches)	WEIGHT (Lbs.)	WATTS per FOOT AVAILABLE	VOLTS AVAILABLE	PH	LIST
24	45	187 250 333	208 240 277	1	763
36	53				929
48	63				1126
60	77				1368
72	92				1646
24	47	500 666	208 240 277	1	775
36	57				997
48	67				1217
60	82				1473
72	100				1791

Note: Products listed in this section are custom built and subject to 100% cancellation/restocking charges.

Note: Please see page 60 for custom color availability - add 10% to net heater cost.

CABINET:

4100 series casing shall be of square design with front inlet and outlet grills suitable for recess installation. The cabinet is fabricated from 16 gauge cold rolled steel and finished with powder coated baked enamel. Junction boxes are available for left or right wiring and connected by pre-wired 40 Amp capacity wireway.

ELEMENT:

All steel high mass element construction with Nickel-Chromium resistance wire embedded in compacted efficient dielectric to ensure proper heat transfer. Aluminum fins mechanically bonded to steel tube allows for increased surface area and even heat transfer.

LIMIT CONTROLS:

Automatic reset hydraulic thermal overload covers full length of heating element and shuts down heater when safe operating temperatures are exceeded.

WIRING:

Wiring connections shall be made in left end of cabinet enclosure. Wiring must enter into control enclosure behind perforated steel grill.

CONTROLS:

All controls are accessible only through control enclosure door. Security type fasteners restrict access to controls. Built in thermostat with manual adjustment are located in control enclosure.

In-Built Control Options for Single Phase Units

SUFFIX	DESCRIPTION	LIST
T	In-Built Tamper Proof, Single Pole, Hydraulic Thermostat - 40°-110°F temp. range, 25 Amps	106
T2	In-Built Tamper Proof, Double Pole, Hydraulic Thermostat - 40°-110°F temp. range, 25 Amps	131
R	DPST Relay, 30 Amps, up to 277V, 120V coil	139
R2	SPST Relay, 18 Amps @ 277V (max), 24V coil	147
R9	24V Transformer and SPST Relay, 22 Amps @24V, 18 Amps @ 277V (max), 24V coil	175

Note: No In-Built control options for 3 phase models.

12" Control Section

UNIT LENGTH	MODEL 4125	LIST	MODEL 4145	LIST
12"	MSE4120-12	81	MSE4140-12	131

Note: Control section required when relay is ordered.

Solid Back Panel

UNIT LENGTH	MODEL 4125	LIST	MODEL 4145	LIST
24"	MS4122	66	MS4142	106
36"	MS4123	86	MS4143	117
48"	MS4124	112	MS4144	179
60"	MS4125	136	MS4145	223
72"	MS4126	159	MS4146	259

3000 Series Fan Forced Ceiling Heater



Manufactured in U.S.A.



Standard Models

WHITE		SELECTABLE INSTALLATION WATTAGE	MAX BTU'S	VOLTS	MAX AMPS	LIST
UPC#	MODEL					
686334						254
948821	E3035DWBW	750 or 1500	5120	120	13	
948838	E3038DWBW	900 or 1800	6143	120	15	
948883	H3032DWBW	750 or 1000 - 1500 or 2000	6826	208 / 240	8	
948906	G3032DWBW	2000	6826	277	7	

Selectable Wattages, Back Cans, And Power Disconnects

- Wattage selectable at time of installation - models shipped wired to highest Wattage
- Fan purge circuit (has 2 wire control circuit for use with remote wall thermostat)
- Models may not be used with remote double pole thermostat
- Drywall depth embossments on back can
- Powder coated 18 gauge steel front
- Manual reset thermal limit
- Steel block fin element
- Propeller style fan blade - 1060 RPM / 100 CFM
- Weight 6 lbs.
- Optional field installed control voltage relays available
- Rough in dimensions - 9 1/4" Wide - 12 1/8" High - 3 5/8" Deep
- Grill dimensions: 9 25/32" Wide - 13" High

Field Installed Accessories

UPC#	MODEL	DESCRIPTION	LIST
686334			
996846	30R	24 VOLT RELAY	35
996853	30R2	120 VOLT RELAY	
951500	30R8	208/240 VOLT RELAY	37
951494	30R7	277 VOLT RELAY	
996976	303EX8RW	1" EXTENDER	39
996969	303EX16RW	2" EXTENDER	40
996952	303EX32RW	4" SURFACE MOUNT FRAME	46
460033	TB3000	T-BAR FRAME	58

3380 Series Commercial Fan Forced Ceiling Heater

Product Specifications

The heaters are be constructed of a heavy gauge steel housing. The rough-in dimensions are 19-3/16" wide x 4" deep. The finish shall be baked-on powder coat in Ceiling White color. The units shall be available in ratings from 1500 through 4800 Watts with an optional factory installed single pole thermostat.

The heaters have a low speed 600-RPM motor, which drives a vane axial blower to deliver a quite 175 CFM's of down flow air. The heating element shall be of the block finned type with large, parallel steel fins for quick heat transfer. Unit shall have as standard, a manual reset capillary type limit control, for added safety. Unit weight 22 pounds.



Manufactured in U.S.A.

Features & Standard Models

Recess, Surface, Or "T" Bar Mounting



- Fan purge circuit (has 2 wire control circuit for use with remote wall thermostat)
- Disconnect switch
- White powder coated 18 gauge steel grill
- Manual reset thermal limit
- Steel block fin element
- Vane axial fan blade:
1.5KW - 4.0KW units: 700 RPM motor; 175 CFM
4.8KW units: 900 RPM motor; 200 CFM
- Rough in dimensions:
14 3/16" wide x 19 5/16" high x 4" deep
- Grill dimensions:
15 3/8" wide x 20 9/64" high
- Optional factory installed tamper resistant thermostat

UPC#	MODEL	KW	BTU'S	VOLTS	PH	AMPS	TEMP RISE	LIST	
366489	E3383D-RP	1.5	5120	120	1	12.5	27 °F	589	
366298	F3386D-RP	4.0	13600	208		19.2	72 °F	619	
366304	F3387D-RP	4.8	16382	208		23.1	76 °F	697	
366342	HF3384D-RP	2.0 / 1.5	6826/5120	240/208		8.3/7.2	36 °F	541	
366359	HF3385D-RP	3.0 / 2.3	10200/7679	240/208		12.5/10.8	54 °F	617	
366366	HF3386D-RP	4.0 / 3.0	13600/10200	240/208		16.8/14.4	72 °F		
366373	H3387D-RP	4.8	16382	240		20	76 °F	696	
366502	G3383D-RP	1.5	5120	277		5.4	27 °F	589	
366410	G3384D-RP	2.0	6826	277		7.2	36 °F	617	
366427	G3385D-RP	3.0	10200	277		10.8	54 °F	697	
366434	G3386D-RP	4.0	13600	277		14.4	72 °F		
366441	G3387D-RP	4.8	16382	277		17.3	76 °F	772	
International Models									
470889	M3384D-RPi	1680	5734	220		1	7.6	30 °F	589
470896	M3385D-RPi	2520	8600		11.5		50 °F	619	
470902	M3386D-RPi	4032	13761		18.3		72 °F	697	

Accessories

UPC	MODEL	DESCRIPTION	WT.	LIST
686334				
377850	BOX3310	Additional Back Can	10 lbs	96
381109	3380EX33	Surface Mounting Adapter	1 lb	85
460026	TB3380	2X2 T-Bar Mounting Kit	7 lbs	57
Thermostat- Add suffix T to model		Factory installed single pole, positive off. Range-60° F-105° F		111

3480 Series Commercial Fan Forced Recessed Mounted Ceiling Heater

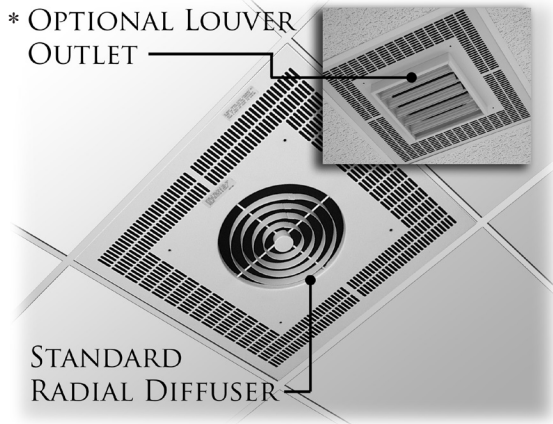

Manufactured in U.S.A.

Notes

Optional controls must be factory installed. Field installation is not acceptable and violates Listing and factory warranty.

Wall mounted control panels may control multiple units but cannot be used if in-built controls are selected.

480V units include 24V transformer and relay as standard (A1) - only TS option control section can be added. Depth dimension of all 480V models is 10-7/8"

Degree F air rise is measured at 710 F.P.M. and 425 CFM. Throw designed for 8 to 12 foot ceilings. db RE 10⁻¹² Watt=63.9

Unit Weight: 50 lbs.

Recommended Remote Thermostats:
 Line Voltage: Single Phase 208-240V ET5DS
 Single Phase 277V ET5SS
 Three Phase TW1512

Low Voltage: UT1001

Product Specifications

Contractor shall supply and install heavy duty ceiling mounted forced air electric heater(s) of the wattage, voltage and phase as indicated on the plans. The heater shall be so designed to provide an even distribution of heated air to the space to be heated by drawing return air in the periphery of the heater, across and through the element and be discharged from the center section of the heater by means of an electric motor and axial flow fan blade.

Heaters shall be recessed type and mounted flush with the finished ceiling. The return grille assembly shall be constructed of a one piece heavy gauge steel with 1/4" slots for return air and concentric rings for uniform air discharge. Grille assembly shall be attached to chassis by tamper-resistant (allen head) machine screws. All parts of enclosure shall be heavy gauge steel, zinc coated both sides and finished in neutral off white powder coat paint.

Enclosure shall be constructed of 1/6" x 3/8" rounded edge horizontal steel louvers which shall be spaced for maximum opening of 5/16". Louvers shall be welded at every intersection to evenly spaced 1/8" diameter vertical members. Discharge grille to have concentric rings for uniform air discharge. Grille assembly shall be attached to chassis by tamper-resistant (allen head) machine screws. All part of enclosure shall be heavy gauge steel, Zinc coated both sides and finished in no more than 60 Watts per inch.

Motor shall be permanent lubricated, unit bearing, totally enclosed, impedance protection. Motors shall operate at no more than 1300 RPM and shall be same voltage as the heater.

Heaters shall have a rating of 425 CFM at 710 F.P.M. with a maximum temperature rise of 44°F and 63.9 DB RE 10¹² Watt.

Element assemblies shall consist of two or three corrosion resistant steel sheathed type elements mechanically bonded to common corrosion resistant steel fins. Each sheathed element shall consist of helically coiled Nickel Chromium alloy resistant wire completely embedded in and surrounded by magnesium oxide, enclosed and wedged into corrosion resistant steel sheaths. Elements shall have 2" cold conductor pins extending into sheath and shall have a density of no more than 60 Watts per inch.

Heaters shall be equipped with a "manual reset" thermal overload which disconnects elements and motor in the event normal operating temperatures are exceeded. For safety, if opened due to abnormal temperature, thermal overload shall remain open until manually reset. Automatic reset thermal overloads which allow the element to continue to cycle under abnormal conditions will not be accepted. Heaters shall be ETL listed.

Features

- White powder coated 20 gauge grill.
- 208V, 240V, & 277V units have manual reset thermal limit.
- 480V units have manual reset thermal limit, 24V control transformer, and 24V relay (A1 suffix).
- Enclosed steel fin sheath element.
- Rough in dimensions: 23-1/16" sq. x 9-1/8" deep.



Standard Models

UPC#	MODEL	KW	BTU'S	VOLTS	PH	AMPS	TEMP RISE	LIST
686344								
367653	F3482	2	6826	208	1	9.6	15 °F	1334
367677	H3482			240		8.3		
367660	G3482			277		7.2		
318471	P3482A1	2	6826	480	3	4.2	15 °F	1460
470186	J3482			208		5.6		
470209	K3482			240		4.8		
470247	Y3482A1	2	6826	480	1	2.4	22 °F	1557
367684	F3483			208		14.4		
367707	H3483			240		12.5		
367691	G3483	3	10200	277	3	10.8	22 °F	1476
318488	P3483A1			480		6.3		
470193	J3483			208		8.3		
470216	K3483	3	10200	240	1	7.2	22 °F	1448
470254	Y3483A1			480		3.6		
367714	F3484			208		19.2		
367738	H3484	4	13600	240	1	16.8	30 °F	1366
367721	G3484			277		14.4		
318501	P3484A1			480		8.3		
367745	J3484	4	13600	208	3	11.1	30 °F	1475
367752	K3484			240		9.7		
318587	Y3484A1			480		4.8		
367769	F3485	5	17000	208	1	24.1	37 °F	1532
367783	H3485			240		20.8		
367776	G3485			277		18.1		
318549	P3485A1	5	17000	480	3	10.4	37 °F	1665
367790	J3485			208		13.9		
367806	K3485			240		12.1		
318402	Y3485A1	5	17000	480	1	6.1	37 °F	1755
366106	PT3480			240		16.7		
Recess Frame - Weight 5 lbs.								
International Models								
470971	M3482T2i	2	6826	220	1	9.1	15 °F	1334
470988	N3482T2i			240		8.3		
470995	M3483T2i	3	10200	220	1	13.6	22 °F	1350
471008	N3483T2i			240		12.5		
471015	M3484T2i	4	13600	220	1	18.2	30 °F	1366
471022	N3484T2i			240		16.7		

*Optional Louver Outlet - \$70 Adder

Factory Installed Control Sections

SUFFIX	DESCRIPTION	LIST
A1	Transformer with 24V Secondary and 24V Relay	127
S	Disconnect Switch	158
TA1S	Thermostat / Transformer / Disconnect Switch	371
TA1	Single Pole Thermostat and Transformer with 24V Secondary and 24V Relay	231
A1S	Transformer with 24V Secondary and 24V Relay and Disconnect Switch	287
T2	Double Pole Thermostat	126
T2S	Double Pole Thermostat and Disconnect Switch	281
R	Relay Control Voltage Same as Heater (control voltage field supplied)	78
R1	Relay 24V Control Voltage (control voltage field supplied)	127
R2	Relay 120V Control Voltage (control voltage field supplied)	117
T	Single Pole (480V only)	95
L	Factory installed adjustable louver diffuser option.	91

Product Dimensions

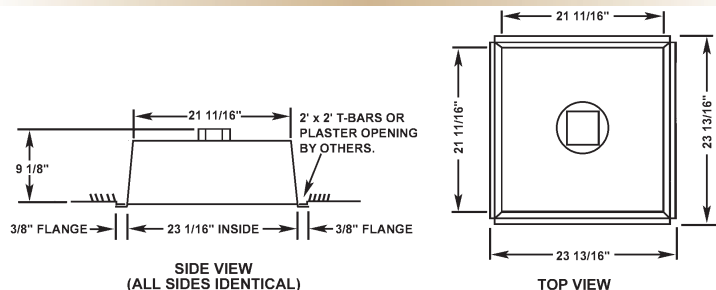

3470 Series Commercial Fan Forced Surface Mounted Ceiling Heater

Product Specifications

Contractor shall supply and install heavy duty ceiling mounted forced air electric heater(s) of the wattage, voltage and phase as indicated on the plans. The heater shall so be designed to provide an even distribution of heated air to the space to be heated by drawing return air in the periphery of the heater, across and through the element and be discharged from the center section of the heater by mean of an electric motor and axial flow fan blade.

Motor: Motor shall be permanent lubricated, unit bearing, totally enclosed shaded pole type with impedance protection. Motors shall operate at no more than 1300 RPM and shall be same voltage as the heater.

Performance: Heaters shall have a rating of 425 CFM at 710 F.P.M. with a maximum temperature rise of 44°F and 63.9 DB RE 1012 Watt.

Element: Element assemblies shall consist of two or three corrosion resistant steel sheathed type elements mechanically bonded to common corrosion resistant steel fins. Each sheathed element shall consist of helically coiled Nickel Chromium alloy resistant wire completely embedded in and surrounded by Magnesium Oxide, enclosed and wedged into corrosion resistant steel sheaths. Elements shall have 2" cold conductor pins extending into sheath and shall have a density of no more than 60 watts per inch.

Thermal Overload: Heaters shall be equipped with a "manual reset" thermal overload which disconnects elements and motor in the event normal operating temperatures are exceeded. For safety, if opened due to abnormal temperature, thermal overload shall remain open until manually reset. Automatic reset thermal overloads which allow the element to continue to cycle under abnormal conditions will not be accepted.

Approval: Heaters shall be ETL listed.

Commercial and Institutional Applications: Use in - vestibules, entrance ways, lobbies, rest rooms and small office and guard building applications.



Manufactured in U.S.A.

Product Dimensions

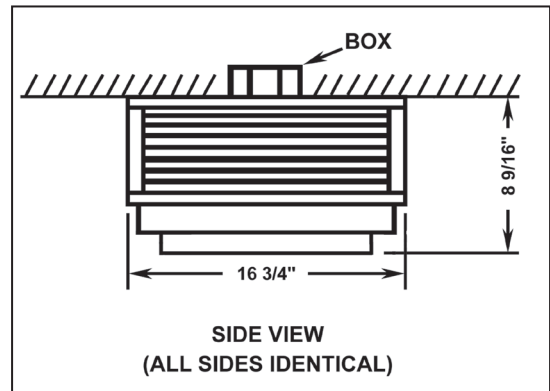

Standard Models

UPC#	MODEL	KW	BTU'S	VOLTS	PH	AMPS	TEMP RISE	LIST
686334								
367516	F3472	2	6826	208	1	9.6	15 °F	1334
367530	H3472			240		8.3		
367523	G3472			277		7.2		
324335	P3472A1	2	6826	480	3	4.2	15 °F	1460
470155	J3472			208		5.6		
470162	K3472			240		4.8		
470223	Y3472A1	2	6826	480	3	2.4	15 °F	1557
367547	F3473			208		14.4		
367561	H3473			240		12.5		
367554	G3473	3	10200	277	1	10.8	22 °F	1350
324342	P3473A1			480		6.3		
323864	J3473			208		8.3		
470179	K3473	3	10200	240	3	7.2	22 °F	1463
470230	Y3473A1			480		3.6		
367578	F3474			208		19.2		
367592	H3474	4	13600	240	1	16.8	30 °F	1366
367585	G3474			277		14.4		
324359	P3474A1			480		8.3		
367608	J3474	4	13600	208	3	11.1	30 °F	1475
367837	K3474			240		9.7		
324366	Y3474A1			480		4.8		
367615	F3475	5	17000	208	1	24.1	37 °F	1532
367639	H3475			240		20.8		
367622	G3475			277		18.1		
324373	P3475A1	5	17000	480	3	10.4	37 °F	1665
367646	J3475			208		13.9		
367844	K3475			240		12.1		
324380	Y3475A1	5	17000	480	3	6.1	37 °F	1755

International Models

470919	M3472T2i	2	6826	220	1	9.1	15 °F	1334
470926	N3472T2i			240		8.3		
470933	M3473T2i	3	10200	220	1	13.6	22 °F	1366
470940	N3473T2i			240		12.5		
470957	M3474T2i	4	13600	220	3	18.2	30 °F	1366
470964	N3474T2i			240		16.7		

*Optional Adjustable Louver Diffuser - \$91 Adder

Factory Installed Control Sections

SUFFIX	UNITS	DESCRIPTION	LIST
TS	1-Phase	Single Pole Thermostat - range 40°-110°F and Disconnect Switch	265
TA1S	3-Phase	Single Pole Thermostat - range 40°-110°F & Transformer with 24V Secondary and 24V Relay & Disconnect Switch	277
A1S	1 or 3 Phase	Transformer with 24V Secondary and 24V Relay and Disconnect Switch	283
T		Single Pole (480V only)	95

Wall Mounted Control Panels

UPC#	MODEL	VOLTS	CONTACTORS	BOX SIZE	LIST
605700	AF3401-24	208	1 @ 35 AMPS	12" x 12" x 4 1/2"	360
605793	AH3401-24	240			
605854	AG3401-24	277	2 @ 35 AMPS	15" x 15" x 4 1/2"	450
605748	AF3402-24	208			
605786	AH3402-24	240			
605847	AG3402-24	277	3 @ 35 AMPS	18" x 18" x 4 1/2"	600
605731	AF3403-24	208			
605779	AH3403-24	240			
605830	AG3403-24	277			

Notes

Optional controls must be factory installed. Field installation is not acceptable and violates Listing and factory warranty.

Factory installed control sections add 2-5/16" to the height of the unit.

Wall mounted control panels may control multiple units but cannot be used if In-Built controls are selected.

480V units include 24V transformer and relay as standard (A1) - only TS option control section can be added. Depth dimension of all 480V models is 10-7/8"

Degree F air rise is measured at 710 F.P.M. and 425 CFM. Throw designed for 8 to 12 foot ceilings. db RE 10⁻¹² Watt=63.9

Unit weight: 32 lbs.

Recommended Remote Thermostats:
Line Voltage: Single Phase 208-240V
Single Phase 277V
Three Phase

ET5DS
ET5SS
TW1512

Low Voltage:

UT1001

CP & RCP Series Radiant Ceiling Panel Heaters

Product Description

For Surface Or Recessed Installation, Radiant Ceiling Panels radiate energy like the solar radiation which warms us, heats objects, not the air. With no moving parts, these heating panels create gentle warmth and toasty comfort.



Manufactured in U.S.A.

Radiant Ceiling Panels provide a low surface temperature and broad heat distribution. Clean, gentle comfortable heat that is ideal for offsetting perimeter heat loss or neutralizing downdrafts over glass. These versatile and flexible panels may be used virtually anywhere in homes, schools, hospitals, motels and a broad variety of other commercial or industrial installations.

Product Specifications

Construction:

Radiant Ceiling Panels shall be made of highest quality steel casing. Front panel shall be painted with textured powder coated finish. Electric Resistance element is fixed between dielectric material and insulation. Two inches of insulation is compressed to one inch by back panel to minimize upward heat loss and radiant efficiency. Radiant panels shall have 36" pre-wired flexible cable for easy installation and wiring connections.

Installation:

CP Series shall be designated as 2x2 or 2x4 size. All panels are 1" thick. The size shall be nominal dimension to be manufactured to fit drop ceiling systems. Standard units will fit regular "T" bar frame. For regular or trim line or other frame sizes, special construction is required. RCP Series shall be used in recess mounting applications. RCP Series shall be 2" less in width to recess between nominal 24" center ceiling joists. RCP Series shall be complete with recess frame for finished construction.

Accessories:

Surface mounting frames shall be optional for surface mounting the CP Series, and are Aluminum mill finish. Frames can be painted white to match panel.

Options:

Silk-screening the exposed surface to match ceiling tiles is available, as well as silicone sealed metal parts for high humidity applications.

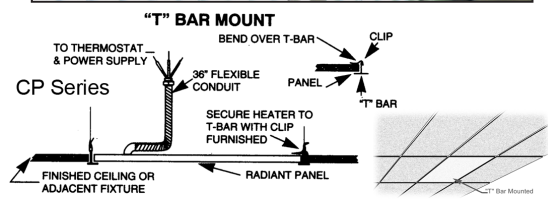

FOR SURFACE MOUNTED UNITS USE STANDARD "T" BAR CEILING PANEL AND SURFACE MOUNTING FRAME.

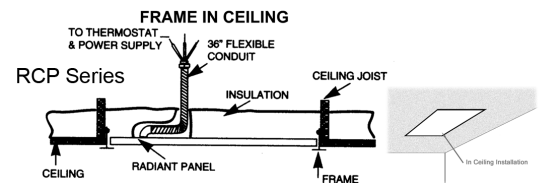
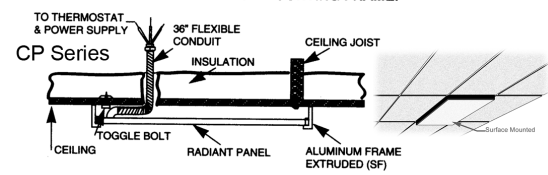

CP Series - "T" Bar & Surface Mounted

UPC#	MODEL	WATTS	BTU's	AMPS	VOLTS	WT	LIST
686334	Dimensions: 2' x 4' (Nominal) x 1"						
458719	CP805	500	1707	2	208	20 lb.	412
458726	CP125			4.2/2.1	120/240		
458733	CP705			2	277		
458740	CP807	750	2560	4	208	20 lb.	425
458757	CP127			6.3/3.1	120/240		
458764	CP707			3	277		
Dimensions: 2' x 2' (Nominal) x 1"							
458771	CP802	250	853	1	208	13 lb.	270
458788	CP122			2.1/1.0	120/240		
458795	CP702			.9	277		
458801	CP803	375	1280	2	208	13 lb.	327
458818	CP123			3.1/1.6	120/240		
458825	CP703			1	277		
459105	SF400 Surface Frame for 2' x 4' Panels (CP only)					10 lb.	182
459099	SF200 Surface Frame for 2' x 2' Panels					6 lb.	144

RCP Series - Frame in Ceiling Mounted

UPC#	MODEL	WATTS	BTU's	AMPS	VOLTS	WT	LIST
686334	Dimensions: 2' x 4' (Including Recessing Frame)						
458832	RCP805	500	1707	2	208	30 lb.	585
458849	RCP125			4.2/2.1	120/240		
458856	RCP705			2	277		
458863	RCP807	750	2560	4	208	30 lb.	646
458870	RCP127			6.3/3.1	120/240		
458887	RCP707			3	277		
Dimensions: 2' x 2' (Including Recessing Frame)							
458894	RCP802	250	853	1	208	19 lb.	393
458900	RCP122			2.1/1.0	120/240		
458917	RCP702			.9	277		
458924	RCP803	375	1280	2	208	19 lb.	493
458931	RCP123			3.1/1.6	120/240		
458948	RCP703			1	277		

International Models

UPC#	MODEL	WATTS	BTU's	AMPS	VOLTS	WT	LIST
686334	Dimensions: 2' x 4' (Nominal) x 1"						
471039	CP2205i	420	1434	1.9	220	20	412
471046	CP125i	500	1707	4.2/4.1	120/240		
471053	CP2207i	630	2150	2.9	220		
471060	CP127i	750	2560	6.3/3.1	120/240	20	425
Dimensions: 2' x 2' (Nominal) x 1"							
471077	CP2202i	210	717	0.95		13	270
471084	CP122i	250	853	2.1/1.0	120/240		
471091	CP2203i	315	1075	1.4	220	13	327
471107	CP123i	375	1280	3.1/1.6	120/240		

UPC#	MODEL	WATTS	BTU's	AMPS	VOLTS	WT	LIST
686334	Dimensions: 2' x 4' (Including Recessing Frame)						
471114	RCP2205i	420	1434	1.9	220	30	585
471121	RCP125i	500	1707	4.2/4.1	120/240		
471138	RCP2207i	630	2150	2.9	220		
471145	RCP127i	750	2560	6.3/3.1	120/240		
Dimensions: 2' x 2' (Including Recessing Frame)							
471152	RCP2202i	210	717	0.95	220	19	393
471169	RCP122i	250	853	2.1/1.0	120/240		
471176	RCP2203i	315	1075	1.4	220		
471183	RCP123i	375	1280	3.1/1.6	120/240		

CVX Series Radiant Cove Ceiling Heater

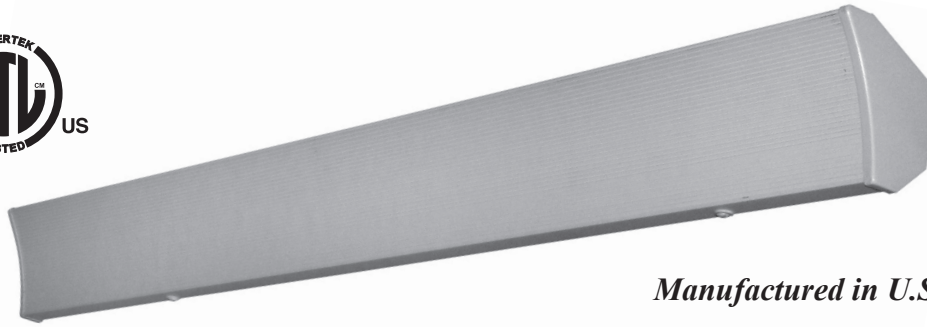

Manufactured in U.S.A.

Product Description

Cove Heaters have a subtly contoured concave surface with a saw-tooth profile. The concave parabolic face plate performs a two-fold function: (1) it focuses the infrared rays and (2) directs the heat downward along cold perimeters and toward the center of the room. The sawtooth surface design increases the radiating surface area by 45%, thereby increasing the comfort level of the room faster and insuring more rapid recovery from heat losses.

Product Specifications

Furnish and install Electric Cove Heaters where specified. The heaters shall be constructed of .962" thick Aluminum. The heater surface shall be concave in contour and saw-tooth in profile. The finish shall be of powder coat white finish. The heaters shall be available in ratings from 450 through 1250 Watts, at 120, 240, 208 and 277 Volts. The heating element shall be of Nichrome wire, embedded in Magnesium Oxide powder, enclosed and sealed in Aluminum metal tubing. The heater shall be listed by ETL and the elements shall be supplied with a one year limited warranty.

Standard Models

UPC#	MODEL	WATTS	BTU's	AMPS	VOLTS	LENGTH	WT.	LIST
686334								
457583	CV4512X	450	1536	4	120	42"	7 lb.	207
457590	CV45X	450		2	240			
457606	CV45YX	450		2.0	208			
457613	CV4527X	450		2	277			
457620	CV6012X	600	2048	5.0	120	60"	10 lb.	258
457637	CV60X	600		3	240			
457644	CV60YX	600		3	208			
457651	CV6027X	600		2	277			
457668	CV7512X	750	2560	6	120	72"	13 lb.	285
457675	CV75X	750		3	240			
457682	CV75YX	750		3.6	208			
457699	CV7527X	750		3	277			
457705	CV9012X	900	3072	8	120	84"	14 lb.	322
457712	CV90X	900		4	240			
457729	CV90YX	900		4	208			
457736	CV9027X	900		3	277			
457743	CV10012X	1000	3413	8	120	96"	17 lb.	335
457750	CV100X	1000		4	240			
457767	CV100YX	1000		5	208			
457774	CV10027X	1000		4	277			
457781	CV11012X	1100	3754	9	120	108"	19 lb.	373
457798	CV110X	1100		5	240			
457804	CV110YX	1100		5	208			
457811	CV11027X	1100		4.0	277			
457828	CV12512X	1250	4266	10	120	120"	21 lb.	412
457835	CV125X	1250		5	240			
457842	CV125YX	1250		6.0	208			
457859	CV12527X	1250		5	277			

International Models

471190	CV4522Xi	450	1536	2.0	220	42"	7	207
471206	CV45Xi			1.9	240			
471213	CV6022Xi	600	2048	2.7	220	60"	10	258
471220	CV60Xi			2.5	240			
471237	CV7522Xi	750	2560	3.4	220	72"	13	285
471244	CV75Xi			3.1	240			
471251	CV9022Xi	900	3072	4.1	220	84"	14	322
471268	CV90Xi			3.8	240			
471275	CV10022Xi	1000	3413	4.5	220	96"	17	335
471282	CV100Xi			4.2	240			
471299	CV11022Xi	1100	3754	5.0	220	108"	19	373
471305	CV110Xi			4.6	240			
471312	CV12522Xi	1250	4266	5.7	220	120"	21	412
471329	CV125Xi			5.2	240			

Accessories & Dimensions

UPC#	MODEL	DESCRIPTION	WT.	LIST
686334				
457927	CVCBX	Ceiling Bracket*	1/2 lb.	14
457866	CVB42X	42" Blank Section	6 lb.	48
457873	CVB60X	60" Blank Section	8 lb.	70
457880	CVB84X	84" Blank Section	12 lb.	94
457912	CVSP	Aerosol Touch-up Paint	1 lb.	44

* Order 2 for units up to 72"
Order 3 for units over 72"

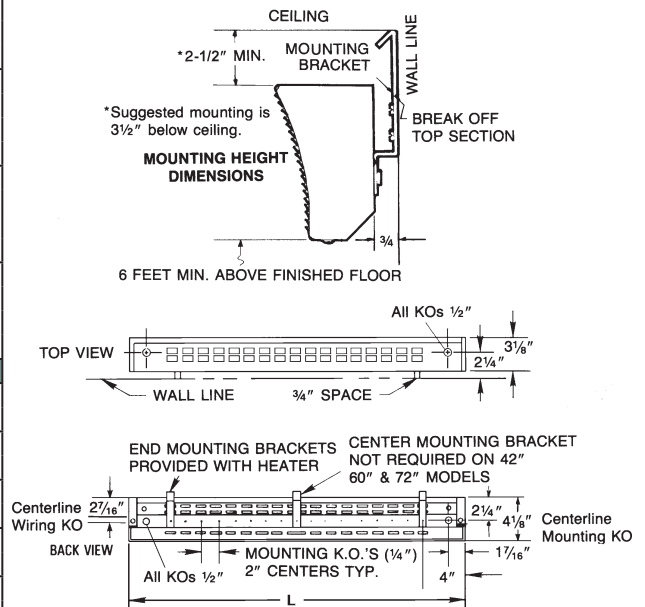



Approved for wall or ceiling installation

Manufactured in U.S.A.

Features

- Wattage selectable at time of installation.
- Models shipped wired to highest wattage.
- Approved for horizontal mounting - right or left discharge.
- Fan purge circuit.
- Disconnect switch.
- Drywall depth embossments on back can.
- 18 gauge powder coated steel & extruded Aluminum front.
- Manual reset thermal limit.
- Steel block fin element.
- Propeller style fan blade: 1060 RPM motor; 100 CFM.
- Weight 6 lbs.
- Rough in dimensions: 9-1/4" Wide x 12-1/8" High x 3-5/8" Deep.
- Grill dimensions: 10" Wide x 13-1/8" High.

Standard Models

UPC# 686334	MODEL	SELECTABLE INSTALLATION WATTAGE	MAX BTU's	VOLTS	MAX AMPS	LIST
TAMPERPROOF IN-BUILT DOUBLE POLE THERMOSTAT (50° - 90° TEMPERATURE RANGE)						
996211	E3055T2DWB	750 or 1500	5120	120	12.5	298
996228	E3058T2DWB	900 or 1800	6143	120	15.0	296
996259	F3052T2DWB	1000 or 2000	6826	208	8.3	
945691	F30522T2DWB	500 or 750 or 1000 or 1250 or 1500 or 1750 or 2250	7680	208	10.8	344
996280	H3052T2DWB	750 or 1000 - 1500 or 2000	6826	208 / 240	8.3	298
945721	H30522T2DWB	500 or 750 or 1000 or 1250 or 1500 or 1750 or 2250	7680	240	9.4	342
996310	G3052T2DWB	2000	6826	277	7.2	302
TAMPERPROOF IN-BUILT SINGLE POLE THERMOSTAT (50° - 90° TEMPERATURE RANGE)						
996068	E3055TDWB	750 or 1500	5120	120	12.5	280
996075	E3058TDWB	900 or 1800	6143	120	15.0	282
996105	F3052TDWB	1000 or 2000	6826	208	8.3	
945639	F30522TDWB	500 or 750 or 1000 or 1250 or 1500 or 1750 or 2250	7680	208	10.8	325
996136	H3052TDWB	750 or 1000 - 1500 or 2000	6826	208 / 240	8.3	280
945660	H30522TDWB	500 or 750 or 1000 or 1250 or 1500 or 1750 or 2250	7680	240	9.4	311
996167	G3052TDWB	2000	6826	277	7.2	282

Accessories

UPC# 686334	MODEL	DESCRIPTION	LIST
996945	305EX8	1" EXTENDER	39
996938	305EX16	2" EXTENDER	40
996921	305EX32	4" SURFACE MOUNT FRAME	45

Note: Please see page 60 for custom color availability - add 10% to net heater cost.

3320 Series Commercial Fan Forced Wall Heater



Manufactured in U.S.A.

Features

- Disconnect switch.
- Automatic fan delay circuit.
- Powder coated 18 gauge steel grill with extruded Aluminum front frame.
- Automatic reset thermal limit.
- Steel block fin element.
- Vane axial fan blade:
600 RPM motor; 175 CFM
- Rough-in dimensions:
14-3/16" Wide x 19-7/16" High x 4" Deep
- Grill dimensions:
15-29/32" Wide x 20-27/32" High
- Built-In tamper proof thermostat.



Product Specifications

Furnish and install Heavy-Duty Forced Air wall heaters, where specified. The heaters shall be constructed of a heavy 18 gauge steel housing with an extruded Aluminum frame. The rough-in dimensions are 19-7/16" High x 14-3/16" Wide x 4" Deep. The units shall be available in ratings from 750 to 4800 Watts at 240, 208, and 277 Volts. The heaters shall have a low-speed 600 RPM, 4-pole motor which drives a vane axial blower to deliver a quiet 175 CFM of down flow air. The heating element shall be

of the sealed tubular type with large, parallel steel fins for quick heat transfer. Unit shall have as a standard, a thermal overload cut-off for added safety, fan delay switch and built-in tamper proof thermostat which shall be calibrated to provide a range of 55°F. to 85°F. and manual disconnect switch.

Optional accessories shall include a surface and semi-recess mounting adapter. All heaters shall be listed by ETL. The heating element shall be supplied with a manufactures 1-year limited warranty.

Standard Models

UPC#	MODEL	WATTS	BTU's	VOLTS	AMPS	WT. LBS.	LIST
IN-BUILT SINGLE POLE TAMPERPROOF THERMOSTAT (50° - 90° TEMPERATURE RANGE)							
FOR DOUBLE POLE THERMOSTAT REPLACE "T" IN MODEL NUMBER WITH "T2" -- Add \$50							
382052	E3321TD-RP	750	2560	120	6.25	26	637
381994	E3322TD-RP	1000	3413		8.3		
380881	E3323TD-RP	1500	5120		12.5		
380935	F3326TD-RP	4000	13800	208	19.2	26	648
381024	F3327TD-RP	4800	16560		23		
380942	HF3323TD-RP	1500 / 1125	5120 / 3840	240 / 208	6.2 / 5.4	27	648
380959	HF3324TD-RP	2000 / 1500	6284 / 5120		8.3 / 7.2		
380966	HF3325TD-RP	3000 / 2250	10350 / 7763	208	12.5 / 10.8	29	648
380973	HF3326TD-RP	4000 / 3000	13800 / 10350		16.7 / 14.4		
381031	H3327TD-RP	4800	16560	240	20	29	674
380980	G3323TD-RP	1500	5120	277	4.1	26	647
380997	G3324TD-RP	2000	6284		7.2	27	
381000	G3325TD-RP	3000	10350		10.8	29	
381017	G3326TD-RP	4000	13800	208	14.4	30	780
381048	G3327TD-RP	4800	16560		17.3		
398077	J3326TD-RP	4000	13800	208	11.11	30	820
398091	J3327TD-RP	4800	16560		13.33		
398084	K3326TD-RP	4000	13800	240	9.64	30	780
398107	K3327TD-RP	4800	16560		11.57		
International Models							
396424	M3324TD-RPi	3360/1680	11468/5734	220	15.3/7.64	27	648
396437	M3325TD-RPi	4032/2016	13761/6881		18.3/9.16		

Accessories

UPC 686334	MODEL	DESCRIPTION	TYPE	WT. lbs.	LIST
377850	BOX 3310	Additional Rough-in Box	Field Installed	3	99
378451	3320EX33	4" Surface Mounting Frame		1	90
382939	3320EX16	2" semi recess extender		1	77
----	Suffix - HD	16 Gauge Steel Heavy Duty Grill	Factory Installed	2	99

4400 Series Low Profile Commercial Fan Forced Wall Heater - With Wall Box

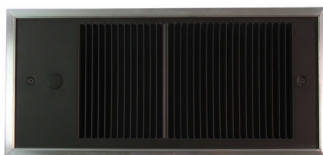

Manufactured in U.S.A.



- Powder coated 20 gauge steel front with extruded Aluminum frame.
- Manual reset thermal limit.
- Finned tubular steel element.

Standard Models

UPC 686334	MODEL	VOLTS	WATTS	MAX BTU'S	AMPS	LIST
DOUBLE POLE IN-BUILT THERMOSTAT (RANGE 50° - 90° F)						
328326	F4420T2RP	208	2000	6826	9.6	315
328333	HF4475T2RP	240/208	750 / 562	2560 / 1920	3.1 / 2.7	
328340	HF4410T2RP		1000 / 750	3413 / 2560	4.2 / 3.6	
328357	HF4415T2RP		1500 / 1125	5120 / 3840	6.3 / 5.4	
328364	HF4420T2RP		2000 / 1500	6826 / 5120	8.3 / 7.2	
SINGLE POLE IN-BUILT THERMOSTAT (RANGE 50° - 90° F)						
328371	E4475TRP	120	750	2560	6.25	296
328388	E4410TRP		1000	3413	8.33	
328395	E4415TRP		1500	5120	12.5	
328401	F4420TRP	208	2000	6826	9.6	

Accessories

UPC 686334	MODEL	DESCRIPTION	WT. LBS.	LIST
329910	4400EX8	1" SEMI RECESSING EXTENDER	2	44
329903	4400EX16	2" SEMI RECESSING EXTENDER	3	47
329897	4400EX32	4" SURFACE MOUNTING FRAME	4	49
328449	4300PB	WALL PLATE ADAPTOR (OD 21.5"x12.25")	1	32

- Propeller style fan blade - 2200 RPM/70 CFM
- Weight 9 lbs.
- Rough in dimensions:
14-1/2" Wide x 7-1/8" High x 3-1/2" Deep
- Grill dimensions: 16-7/8" Wide x 8" High
- Unit not approved for ceiling mount applications.
- Unit can be positioned to allow left, right or top discharge.

Note: Please see page 60 for custom color availability - add 10% to net heater cost.

3420 & 3450 Series Heavy-Duty Fan Forced Wall Heaters



Features

- Powder coated bar stock steel tamper proof grille, with extruded Aluminum frame and 16 gauge housing.
- In-Built double pole tamper proof thermostat with a 40°-110°F temperature range & positive off; 3 phase heaters have 3 pole thermostat for positive off position.
- Manual reset thermal limit switch.
- Corrosion resistant steel tubular element with brazed steel fins.
- Permanently lubricated, unit bearing, shaded pole motor with impedance protection.
- Propeller type fan blade:
1400 RPM motor; 245 CFM
- Factory installed options:
- contactors (3420 & 3450 series)
- circuit breakers (3450 series)
- control transformers (3450 series)

Note: Wall box required - may be ordered early for rough in purposes.



Manufactured in U.S.A.

Standard Models

HEATER		WALL BOX		WATTS	BTU's	VOLTS	PH	AMPS	WT.	HEATER LIST	WALL BOX LIST	TOTAL LIST
UPC 686334	MODEL	UPC 686334	MODEL									
SERIES 3420 - ROUGH-IN DIMENSIONS: 19-3/8" H x 14-1/4" W x 4-1/4" D												
GRILL DIMENSIONS: 21-15/32" H x 17-7/16" W												
691130	F3422T	691574	Box 3420	2000	6826	208	1	9.6	41 lbs.	957	157	1114
691192	H3422T					240		8.3				
691178	G3422T					277		7.2				
384629	J3422T			2000	6826	208	3	5.6		1123		
384643	K3422T					240		4.8				
691239	F3423T			3000	10239	208	1	14.4		981		
691314	H3423T					240		12.5				
691277	G3423T					277		10.8				
384636	J3423T			3000	10239	208	3	8.3		1123		
384650	K3423T					240		7.3				
691338	F3424T			4000	13652	208	1	19.2		1001		
691383	H3424T					240		16.7				
691369	G3424T					277		14.4				
691406	J3424T					208		11.1				
691413	K3424T					240		9.6				
691437	F3425T					5000		17065				208
691512	H3425T	240	20.8									
691482	G3425T	277	18.1									
691536	J3425T	208	13.9									
691567	K3425T	240	12.0									

HEATER		WALL BOX		WATTS	BTU's	VOLTS	PH	AMPS	WT.	HEATER LIST	WALL BOX LIST	TOTAL LIST
UPC 686334	MODEL	UPC 686334	MODEL									
SERIES 3450 - ROUGH-IN DIMENSIONS: 23-1/16" H x 14-1/4" W x 4-1/4" D												
GRILL DIMENSIONS: 25-1/32" H x 17-7/16" W												
691611	F3452T	691918	Box 3450	2000	6826	208	1	9.6	55 lbs.	1227	181	1409
691680	H3452T					240		8.3				
312295	G3452T					277		7.2				
384667	J3452T			2000	6826	208	3	5.6		1395		
384681	K3452T					240		4.8				
687683	F3453T			3000	10239	208	1	14.4		1242		
691772	H3453T					240		12.5				
312288	G3453T					277		10.8				
384674	J3453T			3000	10239	208	3	8.3		1395		
384698	K3453T					240		7.3				
691789	F3454T			4000	13652	208	1	19.2		1273		
691819	H3454T					240		16.7				
311991	G3454T					277		14.4				
691857	J3454T					208		11.1				
316651	K3454T					240		9.6				
312981	F3455T					5000		17065				208
312134	H3455T	240	20.8									
312387	G3455T	277	18.1									
691901	J3455T	208	13.9									
313070	K3455T	240	12.0									

Note: Please see page 60 for custom color availability - add 10% to net heater cost.

Note: Products listed in this section are custom built and subject to 100% cancellation/restocking charges.

Contractor shall supply and install heavy duty wall mounted forced air electric heaters of the wattage, voltage and phase as specified. The heater shall so be designed to provide an even distribution of heated air to the space to be heated by drawing return air in the peripheral area of the heater across and through the element which shall then be discharged from the center section of the heater by means of an electric motor and axial flow fan blade. Heaters shall be recessed type to extend no more than 1-1/2" from the finished wall or surface mounted to extend no more than 5-3/4" from the finished wall or semi-recessed type to extend no more than 3-1/2" from finished wall or semi-recessed type to extend no more than 2-1/2" from finished wall.

ENCLOSURE:

Heater front shall withstand 10.8 ft. lbs. (324 poundals) impact and 400 lbs. static force applied to an 8 sq. in. area at center grille location with less than 1/16" permanent distortion. The combination return and supply grille assembly shall be constructed of 1/16" x 3/8" rounded edge horizontal steel louvers which shall be spaced for maximum opening of 1/4". Louvers shall be welded at every intersection to three evenly spaced 1/16" diameter vertical members and completely framed in a heavy gauge natural anodized Aluminum extrusion. Front assembly shall be attached to the chassis by hidden tamper-resistant (Allen-head) machine screws. All other parts shall be 16 gauge steel Zinc coated, both sides finished in a high gloss or bronze colored baked powder coat finish.

MOTOR:

Motor shall be a permanently lubricated unit bearing, totally enclosed shaded pole type with impedance protection. Motors shall operate at no more than 1400 RPM and shall be same voltage as the heater. A protective shield shall surround the motor to separate return air from heated air.

PERFORMANCE:

Heaters shall have a rating of 245 CFM at 660 F.P.M. with a maximum temperature rise of 73°F.

ELEMENTS:

Element assemblies shall consist of two or three corrosion resistant steel sheathed type elements mechanically bonded to common corrosion resistant steel fins. Each sheathed element shall consist of helically coiled Nickel Chromium alloy resistant wire completely embedded in and surrounded by Magnesium Oxide, enclosed and wedged into corrosion resistant steel sheaths. Elements shall have 2" cold conductor pins extending into the sheath and shall have a density of no more than 60 Watts per inch.

THERMAL OVERLOAD:

Heaters shall be equipped with a "manual reset" thermal overload which disconnects elements and motor in the event normal operating temperatures are exceeded. For safety, if opened due to abnormal temperature, thermal overload shall remain open until manually reset. Automatic reset thermal overloads which allow the element to continue to cycle under abnormal conditions will not be accepted.

APPROVAL:

Heaters shall be ETL Listed.

OPTIONAL CONTROL SYSTEMS:

Heaters shall be operated from wall-mounted, line voltage, heavy-duty (tamper-proof) thermostats. Heaters with built-in, pre-wired contactors shall be operated from wall-mounted, line voltage, pilot duty (tamper-proof) thermostats. Heaters built with, pre-wired contactors (and control transformers) shall be operated from wall-mounted, pilot duty (24V) or (120V) wall-mounted tamper-proof thermostats. Heaters shall be controlled by integrally mounted thermostats. Thermostats shall be heavy-duty, hydraulic type with a range of 40°F to 80°F and with remote sensing bulb placed in the return air. Thermostats shall be electrically rated at least 125% of heater rating. Thermostats

Product Specifications

shall be heavy-duty, hydraulic type with a range of 40°F to 80°F and with remote sensing bulb placed in the return air. Thermostats shall be electrically rated at least 125% of heater rating. Thermostats shall also act as a disconnect by breaking all ungrounded conductors in the OFF position. (Thermostat control knob shall be covered by a 16 gauge tamper-proof access plate to prevent adjustment by unauthorized personnel.)

CONTACTORS:

Where required, heaters shall be equipped with heavy-duty, definite purpose contactors with flame path separators and dust covers. Contactors shall cycle all ungrounded conductors. Contactors shall have holding coils (of the same voltage as the heater) or (120 Volts) or (24 Volts).

CONTROL TRANSFORMERS:

Heater shall be equipped with a Class 2 control transformer, sealed rating of 20 VA, to supply control circuits of (24 Volts) or (120 Volts). (120 Volt secondaries not available in single phase heaters over 3 KW).

CIRCUIT BREAKERS (3450 Series Only):

Heaters shall be equipped with built-in circuit breakers in order to allow the heaters to be supplied from feeder taps. A separate switch providing a positive off for control circuits shall be included where required. Circuit breakers and control switches shall be arranged so that all line side conductors will be separately enclosed when heater front is removed for servicing so that no current carrying parts are accessible without the use of additional tools.

Field Installed Accessories

Units with transformers must have a contactor. A control transformer with 120V secondary is available on all 3-phase models, 208V/240V 1-phase units up to 3KW, and up to 4 KW on 277V. All heaters must be installed with a wall box.

MODEL	DESCRIPTION	SERIES OPTIONS		LIST
		3420	3450	
Suffix - R	Contactor with Coil same as heater	YES	YES	182
Suffix - R1	Contactor with 24V Coil	YES	YES	
Suffix - R2	Contactor with 120V Coil	YES	YES	
Suffix - C	Circuit Breakers - all models	NO	YES	340
Suffix - A1	Control Transformers With 24V Secondary	NO	YES	100
Suffix - A2	Control Transformers With 120V Secondary	NO	YES	134

UPC# 686334	MODEL	DESCRIPTION	WT.	LIST
691949	3450EX34	4" Surface Mounting Sleeve	6 lb.	101
691932	3450EX16	2" Semi-Recessing Sleeve	4 lb.	97
691925	3450EX8	1" Semi-Recessing Sleeve	4 lb.	78
691604	3420EX34	4" Surface Mounting Sleeve	5 lb.	101
691598	3420EX16	2" Semi-Recessing Sleeve	4 lb.	97
691581	3420EX8	1" Semi-Recessing Sleeve	3 lb.	78

3310 Series Fan Forced Wall Heater - Without Summer Fan Switch

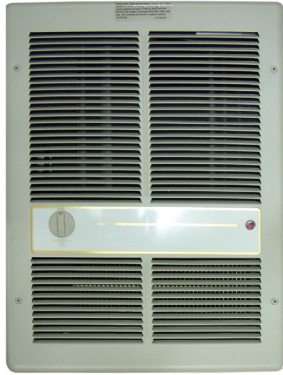

Features

- Powder coated 18 gauge steel front.
- Automatic reset thermal limit.
- Vane axial fan blade: 600 RPM / 175 CFM.
- Rough in dimensions: 14-3/16" Wide x 19-15/16" High x 4" Deep.
- Grill dimensions: 15-3/8" Wide x 20-9/64" High.
- Steel block fin element.
- Weight 22 lbs.
- Units with dual wattage, factory wired to highest wattage.
- Wattage selectable at time of installation on some models.



Manufactured in U.S.A.



Standard Models

MODELS WITH IN-BUILT DOUBLE POLE THERMOSTAT (50° - 90° F TEMPERATURE RANGE)								
IVORY		WHITE		WATTS	MAX BTU's	VOLTS	AMPS	LIST
UPC 686334	IVORY MODEL	UPC 686334	WHITE MODEL					
326346	E3312T2RP	326483	E3312T2RPW	1000	3413	120	8.3	488
326353	E3313T2RP	326490	E3313T2RPW	1500	5120		12.5	
				750	2560		6.25	
326360	F3316T2RP	326506	F3316T2RPW	4000	13648	208	19.2	496
326377	F3317T2RP	326513	F3317T2RPW	4800	16380		23	509
326407	HF3315T2RP	326544	HF3315T2RPW	3000 / 2250	10240	240 / 208	12.5 / 10.8	495
				1500 / 1125	5120		6.2 / 5.4	
326414	HF3316T2RP	326551	HF3316T2RPW	4000 / 3000	13648		16.8 / 14.4	
				2000 / 1500	6826	8.3 / 7.2	496	
326421	H3317T2RP	326568	H3317T2RPW	4800	16380	240	20.0	520
326438	G3314T2RP	326575	G3314T2RPW	2000	6826	277	7.2	495
326445	G3315T2RP	326582	G3315T2RPW	3000	10240		10.8	
326452	G3316T2RP	326599	G3316T2RPW	4000	13648		14.4	
326469	G3317T2RP	326605	G3317T2RPW	4800	16380		17.3	

MODELS WITH IN-BUILT SINGLE POLE THERMOSTAT (50° - 90° F TEMPERATURE RANGE)								
382526	E3312TRP	382618	E3312TRPW	1000	3413	120	8.3	455
380652	E3313TRP	384162	E3313TRPW	1500	5120		12.5	
				750	2560		6.25	
379946	F3316TRP	384186	F3316TRPW	4000	13648	208	19.2	463
380300	F3317TRP	384193	F3317TRPW	4800	16380		23	
380560	HF3315TRP	382229	HF3315TRPW	3000 / 2250	10240	240 / 208	12.5 / 10.8	476
				1500 / 1125	5120		6.2 / 5.4	
379984	HF3316TRP	382236	HF3316TRPW	4000 / 3000	13648		16.8 / 14.4	
				2000 / 1500	6826	8.3 / 7.2	463	
380317	H3317TRP	382243	H3317TRPW	4800	16380	240	20.0	486
329873	G3314TRP	384261	G3314TRPW	2000	6826	277	7.2	462
328494	G3315TRP	328517	G3315TRPW	3000	10240		10.8	
328500	G3316TRP	328524	G3316TRPW	4000	13648		14.4	
379179	G3317TRP	384292	G3317TRPW	4800	16380		17.3	

MODELS WITHOUT AN IN-BUILT THERMOSTAT								
326629	E3312RP	326766	E3312RPW	1000	3413	120	8.3	432
326636	E3313RP	326773	E3313RPW	1500	5120		12.5	
				750	2560		6.25	
328531	F3316RP	326780	F3316RPW	4000	13648	208	19.2	442
326650	F3317RP	326797	F3317RPW	4800	16380		23	455
326681	HF3315RP	326827	HF3315RPW	3000 / 2250	10240	240 / 208	12.5 / 10.8	442
				1500 / 1125	5120		6.2 / 5.4	
326698	HF3316RP	326834	HF3316RPW	4000 / 3000	13648		16.8 / 14.4	
				2000 / 1500	6826	8.3 / 7.2	442	
326704	H3317RP	326841	H3317RPW	4800	16380	240	20.0	465
326711	G3314RP	326858	G3314RPW	2000	6826	277	7.2	441
326728	G3315RP	326865	G3315RPW	3000	10240		10.8	
326735	G3316RP	326872	G3316RPW	4000	13648		14.4	
326742	G3317RP	326889	G3317RPW	4800	16380		17.3	

3310 Series Fan Forced Wall Heater - With Summer Fan Switch

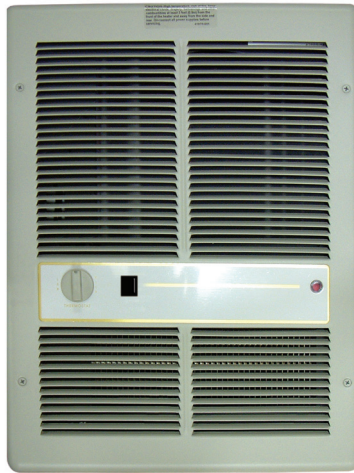

Features

- Powder coated 18 gauge steel front.
- Automatic reset thermal limit.
- Steel block fin element.
- Weight 22 lbs.
- Vane axial fan blade: 600 RPM / 175 CFM.
- Grill dimensions: 15-3/8" Wide x 20-9/64" High.
- Rough in dimensions: 14-3/16" Wide x 19-15/16" High x 4" Deep.
- Units with dual wattage, factory wired to highest wattage.
- Wattage selectable at time of installation on some models.



Manufactured in U.S.A.



Product Specifications

Typical Specifications: Furnish and install Electric Forced Air Heaters where specified. The heaters shall be constructed of a heavy gauge steel housing. The rough-in dimensions are 14-3/16" Wide x 19-5/16" High x 4" Deep. The finish shall be powder coated paint in ivory or white color. The units shall be available in ratings from 750 through 4800 Watts. The heaters shall have a low speed 600 RPM

motor which drives a vane axial blower to deliver a quiet 175 CFM of down flow air. The heating element shall be of the sealed block fin type with large, parallel steel fins for quick heat transfer. Unit shall have a standard thermal overload cutoff for added safety, a fan switch for fan only operation, and is available with a single pole, or double pole built-in thermostat, or no thermostat. The in-built thermostat shall be calibrated to provide a range of 50 degrees F. to 90 degrees F. All heaters shall be listed by ETL. The heating element shall be supplied with a manufacturer's 1 year limited warranty.

Standard Models

MODELS WITH IN-BUILT DOUBLE POLE THERMOSTAT (50° - 90°F TEMPERATURE RANGE)								
IVORY		WHITE		WATTS	MAX BTU's	VOLTS	AMPS	LIST
UPC 686334	IVORY	UPC 686334	WHITE					
326063	E3312T2SRP	326209	E3312T2SRPW	1000	3413	120	8.3	498
326070	E3313T2SRP	326216	E3313T2SRPW	1500	5120		12.5	
				750	2560		6.25	
326087	F3316T2SRP	326223	F3316T2SRPW	4000	13648	208	19.2	509
326094	F3317T2SRP	326230	F3317T2SRPW	4800	16380		23	521
326124	HF3315T2SRP	326261	HF3315T2SRPW	3000 / 2250	10240	240 / 208	12.5 / 10.8	509
				1500 / 1125	5120		6.2 / 5.4	
326131	HF3316T2SRP	326278	HF3316T2SRPW	4000 / 3000	13648		16.8 / 14.4	
				2000 / 1500	6826		8.3 / 7.2	
326148	H3317T2SRP	326285	H3317T2SRPW	4800	16380	240	20.0	530

MODELS WITH IN-BUILT SINGLE POLE THERMOSTAT (50° - 90°F TEMPERATURE RANGE)								
382571	E3312TSRP	382595	E3312TSRPW	1000	3413	120	8.3	467
379618	E3313TSRP	384018	E3313TSRPW	1500	5120		12.5	
				750	2560		6.25	
377713	F3316TSRP	384025	F3316TSRPW	4000	13648	208	19.2	476
377782	F3317TSRP	384032	F3317TSRPW	4800	16380		23	488
377607	HF3315TSRP	384070	HF3315TSRPW	3000 / 2250	10240	240 / 208	12.5 / 10.8	476
				1500 / 1125	5120		6.2 / 5.4	
377690	HF3316TSRP	384087	HF3316TSRPW	4000 / 3000	13648		16.8 / 14.4	
				2000 / 1500	6826		8.3 / 7.2	
377768	H3317TSRP	384094	H3317TSRPW	4800	16380	240	20.0	497
International Models								
----	----	396480	M3315T2SRPW	3360	11468	220	15.27	509
				1680	5734		7.64	
----	----	396493	M3316T2SRPW	4032	13761		18.33	
				2016	6881		9.16	

Note: Fan switch not available on 277V models. 277V models are available without a fan switch on previous page.

Accessories - All Models

IVORY		WHITE		DESCRIPTION	ACCESSORY TYPE	LIST
UPC 686334	MODEL	UPC 686334	MODEL			
377850	BOX3310	377850	BOX3310	ADDITIONAL BACK CAN	Field Installed	99
329958	3310EX33R	329965	3310EX33WR	SURFACE MOUNTING FRAME		85
SUFFIX D				DISCONNECT SWITCH	Factory Installed	108

3200 Series Midsized Fan Forced Wall Heater - With Wall Box



SHOWN WITH BUILT-IN THERMOSTAT

Features

- Units have white powder coat finish.
- Approved for horizontal mounting - right or left discharge.
- Drywall depth embossments on back can.
- Powder coated 18 gauge steel front.
- Manual reset thermal limit.
- Finned tubular steel element.
- Weight 6 lbs.
- Propeller style fan blade: 2200 RPM / 70 CFM.
- Optional field installed In-Built thermostat.
- Rough in dimensions: 9-1/4" Wide, 12-1/8" High, 3-5/8" Deep.
- Grill dimensions: 9-25/32" Wide, 13" High.



Manufactured in U.S.A.

"TWO WIRE INSTALLATION"

Standard Models

UPC 686334	MODEL	VOLTS	WATTS	MAX BTU'S	AMPS	LIST
BUILT-IN DOUBLE POLE (POSITIVE OFF) THERMOSTAT 50° - 90° F RANGE						
383462	F3220T2RPW	208	2000	6826	9.6	254
383479	H3275T2RPW	240	750	2560	3.1	
383486	HF3210T2RPW	240/208	1000 / 750	3413 / 2560	4.2 / 3.6	
383493	HF3215T2RPW		1500 / 1125	5120 / 3840	6.3 / 5.4	
383509	HF3220T2RPW		2000 / 1500	6826 / 5120	8.3 / 7.2	
383516	HF3222T2RPW		2250 / 1688	7680 / 5762	9.4 / 8.1	
International Models - BUILT-IN DOUBLE POLE (POSITIVE OFF) THERMOSTAT 50° - 90° F RANGE						
396387	M3210T2RPWi	220	840	2867	3.8	254
396394	M3215T2RPWi		1260	4300	5.7	
396400	M3220T2RPWi		1680	5734	7.6	
396417	M3222T2RPWi		1890	6451	8.6	
Standard Models - BUILT-IN SINGLE POLE (POSITIVE OFF) THERMOSTAT 50° - 90° F RANGE						
383523	E3275TRPW	120	750	2560	6.25	238
383530	E3210TRPW		1000	3413	8.33	
383547	E3215TRPW		1500	5120	12.5	
NO BUILT-IN THERMOSTAT						
383554	E3275RPW	120	750	2560	6.25	219
383561	E3210RPW		1000	3413	8.33	
383578	E3215RPW		1500	5120	12.5	
383585	F3220RPW	208	2000	6826	9.6	
383592	H3275RPW	240	750	2560	3.1	
383608	HF3210RPW	240/208	1000 / 750	3413 / 2560	4.2 / 3.6	
383615	HF3215RPW		1500 / 1125	5120 / 3840	6.3 / 5.4	
383622	HF3220RPW		2000 / 1500	6826 / 5120	8.3 / 7.2	
383639	HF3222RPW		2250 / 1688	7680 / 5762	9.4 / 8.1	

Accessories

FIELD INSTALLED COMPONENTS			
UPC 686334	MODEL	DESCRIPTION	LIST
383646	32T1	Single Pole thermostat with positive off for 120V units 50° - 90° F	48
383653	32T2	Double Pole thermostat with positive off for 240/208V units 50° - 90° F	54

SURFACE MOUNTED EXTENDERS & FRAMES			
WHITE		DESCRIPTION	LIST
UPC 686334	MODEL		
996976	303EX8RW	1" EXTENDER	39
996969	303EX16RW	2" EXTENDER	40
996952	303EX32RW	4" SURFACE MOUNT FRAME	46

4300 Series Low Profile Fan Forced Wall Heater - With Wall Box

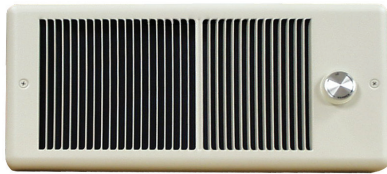

WITH IN-BUILT THERMOSTAT

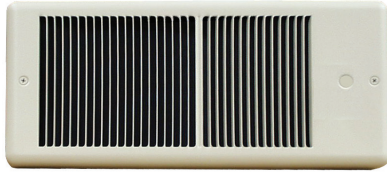

WITHOUT IN-BUILT THERMOSTAT

Features

- Available in ivory or white.
- Powder coated 20 gauge steel front.
- Manual reset thermal limit.
- Finned tubular steel element.
- Weight 9 lbs.
- Propeller style fan blade - 2200 RPM / 70 CFM
- Rough in dimensions: 14-1/2" Wide, 7-1/8" High, 3-1/2" Deep
- Grill dimensions: 16-3/4" Wide, 7-5/8" High
- Unit not approved for ceiling mount applications.
- Unit can be positioned to allow left, right or top discharge.



Manufactured in U.S.A.

Standard Models

IVORY		WHITE		VOLTS	WATTS	MAX BTU's	AMPS	LIST
UPC 686334	MODEL	UPC 686334	MODEL					
DOUBLE POLE IN-BUILT THERMOSTAT (RANGE 50° - 90°F)								
327695	F4320T2RP	327749	F4320T2RPW	208	2000	6826	9.6	245
327701	HF4375T2RP	327756	HF4375T2RPW	240/208	750 / 562	2560 / 1920	3.1 / 2.7	
327718	HF4310T2RP	327763	HF4310T2RPW		1000 / 750	3413 / 2560	4.2 / 3.6	
327725	HF4315T2RP	327770	HF4315T2RPW		1500 / 1125	5120 / 3840	6.3 / 5.4	
327732	HF4320T2RP	327787	HF4320T2RPW		2000 / 1500	6826 / 5120	8.3 / 7.2	
International Models - DOUBLE POLE IN-BUILT THERMOSTAT (RANGE 50° - 90°F)								
----	----	396448	M4375T2RPi	220	630	2150	2.9	250
----	----	396455	M4310T2RPi		840	2869	3.8	
----	----	396462	M4315T2RPi		1260	4300	5.7	
----	----	396479	M4320T2RPi		1680	5733	7.6	
Standard Models - SINGLE POLE INBUILT THERMOSTAT (RANGE 50° - 90°F)								
327794	E4375TRP	327879	E4375TRPW	120	750	2560	6.25	227
327800	E4310TRP	327886	E4310TRPW		1000	3413	8.33	
327817	E4315TRP	327893	E4315TRPW		1500	5120	12.5	
327824	F4320TRP	327909	F4320TRPW	208	2000	6826	9.6	
327831	HF4375TRP	327916	HF4375TRPW	240/208	750 / 562	2560 / 1920	3.1 / 2.7	
327848	HF4310TRP	327923	HF4310TRPW		1000 / 750	3413 / 2560	4.2 / 3.6	
327855	HF4315TRP	327930	HF4315TRPW		1500 / 1125	5120 / 3840	6.3 / 5.4	
327862	HF4320TRP	327947	HF4320TRPW		2000 / 1500	6826 / 5120	8.3 / 7.2	
NO IN-BUILT THERMOSTAT								
327954	E4375RP	328036	E4375RPW	120	750	2560	6.25	206
327961	E4310RP	328043	E4310RPW		1000	3413	8.33	
327978	E4315RP	328050	E4315RPW		1500	5120	12.5	
327985	F4320RP	328067	F4320RPW	208	2000	6826	9.6	
327992	HF4375RP	328074	HF4375RPW	240/208	750 / 562	2560 / 1920	3.1 / 2.7	
328005	HF4310RP	328081	HF4310RPW		1000 / 750	3413 / 2560	4.2 / 3.6	
328012	HF4315RP	328098	HF4315RPW		1500 / 1125	5120 / 3840	6.3 / 5.4	
328029	HF4320RP	328104	HF4320RPW		2000 / 1500	6826 / 5120	8.3 / 7.2	

Accessories

UPC 686334	IVORY MODEL	UPC 686334	WHITE MODEL	ACCESSORY OPTIONS	WT. LBS.	LIST
327657	4300EX8	328456	4300EX8W	1" SEMI RECESSING EXTENDER	2	43
327664	4300EX16	328463	4300EX16W	2" SEMI RECESSING EXTENDER	3	46
327671	4300EX32	328470	4300EX32W	4" SURFACE MOUNTING FRAME	4	49
327688	4300P	328487	4300PW	WALL PLATE ADAPTOR (OD 21.5" x 12.25")	1	31
FIELD INSTALLED THERMOSTATS		329774	43T	SINGLE POLE THERMOSTAT 50° - 90° F	1	46
		329781	43T2	DOUBLE POLE THERMOSTAT 50° - 90° F	1	52

4800 Series Register Style Fan Forced Wall Heater - With Wall Box

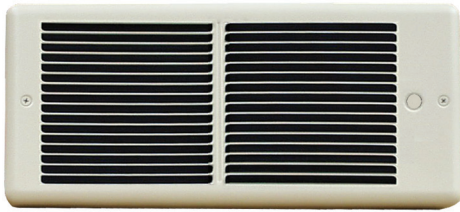

Manufactured in U.S.A.

Features

- Units have white powder coat finish.
- Powder coated 20 gauge steel front.
- Manual reset thermal limit.
- Finned tubular steel element.
- Propeller style fan blade - 2200 RPM / 70 CFM.
- Weight 9 lbs.
- Rough in dimensions: 14-1/2" Wide x 7-1/8" High x 3-1/2" Deep.
- Grill dimensions: 16-3/4" Wide x 7-5/8" High.
- Unit not approved for ceiling mount applications.
- Left discharge only.

Standard Models

UPC 686334	MODEL	VOLTS	WATTS	MAX BTU'S	AMPS	LIST
DOUBLE POLE IN-BUILT THERMOSTAT (50° - 90° F TEMPERATURE RANGE)						
328159	F4820T2RPW	208	2000	6826	9.6	264
328166	HF4875T2RPW	240/208	750 / 562	2560 / 1920	3.1 / 2.7	
328173	HF4810T2RPW		1000 / 750	3413 / 2560	4.2 / 3.6	
328180	HF4815T2RPW		1500 / 1125	5120 / 3840	6.3 / 5.4	
328197	HF4820T2RPW		2000 / 1500	6826 / 5120	8.3 / 7.2	
SINGLE POLE IN-BUILT THERMOSTAT (50° - 90° F TEMPERATURE RANGE)						
328203	E4875TRPW	120	750	2560	6.25	247
328210	E4810TRPW		1000	3413	8.33	
328227	E4815TRPW		1500	5120	12.5	
328234	F4820TRPW	208	2000	6826	9.6	
NO IN-BUILT THERMOSTAT						
328241	E4875RPW	120	750	2560	6.25	226
328258	E4810RPW		1000	3413	8.33	
328265	E4815RPW		1500	5120	12.5	
328272	F4820RPW	208	2000	6826	9.6	
328289	HF4875RPW	240/208	750 / 562	2560 / 1920	3.1 / 2.7	
328296	HF4810RPW		1000 / 750	3413 / 2560	4.2 / 3.6	
328302	HF4815RPW		1500 / 1125	5120 / 3840	6.3 / 5.4	
328319	HF4820RPW		2000 / 1500	6826 / 5120	8.3 / 7.2	

Accessories

UPC# 686334	MODEL	DESCRIPTION	WT. LBS.	LIST
328456	4300EX8W	1" SEMI RECESSING EXTENDER	2	43
328463	4300EX16W	2" SEMI RECESSING EXTENDER	3	46
328470	4300EX32W	4" SURFACE MOUNTING FRAME	4	49
328487	4300PW	WALL PLATE ADAPTOR (OD 21.5" x 12.25")	1	31
329774	43T	SINGLE POLE THERMOSTAT 50° - 90° F	1	46
329798	48T2	DOUBLE POLE THERMOSTAT 50° - 90° F	1	49

3900 Series Hydronic Electric Baseboard Heater



Manufactured in U.S.A.

- Permanent mount self contained unit.
- Heating elements are immersed in a heat transferring liquid enclosed by a Copper tube casing with Aluminum fins.
- Powder coated 12 gauge heavy duty extruded Aluminum housing with junction boxes located on each end of the unit.
- Automatic linear limit.
- Wire guard extends along the entire outlet area of the baseboard.
- Commercial Brown unit has in-built wireway.
- Special colors available, consult factory.
- Suitable for high altitude applications.
- 1 Year element warranty.

Standard Models

STANDARD WHITE		COMMERCIAL BROWN		WATTS	BTU's.	VOLTS	AMPS	HEATER LENGTH (IN.)	WT. (LBS)	WHITE LIST	BROWN LIST
UPC 686334	MODEL	UPC 686334	MODEL								
111416	E3904-28	111645	E3904-28C	400	1360	120	3.3	28	16	350	372
111423	F3904-28	111652	F3904-28C	400	1360	208	1.92				
111430	H3904-28	111669	H3904-28C	400/300	1360/1024	240/208	1.6/1.4				
111447	G3904-28	111676	G3904-28C	400/300	1360	277/240	1.4				
111454	E3906-36	111683	E3906-36C	600	2048	120	5	36	22	401	426
111461	F3906-36	111690	F3906-36C	600	2048	208	2.9				
111478	H3906-36	111706	H3906-36C	600/450	2048/1536	240/208	2.5/2.2				
111485	G3906-36	111713	G3906-36C	600/450	2048	277/240	2.2	48	27	467	495
111492	E3910-48	111720	E3910-48C	1000	3413	120	8.3				
111508	F3910-48	111737	F3910-48C	1000	3413	208	4.8				
111515	H3910-48	111744	H3910-48C	1000/750	3413/2560	240/208	4.2/3.6				
111522	G3910-48	111751	G3910-48C	1000/750	3413	277/240	3.6	60	33	531	578
111539	E3912-60	111768	E3912-60C	1250	4265	120	10.4				
111546	F3912-60	111775	F3912-60C	1250	4265	208	6				
111553	H3912-60	111782	H3912-60C	1250/938	4265/3201	240/208	5.2/4.5				
111560	G3912-60	111799	G3912-60C	1250/938	4265	277/240	3.6	72	41	597	639
111577	E3915-72	111805	E3915-72C	1500	5100	120	12.5				
111584	F3915-72	111812	F3915-72C	1500	5100	208	7.2				
111591	H3915-72	111829	H3915-72C	1500/1125	5100/3825	240/208	6.3/5.4				
111607	G3915-72	111836	G3915-72C	1500/1125	5100	277/240	5.4	96	58	709	763
111614	F3920-96	111842	F3920-96C	2000	6826	208	9.6				
111621	H3920-96	111850	H3920-96C	2000/1500	6826/5100	240/208	8.3/7.2				
111638	G3920-96	111867	G3920-96C	2000/1500	6826	277/240	7.2				

Product Specifications & Dimensions

The entire heater casing shall be constructed of 6063 extruded Aluminum. minimum thickness of .100" (12 gauge) Aluminum shall be acceptable. Outlet grill shall cover entire length of air discharge opening and be constructed of steel. All casing and grill construction shall be painted with high quality durable powder coated paint.

The heating element shall be high quality Nichrome wire encased in Magnesium Oxide and sealed in copper tube. The heating element shall be sealed in .312" diameter Copper tube and be immersed in heat transfer liquid. Aluminum fins shall be mechanically bonded to the entire heated length of the element for even heat transfer.

Linear automatic thermal limit shall extend the entire heater length of element and protect heater in case of an over-temperature condition.

Optional controls shall be mounted in junction box enclosures at either end of heater. Optional integral thermostat shall be located in junction box with adjustment knob or for tamper-proof operation. Optional disconnect switch shall be mounted in junction box. Optional 120 Volt or air conditioning receptacle shall be mounted in junction box.

Optional installation accessories shall include inside and outside corner sections for complete wall perimeter fit. Profile of corners and grill shall have appearance of heat sections for continuous architectural design. Corner accessories and heater sections shall be secured by alignment pins for easy alignment of multiple heater applications.

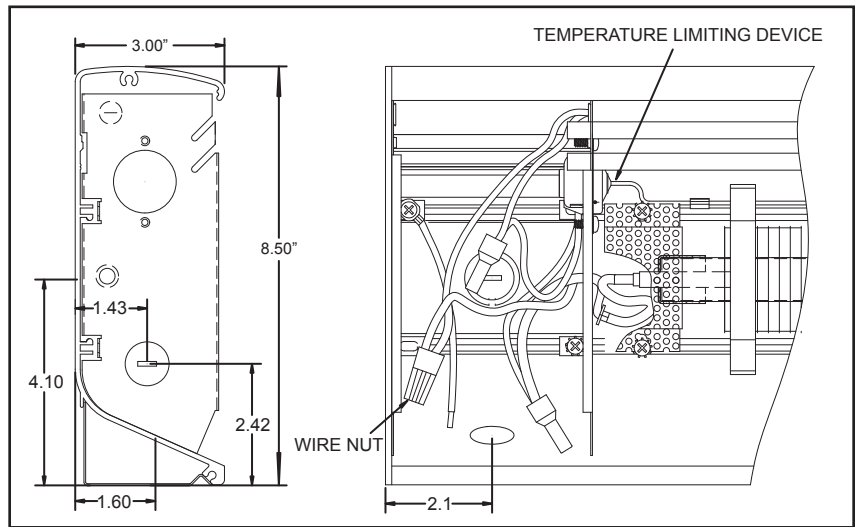

3700 Series Architectural Style Electric Baseboard Heater

- Available in white or brown with stainless steel heating element and aluminum fins.
- Powder coated 12 gauge heavy duty extruded Aluminum housing construction with junction boxes located on each end of the unit.
- An automatic thermal linear limit is used along the entire heated length of the unit.
- Wire guard extends along the entire outlet area of the baseboard.
- Special colors available, consult factory.

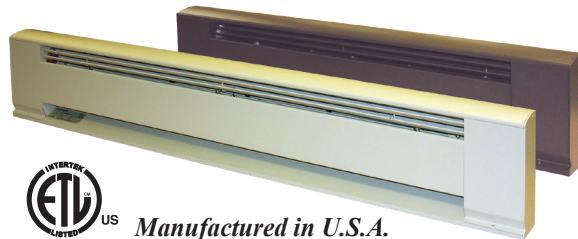

Standard Models

Product Specifications

STANDARD WHITE		COMMERCIAL BROWN		WATTS	BTU's	VOLTS	AMPS	HEATER LENGTH (IN.)	WT. (LBS.)	WHITE LIST	BROWN LIST
UPC 686334	MODEL	UPC 686334	MODEL								
116008	E3703-024	116435	E3703-024B	375	1275	120	3.1	24	14	299	311
116015	F3703-024	116442	F3703-024B	375	1275	208	1.8				
116022	H3703-024	116459	H3703-024B	375 / 281	1275 / 955	240 / 208	1.6/1.4				
116039	G3703-024	116466	G3703-024B	375 / 281	1275 / 955	277 / 240	1.6/1.2				
116046	E3705-028	116473	E3705-028B	500	1706	120	4.2	28	16	331	344
116053	F3705-028	116480	F3705-028B	500	1706	208	2.4				
116060	H3705-028	116497	H3705-028B	500 / 375	1706 / 1275	240 / 208	2.1/1.8				
116077	G3705-028	116503	G3705-028B	500 / 375	1706 / 1275	277 / 240	1.8/1.6				
116084	E3706-036	116510	E3706-036B	600	2040	120	5	36	22	382	396
116091	F3706-036	116527	F3706-036B	600	2040	208	2.9				
116107	H3706-036	116534	H3706-036B	600 / 450	2040 / 1530	240 / 208	2.5/2.2				
116114	G3706-036	116541	G3706-036B	600 / 450	2040 / 1530	277 / 240	2.2/1.9				
116121	E3707-040	116558	E3707-040B	750	2550	120	6.3	40	27	389	402
116138	F3707-040	116565	F3707-040B	750	2550	208	3.6				
116145	H3707-040	116572	H3707-040B	750 / 563	2550 / 1914	240 / 208	3.1/2.7				
116152	G3707-040	116589	G3707-040B	750 / 563	2550 / 1914	277 / 240	2.7/2.6				
116169	E3710-048	116596	E3710-048B	1000	3413	120	8.3	48	31	402	415
116176	F3710-048	116602	F3710-048B	1000	3413	208	4.8				
116183	H3710-048	116619	H3710-048B	1000 / 750	3413 / 2550	240 / 208	4.2/3.6				
116190	G3710-048	116626	G3710-048B	1000 / 750	3413 / 2550	277 / 240	3.6/3.1				
116206	G3707-048	116633	G3707-048B	750	2550	277	3.4	60	33	526	539
116213	E3712-060	116640	E3712-060B	1250	4250	120	10.4				
116220	F3712-060	116657	F3712-060B	1250	4250	208	6				
116237	H3712-060	116664	H3712-060B	1250 / 938	4250 / 3189	240 / 208	5.2/4.5				
116244	G3712-060	116671	G3712-060B	1250 / 938	4250 / 3189	277 / 240	4.5/3.9	72	41	589	603
116251	G3709-060	116688	G3709-060B	938	3189	277	3.4				
116268	E3715-072	116695	E3715-072B	1500	5100	120	12.5				
116275	F3715-072	116701	F3715-072B	1500	5100	208	7.2				
116282	H3715-072	116718	H3715-072B	1500 / 1125	5100 / 3825	240 / 208	6.3/4.7	84	49	661	674
116299	G3715-072	116725	G3715-072B	1500 / 1125	5100 / 3825	277 / 240	5.4/4.7				
116305	G3711-072	116732	G3711-072B	1125	3825	277	4.1				
116312	F3717-084	116749	F3717-084B	1750	5950	208	8.4				
116329	H3717-084	116756	H3717-084B	1750 / 1313	5950 / 4464	240 / 208	7.3/6.3	96	58	698	719
116336	G3717-084	116763	G3717-084B	1750 / 1313	5950 / 4464	277 / 240	6.3/5.5				
116343	G3713-084	116770	G3713-084B	1313	4464	277	4.7				
116350	F3720-096	116787	F3720-096B	2000	6826	208	9.6				
116367	H3720-096	116794	H3720-096B	2000 / 1500	6826 / 5100	240 / 208	8.3/7.2	120	67	785	797
116374	G3720-096	116800	G3720-096B	2000 / 1500	6826 / 5100	277 / 240	7.2/6.3				
116381	G3715-096	116817	G3715-096B	1500	5100	277	5.4				
116398	F3725-120	116824	F3725-120B	2500	8532	208	12				
116404	H3725-120	116831	H3725-120B	2500 / 1875	8532 / 6375	240 / 208	10.4/9.0	120	67	785	797
116411	G3725-120	116848	G3725-120B	2500 / 1875	8532 / 6375	277 / 240	9.0/7.8				
116428	G3718-120	116855	G3718-120B	1875	6375	277	6.8				

The entire heater casing shall be constructed of 6063 extruded Aluminum. Minimum thickness of .100" (12 gauge) Aluminum shall be acceptable. Outlet grill shall cover entire length of air discharge opening and be constructed of steel. All casing and grill construction shall be painted with high quality durable powder coated paint.

The heating element shall be high quality nichrome wire encased in Magnesium Oxide and sealed in a stainless steel tube.

Linear automatic thermal limit shall extend the entire heater length of element and protect heater in case of an over-temperature condition.

Optional controls shall be mounted in junction box enclosures at either end of heater. Optional integral thermostat shall be located in junction box with adjustment knob or for tamper-proof operation. Optional disconnect switch shall be mounted in junction box. Optional 120 Volt or air conditioning receptacle shall be mounted in junction box.

Optional installation accessories shall include inside and outside corner sections for complete wall perimeter fit. Profile of corners and grill shall have appearance of heat sections for continuous architectural design. Corner accessories and heater sections shall be secured by alignment pins for easy alignment of multiple heater applications.

Note: Refer to 3900 Series for product dimension specifications.
 Note: Please see page 60 for custom color availability - add 10% to net heater cost.

Field Installed Accessories

DESCRIPTION	Standard White		Commercial Brown		LIST
	UPC# 686334	MODEL	UPC# 686334	MODEL	
Single Pole, In-Built T-Stat, 22A @ 120-240V; 18A @ 277V; 50°-90° F	111874	3900T1	111959	3900T1C	61
Double Pole, In-Built T-Stat, 22A @ 120-240V; 18A @ 277V; 50°-90° F	111881	3900T2	111966	3900T2C	79
Air Conditioning Receptacle Section, 20 Amp @ 125-277V	111898	3900AC	111997	3900ACC	72
120V. Receptacle Section, 15 Amp	111904	3900REC	112000	3900RECC	67
Disconnect Switch, 20 Amp @ 125-277VAC; DPST	111942	3900DS	112048	3900DSC	99

Baseboard Sections



OUTSIDE CORNER



INSIDE CORNER

Outside and inside corner sections are 6" on longest side

STANDARD WHITE		COMMERCIAL BROWN		DESCRIPTION		LIST
UPC# 686334	MODEL	UPC# 686334	MODEL	SECTION	SIZE	
112154	39BS28	112215	39BS28C	Blank Section	28"	215
112161	39BS36	112222	39BS36C		36"	256
112178	39BS48	112239	39BS48C		48"	317
112185	39BS60	112246	39BS60C		60"	380
112192	39BS72	112253	39BS72C		72"	438
112208	39BS96	112260	39BS96C		96"	563
115094	39BS120	115100	39BS120C		120"	751
111911	3900-ICS	112017	3900-ICSC	Inside Corner		123
111928	3900-OCS	112024	3900-OCSC	Outside Corner		125
111935	3900-CS	112031	3900-CSC	Control Section	4" Blank	157

Dimension

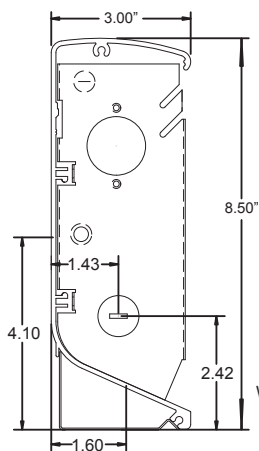

TEMPERATURE LIMITING DEVICE

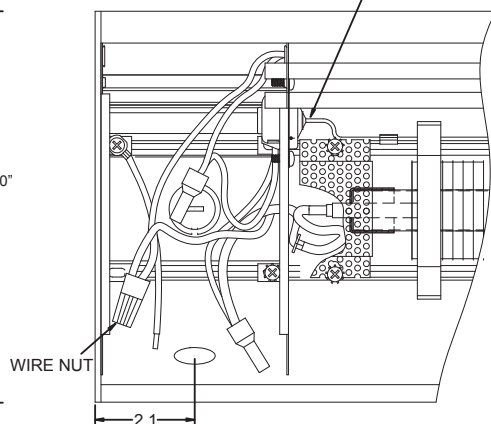

Wireway Covers (White Units Only)

UPC# 686334	MODEL	LENGTH	SHIP WT. (LBS)	LIST
112284	3900WW28	28"	2	47
112291	3900WW36	36"	2.5	52
112307	3900WW48	48"	3.5	62
112314	3900WW60	60"	4.5	68
112321	3900WW72	72"	5.5	73
112338	3900WW96	96"	7.5	96
115117	3900WW120	120"	7.5	129

2900HA Series Electric Baseboard - High Altitude Convection Heater



Manufactured in U.S.A.

Features

- Available in white or ivory with Aluminum heating element and Aluminum fins.
- Painted 22 gauge steel front with 20 gauge junction boxes located on each end of the heater - junction boxes contain quick connect cable clamps and 6" ground lead wires.
- Over-temperature thermal limit extends entire length of heated area.
- A full length wireway provided along the back of the heater.
- Optional enclosed conduit wireway available.
- Heater can be mounted to the wall by using the key hole knockouts every 4" at the back of the heater.
- Optional In-Built thermostats field installed in the junction box.
- HEIGHT: 6" DEPTH: 2-1/2"
- Ivory available with extended lead times-consult factory.

Standard Models

UPC# 686334	WHITE MODEL	WATTS	BTU's	VOLTS	AMPS	HEATER LENGTH (IN)	WT. (LBS.)	LIST
101226	E2903-024HAW	375	1275	120	3.1	24	5	62
101233	F2903-024HAW	375	1275	208	1.8			
101240	H2903-024HAW	375 / 281	1275 / 955	240 / 208	1.6/1.4			
101257	G2903-024HAW	375 / 281	1275 / 955	277 / 240	1.6/1.2	28	6	64
101264	E2905-028HAW	500	1706	120	4.2			
101271	F2905-028HAW	500	1706	208	2.4			
101288	H2905-028HAW	500 / 375	1706 / 1275	240 / 208	2.1/1.8	36	7	71
101295	G2905-028HAW	500 / 375	1706 / 1275	277 / 240	1.8/1.6			
101301	E2906-036HAW	600	2040	120	5			
101318	F2906-036HAW	600	2040	208	2.9	40	8	74
101325	H2906-036HAW	600 / 450	2040 / 1530	240 / 208	2.5/2.2			
101332	G2906-036HAW	600 / 450	2040 / 1530	277 / 240	2.2/1.9			
101349	E2907-040HAW	750	2550	120	6.3	48	10	89
101356	F2907-040HAW	750	2550	208	3.6			
101363	H2907-040HAW	750 / 563	2550 / 1914	240 / 208	3.1/2.7			
101370	G2907-040HAW	750 / 563	2550 / 1914	277 / 240	2.7/2.6	60	12	111
101387	E2910-048HAW	1000	3413	120	8.3			
101394	F2910-048HAW	1000	3413	208	4.8			
101400	H2910-048HAW	1000 / 750	3413 / 2550	240 / 208	4.2/3.6	72	14	125
101417	G2910-048HAW	1000 / 750	3413 / 2550	277 / 240	3.6/3.1			
101424	G2907-048HAW	750	2550	277	3.4			
101431	E2912-060HAW	1250	4250	120	10.4	96	18	153
101448	F2912-060HAW	1250	4250	208	6			
101455	H2912-060HAW	1250 / 938	4250 / 3189	240 / 208	5.2/4.5			
101462	G2912-060HAW	1250 / 938	4250 / 3189	277 / 240	4.5/3.9	120	22	169
101479	G2909-060HAW	938	3189	277	3.4			
101486	E2915-072HAW	1500	5100	120	12.5			
101493	F2915-072HAW	1500	5100	208	7.2	96	18	153
101509	H2915-072HAW	1500 / 1125	5100 / 3825	240 / 208	6.3/4.7			
101516	G2915-072HAW	1500 / 1125	5100 / 3825	277 / 240	5.4/4.7			
101523	G2911-072HAW	1125	3825	277	4.1	120	22	169
101578	F2920-096HAW	2000	6826	208	9.6			
101585	H2920-096HAW	2000 / 1500	6826 / 5100	240 / 208	8.3/7.2			
101592	G2920-096HAW	2000 / 1500	6826 / 5100	277 / 240	7.2/6.3	120	22	169
101608	F2915-096HAW	1500	5100	277	5.4			
101653	F2925-120HAW	2500	8532	208	12			
101660	H2925-120HAW	2500 / 1875	8532 / 6375	240 / 208	10.4/9.0	120	22	169
101677	G2925-120HAW	2500 / 1875	8532 / 6375	277 / 240	9.0/7.8			
101684	G2918-120HAW	1875	6375	277	6.8			

2900A Series - International Models

UPC# 686334	WHITE MODEL	WATTS	BTU's	VOLTS	HEATER LENGTH (IN)	WEIGHT (LBS)	LIST
115766	M2903-24AWi	375	1275	220	24"	10	81
115773	H2903-24AWi			240			
115780	M2905-28AWi	500	1706	220	28"	11	84
115977	H2905-28AWi			240			
115803	M2906-36AWi	600	2040	220	36"	11.5	93
115810	H2906-36AWi			240			
115827	M2907-40AWi	750	2550	220	40"	13	97
115834	H2907-40AWi			240			
115841	M2910-48AWi	1000	3413	220	48"	14	116
115858	H2910-48AWi			240			
115865	M2912-60AWi	1250	4250	220	60"	16	145
115872	H2912-60AWi			240			
115889	M2915-72AWi	1500	5100	220	72"	19	163
115896	H2915-72AWi			240			
115902	M2917-84AWi	1750	5950	220	80"	22	199
118002	H2917-84AWi			240			
118033	M2925-120AWi	2500	8532	220	120"	31	220
118040	H2920-120AWi			240			

Wireway Length Same As Baseboard Length

Features



Manufactured in U.S.A.

- Available in white or ivory with stainless steel heating element and Aluminum fins.
- Painted 22 gauge steel front with 20 gauge junction boxes located on each end of the heater - junction boxes contain quick connect cable clamps and 6" ground lead wires.
- Over-temperature thermal limit extends entire length of heated area.
- A full length wireway provided along the back of the heater - enclosed conduit available.
- Heater can be mounted to the wall by using the key hole knockouts every 4" at the back of the heater.
- Optional In-Built thermostats field installed in the junction box.
- HEIGHT: 6" DEPTH: 2-1/2"

Standard Models

UPC 686334	IVORY MODEL	UPC 686334	WHITE MODEL	WATTS	BTU's	VOLTS	AMPS	HEATER LENGTH (IN)	WT. (LBS.)	LIST
104302	E2903-024S	104999	E2903-024SW	375	1275	120	3.1	24	5	60
104319	F2903-024S	105002	F2903-024SW	375	1275	208	1.8			
104326	H2903-024S	105019	H2903-024SW	375 / 281	1275 / 955	240 / 208	1.6/1.4			
104333	G2903-024S	105026	G2903-024SW	375 / 281	1275 / 955	277 / 240	1.6/1.2			
104340	E2905-028S	105033	E2905-028SW	500	1706	120	4.2	28	6	62
104357	F2905-028S	105040	F2905-028SW	500	1706	208	2.4			
104364	H2905-028S	105057	H2905-028SW	500 / 375	1706 / 1275	240 / 208	2.1/1.8			
104371	G2905-028S	105064	G2905-028SW	500 / 375	1706 / 1275	277 / 240	1.8/1.6			
104388	E2906-036S	105071	E2906-036SW	600	2040	120	5	36	7	70
104395	F2906-036S	105088	F2906-036SW	600	2040	208	2.9			
104401	H2906-036S	105095	H2906-036SW	600 / 450	2040 / 1530	240 / 208	2.5/2.2			
104418	G2906-036S	105101	G2906-036SW	600 / 450	2040 / 1530	277 / 240	2.2/1.9			
104425	E2907-040S	105118	E2907-040SW	750	2550	120	6.3	40	8	72
104432	F2907-040S	105125	F2907-040SW	750	2550	208	3.6			
104449	H2907-040S	105132	H2907-040SW	750 / 563	2550 / 1914	240 / 208	3.1/2.7			
104456	G2907-040S	105149	G2907-040SW	750 / 563	2550 / 1914	277 / 240	2.7.2.6			
104463	E2910-048S	105156	E2910-048SW	1000	3413	120	8.3	48	10	87
104470	F2910-048S	105163	F2910-048SW	1000	3413	208	4.8			
104487	H2910-048S	105170	H2910-048SW	1000 / 750	3413 / 2550	240 / 208	4.2/3.6			
104494	G2910-048S	105187	G2910-048SW	1000 / 750	3413 / 2550	277 / 240	3.6/3.1			
104500	G2907-048S	105194	G2907-048SW	750	2550	277	3.4	60	12	107
104517	E2912-060S	105200	E2912-060SW	1250	4250	120	10.4			
103008	F2912-060S	105217	F2912-060SW	1250	4250	208	6			
103015	H2912-060S	105224	H2912-060SW	1250 / 938	4250 / 3189	240 / 208	5.2/4.5			
103022	G2912-060S	105231	G2912-060SW	1250 / 938	4250 / 3189	277 / 240	4.5/3.9	72	14	123
103039	G2909-060S	105248	G2909-060SW	938	3189	277	3.4			
103046	E2915-072S	105255	E2915-072SW	1500	5100	120	12.5			
103053	F2915-072S	105262	F2915-072SW	1500	5100	208	7.2			
103060	H2915-072S	105279	H2915-072SW	1500 / 1125	5100 / 3825	240 / 208	6.3/4.7	84	16	135
103077	G2915-072S	105286	G2915-072SW	1500 / 1125	5100 / 3825	277 / 240	5.4/4.7			
103084	G2911-072S	105293	G2911-072SW	1125	3825	277	4.1			
103091	F2917-084S	105309	F2917-084SW	1750	5950	208	8.4			
103107	H2917-084S	105316	H2917-084SW	1750 / 1313	5950 / 4464	240 / 208	7.3/6.3	96	18	150
103114	G2917-084S	105323	G2917-084SW	1750 / 1313	5950 / 4464	277 / 240	6.3/5.5			
103121	G2913-084S	105330	G2913-084SW	1313	4464	277	4.7			
103138	F2920-096S	105347	F2920-096SW	2000	6826	208	9.6			
103145	H2920-096S	105354	H2920-096SW	2000 / 1500	6826 / 5100	240 / 208	8.3/7.2	120	22	164
103152	G2920-096S	105361	G2920-096SW	2000 / 1500	6826 / 5100	277 / 240	7.2/6.3			
103169	G2915-096S	105378	G2915-096SW	1500	5100	277	5.4			
103213	F2925-120S	105422	F2925-120SW	2500	8532	208	12			
103220	H2925-120S	105439	H2925-120SW	2500 / 1875	8532 / 6375	240 / 208	10.4/9.0	120	22	164
103237	G2925-120S	105446	G2925-120SW	2500 / 1875	8532 / 6375	277 / 240	9.0/7.8			
103244	G2918-120S	105453	G2918-120SW	1875	6375	277	6.8			

2900C Series Electric Baseboard - Heavy Duty Commercial Convection Heater



Manufactured in U.S.A.



Features

- Bankers bronze with stainless steel heating element and Aluminum fins.
- Powder coated 22 gauge steel front with 20 gauge junction boxes located on each end of the heater - junction boxes contain quick connect cable clamps and 6" ground lead wires.
- Standard inlet and outlet wire guards.
- Over-temperature thermal limit extends entire heated length of unit.
- A full length wireway provided along the back of the heater.
- Heater can be mounted to the wall by using the key hole knockouts every 4" at the back of the heater.
- Optional In-Built thermostats field installed in the junction box.
- HEIGHT: 6" DEPTH: 2-1/2"

Standard Models

UPC# 686334	BRONZE MODEL	WATTS	BTU's	VOLTS	AMPS	HEATER LENGTH (IN)	WEIGHT (LBS)	LIST
103831	E2903-024C	375	1275	120	3.1	24	5	137
103848	F2903-024C	375	1275	208	1.8			
103855	H2903-024C	375 / 281	1275 / 955	240 / 208	1.6 / 1.4			
103862	G2903-024C	375 / 281	1275 / 955	277 / 240	1.6 / 1.2	28	6	171
103879	E2905-028C	500	1706	120	4.2			
103886	F2905-028C	500	1706	208	2.4			
103893	H2905-028C	500 / 375	1706 / 1275	240 / 208	2.1 / 1.8	36	7	195
103909	G2905-028C	500 / 375	1706 / 1275	277 / 240	1.8 / 1.6			
103916	E2906-036C	600	2040	120	5.0			
103923	F2906-036C	600	2040	208	2.9	40	8	204
103930	H2906-036C	600 / 450	2040 / 1530	240 / 208	2.5 / 2.2			
103947	G2906-036C	600 / 450	2040 / 1530	277 / 240	2.2 / 1.9			
103954	E2907-040C	750	2550	120	6.3	48	10	236
103961	F2907-040C	750	2550	208	3.6			
103978	H2907-040C	750 / 563	2550 / 1914	240 / 208	3.1 / 2.7			
103985	G2907-040C	750 / 563	2550 / 1914	277 / 240	2.7 / 2.6	60	12	282
103992	E2910-048C	1000	3413	120	8.3			
104005	F2910-048C	1000	3413	208	4.8			
104012	H2910-048C	1000 / 750	3413 / 2550	240 / 208	4.2 / 3.6	72	14	324
104029	G2910-048C	1000 / 750	3413 / 2550	277 / 240	3.6 / 3.1			
104036	G2907-048C	750	2550	277	3.4			
104043	E2912-060C	1250	4250	120	10.4	84	16	360
104050	F2912-060C	1250	4250	208	6.0			
104067	H2912-060C	1250 / 938	4250 / 3189	240 / 208	5.2 / 4.5			
104074	G2912-060C	1250 / 938	4250 / 3189	277 / 240	4.5 / 3.9	96	18	398
104081	G2909-060C	938	3189	277	3.4			
104098	E2915-072C	1500	5100	120	12.5			
104104	F2915-072C	1500	5100	208	7.2	120	22	418
104111	H2915-072C	1500 / 1125	5100 / 3825	240 / 208	6.3 / 4.7			
104128	G2915-072C	1500 / 1125	5100 / 3825	277 / 240	5.4 / 4.7			
104135	G2911-072C	1125	3825	277	4.1	84	16	360
104142	F2917-084C	1750	5950	208	8.4			
104159	H2917-084C	1750 / 1313	5950 / 4464	240 / 208	7.3 / 6.3			
104166	G2917-084C	1750 / 1313	5950 / 4464	277 / 240	6.3 / 5.5	96	18	398
104173	G2913-084C	1313	4464	277	4.7			
104180	F2920-096C	2000	6826	208	9.6			
104197	H2920-096C	2000 / 1500	6826 / 5100	240 / 208	8.3 / 7.2	120	22	418
104203	G2920-096C	2000 / 1500	6826 / 5100	277 / 240	7.2 / 6.3			
104210	G2915-096C	1500	5100	277	5.4			
104265	F2925-120C	2500	8532	208	12.0	84	16	360
104272	H2925-120C	2500 / 1875	8532 / 6375	240 / 208	10.4 / 9.0			
104289	G2925-120C	2500 / 1875	8532 / 6375	277 / 240	9.0 / 7.8			
104296	G2918-120C	1875	6375	277	6.8			

International Models

UPC# 686334	BRONZE MODEL	WATTS	BTU's	VOLTS	AMPS	HEATER LENGTH (IN)	WEIGHT (LBS)	LIST
118057	M2903-024CI	375	1275	220	1.7	24	5	137
118064	H2903-024CI			240	240			
118071	M2905-028CI	500	1706	220	2.3	28	6	171
118088	H2905-028CI			240	2.1			
118095	M2906-036CI	600	2040	220	2.7	36	7	195
118101	H2906-036CI			240	2.5			
118118	M2907-040CI	750	2550	220	3.4	40	8	204
118125	H2907-040CI			240	3.1			
118132	M2910-048CI	1000	3413	220	4.6	48	10	236
118149	H2910-048CI			240	4.2			
118156	M2912-060CI	1250	4250	220	5.7	60	12	282
118163	H2912-060CI			240	5.2			
118170	M2915-072CI	1500	5100	220	6.8	72	14	324
118187	H2915-072CI			240	6.3			
118194	M2917-084CI	1750	5950	220	8.0	84	16	360
118200	H2917-084CI			240	7.3			
118217	M2920-096CI	2000	6826	220	9.1	96	18	398
118224	H2920-096CI			240	8.3			
118231	M2925-120CI	2500	8532	220	11.4	120	22	418
118248	H2925-120CI			240	10.4			

Electric Baseboard - Accessories

In-Built Thermostat Kits- With Two Cover Plates

IVORY & WHITE		DESCRIPTION	WEIGHT (LBS)	LIST
UPC 686334	MODEL NUMBER			
105460	TBS	SPST-In-Built 22A @ 120-240V 18A @ 277V	1/2 lbs.	40
502702	TBS-TP	SPST-In-Built 22A @ 120-240V 18A @ 277V Tamperproof		
105477	TBD	DPST-In-Built 22A @ 120-240V 18A @ 277V	1/2 lbs.	52
502719	TBD-TP	DPST-In-Built 22A @ 120-240V 18A @ 277V Tamperproof		

Field Installed Accessories

DESCRIPTION	IVORY		WHITE		BANKERS BRONE		WEIGHT (LBS)	LIST
	UPC 686334	MODEL	UPC 686334	MODEL	UPC 686334	MODEL		
Disconnect Switch, 20 Amp, 120-277V	106108	DS	106115	DSW	106122	DSB	1 lb.	78
Corner Sections	105491	CS	105507	CSW	105514	CSB		34
1" Joiner Kits	105521	JK	105538	JKW	105545	JKB	1/4 lb.	23
6" Blank Relay Section (Relay Not Included)**	105552	LVRS	105569	LVRSW	105576	LVRSB	1 1/2 lbs.	95
Receptacle Section (Baseboard Mounted) 15 Amp 120 VAC	105583	BDR115	105590	BDR115W	105606	BDR115B	1/4 lb.	23
Receptacle Section (Mounted in 6" Blank) 15 Amp 120 VAC	105613	DR115	105620	DR115W	105637	DR115B	2 lbs.	110
Transfer Switch (Mounted in 6" Blank) 16 Amp 120 VAC	105644	SR120	105651	SR120W	105668	SR120B		139
Transfer Switch (Mounted in 6" Blank) 16 Amp 240 VAC	105675	SR220	105682	SR220W	105699	SR220B		169

**Not for use with 24A06G-1 relay.

Optional Wireway Covers

UPC 686334	MODEL	BASEBOARD LENGTH (in.)	COVER LENGTH (in.)	WEIGHT (LBS)	LIST
105705	WWA01	24	20	1	33
105712	WWA02	28	24	1.5	36
105729	WWA03	36	32	2	39
105736	WWA04	40	36	2.5	45
105743	WWA05	48	44	3	47
105750	WWA06	60	56	4	50
105767	WWA07	72	68	5	57
105774	WWA08	84	80	6	65
105781	WWA09	96	92	7	75
105798	WWA00	120	116	8	91

Blank Sections

LENGTH	IVORY		WHITE		BANKERS BRONZE		WEIGHT (LBS)	IVORY WHITE LIST	BRONZE LIST
	UPC	MODEL	UPC	MODEL	UPC	MODEL			
24"	105804	BBS024A	105903	BBS024AW	106009	BBS024C	5	52	107
28"	105811	BBS028A	105910	BBS028AW	106016	BBS028C	5 1/2	57	117
36"	105828	BBS036A	105927	BBS036AW	106023	BBS036C	6	69	135
40"	105835	BBS040A	105934	BBS040AW	106030	BBS040C	7	74	142
48"	105842	BBS048A	105941	BBS048AW	106047	BBS048C	8	83	146
60"	105859	BBS060A	105958	BBS060AW	106054	BBS060C	10	100	202
72"	105866	BBS072A	105965	BBS072AW	106061	BBS072C	12	120	222
84"	105873	BBS084A	105972	BBS084AW	106078	BBS084C	15	126	253
96"	105880	BBS096A	105989	BBS096AW	106085	BBS096C	17	147	283
120"	105897	BBS120A	105996	BBS120AW	106092	BBS120C	20	180	357

9100 Series - Radius Front Draft Barrier Heater

ETL listed up to 250 Watts / foot for industrial, commercial, or residential applications.



Manufactured in U.S.A.

Features

- Standard colors, white or ivory.
- “UNI-LOCK” construction allows snap-fit, 2 piece installation.
- Units can be controlled by optional In-Built thermostat or can be constructed with relays and / or transformers for low voltage or line voltage wall thermostats
- Thermal protection by full length manual reset linear limits
- Optional duplex receptacle section
- Wiring junction boxes on each end of the unit
- Custom colors and finishes available (consult factory)
- Limited by max Amp draw of 25 Amps (with no controls).
- Additional charges may be incurred if changes are made after production has begun - consult factory.

HOW TO DESIGNATE A MODEL:

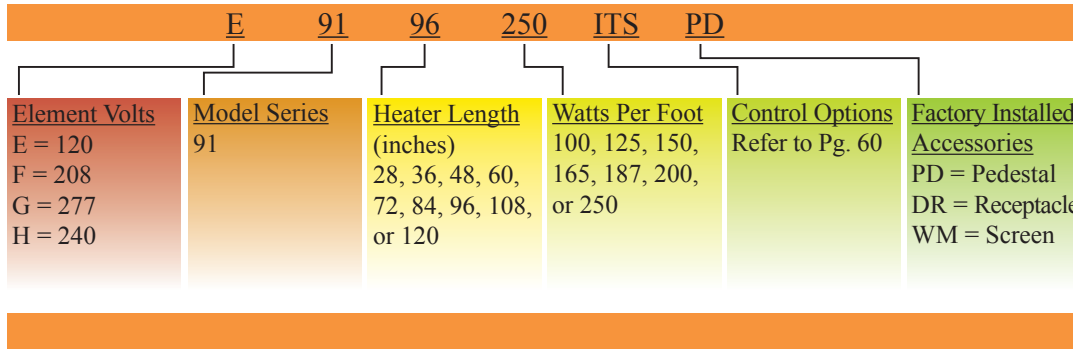

Product Description

TECHNICAL INFORMATION	
Air Intake	Bottom
Air Discharge	Top
Min Mounting Height	3"
Max Watts / Foot	250
Max Allowable Amps	25 Amps (20 Amps with disconnect)
Voltage / Phase	120V/208V/240V/277V Single Phase

TECHNICAL INFORMATION	
Height	4 1/2"
Depth	3 1/8"
Length	28" to 120" in 1' increments
Cabinet Material	Aluminum
Gauge	14
Optional Controls That Can Be Built Into Unit	Thermostat and Disconnect Switch (Control Section Required for Relays)

Standard Models

MODEL	UNIT LENGTH	LIST	FINISHED BACK ADDER
9128	28"	298	39
9136	36"	343	45
9148	48"	394	48
9160	60"	459	54
9172	72"	524	58
9184	84"	604	68
9196	96"	660	75
91108	108"	728	87
91120	120"	797	98

MODEL	UNIT LENGTH	LIST	FINISHED BACK ADDER
91BS012	12"	83	34
91BS024	24"	112	39
91BS036	36"	144	45
91BS048	48"	174	48
91BS060	60"	204	54
91BS072	72"	237	58
91BS084	84"	289	68
91BS096	96"	298	75
91BS108	108"	329	87
91BS120	120"	359	98

Factory Installed Accessories

SUFFIX	DESCRIPTION	LIST
DR	Duplex Receptacle in 4" Extended Enclosure (not available with 120" heater)	187
PD	28" through 60" - 2 Required	124
	72" through 96" - 3 Required	186
	108" through 120" - 4 Required	248
WM	1/4" wire mesh under grill	\$6.00 Per foot

Field Installed Accessories

MODEL	DESCRIPTION	LIST
9100IC	Inside Corner Section 90° or 135°	180
9100OC	Outside Corner Section 90° or 135°	
9100EC	Right or Left End Cap	61

Note: All models are suitable for International use
 Note: Extended enclosure per foot is 33 dollars.

CABINET

9100 Series shall be constructed of 14 gauge extruded 6063 Aluminum heat treated to T5 hardness. The uni-lock construction shall allow easy installation and access to back plate for wiring. The snap-fit front cover makes installation and service very simple. Custom factory enclosures to 1/16 inch increments are built for exact wall to wall fit up to 10 foot enclosure lengths. The 14 gauge back plate will have electrical knockouts for incoming power on each end adjacent to junction box. Pedestal mounted units will have incoming power connection through the pedestal on bottom of unit and will have smooth back for optional finished back. The die punched front cover will have no screw heads or fasteners.

ELEMENTS

High mass sheathed element construction with Nickel-Chromium resistance wire embedded in compacted efficient die-electric to ensure proper heat transfer. Aluminum fins mechanically bonded to stainless steel tube allows for increased surface area and even heat transfer.

LIMIT CONTROLS

Manual reset hydraulic thermal overload covers full length of heating element and shuts down heater when safe operating temperatures are exceeded.

WIRING

Wiring shall be in either end of the enclosure. Wiring can be in the junction box or optional control section if additional controls are needed. Pedestal mounted units shall have 1-1/4" hole through the pedestal and in the bottom of the enclosure for incoming power wiring. All heaters have a factory supplied built in raceway for wiring from either end of the heater or for wiring of continuous heater connections.

CONTROLS

Optional controls include single or double pole thermostat and disconnect switch that are factory wired in enclosed junction box on each end of heater enclosure. Relay, transformer relay and duplex receptacle options shall be mounted in extended length control section. **Control section will add to heater enclosure length.** The control section for the duplex receptacle will add 4" to enclosure length. The control section for other optional components or combinations of components will have two options (6" or 12") depending on controls required.

APPLICATION

The 9100 series is ETL listed for commercial, industrial or residential applications on all units up to 250 Watts per foot.

Product Dimensions

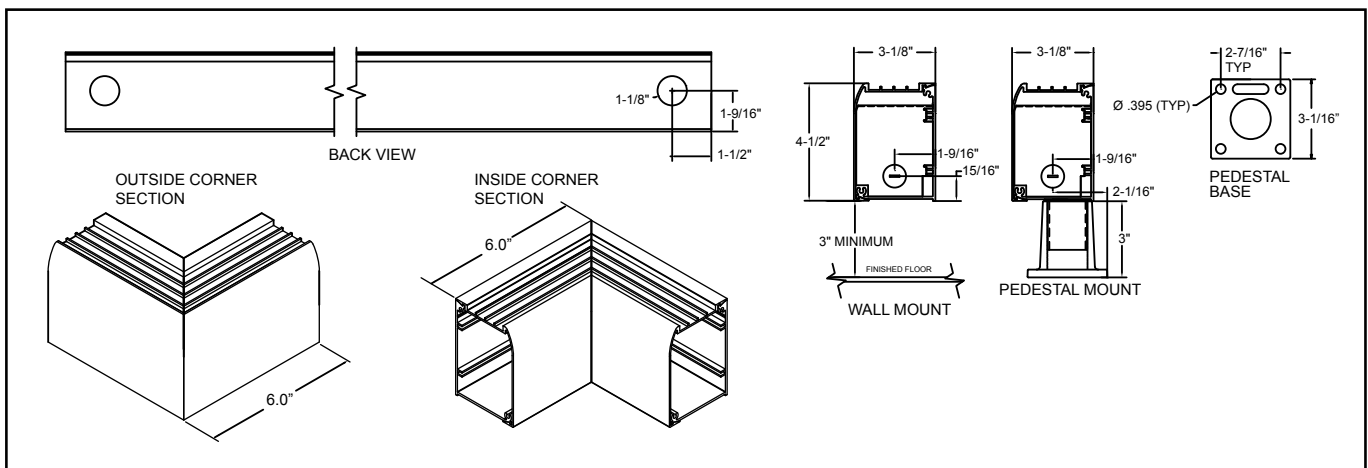

9300 Series - Radius Front Draft Barrier Heater

ETL listed up to 750 Watts / foot for industrial or commercial applications.



Manufactured in U.S.A.

Features

- Leed and green compliance, 1 and 3 phase applications
- Industrial or commercial applications
- Standard color: Bankers Bronze (powder coated)
- Also available in other standard TPI colors and custom colors for an additional charge
- Uni-lock construction for snap fit 2 piece installation
- Temperature control can be in-built or wall mounted
- Thermal protection by full length manual reset linear limits
- Optional accessories include: duplex receptacle, and inside or outside corner sections for wall to wall custom fit.
- Additional charges may be incurred if changes are made after production has begun - consult factory.

HOW TO DESIGNATE A MODEL:

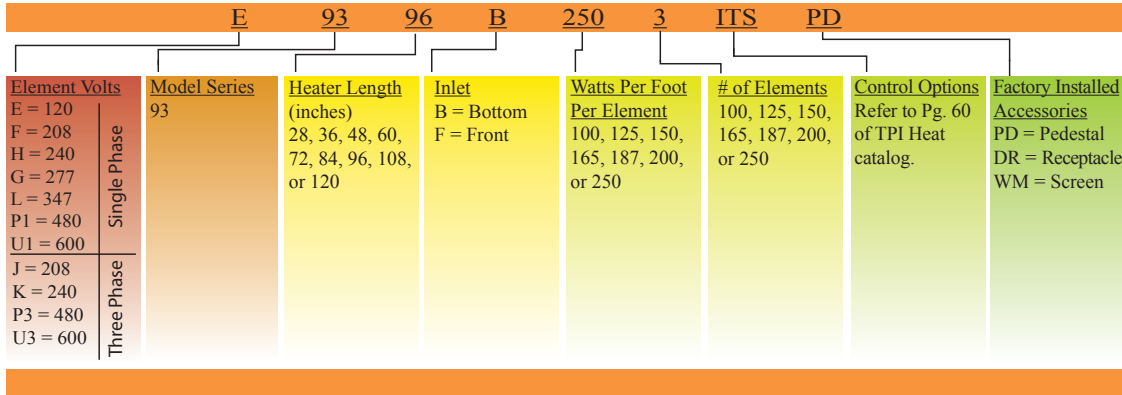

Note:

480V single phase units minimum 36" heated length; 600V single phase units minimum 48" heated length
347-480-600 single phase and all three phase units are built with low voltage option factory installed

Product Description

TECHNICAL INFORMATION	
Air Intake	Bottom / Front
Air Discharge	Top
Min Mounting Height	3" for bottom intake / 0" for front intake
Max Watts / Foot	750
Max Allowable Amps	25 without relay, 40 with relay
Voltage / Phase	120V/208V/240V/277V/347V,480V,600V Single Phase 208V,240V,480V,600V Three Phase

TECHNICAL INFORMATION	
Height	7.5"
Depth	6.15"
Length	28" to 120" in 1" increments
Cabinet Material	Aluminum
Material Gauge	12
Optional Controls That Can Be Built Into Unit	Thermostat, Disconnect Switch, Transformer (Control Section Required for Relays)

Standard Models

MODEL	UNIT LENGTH	LIST	FINISHED BACK ADDER
9328	28"	776	60
9336	36"	816	65
9348	48"	920	70
9360	60"	1022	75
9372	72"	1097	80
9384	84"	1173	85
9396	96"	1237	90
93108	108"	1298	95
93120	120"	1382	100

Factory Installed Accessories

SUFFIX	DESCRIPTION	LIST
DR	Duplex Receptacle in 4" Extended Enclosure (not available with 120" heater)	139
PD	28" through 60" - 2 Required	139
	72" through 96" - 3 Required	210
	108" through 120" - 4 Required	278
WM	1/4" wire mesh under grill	\$4.00 Per foot
IDS30	30 Amp/240V Disconnect Switch	95
IDS40	40 Amp/600V Disconnect Switch	95

Note: If using line voltage thermostat on 1 phase heaters, you cannot exceed 25 Amps due to Amp rating of thermostat. 347, 480, and 600V can use 30 Amps with in-built thermostat.

Field Installed Accessories

MODEL	DESCRIPTION	LIST
9300IC	Inside Corner Section 90° or 135°	223
9300OC	Outside Corner Section 90° or 135°	
9300EC	Right or Left End Cap	85

Note: All models are suitable for International use
Note: Extended enclosure per foot is 100 dollars.

CABINET

9300 Series shall be constructed of 12 gauge extruded 6063 Aluminum heat treated to T5 hardness. The uni-lock construction shall allow easy installation and access to back plate for wiring. The snap-fit front cover makes installation and service very simple. Custom factory enclosures to 1/16 inch increments are built for exact wall to wall fit up to 10 foot enclosure lengths. The 12 gauge back plate will have electrical knockouts for incoming power on each end adjacent to junction box. Pedestal mounted units will have incoming power connection through the pedestal on bottom of unit and will have smooth back for optional finished back. The die punched front cover will have no screw heads or fasteners.

ELEMENTS

High mass sheathed element construction with Nickel-Chromium resistance wire embedded in compacted efficient die-electric to ensure proper heat transfer. Aluminum fins mechanically bonded to stainless steel tube allows for increased surface area and even heat transfer.

LIMIT CONTROLS

Manual reset hydraulic thermal overload covers full length of heating element and shuts down heater when safe operating temperatures are exceeded.

WIRING

Wiring shall be in either end of the enclosure. Wiring can be in the junction box or optional control section if additional controls are needed. Pedestal mounted units shall have 1-1/4" hole through the pedestal and in the bottom of the enclosure for incoming power wiring. All heaters have a factory supplied built in raceway for wiring from either end of the heater or for wiring of continuous heater connections.

CONTROLS

Optional controls include single or double pole thermostat and disconnect switch that are factory wired in enclosed junction box on each end of heater enclosure. Relay, transformer relay and duplex receptacle options shall be mounted in extended length control section. **Control section will add to heater enclosure length.** The control section for the duplex receptacle will add 4" to enclosure length. The control section for other optional components or combinations of components will have two options (6" or 12") depending on controls required.

APPLICATION

The 9300 series is ETL listed for commercial or industrial applications on all units up to 750 Watts per foot on all units. 3 Phase units have a minimum of 300 Watts per foot.

Product Dimensions

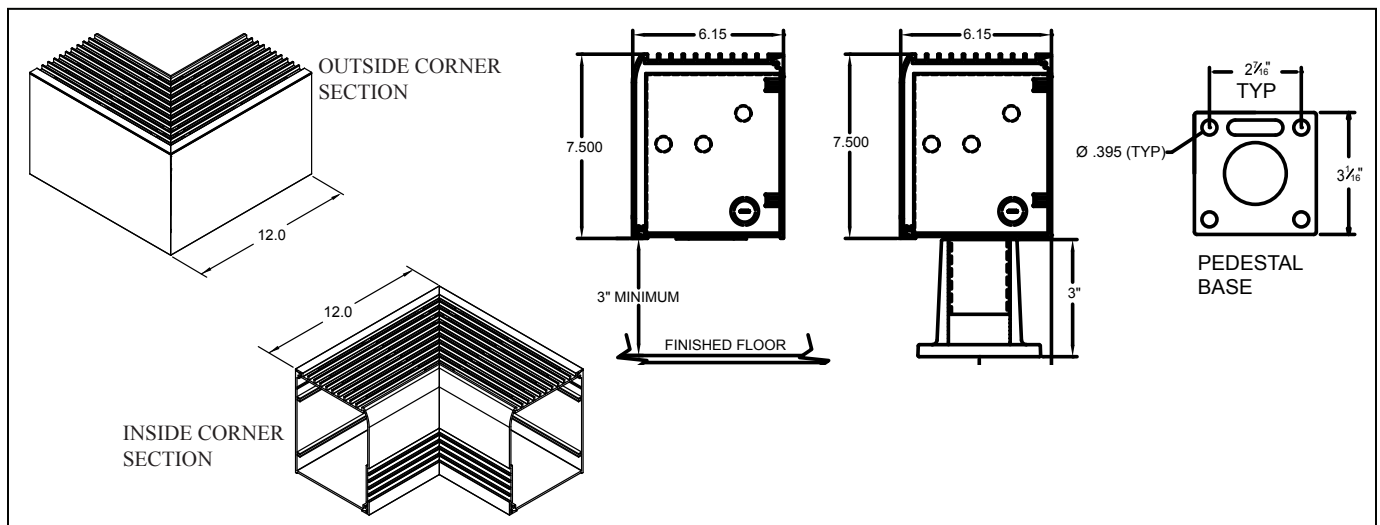

Draft Barrier Heaters - General Product Information

All Draft Barrier Heaters, unless otherwise noted, are build to order items. Consult factory for lead times. Additional charges may be incurred if changes are made after production has begun - consult factory.

Electric Draft Barrier Features

- “UNI-LOCK” construction allows snap-fit, 2 piece installation
- Heavy Gauge Aluminum Extruded enclosures, 6063 heat treated to T-5 hardness
 - a. DBT/DBF & RDBT-PD-12 gauge front & back
 - b. DBCT/DBCF- 10 gauge Front & Back
 - c. CB-14 gauge Front & Back
- ASHDB Series is 16 gauge Steel Front with 18 Steel gauge back
- 1/4” pencil proof discharge louvers
- Thermal protection by full length linear limits
- Multiple heaters, factory wired on same back plate, available in up to 10’ lengths
- Totally enclosed junction boxes
- Custom colors and finishes available (See Chart)
- Enclosures available for hydronic heating coils (consult factory for more information)

How To Designate A Model

Digit	(Example)	MODEL NUMBER DESIGNATION - “ASI” DRAFT BARRIER
Digit 1=	DBT	Series Model Number (DBT/DBF, CB, Etc.)
Digit 2=	PD	Use if Pedestals are Required* 2’ to 5’ Heaters require 2 pedestals 6’ to 8’ Heaters require 3 pedestals 9’ & 10’ Heaters require 4 pedestals
Digit 3=	4	Heated Length of Heater (for extended enclosure, specify amount of required enclosure on order write up, IE: 4’ Heated length w/ 2’6” of extended enclosure)
Digit 4=	250	Wattage per Linear foot (may not exceed allowable wattages on specific models, refer to catalogue page to verify maximum WPF)
Digit 5=	ITS (etc)	Control Options ; Refer to List Price chart for available options (Verify on each model which options may be factory installed)

Completed example: DBT-PD-4250-ITS

NOTE:

- Extended enclosures and Blank Sections are NOT punched. When a Control Section is specified, ALWAYS allow for an extended enclosure to compensate for the 6” or 12” length of the Section required.
- Note on order when finished backs are required and add list adder to model list.
- **Total heater amperage must not exceed the 25-Amp rating of the high temperature limit at any voltage or wattage. This applies to all Sill Line Model Series.**

Voltage & Wattage Specification

Voltage	Standard Wattages Per Foot	Heater Lengths
120-277	100, 125, 150, 165, 187, 200, 250*, 300, 333*, 375*	2’ through 10’

*Units with Extended Enclosures may require more Pedestals than standard length, must verify length of heater after extended enclosures for total amount of pedestals. NOTE: All bottom inlet units must be mounted a minimum of 3 inches above finished floor.

Dual element models DBCT/DBCF and ASHDB. All elements are single phase. Consult factory for more information.

Control Options

Suffix Designation	Description	List Adder
CS 6	6” control section / will contain up to 2 control options	48
CS 12	12” control section / will contain up to 3 control options	
ITS	Single Pole, 25 Amp integral thermostat, 120,208,240 & 277 Volts	70
ITD	Double Pole, 25 Amp integral thermostat, 120,208,240 & 277 Volts	76
IDS	Double Pole Disconnect, 20 Amp, 120, 208, 240 & 277 Volts	70
IDS 30	30 Amp disconnect (9300 Series)	95
IDS 40	40 Amp disconnect (9300 Series)	75
LVTR	Low voltage controls (trans & relay)	200
PR 120-277/24	Power Relay, 18 Amp tested, Must specify coil voltage Single Pole	95
PR 120-277/120		
PR 120-277/240		
ATR*	Single Pole, rated 25 Amps, 120 to 240 Volts, Contacts rated up to 277 Volts (must specify) Coils are 24 Volt; 24 Volt transformer	302

* Not suitable for International use

Note: Please refer to each model to verify how many controls may be integrally mounted, Control sections will add length to the heater. Must use control section with PR 240/24, PR 208/24, 208/208 and ATR

Note: If using line voltage thermostat on single phase heaters you cannot exceed 25 Amps due to Amp rating of thermostat. 347, 480, and 600V models can use up to 30 Amps with in-built thermostat.

CUSTOM PAINT COLORS

Durable Powder Coat Paint Finish

COLOR	SIZE	LIST
Bankers Bronze (Standard)		---
Eggshell White	Under 100 feet	96
Black		
Gray		
Beige		
Simulated Bronze or Clear Anodized		
Special Colors 5lb Increment - Consult Factory		

ANODIZING CHARGES 204R1 Clear 313R1 Bronze or Black	LIST ADDER
Under 100 feet	571
100 feet - 200 feet	390
Over 200 feet	---

DBF / DBT Series

DBCT / DBCF Series



Manufactured in U.S.A.



DBT Wall Mount
Model-300 WPF Max.



DBF Floor Mount
Model-250 WPF Max.

Cabinet Dimensions: 3-1/2" x 6" x 10' Maximum Length

Not suitable for residential applications. Built to order: consult factory for lead time.

MODEL	LENGTH	LIST					
		Clear Anodized		Color Anodized		Painted Bronze	
		Heater	Finished Back Adder	Heater	Finished Back Adder	Heater	Finished Back Adder
DBF-2/DBT-2	2'	404	103	434	129	334	40
DBF-3/DBT-3	3'	497	145	551	177	394	55
DBF-4/DBT-4	4'	603	182	651	227	462	50
DBF-5/DBT-5	5'	717	220	785	276	544	56
DBF-6/DBT-6	6'	868	259	902	325	664	62
DBF-7/DBT-7	7'	982	302	1007	380	741	74
DBF-8/DBT-8	8'	1095	342	1115	38	819	78
DBF-9/DBT-9	9'	1216	384	1354	484	906	90
DBF-10/DBT-10	10'	1278	430	1504	538	980	98
Extended Enclosure per foot		87		98		48	
Blank Section							
DBF/DBT-100BS	1'	141	76	156	100	103	36
DBF/DBT-200BS	2'	223	103	253	129	156	40
DBF/DBT-300BS	3'	302	145	353	177	204	47
DBF/DBT-400BS	4'	384	183	450	227	253	50
DBF/DBT-500BS	5'	469	220	551	276	302	56
DBF/DBT-600BS	6'	551	259	651	325	351	62
DBF/DBT-700BS	7'	638	302	753	380	408	74
DBF/DBT-800BS	8'	726	342	906	430	462	78
DBF/DBT-900BS	9'	814	384	961	484	515	90
DBF/DBT-1000BS	10'	849	910	1104	538	594	98

Accessories	Clear Anodized	Color Anodized	Painted Bronze
DESCRIPTION	LIST		
DBF/DBT IC / Inside Corner Section 90 - 180 Degrees	342	470	187
DBF/DBT OC / Outside Corner Section 180 - 270 Degrees - 6" longest side			
DBF/DBT ECR / Right Hand End Cap DBF/DBT ECL / Left Hand End Cap	70	70	64
DBF/DBT IECR / Inside Fitting Right End Cap DBF/DBT IECL / Inside Fitting Left End Cap	88	95	70
DBF/DBT WT / 2" - 6" Wall Trim	64	95	45
DBF/DBT SP / 1 1/2" Splice Plate			
DBF/DBT MF / Mullion Front up to 1'	90	100	75
DBF/DBT IF / Inside Filler up to 1'			
3/4" Conduit Raceway (standard is 1/2")	\$6.00 per foot		
Mesh / 1/4" Wire Mesh under Grill	\$7.00 per foot		
Pedestals - specify 2" or 3"	\$64.00 per Pedestal		
See Chart for required amount per Heater			

NOTE: DBF/DBT Series will permit a Thermostat mounted on one side and a Disconnect on the other side, more or other controls require a 6" or 12" control section. Typically, thermostats are mounted on left side of heater. Control Section will add to length of heater.



Manufactured in U.S.A.



DBCT Wall Mount
Model-750 WPF Max.



DBCF Floor Mount
Model-600 WPF Max.

Cabinet Dimensions: 5" x 7" x 10' Maximum Length

Not suitable for residential applications. Built to order: consult factory for lead time.

MODEL / LENGTH	WATTS/ FT.	LIST					
		Clear Anodized		Color Anodized		Painted Bronze	
		Heater	Finished Back Adder	Heater	Finished Back Adder	Heater	Finished Back Adder
DBCT-2/DBCF-2 2'	to 250 251-750	532 627	133	560 651	161	445 538	47
DBCT-3/DBCF-3 3'	to 250 251-750	555 768		189		715 811	
DBCT-4/DBCF-4 4'	to 250 251-750	808 744	240	849 973	283	631 750	68
DBCT-5/DBCF-5 5'	to 250 251-750	959 1081		300		1018 1136	
DBCT-6/DBCF-6 6'	to 250 251-750	1153 1292	353	1218 1355	420	888 1025	90
DBCT-7/DBCF-7 7'	to 250 251-750	1338 1461		404		1415 1537	
DBCT-8/DBCF-8 8'	to 250 251-750	1482 1613	466	1569 1701	549	1132 1259	109
DBCT-9/DBCF-9 9'	to 250 251-750	1648 1767		513		1743 1866	
DBCT-10/DBCF-10 10'	to 250 251-750	1766 1919	573	1919 2028	679	1369 1482	133
Extended Enclosure per foot		105		115		70	
Blank Sections							
DBCT/DBCF-100BS 1'		166	93	177	119	120	27
DBCT/DBCF-200BS 2'		302	132	319	162	211	47
DBCT/DBCF-300BS 3'		430	187	473	220	300	55
DBCT/DBCF-400BS 4'		562	204	603	283	387	67
DBCT/DBCF-500BS 5'		689	220	728	353	460	78
DBCT/DBCF-600BS 6'		823	259	854	420	560	90
DBCT/DBCF-700BS 7'		952	404	1038	484	647	98
DBCT/DBCF-800BS 8'		1085	468	1127	549	737	109
DBCT/DBCF-900BS 9'		1218	513	1259	642	823	120
DBCT/DBCF-1000BS 10'		1349	574	1393	679	911	132

Accessories	Clear Anodized	Color Anodized	Painted Bronze
DESCRIPTION	LIST		
DBCT/DBCF IC / Inside Corner Section 90 - 180 Degrees	429	587	249
DBCT/DBCF OC / Outside Corner Section 180 - 270 Degrees - 6" longest side			
DBCT/DBCF ECR / Right End Plate DBCT/DBCF ECL / Left End Plate	70	70	64
DBCT/DBCF IECR / Right End Plate (inside fit) DBCT/DBCF IECL / Left End plate (inside fit)	141	161	55
DBCT/DBCF WT / Wall Trim 2" - 6"	141	161	83
DBCT/DBCF SP / 1 1/2" Splice Plate			
DBCT/DBCF IF / Inside Filler (up to 1')	90	105	67
3/4" Conduit Raceway (standard is 1/2")	\$6.00 per foot		
Mesh / 1/4" Wire Mesh under Grill	\$7.00 per foot		
Pedestals - specify 2" or 3"	\$64.00 per Pedestal		
See Chart for required amount per Heater			

NOTE: DBCT/DBCF Series will permit a Thermostat mounted on one side and Disconnect on the other side, more or other controls require a 6" or 12" control section. Typically, Thermostats are mounted on left side of heater. Control Section will add to the length of heater.

DBTS Series Draft Barrier Heaters



Manufactured in U.S.A.

Features

- Bottom air intake.
- Maximum watts per foot: 300.
- Dimensions: Depth 2-5/8" x Height 4" Length 2' to 10'.
- 14 gauge Aluminum housing.
- Voltages: 120V / 208V / 240V / 277V - 1 Phase
- No controls can be added without adding a control section and extended enclosure.

Not suitable for residential applications. 300 watts per foot maximum. Built to order: consult factory for lead time.

Standard Models

MODEL		LENGTH	LIST					
			CLEAR ANODIZED		COLOR ANODIZED		PAINTED BRONZE	
			HEATER	FINISHED BACK ADDER	HEATER	FINISHED BACK ADDER	HEATER	FINISHED BACK ADDER
HEATER	DBTS-2	2'	380	105	414	129	314	40
	DBTS-3	3'	501	142	499	177	360	47
	DBTS-4	4'	547	183	589	227	414	50
	DBTS-5	5'	633	223	684	276	480	56
	DBTS-6	6'	769	259	836	325	549	62
	DBTS-7	7'	879	302	941	380	633	74
	DBTS-8	8'	951	342	1043	430	691	78
	DBTS-9	9'	1061	384	1157	484	762	91
	DBTS-10	10'	1162	430	1273	538	836	103
Extended Enclosure per foot			70		78		36	
BLANK SECTION	DBTS-100BS	1'	118	67	129	87	84	36
	DBTS-200BS	2'	183	105	211	129	117	40
	DBTS-300BS	3'	249	142	282	177	149	47
	DBTS-400BS	4'	314	183	355	227	183	50
	DBTS-500BS	5'	380	223	431	276	214	56
	DBTS-600BS	6'	443	259	510	325	249	62
	DBTS-700BS	7'	511	302	586	380	301	74
	DBTS-800BS	8'	571	342	679	430	314	78
	DBTS-900BS	9'	643	384	1098	484	346	91
DBTS-1000BS	10'	713	430	819	538	576	103	

Accessories

MODEL	DESCRIPTION	LIST		
		CLEAR ANODIZED	COLOR ANODIZED	PAINTED BRONZE
DBTS IC	Inside Corner Section 90° - 180°	342	473	187
DBTS OC	Outside Corner Section 180° - 270° - 6" longest side	342	473	187
DBTS ECR	Right Hand End Cap	70	70	64
DBTS ECL	Left Hand End Cap			
DBTS IECR	Inside Fitting Right End Cap	84	95	70
DBTS IECL	Inside Fitting Left End Cap			
DBTS WT	Wall Trim 2" - 6"	64	95	45
DBTS SP	Splice Plate 1 1/2"	64	95	45
DBTS MF	Mullion Front up to 1'	64	78	45
Note on order	1/2" Conduit Raceway	Standard		
	Mesh 1/4" Wire Mesh under grill	\$7.00 per foot		
	Pedestals - specify 2" or 3"	\$64.00 per Pedestal		

RDBT Series

ASHDB Series



Cabinet Dimensions: 7" x 6" x 10"
Maximum Length

Not suitable for residential applications. 300 Watts Per Foot Maximum. Pedestals included with unit. Rounded enclosure with flat top discharge. Special Build: consult factory for lead time.

Manufactured in U.S.A.

MODEL	LENGTH	LIST		
		Clear Anodized	Color Anodized	Painted Bronze
RDBT-PD-2	2'	750	819	557
RDBT-PD-3	3'	954	1045	658
RDBT-PD-4	4'	1174	1308	777
RDBT-PD-5	5'	1400	1567	905
RDBT-PD-6	6'	1633	1833	1045
RDBT-PD-7	7'	1868	2102	1181
RDBT-PD-8	8'	2103	2367	1317
RDBT-PD-9	9'	2340	2638	1452
RDBT-PD-10	10'	2577	2909	1611
Extended Enclosure per foot		167	193	87
Blank Sections				
RDBT-PD-100BS	1'	423	453	309
RDBT-PD-200BS	2'	566	721	408
RDBT-PD-300BS	3'	840	939	515
RDBT-PD-400BS	4'	1043	1220	620
RDBT-PD-500BS	5'	1257	1422	726
RDBT-PD-600BS	6'	1464	1584	833
RDBT-PD-700BS	7'	1673	1813	937
RDBT-PD-800BS	8'	1887	2048	1045
RDBT-PD-900BS	9'	2093	2276	1150
RDBT-PD-1000BS	10'	2304	2508	1276
Accessories		Clear Anodized	Color Anodized	Painted Bronze
Description				
RDBT-PDIC / Inside Corner Section 90 - 180 Degrees		66	75	54
RDBT-PDOC / Outside Corner Section 180 - 270 Degrees - 6" longest side				
RDBT-PDIECR/Inside Fitting Right End Cap		164	213	95
RDBT-PDIECL/Inside Fitting Left End Cap				
3/4" Conduit Raceway (standard is 1/2")		\$6.00 per Foot		
Mesh - 1/4" Wire Mesh under Grill		\$7.00 per Foot		

NOTE: RDBT-PD Series will permit a Thermostat mounted on one side and a Disconnect on the other side. More or other controls require a 6" or 12" control section. Typically, Thermostats are mounted on the left side of heater. Control Sections will add to length of heater.

CB Series



Manufactured in U.S.A.

Not suitable for residential applications. Bottom inlet only. Built to order: consult factory for lead time.

Cabinet Dimensions: 2-5/8" x 4-1/2" x 10"
Maximum Length

NOTE: CB Series will permit either a Thermostat or a Disconnect on only one side of the heater. More or other controls require a control section. Typically, Thermostats are mounted on the right side of heater. Control Sections will add to length of heater.

Model	Length	LIST					
		Clear Anodized		Color Anodized		Painted Bronze	
		Heater	Finished Back Adder	Heater	Finished Back Adder	Heater	Finished Back Adder
CB-2	2'	365	105	384	129	298	40
CB-3	3'	440	142	473	177	342	47
CB-4	4'	515	183	560	227	384	50
CB-5	5'	594	223	647	276	430	56
CB-6	6'	730	259	798	325	532	62
CB-7	7'	814	302	888	380	586	74
CB-8	8'	902	342	988	430	638	78
CB-9	9'	988	384	1088	493	691	91
CB-10	10'	1074	430	1186	538	748	103
Extended Enclosure per foot		64	74	30			
Blank Sections							
CB-100BS	1'	110	76	122	100	78	36
CB-200BS	2'	183	105	191	129	105	40
CB-300BS	3'	230	142	263	177	132	47
CB-400BS	4'	288	183	334	227	162	50
CB-500BS	5'	353	223	404	276	186	56
CB-600BS	6'	414	259	479	325	214	62
CB-700BS	7'	479	302	557	380	247	74
CB-800BS	8'	545	342	632	430	282	78
CB-900BS	9'	613	384	715	493	319	91
CB-1000BS	10'	684	430	798	538	328	103

Not suitable for residential applications. 500 Watts per foot maximum. 16 gauge Steel enclosure, 18 gauge backplate. Heights may vary from 8" up to 20." Bottom Intake / Top Discharge. Special build - consult factory for lead time.

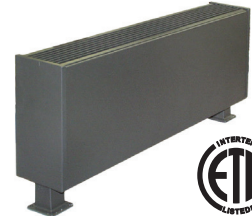

Cabinet Dimensions: 5-1/2" x 8" thru 20" x 10" Maximum Length.
Cannot be Anodized

Manufactured in U.S.A.

MODEL / LENGTH	WATTS / FT.	LIST						
		8-12" High		13-16" High		17-20" High		
		Heater	Finished Back Adder	Heater	Finished Back Adder	Heater	Finished Back Adder	
ASHDB-2	2'	to 250	466	48	511	74	593	95
		251-500	533		587		668	
ASHDB-3	3'	to 250	545	50	593	76	703	100
		251-500	538		668		538	
ASHDB-4	4'	to 250	615	55	676	80	809	105
		251-500	684		750		888	
ASHDB-5	5'	to 250	679	60	760	84	919	109
		251-500	758		836		999	
ASHDB-6	6'	to 250	798	67	865	91	1061	117
		251-500	870		943		1136	
ASHDB-7	7'	to 250	934	74	990	95	1213	120
		251-500	1008		1071		1292	
ASHDB-8	8'	to 250	1090	78	1146	103	1367	127
		251-500	1146		1225		1440	
ASHDB-9	9'	to 250	1211	83	1299	108	1519	132
		251-500	1283		1376		1594	
ASHDB-10	10'	to 250	1346	90	1452	115	1673	142
		251-500	1422		1531		1748	
Extended Enclosure per foot		51		65		78		
Blank Sections								
ASHDB-8/20-100BS	1'	143	43	174	64	183	74	
ASHDB-8/20-200BS	2'	194	48	228	67	276	77	
ASHDB-8/20-300BS	3'	253	50	283	83	356	80	
ASHDB-8/20-400BS	4'	278	55	346	76	440	86	
ASHDB-8/20-500BS	5'	330	60	404	78	521	90	
ASHDB-8/20-600BS	6'	393	56	466	110	603	98	
ASHDB-8/20-700BS	7'	462	74	511	90	708	103	
ASHDB-8/20-800BS	8'	504	78	569	95	792	110	
ASHDB-8/20-900BS	9'	562	83	642	100	885	115	
ASHDB-8/20-1000BS	10'	620	90	709	108	914	142	
Accessories		8-12" High	13-16" High	17-20" High				
Description					LIST			
ASHDB IC / Inside Corner Section 90 - 180 Degrees		305	320	336				
ASHDB OC / Outside Corner Section 180 - 270 Degrees - 6" longest side								
ASHDB ECR / Right End Cap		52	83	109				
ASHDB ECL / Left End Cap								
ASHDB SP / 1 1/2" Splice Plate								
ASHDB WT / 2" - 6" Wall Trim								
3/4" Conduit Raceway (standard is 1/2")		\$6.00 per Foot						
Mesh / 1/4" Wire Mesh under Grill		\$7.00 per Foot						
Pedestals - Specify 2" or 3"		\$64.00 per Pedestal						
See Chart for required amount per Heater								

NOTE: ASHDB Series will permit a Thermostat mounted on one side and a Disconnect on the other side, more or other controls require a 6" or 12" control section. Typically, Thermostats are mounted on left side of heater. Control Section will add to length of heater.

Accessories	Clear Anodized	Color Anodized	Painted Bronze
Description	LIST		
CB IC / Inside Corner Section 90 - 180 Degrees	342	473	187
CB OC / Outside Corner Section 180 - 270 Degrees - 6" longest side			
CB ECR / Right End Cap	70	70	64
CB ECL / Left End Cap			
CB WT / Wall Trim 2" - 6"	64	78	45
CB SP / Splice Plate 1 1/2"			
CB MF / Mullion Front up to 1'	64	86	45
1/2" Conduit Raceway			
Mesh / 1/4" Wire Mesh under Grill	\$7.00 per foot		
Pedestals - specify 2" or 3"	\$64.00 per Pedestal		
See Chart for required amount per Heater			

MR Series Heavy Duty Metal Sheath Electric Infrared Heater

Heavy Duty Overhead Infrared Heaters for Indoor Spot Heating, Zone or Total Area Heating Applications

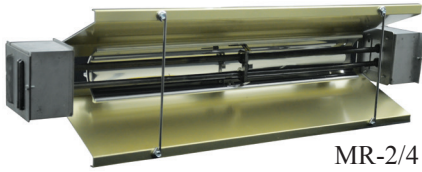

MR-2/4 KW

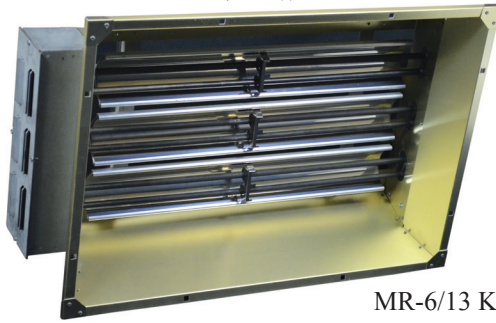

MR-6/13 KW



Manufactured in U.S.A.

- High-Density radiant heat, with 60° symmetric heat pattern.
- ETL Listed for suspended high-bay indoor applications
- Rugged straight metal sheath elements installed, great for high vibration areas.
- Gold anodized Aluminum housing for efficient, long term reflectivity & corrosion resistance.
- Terminal box with high-temp Silicone wire.
- Single or three phase wiring.
- "L" brackets included for chain suspension, or rigid mounting.

MR Series Safety Note

Ground fault protection must be used. To avoid potential hazards use model GF-SK-1 ground fault sensing switch with these heaters. This device is designed to provide a reliable way to quickly terminate power to the heaters in the event of a ground fault occurrence.

Standard Models

UPC# 686334	MODEL	KW	BTU'S	VOLTS	PHASE	AMPS		WT. (Lbs.)	LIST	Optional Wireguards		
						3-Ph	1-Ph			UPC# 686334	MODEL	LIST
135177	MR-212-1	1.8*	6,143	120	1	N/A	15.0	9.0	410	449090	HDWG-2	57
135184	MR-220-1	2.0	6,826	208	1		9.6					
135214	MR-224-1			240			8.5					
135221	MR-227-1			277			7.2					
135238	MR-248-1			480			4.2					
135245	MR-257-1			600			3.3					
135306	MR-420-1			4.5		15,359	208	1	21.6	15.0	519	449069
135320	MR-424-1	240	18.8									
135337	MR-427-1	277	16.3									
135344	MR-448-1	480	9.5									
135351	MR-457-1	600	7.5									
135368	MR-620-3	6.0	20,478		208		3 or 1		17.0			
135375	MR-624-3			240	14.5	25.0						
135382	MR-627-3			277	N/A	21.7						
135412	MR-648-3			480	7.5	13.0						
135429	MR-657-3			600	5.8	10.0						
135115	MR-1320-3			13.5	46,076	208		3	37.5	43.0	1261	449083
135122	MR-1324-3	240	33.0			N/A						
135139	MR-1327-3	277	N/A			48.8						
135153	MR-1348-3	480	3 or 1			17.0	29.0					
135160	MR-1357-3	600				13.6	N/A					
135252	MR-2720-3	208				74.8						
135269	MR-2724-3	240	64.8	288.0 Crated	2715	883047		HDWG-27	307			
135283	MR-2748-3	480	32.4									
135290	MR-2757-3	600	26.7									

Note: Some 3-Phase models can be field converted to single phase operation.

Heavy Duty Metal Sheath Infrared Control Options

CONTROL FEATURES:

- (GF-SK-1) Positive "off" and built-in "on/off" rocker switch illuminates "red" during operation.
- Controls cannot be mounted directly on unit. Must use 6" minimum threaded conduit.

UPC 686334	MODEL	DESCRIPTION	RATING (VAC)	Dimensions (In)			WT. (lbs.)	LIST
				Ht.	Wd.	Dp.		
486026	GF-SK-1	Ground Fault Sensing Switch	208V - 600V 50A	10.3	10.3	5.0	12	737
589376	DC-SK-1	Disconnect Switch	120V - 600V 50A	5.0	6.0	4.0	5	360

MR Series Heavy Duty Metal Sheath Electric Infrared Heater

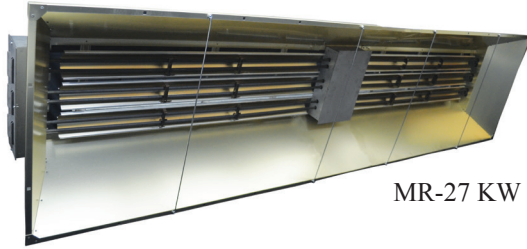

MR-27 KW

Note: The MR-27 Series includes (2) Terminal Box Assemblies, located on each end of the heater, requiring an electrical service to each end.



Manufactured in U.S.A.

MR Series Dimensions & Reflector Pattern

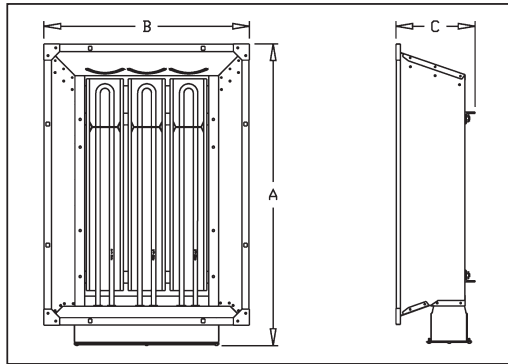

SERIES	DIMENSIONS (in.)		
	A LENGTH	B WIDTH	C DEPTH
MR-2	28	9	7.25
MR-4	48.5	9	7.25
MR-6	30	19.88	7.5
MR-13	50.5	19.88	7.5
MR-27	96.75	28.25	14.88

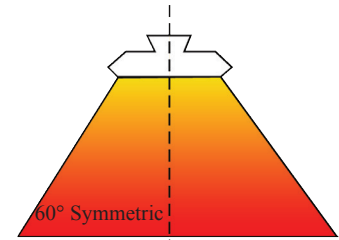

NOTE: Take into account that the MR Series is designed with a 60° symmetrical reflector heat pattern. The sizing chart can assist you based upon your mounting height.

Mounting Clearances & Recommended Mounting Height

Mounting Clearances		Recommended Mounting Height	
All MR Models	24" from ceiling 36" from vertical surface & from another heater 72" from face of heater to combustible surface	1.8 & 2.0 KW	8' - 10'
		4.5 KW	8' - 12'
		6.0 KW	10' - 14'
		13.5 KW	12' - 16'
MR-27 Only	87" from face of heater to combustible surface	27.0 KW	15' - 30'

Sizing Chart

Mounting Height	Heater Model	Length	Wide	Coverage (Sq. Ft.)	Watts / Sq. Ft.
8'	MR-2	8	8	64	31.3
	MR-4	9	8	72	62.5
10'	MR-2	11	10	110	18.2
	MR-4	11	10	110	40.9
	MR-6	12	10	120	50.0
12'	MR-4	12	11.5	138	32.6
	MR-6	14	12	168	35.7
	MR-13	15	13	195	69.2
14'	MR-6	16	14	224	26.8
	MR-13	18	16	288	46.9
16'	MR-6	18	16	288	20.8
	MR-13	21	18	378	35.7
	MR-27	24	19	456	59.2
18'	MR-13	23	20	460	29.3
	MR-27	28	20	560	48.2
20'	MR-27	28	23	644	41.9
24'	MR-27	33	27	891	30.3
30'	MR-27	41	32	1312	20.6

Product Specifications

Housing:

.040 Gold anodized Aluminum housing for efficient, long-term reflectivity and corrosion resistance. High-density radiant heat. Housing is ETL Listed for indoor, dry environment applications only.

Reflector:

60 degree symmetric heat pattern.

Elements:

Rugged straight metal sheath elements. .430" diameter Incoloy 840 metal sheath. Nickel-Chrome alloy coiled filament imbedded within a Magnesium Oxide insulating powder and threaded end terminations. Available wattages in 1800, 2000, and 4500 Watts per element. Available in standard voltages from 120 to 600 Volts.

Controls:

Heavy Duty, Metal Sheath heaters are not manufactured with any control device on the unit. All controls and accessories should be specified as remote mounted. Please consult the technical sales department of factory for help in determining applicable controls. Please follow installation instructions that accompany each heater.

Accessories:

Wire guards and power contactor panels.

TH & THSS Series Mul-T-Mount Electric Infrared Heater

Overhead Infrared Heaters for Snow & Ice Control, Outdoor Spot Heating & All Indoor Heating Applications



Product Description

AVAILABLE IN 2 LAMP BROWN ENAMEL OR STAINLESS STEEL, OR 3 LAMP STAINLESS STEEL.

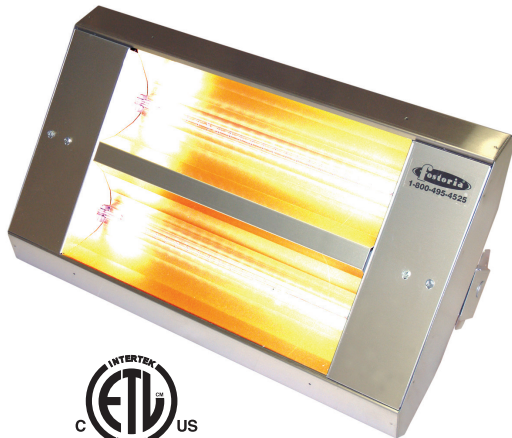

Manufactured in U.S.A.

- Listed for suspended, totally exposed (outdoor), high-bay (indoor) comfort heating and exterior snow & ice control applications.
- Listed for recessed applications.
- 20 gauge painted steel or stainless steel housings.
- Gold anodized Aluminum reflectors & end caps.
- 50% higher Watt densities for 3-element units.
- 2-Lamp wiring, single phase.
- 3-Lamp wiring, three or single phase.
- Stainless steel models have non-corrosive housing, hardware and brackets; no ferrous metals used in the unit. Durable in harsh atmospheres & outdoor environments.
- High temperature lead wires.
- Clear Quartz Lamp(s) Included.

New Feature:

In-Built surface mounting brackets allows for fixture adjustment up to 45° horizontal tilt.

In-built surface mounting brackets attached to the top wiring channel.

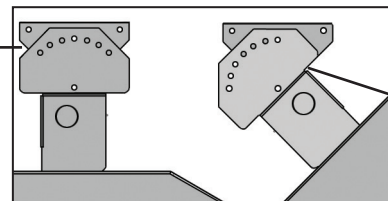

0 to 45° tilt @ 15° increments

Product Dimensions

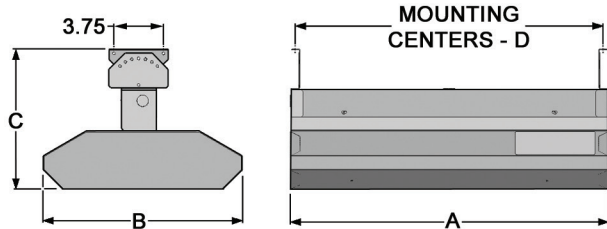

Mul-T-Mount Series	Dimensions (in.)			
	A Length	B Width	C Height	D Mtg. Ctr.
222	24"	15"	10-7/8"	23-1/2"
342	33"	15"	10-7/8"	32-1/2"
462	46"	15"	10-7/8"	45-1/2"
223	24"	21-1/2"	10-7/8"	23-1/2"
343	33"	21-1/2"	10-7/8"	34"
463	46"	21-1/2"	10-7/8"	45-1/2"

Mounting Clearances & Recommended Mounting Height

Mounting Clearances		Recommended Mounting Height	
2 & 3 Lamp Models	3" from ceiling	30° Symmetric & A30° Asymmetric Reflector - Indoor	14' - 30'
	24" from vertical surface	60° Symmetric & A60° Asymmetric Reflector - Indoor	12' - 18'
2 Lamp Models	72" from face of heater to combustible surface	90° Symmetric Reflector - Indoor	8' - 12'
3 Lamp Models	96" from face of heater to combustible surface	30° Symmetric & A30° Asymmetric Reflector - Outdoor	8' - 10'

Reflector Patterns

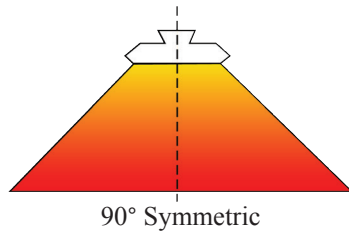
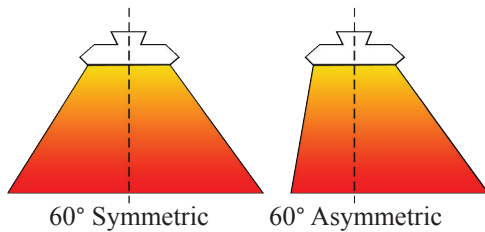
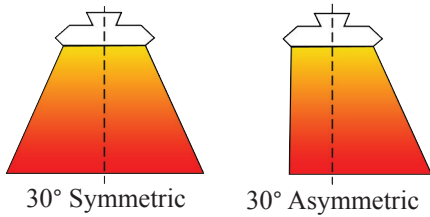

Product Specifications

Series:

- 222, 342, 462 (Painted Version) 2-lamp
- 222, 342, 462 (Stainless Steel Version) 2-lamp
- 223, 343, 463 (Stainless Steel Version) 3-lamp

Housing:

20 gauge Galvanized Steel with a baked on, brown enamel (painted) finish. Housing is ETL Listed for both indoor and totally exposed outdoor applications.

20 gauge Stainless Steel for durability and corrosion-resistance. Housing is ETL Listed for both indoor and totally exposed outdoor applications.

Reflectors and End Caps:

.040 Gold anodized Aluminum reflectors and end caps for superior reflectivity. Five choices of reflector patterns including 30 degree narrow (symmetric & asymmetric), 60 degree medium (symmetric & asymmetric), and 90 degree wide (symmetric).

Elements:

Clear quartz lamps. Coiled tungsten filament located within a sealed quartz envelope, halogen filled, with porcelain end caps and 6" wire pigtail leads. 96% radiant delivered efficiency with high moisture and thermal shock resistance. Instantaneous heat-up and cool-down performance. Available wattages from 500 to 3800 Watts per element. Available voltages from 120 to 600 Volts.

Controls:

Mul-T-Mount heaters are not manufactured with any control device on the unit. All controls are accessories and should be specified as such. Please consult the technical sales department of factory for help in determining applicable controls. Please follow installation instructions that accompany each heater.

Accessories:

Recessed mounting frames (painted or stainless steel), adjustable mounting brackets (stainless steel only), vertical mounting brackets (stainless steel only), wire guards, thermostats, snow detectors, SCR controllers, and power contactor panels.

Sizing Chart

Reflective Pattern (°)	Heater Output (kW)	# of Qiz. Lamps	Mounting Heights (FT.)							Watts Delivered per Square Foot							
			8	10	12	14	16	18	20	Mounting Heights (FT.)							
			Heat Pattern Coverage @ Floor Level														
			L x W	L x W	L x W	L x W	L x W	L x W	L x W	8	10	12	14	16	18	20	
30°	3.2	2 - Quartz Lamp Heaters	5.5 x 4	6.5 x 5.5	7.5 x 6.5	8.5 x 7.5	9.5 x 8.5	10.5 x 9.5	11.5 x 10.5	145.5	89.5	65.6	50.2	39.6	32.1	26.5	
			10.5 x 9.5	13 x 12	15 x 14	17 x 16	N/R	N/R	N/R	32.1	20.5	15.2	11.8	-	-	-	
			17 x 16	21 x 20	N/R	N/R	N/R	N/R	N/R	11.8	7.6	-	-	-	-	-	
	5.0		6	6 x 4	7.5 x 5.5	8.5 x 6.5	9.5 x 7.5	10.5 x 8.5	11.5 x 9.5	12.5 x 10.5	208.3	121.2	90.5	70.2	56.0	45.8	38.1
				11.5 x 9.5	14 x 12	16 x 14	18 x 16	20.5 x 18.5	23 x 21	N/R	45.8	29.8	22.3	17.4	13.2	10.4	-
				18 x 16	22 x 20	26 x 24	N/R	N/R	N/R	N/R	17.4	11.4	8.0	-	-	-	-
	7.3		N/R	8.5 x 5.5	9.5 x 6.5	10.5 x 7.5	11.5 x 8.5	12.5 x 9.5	13.5 x 10.5	-	156.1	118.2	92.7	74.7	61.5	51.5	
				12 x 10.5	15 x 12	17 x 14	19 x 16	21.5 x 18.5	24 x 21	N/R	57.9	40.6	30.7	24.0	18.4	14.5	-
				19 x 16	23 x 20	27 x 24	N/R	N/R	N/R	N/R	24.0	15.9	11.3	-	-	-	-
60°	4.8	3 - Quartz Lamp Heaters	5.5 x 5	6.5 x 6.5	7.5 x 7.5	8.5 x 8.5	9.5 x 9.5	10.5 x 10.5	11.5 x 11.5	174.5	113.6	85.3	66.4	53.2	43.5	36.3	
			10.5 x 10.5	13 x 13	15 x 15	17 x 17	21 x 21	N/R	N/R	43.5	28.4	21.3	16.6	10.9	-	-	
			17 x 17	21 x 21	N/R	N/R	N/R	N/R	N/R	16.6	10.9	-	-	-	-	-	
	7.5		N/R	7.5 x 6.5	8.5 x 7.5	9.5 x 8.5	10.5 x 9.5	11.5 x 10.5	12.5 x 11.5	-	153.8	117.6	92.9	75.2	62.1	52.2	
				11.5 x 10.5	14 x 13	16 x 15	18 x 17	20.5 x 19.5	23 x 22	N/R	62.1	41.2	31.3	24.5	18.8	14.8	-
				18 x 17	22 x 21	26 x 25	N/R	N/R	N/R	N/R	24.5	16.2	11.5	-	-	-	-
	10.95		N/R	8.5 x 6.5	9.5 x 7.5	10.5 x 8.5	11.5 x 9.5	12.5 x 10.5	13.5 x 11.5	-	198.2	153.7	122.7	100.2	83.4	70.5	
				12 x 11	15 x 13	17 x 15	19 x 17	21.5 x 19.5	24 x 22	N/R	83.0	56.2	42.9	33.9	26.1	20.7	-
				19 x 17	23 x 21	27 x 25	N/R	N/R	N/R	N/R	33.9	22.7	16.2	-	-	-	-

TH & THSS Series Mul-T-Mount Electric Infrared Heater



2 Lamp Mul-T-Mount Series Brown Enamel Or Stainless Steel With 2 Clear Quartz Lamps Included

BROWN HOUSING		STAINLESS STEEL HOUSING		KW	BTU'S	VOLTS	REFLECTOR PATTERN	Replacement Element	WT. (Lbs.)	LIST	
UPC# 686334	MODEL	UPC# 686334	MODEL							Brown	Stainless Steel
444163	222-30-TH-208V	444408	222-30-THSS-208V	3.2	10,922	208	30° Symmetrical	63016209	20	631	762
444170	222-30-TH-240V	444415	222-30-THSS-240V			240		63016249			
444187	222-30-TH-277V	444422	222-30-THSS-277V			277		63016279			
481380	222-30-TH-480V	481434	222-30-THSS-480V			480		63016489			
444194	222-A30-TH-208V	444439	222-A30-THSS-208V			208	30° Asymmetrical	63016209			
444200	222-A30-TH-240V	444446	222-A30-THSS-240V			240		63016249			
444217	222-A30-TH-277V	444453	222-A30-THSS-277V			277		63016279			
481410	222-A30-TH-480V	481465	222-A30-THSS-480V			480	63016489				
444224	222-60-TH-208V	444460	222-60-THSS-208V			208	60° Symmetrical	63016209			
444231	222-60-TH-240V	444477	222-60-THSS-240V			240		63016249			
444248	222-60-TH-277V	444484	222-60-THSS-277V			277		63016279			
481397	222-60-TH-480V	481441	222-60-THSS-480V			480	63016489				
444255	222-A60-TH-208V	444491	222-A60-THSS-208V			208	60° Asymmetrical	63016209			
444262	222-A60-TH-240V	444507	222-A60-THSS-240V			240		63016249			
444279	222-A60-TH-277V	444514	222-A60-THSS-277V			277		63016279			
481427	222-A60-TH-480V	481472	222-A60-THSS-480V			480	63016489				
443296	222-90-TH-208V	444521	222-90-THSS-208V	208	90° Symmetrical	63016209					
444286	222-90-TH-240V	444538	222-90-THSS-240V	240		63016249					
444293	222-90-TH-277V	444545	222-90-THSS-277V	277		63016279					
481403	222-90-TH-480V	481458	222-90-THSS-480V	480	63016489						
481083	342-30-TH-208V	480932	342-30-THSS-208V	5.0	17,065	208	30° Symmetrical	63025209	25	832	1066
481090	342-30-TH-240V	480949	342-30-THSS-240V			240		63025249			
802611	342-30-TH-480V	802635	342-30-THSS-480V			480	63025489				
481175	342-A30-TH-208V	481021	342-A30-THSS-208V			208	30° Asymmetrical	63025209			
481182	342-A30-TH-240V	481038	342-A30-THSS-240V			240		63025249			
444316	342-A30-TH-480V	444569	342-A30-THSS-480V			480	63025489				
481113	342-60-TH-208V	480963	342-60-THSS-208V			208	60° Symmetrical	63025209			
481120	342-60-TH-240V	480970	342-60-THSS-240V			240		63025249			
802918	342-60-TH-480V	802932	342-60-THSS-480V			480		63025489			
481205	342-A60-TH-208V	481052	342-A60-THSS-208V			208	60° Asymmetrical	63025209			
481212	342-A60-TH-240V	481069	342-A60-THSS-240V			240		63025249			
444330	342-A60-TH-480V	444583	342-A60-THSS-480V			480	63025489				
481144	342-90-TH-208V	480994	342-90-THSS-208V			208	90° Symmetrical	63025209			
481151	342-90-TH-240V	481007	342-90-THSS-240V			240		63025249			
803212	342-90-TH-480V	803236	342-90-THSS-480V			480		63025489			
802710	462-30-TH-480V	802734	462-30-THSS-480V			7.3	24,915	480			
444361	462-A30-TH-480V	444613	462-A30-THSS-480V	30° Asymmetrical	63036489						
803014	462-60-TH-480V	803038	462-60-THSS-480V	60° Symmetrical	63036489						
444385	462-A60-TH-480V	444637	462-A60-THSS-480V	60° Asymmetrical	63036489						
803311	462-90-TH-480V	803335	462-90-THSS-480V	90° Symmetrical	63036489						

NOTE: Consult the factory, the product instruction manual, or a licensed electrician for 3-phase wiring of all 2-element heaters.

TH & THSS Series Mul-T-Mount Electric Infrared Heater

3 Lamp Mul-T-Mount Series

Brown Enamel Or Stainless Steel Housing With 3 Clear Quartz Lamps Included



Manufactured in U.S.A.

NOTE:

- 600-Volt Models also available, contact factory for more information.
- Asymmetrical pattern units are also available for 30° & 60°

BROWN HOUSING		STAINLESS STEEL HOUSING		KW	BTU'S	VOLTS	REFLECTOR PATTERN	Replacement Element	WT. (LBS.)	LIST	
UPC# 686334	MODEL	UPC# 686334	MODEL							Brown	Stainless Steel
487481	223-30-TH-208V	443678	223-30-THSS-208V	4.8	16382	208	30° Symmetrical	63016209	25	1032	1163
487498	223-30-TH-240V	443685	223-30-THSS-240V					63016249			
487504	223-30-TH-277V	443692	223-30-THSS-277V					63016279			
487511	223-30-TH-480V	481588	223-30-THSS-480V			63016489					
487528	223-60-TH-208V	443289	223-60-THSS-208V			63016209					
487535	223-60-TH-240V	443739	223-60-THSS-240V			63016249					
487542	223-60-TH-277V	443746	223-60-THSS-277V			63016279					
487559	223-60-TH-480V	481595	223-60-THSS-480V			63016489					
487566	223-90-TH-208V	443784	223-90-THSS-208V			63016209					
487573	223-90-TH-240V	443791	223-90-THSS-240V			63016249					
487580	223-90-TH-277V	443807	223-90-THSS-277V			63016279					
487597	223-90-TH-480V	481601	223-90-THSS-480V			63016489					
487603	343-30-TH-208V	481236	343-30-THSS-208V	7.5	25298	208	30° Symmetrical	63025209	33	1248	1482
487610	343-30-TH-240V	481243	343-30-THSS-240V					63025249			
487627	343-30-TH-480V	811439	343-30-THSS-480V					63025489			
487634	343-60-TH-208V	481267	343-60-THSS-208V			63025209					
487641	343-60-TH-240V	481274	343-60-THSS-240V			63025249					
487658	343-60-TH-480V	811637	343-60-THSS-480V			63025489					
487665	343-90-TH-208V	481298	343-90-THSS-208V			63025209					
487672	343-90-TH-240V	481304	343-90-THSS-240V			63025249					
487689	343-90-TH-480V	811835	343-90-THSS-480V			63025489					
487696	463-30-TH-480V	810531	463-30-THSS-480V			10.95	37372	480			
487702	463-60-TH-480V	810739	463-60-THSS-480V	60° Sym.	63036489						
487719	463-90-TH-480V	810937	463-90-THSS-480V	90° Sym.	63036489						

TH & THSS Series Product Accessories

UPC# 686334	MODEL	DESCRIPTION	FOR USE WITH	WT. (LBS.)	LIST
881128	VMB-41-SS	Wall Mounting Brackets (2)	All Mul-T-Mount Models	12	208
851152	CHWG-222	Stainless Steel Wire Guards	222 Series	2	56
851145	CHWG-342		342 Series		74
851626	CHWG-462		462 Series		101
854368	CHWG-223		223 Series		69
854351	CHWG-343		343 Series		90
854344	CHWG-463		463 Series		105
Recessed Mounting Frames (UL)					
		Ceiling Cutout (in.)	Frame Size (in.)		
441995	RMF-222-SS-A	27 x 17-7/8	29-1/8 x 20	6	230
449441	RMF-222-A	27 x 17-7/8	29-1/8 x 20		168
442077	RMF-342-SS-A	36 x 17-7/8	38-1/8 x 20	9	285
441872	RMF-342-A	36 x 17-7/8	38-1/8 x 20		169
442107	RMF-462-SS-A	49 x 17-7/8	51-1/8 x 20	11	349
449458	RMF-462-A	49 x 17-7/8	51-1/8 x 20		215
881104	RMF-223-SS	32 x 29-3/8	34-1/8 x 31-1/2	15	349
881135	RMF-343-SS	41 x 29-3/8	43-1/8 x 31-1/2	18	410
881111	RMF-463-SS	54 x 29-3/8	56-1/8 x 31-1/2	20	500
487726	RMF-223	32 x 29-3/8	34-1/8 x 31-1/2	15	280
487733	RMF-343	41 x 29-3/8	43-1/8 x 31-1/2	18	294
487740	RMF-463	54 x 29-3/8	56-1/8 x 31-1/2	20	366
440783	31939009	Red Vycor Sleeves	All 1600W Qtz. Lamp	2	85
440738	31940009	Reduces Quartz Lamp Brightness by 90%	All 2500W Qtz. Lamp		112
440745	31941009		All 3650W Qtz. Lamp		138
446150	632-1620	Red Quartz Lamps: 1.6kw. 208v	222,223 & RPH Series	2	144
446167	632-1624	Red Quartz Lamps: 1.6kw. 240v			144
446228	632-2548	Red Quartz Lamps: 2.5kw. 480v			342 & 343 Series

OCH Series Outdoor / Indoor Rated Quartz Electric Infrared Heater

Features

Heats solid objects, not the air!



Manufactured in U.S.A.

- Frosted Quartz Tube heating element (included)
- Listed for suspended, totally exposed (outdoor) and indoor spot heating applications
- Finish: High-temp brown powder coated finish or corrosion resistant stainless steel 24 gauge housing
- 60° Symmetric Heat Pattern
- Gold anodized Aluminum reflector and end caps
- Painted models are direct wire, unless specified and are supplied with 6" lead wires for field connection in the internal wiring compartment. These models are available with a factory installed 6' cord set. The 208V model must have a field supplied plug.
- Stainless steel models include an electrical enclosure assembled to the end of the heater housing and (2) 6" long lead wires for direct field connection.
- Two 2' ft. long mounting chains and four S-Hooks included
- The OCH-Series can be surfaced mounted using the supplied mounting brackets which allow up to a 45° horizontal tilt adjustment.

Product Models

FINISH - BROWN			FINISH - STAINLESS STEEL			CONNECTION TYPE	WATTS	BTU'S	VOLTS	AMPS	Qtz. Tube Repl. Element	WT. (LBS.)	
UPC# 686334	MODEL	LIST	UPC# 686334	MODEL	LIST								
Includes Electrical Enclosure						Hard Wire	1500	5120	120	12.5	671-3784	10	
480444	OCH-46-120VE	315	480529	OCH-46-120V-SSE	370								
480451	OCH-46-208VE		480536	OCH-46-208V-SSE									
480468	OCH-46-240VE		480543	OCH-46-240V-SSE									
480475	OCH-46-277VE		480550	OCH-46-277V-SSE									
480499	OCH-57-208VE	360	480574	OCH-57-208V-SSE	410		3000	10239	208	14.4	671-5060	12	
480482	OCH-57-240VE		480567	OCH-57-240V-SSE			3000	10239	240	12.5	671-3786		
480505	OCH-57-277VE		480581	OCH-57-277V-SSE			3000	10239	277	10.8	671-5059		
480512	OCH-57-480VE		480598	OCH-57-480V-SSE			2250	7679	480	4.7	671-5058		
485975	OCH-46-120VCE	340	---	---	---		Corded	1500	5120	120	12.5	671-3784	11
485982	OCH-57-208VCE	400	---	---	---			2000	6826	208	9.6	671-5061	13
485999	OCH-57-240VCE		---	---	---			2000	6826	240	8.3	671-3785	

Product Accessories

UPC # 686334	MODEL	DESCRIPTION	FOR USE WITH	WT. (LBS.)	LIST
480888	OCHWG-46	Stainless Steel Wire Guards	OCH-46 Series Models	2	56
480895	OCHWG-57		OCH-57 Series Models	2	59
881128	VMB-41-SS	Wall Mtg. Brackets (2)	ALL OCH Models	12	208
445948	VHC-15	Variable Heat Controller	208/240V OCH Models Only	3	162
485357	VHC-32	Variable Heat Controller	208/240V OCH Models Only	3	422

OCH Sizing Chart

Mounting Height	Heater Model	Watts	Heat Pattern Coverage (at floor level)			Total Watts / Sq. Ft.
			Length	Width	Sq. Ft.	
7'	OCH-46	1500	11	9	99	15.2
	OCH-46	2000	11	9	99	20.2
8'	OCH-46	1500	12	10	120	12.5
	OCH-46	2000	12	10	120	16.7
	OCH-57	3000	13	10	130	23.1
	OCH-57	2250	13	10	130	17.3
9'	OCH-46	1500	13	11	143	10.5
	OCH-46	2000	13	11	143	14.0
	OCH-57	3000	14	11	154	19.5
	OCH-57	2250	14	11	154	14.6
10'	OCH-57	3000	15	12	180	16.7
	OCH-57	2250	15	12	180	12.5
12'	OCH-57	3000	17	14	238	12.6
	OCH-57	2250	17	14	238	9.5

Product Specifications

Series:
OCH-46 & OCH-57

Housing:
24 gauge Aluminized Steel with a baked on brown powder coat finish. Housing is cETLus Listed for indoor or outdoor applications. Horizontal mounting only.

Reflectors and End Caps:
.040 Gold anodized Aluminum reflectors and end caps for superior reflectiveness. 60 degree medium (symmetric) pattern only.

Elements:
Quartz Tubes. Frosted quartz envelope with a Nickel-Chromium coiled filament, porcelain end caps, and threaded-screw (stud) terminations. Fast heat-up and cool-down performance. Available Wattages from 1500 to 3000 Watts per element. Available voltages from 120 to 480 Volts.

Controls:
OCH Series heaters are not manufactured with any control device on the unit. All controls are accessories and should be specified as such. Please consult the technical sales department of factory for help in determining applicable controls. Please follow installation instructions that accompany each heater.

Accessories:
Adjustable mounting brackets (stainless steel only), vertical mounting brackets (stainless steel only), wire guards, thermostats, SCR controllers, and power contactor panels.

Mounting Configurations & Reflector Pattern

- Mounting**
- Chain, surface mount or use our vertical mounting bracket as shown below. (Note:) All units must be mounted horizontally.
 - In-Built surface mounting bracket allows for fixture adjustment up to a 45° horizontal tilt.
 - As shown, the heater may be suspended at any horizontal angle desired.

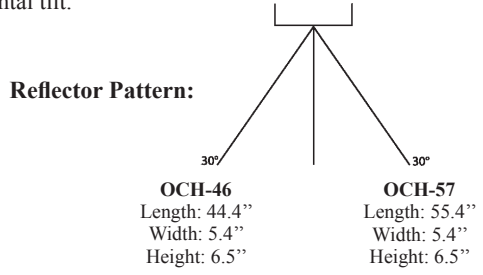
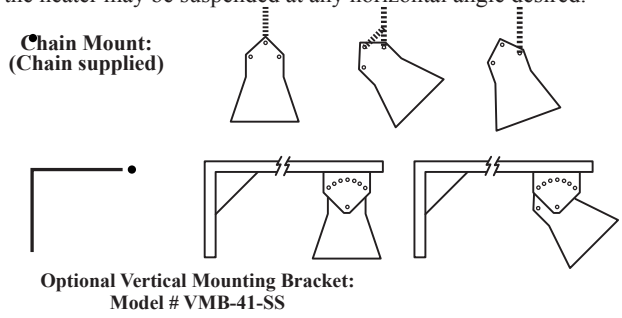

Mounting Clearances & Recommended Mounting Height

Mounting Clearances	Recommended Mounting Height	
3" from ceiling; 12" from vertical surface 72" from face of heater to combustible surface 36" from another heater	OCH-46	7'-9'
	OCH-57	8'-10'

RPH Series Outdoor Rated Stainless Steel Electric Infrared Heater



Mounting Plate (provided) on top center allows heater to be mounted parallel or angled using a standard pipe nipple and box cover (supplied by installer)

- Instant, high-intensity radiant heat, with 30° symmetric heat pattern.
- Listed for indoor spot heating and for outdoor unprotected applications.
- Specialized Ruby “Red” Quartz Lamp infrared heating element for glare reduction.
- Stainless Steel housing with Coilzak Aluminum reflector for good reflectivity & corrosion resistance.
- Heating element and mounting plate included.
- Dimensions: 24” x 5-3/8” x 4-1/2.”



Manufactured in U.S.A.

Mounting Clearances				Recommended Mounting Height	
6” from ceiling 24” from vertical surface 72” from face of heater to combustible surface				RPH-208	8’-12’
				RPH-240	8’-12’

UPC# 686334	MODEL	WATTS	BTU’S	VOLTS	PHASE	AMPS	REPLACEMENT QUARTZ LAMP	WT. (LBS.)	LIST	Optional Wireguard		
										UPC# 686334	MODEL	LIST
884501	RPH-208-A	1600	5,461	208	1	7.7	632-1620	5	344	880992	RPHWG	34
884518	RPH-240-A	1600	5,461	240	1	6.7	632-1624	5				

MM Series “Mitey Midget” Electric Infrared Heater



Manufactured in U.S.A.

- Instant, high-intensity radiant heat, with 60° symmetric heat pattern.
- MM heaters excel as people-heaters in areas requiring a linear, compact & concentrated heat source.
- Listed for indoor industrial and commercial comfort heat applications.
- Heavy duty Aluminum extrusion with a bright Aluminum insert for maximum reflectivity.
- Anodized Aluminum housing, (0.62” thick).
- Heat Element Sold Separately.
- Dimensions: 3.750” Wide x 3.380” High.

Mounting Clearances
24” from ceiling & from vertical surface 24” from face of heater to combustible surface 36” from another heater

UPC 686334	MODEL	MAX WATTS	MAX BTU'S	VOLTS	PH	UNIT LENGTH	WT. (LBS.)	LIST	Optional Wireguards		
									UPC 686334	MODEL	LIST
444019	MM-13A	500	1707	120	1	13"	3	234	443906	MMWG-13	24
442763	MM-18A	750 / 1000	3413	208-240	1	18"	4	244	443913	MMWG-18	36
449540	MM-24A	900 / 1600	5461	208-277	1	24"	5	254	441896	MMWG-24	46
442725	MM-33A	2500	8533	480	1	33"	6	273	443920	MMWG-33	50
442039	MM-46A	3000 / 3800	12457	480-600	1	46"	7	299	442046	MMWG-46	60

All MM-13A through MM-46A models are ETL Listed for use with Quartz Lamps Only!

FFH Series Electric Utility Infrared Heater

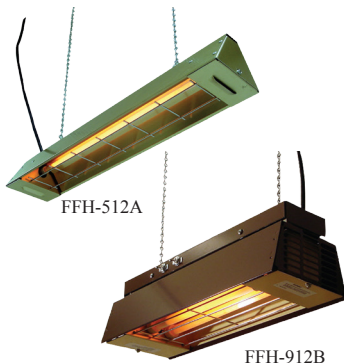

Manufactured in U.S.A.

- Both FFH Series Heaters are excellent for Farrowing & Finishing applications.
- Both units feature an 8 ft. 18/3 grounded cordset to plug into any 120V service.
- Gold anodized Aluminum reflectors, with a 90° symmetrical reflector pattern.
- Compact housing design, with the following housing finish:
FFH-512A: Gold Anodized Finish
FFH-912B: Brown Enamel Finish
- Quartz Tubes Heat Element(s), Wire Guard & (2) 4’ ft. Jack Chains are included.
- FFH-912B Only: Offers (2) On/Off toggle switches to operate heating elements independently.
- Listed for indoor industrial and commercial comfort heat

SIZING CHART - FFH SERIES					
MOUNTING HEIGHT	Heater Model	LENGTH	WIDTH	COVERAGE (Sq. Ft.)	WATTS / Sq. Ft.
6'	FFH-512A	7	6	42	13.1
	FFH-912B	6	7	42	21.4
7'	FFH-512A	8	7	56	9.8
	FFH-912B	7	8	56	16.1
8'	FFH-512A	9	8	72	7.6
	FFH-912B	8	9	72	12.5

UPC# 686334	MODEL	WATTS	BTU'S	VOLTS	PHASE	AMPS	REPLACEMENT QUARTZ TUBE	WT. (LBS.)	Dimensions (in.)			LIST
									Length	Width	Height	
883894	FFH-512A	550	1877	120	1	5	671-3492	4	22	5	3	225
882781	FFH-912B	450/900	3072	120	1	8	671-3454	4	17	6	4	410

Mounting Clearances
3” from ceiling 24” from vertical surface 72” from floor

Electric Infrared Heating Elements

Clear & Red Quartz Lamps

Notes: Life expectancy of all heating elements - 5,000 hours (4yr. Pro-rated Warranty). All heating elements operate at 50 / 60 Hertz.

UPC 686334	Item #	Watts	Volts	Length (in.)		Fits Model	LIST	UPC 686334	Item #	Watts	Volts	Length (in.)		Fits Model	LIST
				Overall	Heated							Overall	Heated		
440059	630-05129	500	120	8-11/16	5	MM-13A	101	440363	631-25489	2500	480	28-11/16	25	342, 343 or MM-33A	162
442770	630-10209	1000	208	13-11/16	10	MM-18A	178	440684	631-25609	2500	600	41-11/16	38	462, 463 or MM-46A	222
444118	630-10249		240				107								234
440165	630-16209	1600	208	19-11/16	16	222, 223 or MM-24A	119	440677	630-36489	3650	480	41-11/16	38	462, 463 or MM-46A	222
440172	630-16249		240				119								234
440998	631-16249		240				144								222
440189	630-16279		277				119								234
481731	630-16489		480				144								234
481748	630-25209		208				169								RED QUARTZ LAMPS
481755	630-25249	2500	240	28-11/16	25	342, 343 or MM-33A	190	446150	632-1620	1600	208	19-11/16	16	222/223 or RPH	144
481762	630-25279		277				190	446167	632-1624	1600	240	19-11/16	16	222/223 or RPH	144
440547	630-25489		480				150	446228	632-2548	2500	480	28-11/16	25	342 or 343	169

Model Suffix: 630 = Horizontal Burning "Clear"; 631 = Vertical OR Horizontal Burning "Clear"; = Horizontal Burning "Red"

- Color temperature emitted: approx. 4100° F (high brightness).
- Approximately 96% radiant efficiency.
- Excellent resistance to thermal shock.
- 3/8" Diameter clear or red quartz envelope.
- Coiled tungsten filament; sealed porcelain end caps; halogen gas filled.

Quartz Tubes

Notes: Life expectancy of all heating elements - 5,000 hours. All heating elements operate at 50 / 60 Hertz.

UPC 686334	Item #	Watts	Volts	Length (in.)		Fits Model	LIST
				Overall	Heated		
443234	671-3784	1500	120	39-11/16	34-3/16	OCH-46	124
441810	671-5061	2000	208	39-11/16	34-3/16		
441803	671-3785	2000	240	39-11/16	34-3/16		
441933	671-5018	2000	277	39-11/16	34-3/16		
441667	671-5060	3000	208	50-11/16	45-3/16	OCH-57	138
441476	671-3786	3000	240	50-11/16	45-3/16		
441940	671-5059	3000	277	50-11/16	45-3/16		
441957	671-5058	2250	480	50-11/16	45-3/16		
440356	671-3454	450	120	12-15/16	8-7/16	FFH-912B	78
440080	671-3492*	550	120	19-1/2	16	FFH-512A	83
446242	671-5056	1000	120	18-5/16	14-7/16	CH-2212-1C	91
446259	671-5057	1425	240	27-5/16	23-7/16	CH-6424-1C	104

*3/8" Diameter

- 5/8" Diameter frosted quartz envelope
- Nickel-Chromium alloy coiled element with porcelain end caps and pigtailed termination
- Color temperature emitted: approx. 1800° F (bright orange glow)
- Approximately 60% radiant efficiency
- Fast heat-up/cool-down
- Moisture resistance: High
- Mechanical ruggedness: Good

Metal Sheath Elements

Notes: Life expectancy of all heating elements - 5,000 hours. All heating elements operate at 50 / 60 Hertz.

UPC# 686334	MODEL	WATTS	VOLTS	LENGTH (in)		Replacement Heating Element		LIST
				Overall	Heated	Fits "CH-Models"	Fits "FHK Models"	
445870	641-37211	1800	120	23-1/16	18	CH-212-1A	FHK-212-1CA	144
445832	641-35661	208	CH-220-1A, CH-620-3A			FHK 2.0 & 6.0 KW Models		
445795	641-35611	240	CH-224-1A, CH-624-3A					
445849	641-36051	277	CH-277-1A, CH-627-3A					
445801	641-35621	480	CH-248-1A, CH-648-3A					
445887	641-50011	600	CH-257-1A, CH-657-3A					
445856	641-36061	208	44-7/16	39	CH-420-1A, CH-1320-3A, CH-2720-3B	FHK 4.5 & 13.5 KW Models	189	
445818	641-35631	240			CH-424-1A, CH-1324-3A, CH-2724-3B			
445863	641-36071	277			CH-427-1A, CH-1327-3A			
446174	641-35641	480			CH-448-1A, CH-1348-3A, CH-2748-3B			
445894	641-50021	600			CH-457-1A, CH-1357-3A, CH-2757-3B			

- 0.430" Diameter Incoloy metal sheath envelope
- Nickel-Chromium alloy coiled element imbedded in Magnesium Oxide insulating powder
- Color temperature emitted: approx. 1600° F (dull orange glow)
- Approximately 50% radiant efficiency
- Slowest heat-up/cool-down
- Moisture resistance: Lowest
- Mechanical ruggedness: Highest

UPC# 686334	MODEL	WATTS	VOLTS	LENGTH (in)		Replacement Heating Element		LIST
				Overall	Heated	Fits "CH-Models" Only		
445788	641-70321	1800	120	24-1/16	18	CH-212-1C	144	
445702	641-70241	208	CH-220-1C, CH-620-3C					
445719	641-70251	240	CH-224-1C, CH-624-3C					
445726	641-70261	277	CH-227-1C, CH-627-3C					
445733	641-70271	480	CH-248-1C, CH-648-3C					
445771	641-70281	600	CH-257-1C, CH-657-3C					
445597	641-70001	208	45-7/16	39	CH-420-1C, CH-1320-3B, CH-2720-3C	189		
445603	641-70011	240			CH-424-1C, CH-1324-3B, CH-2724-3C			
445610	641-70021	277			CH-427-1C, CH-1327-3B			
445627	641-70031	480			CH-448-1C, CH-1348-3B, CH-2748-3C			
445665	641-70041	600			CH-457-1C, CH-1357-3B, CH-2757-3C			

Note: Inner reflector shipped with replacement Metal Sheath Elements.

Variable Controllers



VHC-32

Manufactured in U.S.A.

- Solid State phase angle variable “Triac” knob controller adjusts heat settings from 10-100% with heat loads up to 15.4-Amps.
- 208/240 VAC single-phase, single stage controller, 3200 Watt max.
- Positive “Off” & built-in On/Off Rocker switch lights “red” during operation.
- NEMA 1 Aluminum enclosure with stainless steel face plate designed for wall mounting or suitable for semi-recessed applications.
- Must be mounted in a protected area.
- Can either operate Quartz Lamps or Quartz Tube Infrared Heaters.



VHC-15

Manufactured in U.S.A.

- Solid state variable device controls heat loads up to 15-Amps.
- 208/240 Volt “In-Line” Controller.
- Built in On/Off knob switch with positive “off” & surface plate included.
- Designed for a 2” x 4” electrical wall box mounting (not supplied).
- Must be mounted in a protected area.
- Can only operate Fostoria Quartz Tube Infrared Heaters.

30-Amp or 80-Amp Enclosed



18D-2-80CF ENC.

Manufactured in U.S.A.

- SCR Voltage Controller - 80 Amp MAX.
- Includes (1) 24-volt Potentiometer (3” square) to control the heat output.
- Only operates Quartz Lamps at 240 or 208-Volts, single phase only.
- Potentiometer can be mounted outside, but the SCR must be located in a protected area.
- Factory wired with millisecond fuses included.

UPC 686334	Model	Description	Dimension (In.)			Wt.	LIST
			Depth	Width	Height		
485357	VHC-32	Variable Heat Controller 208/240-Volt; 15.4 Amp	3	5	5	3 lbs.	422
445948	VHC-15	Variable Heat Controller; 208/240-Volt; 15 Amp	3	5	5	3 lbs.	162
445634	18D-2-30CF (Open)	SCR Controller - 26 Amp MAX; No Enclosure	6	6	9	11 lbs.	942
445641	18D-2-30CF (Enclosed)	SCR Controller - 26 Amp MAX; Enclosure Included	8	10	12	15 lbs.	1398
445658	18D-2-80CF (Enclosed)	SCR Controller - 80 Amp MAX; Enclosure Included	8	12	14	29 lbs.	2278

Snow & Ice Detectors



CIT-1



APS-3C

Manufactured in U.S.A.

- Main control unit for Automatic Snow & Ice Control Systems.
- By sensing both temperature and moisture the system activates and melts any snow & ice accumulations until conditions subside.
- NEMA 3R Enclosure is UL Listed and houses timers and switching electronics to operate the system.
- Capability to monitor up to 6 sensors (CIT-1).
- Unit can be manually activated and can be controlled and monitored from an optional remote switch (Model RCU-).
- Positioned above ground to maximize the sensors capability.
- Detects falling or blowing of precipitation such as snow when the temperature is below 38° F.
- Most common sensor device.

UPC# 686334	Model	Description	Dimension (In.)			Wt.	LIST
			Depth	Width	Height		
319614	APS-3C	Snow / Ice Control Switch	6.56	11.5	9.25	8 lbs.	2533
319761	CIT-1	General Purpose Snow Sensor	3.25	3.25	4.13	1 lb.	911

Note: Any snow & ice control system should be used with the correct sized control panel (with contactors & fusing) as supplied by factory or your electrical contractor. Also, the APS-3C requires a control device (RCU-1, CIT-1, SIT-6E) in order to operate properly.

Contactors Enclosures



FEC-30-120

Manufactured in U.S.A.

- Economical load handling / switch device, ideal for use with other control equipment.
- NEMA 1 Enclosures.
- Load rating up to 600V Max., 3-Pole.
- Magnetic contactor.

UPC 686334	Model	Contactor Amps	Coil Voltage	Cabinet Size (In.)			Wt. (LBS.)	LIST
				Depth	Width	Height		
440851	FEC-30-120	30	120	5	6	10	5	194
440868	FEC-30-240		208/240					
440875	FEC-60-120	60	120					260
440882	FEC-60-240		208/240					

Note: Installer to provide overload protection for all infrared heaters.

Pre-Wired Contactor Panels

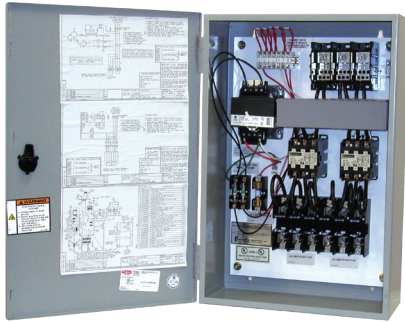

FPC2120



Manufactured in U.S.A.

- Factory pre-wired for quick installation, with the following optional equipment:
 Snow & Ice Detector (APS-3C)
 Single & Two-Stage Thermostats
 Two-stage thermostats require a minimum 2-contactors.
- Step-down transformer and secondary fusing for 24V or 120V control circuit.
- 3-Phase load rated.
- Fuses are NOT included.
- NEMA 1 Enclosures.
- Max 50-Amp branch circuit fusing.

Note: Contact factory for 3R, 4, 4X, & NEMA 12 “special” built models.

IMPORTANT FUSING INFORMATION

Fuses are NOT included since panels can be used with various infrared heat sources. Quartz Lamp Heat Sources: Use FRS-600V (or equal) “Time Delay” fuses; Class RK-5. Quartz Tube & metal Sheath Heat Sources: Use KTS-R 600V (or equal) “Fast Acting” fuses; Class RK-1. Fuse circuits as close to calculated load as possible. Circuits less than 35 Amps will require the use of fuse reducers.

Standard Models

120-V CONTROL SYSTEM		24-V CONTROL SYSTEM		MAX AMPS	VOLTS	CABINET SIZE (IN.)			WT. (LBS.)	LIST
UPC# 686334	MODEL	UPC# 686334	MODEL			DEPTH	WIDTH	HEIGHT		
4459902	FPC8110	4864302	FPC8210	50	208	6.75	16	24	52	1752
4460002	FPC2110	4864402	FPC2210		240					
4460102	FPC7110	4864502	FPC7210		277/480					
4460202	FPC4110	4864602	FPC4210		480					
4460302	FPC8120	4864702	FPC8220	100	208	6.75	16	24	70	2142
4460402	FPC2120	4864802	FPC2220		240					
4460502	FPC7120	4864902	FPC7220		277/480					
4460602	FPC4120	4865002	FPC4220		480					
4460702	FPC8140	4865102	FPC8240	200	208	6.75	24	30	88	3143
4460802	FPC2140	4865202	FPC2240		240					
4460902	FPC7140	4865302	FPC7240		277/480					
4461002	FPC4140	4865402	FPC4240		480					
4461102	FPC8160	4865502	FPC8260	300	208	6.75	30	36	106	3865
4461202	FPC2160	4865602	FPC2260		240					
4461302	FPC7160	4865702	FPC7260		277/480					
4461402	FPC4160	4865802	FPC4260		480					

FHK Series Portable Metal Sheath Electric Infrared Heater



2.0KW & 4.5KW
Stand Models

6.0KW & 13.5KW
Hand Cart Models

- Double side wall housings to reduce operating temperatures.
- 6.0 and 13.5KW heaters have double top baffles to reduce operating temperatures.
- 60° symmetrical heat pattern.
- Factory installed U-shaped metal sheath infrared heating elements have an average 5000 hour life.
- Heavy duty protective wire screens.
- GOLD anodized Aluminum internal reflector.
- Ground fault protection must be used.

Square Feet Heated

KW	NON-PROTECTED AREA		SEMI-PROTECTED AREA		Required Clearance From Front of Heater
	BELOW 35 °F	ABOVE 35 °F	BELOW 35 °F	ABOVE 35 °F	
1.8 / 2.0	25	36	40	50	2 feet
4.5	64	75	90	125	3 feet
6	85	100	120	150	4 feet
13.5	192	225	270	375	7 feet

Manufactured in U.S.A.

Standard FHK Models

UPC# 686334	MODEL	KW	BTU's	VOLTS	PH	AMPS	WT.	LIST	OPTIONAL 25' POWER CORD		
									UPC# 686334	MODEL	LIST
881739	FHK-224-1A	2.0	6,826	240	1	8.3	17 lbs.	502	880435	SO 16/3	92
881753	FHK-248-1A			480	1	4.2			880435	SO 16/3	
881784	FHK-424-1A	4.5	15,359	240	1	18.8	24 lbs.	561	880459	SO 12/3	130
881807	FHK-448-1A			480	1	9.4			880466	SO 14/3	103
882910	FHK-624-3A	6.0	20,478	240	3	14.4	37 lbs.	966	880497	SO 14/4	130
					1	25.0			880442	SO 10/3	142
882934	FHK-648-3A			480	3	7.5			880497	SO 14/4	130
					1	13			880466	SO 14/3	103
882965	FHK-1324-3A	13.5	46,076	240	3	33.0	65 lbs.	1601	880510	SO 8/4	269
				480	3	17.0			316422	SO 12/4	141
882989	FHK-1348-3A				1	29.0			880527	SO 8/3	239

Contact Factory for Special Build Models @ 208V, 277V or 600V.

Factory Pre-Wired FHK Models With 15 Ft. Cord & Grounded Plug

UPC# 686334	MODEL	TYPE	KW	BTU's	VOLTS	PHASE	AMPS	WT.	LIST
881715	FHK-212-1CA	STAND	1.8	6,143	120	1	15.0	18 lbs.	482

FHK Infrared Control Options

UPC 686334	MODEL #	DESCRIPTION	Operating Voltage (VAC)	Dimensions (In)			WT. (lbs.)	LIST
				Ht.	Wd.	Dp.		
485814	TO-SK-1	Tip-Over Switch	208V - 600V	10.3	10.3	5.0	12	397
589376	DC-SK-1	Disconnect Switch	120V - 600V	5.0	6.0	4.0	5	360
486026	GF-SK-1	Ground Fault Sensing Switch	208V - 600V	10.3	10.3	5.0	12	737

Model "TO" & "GF" features include a positive "off" & a built-in on/off rocker switch that glows red during operation. Additionally, enclosure can mount directly to the terminal box on the back of the heater (FHK-6/13 only) or be mounted to a remote wall surface.



TO-SK-1 or GF-SK-1

Note: All SK-1 Models have NEMA-1 Enclosure, 50-Amp Max. & 1/3-Phase Rated.

CH Series Portable Quarts Infrared Heater

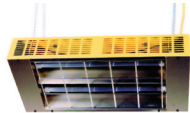

Chain mounted
CH 2212-1C



Portable Cart Unit CH 6424-1C
with FHK-1 Cart

MODEL CH 2212-1C has two 1000 Watt elements that can be switched on / off by toggle switches to produce 1000 Watts or 2000 Watts of heat. - 15' cord and NEMA 5-20 molded plug.

MODEL CH 6424-1C has two sets of 1425 Watt elements that can be switched on / off by toggle switches to produce 2850 Watts or 5700 Watts of heat. - 15' cord and NEMA L6-30 twist lock plug.

- 60° symmetrical heat pattern.
- Quartz tubes and built in wire guards included.
- Interior or protected outdoor use only.
- GOLD anodized Aluminum reflector and end caps.

UPC 686334	MODEL	KW	BTU's	VOLTS	PHASE	AMPS	WT.	LIST	
884099	CH-2212-1C	2.0 / 1.0	6826 / 3413	120	1	16.7 / 8.35	16 lbs.	547	
884105	CH-6424-1C	5.7 / 2.85	19454 / 9727	240	1	23.8 / 11.9	31 lbs.	901	
852401	FHK-1	OPTIONAL CART						20 lbs.	129



Note: CH-2212-1C operates with a 20- Amp molded plug.



Note: CH-6424-1C operates with a 30- Amp twist lock plug. **Manufactured in U.S.A.**



Listed for overhead operation

PCH Series Portable Quartz Infrared Spot Heater

Portable Infrared Instant On-Off Heat Gun



Width: 53"
Height: 2-6"
Depth: 28"



Features

- Suitable for portable spot heat or for curing clear coat paint
- Height adjustable from 2' to 4'
- On-Off rocker switch standard
- 4 casters included; Tip-Over power cutoff safety switch
- 60° symmetrical heat pattern
- 5/8" diameter quartz tube included

- Average element life is 5000 hours
- Bright Aluminum reflector and end caps
- 20 gauge powder coated Steel housing
- 15' long, 3 wire (14/3) cordset with standard 3 pring NEMA 5-20P

UPC# 686334	MODEL	WATTS	BTU's	VOLTS	PHASE	WT.	LIST
884112	PCH-48C	1500	5120	120	1	30	504

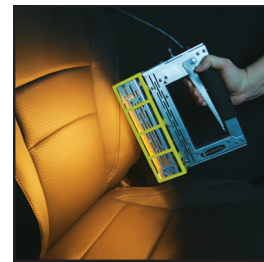

Features

- Provides instant spot heat in a controlled pattern
- Spot cure retouched paint and other finishes
- De-wrinkle or relax materials such as cloth-vinyl-leather
- T-3 Tungsten IR lamp
- Spring loaded power button switch

- 10' long, 18/3 grd. cordset with NEMA plug

UPC# 686334	MODEL	WATTS	VOLTS	AMPS	WT.	LIST
592284	RHG-1012A	1000	120	8.4	3	2063
592277	RHG-1012B					1500

Portable Electric Infrared Heat Panels

Features

- Portable panels are built to withstand rigors of industrial and heavy-commercial applications, such as auto collision repair shops.
- 20 gauge Steel frame, base, and housing construction.
- 3" Steel casters for high stability and ease of mobility
- Gold anodized Aluminum reflectors and end caps allow 10% faster cure time than polished Aluminum reflectors, especially in paint and dust-laden atmospheres.
- Elements achieve full temperature in less than 2 minutes
- Fused disconnect switches are installed on the back of each unit.
- Units are positioned with adjustable hinges allowing the user to use direct heat more precisely to the target area.
- Gentle but effective medium-wave radiant heat can quickly boost, flash-off, or cure a variety of finishes, and lessens the chance of blistering and/or overheating the coating.
- Medium-wave infrared heating elements are also effective for flash-off of water-based clear coatings being mandated by environmental agencies in many states.

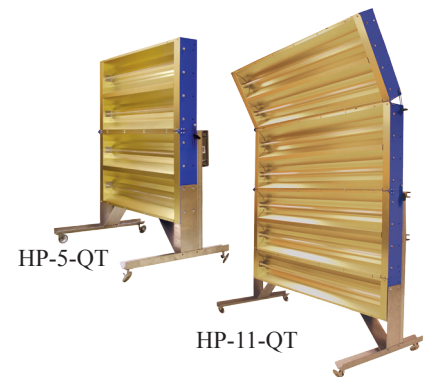

General Curing Guidelines

Material Type	Solvent Based Primer	Water Based Primer	Two Component Primer	Water Based Clear Coat	Acrylic enamel & Polyurethane Clear Coat	Urethane Clear Coat & High Solids Top Coat
Curing Time	3-5 mins	3-6 mins	8-20 mins	3-10 mins	12-30 mins	10-30 mins

Note: Curing times will vary depending on material and shop conditions. This chart is based on distances of 18-24" away from the target area.

Standard Models

UPC# 686334	Model	WATTS	VOLTS	AMPS	HEAT SOURCES	CABLE TYPE (20')	Dimension (In.)		Heated Area (In.)		Wt.	LIST
							Width	Height	Width	Height		
884129	HP-5-QT	4,800	240	20	4	12-3 SO	44-5/8	56-1/2	40	44	116	2725
884136	HP-6-QT	6,400		26.7	4		66-5/8		61		141	3150
884143	HP-11-QT	11,200		46.7	7	6-3 SO	89-1/2	77	225	5800		

FES Series Product Features & Information



Manufactured in U.S.A.



AVERAGE MINUTES TO ACHIEVE TEMPERATURE RISE*						
BUILDING SIZE:	1000 SQ. FEET		1500 SQ. FEET		2000 SQ. FEET	
HEATER:	TEMP RISE		TEMP RISE		TEMP RISE	
	20 °F	40 °F	20 °F	40 °F	20 °F	40 °F
10 KW	70 min	140 min	105 min	210 min	---	---
15 KW	47 min	94 min	71 min	142 min	94 min	188 min
30 KW	23 min	46 min	35 min	70 min	47 min	94 min
45 KW	10 min	30 min	20 min	35 min	35 min	40 min

* Based on a 15' ceiling height - lower ceiling height will reduce time required

- Safety yellow heater enclosure with safety screens on both air intake and output openings.
- Optional 25' long SO type cord, ready for plug attachment is available for each model.
- Long-life finned tubular heating elements.
- Thermostat adjustment 40° to 100° F.
- Magnetic contactor.
- Automatic reset.
- High-limit thermal cutout switch.
- Fan only switch.
- 10" wheels.
- 800 CFM-15KW units - 1100 CFM-30KW units.

THE ELECTRIC
ALTERNATIVE TO
PROPANE AND
KEROSENE SPACE
HEATERS

Standard FES Models

UPC#	MODEL	KW	BTU's	VOLTS	PH	AMPS	TEMP RISE	WT.	LIST
886017	FES-1520-3A	15	51195	208	3	42	45°F	65 lbs.	1609
886079	FES-1524-1A	15	51195	240	1	63	45°F	69 lbs.	
886024	FES-1524-3E	15	51195	240	3	36	45°F	65 lbs.	
886031	FES-1548-3E	15	51195	480	3	18	45°F	65 lbs.	
886048	FES-1560-3A	15	51195	600	3	15	45°F	65 lbs.	
886055	FES-3048-3A	30	102390	480	3	36	90°F	83 lbs.	2537
886062	FES-3060-3A	30	102390	600	3	29	45°F	65 lbs.	2665

OPTIONAL 25' POWER CORD*		
UPC 686334	MODEL	LIST
316408	SO 6/4	295
880530	SO 4/3	256
316408	SO 6/4	295
316422	SO 12/4	149
316408	SO 6/4	295
316422	SO 12/4	149

10 KW, 240V, 1Phase factory pre-wired model with 10 ft. cable & straight blade range plug.

*Plug not included.



UPC	MODEL	KW	BTU's	VOLTS	PHASE	AMPS	TEMP RISE	WT.	LIST
874434	FES-0924-1C	9	30717	240	1	38	25°F	55 lbs.	1532
886000	FES-1024-1CA	10	34130	240	1	42	30°F	60 lbs.	1532

45 Kilowatt FES Model

OPTIONAL 25' POWER CORD		
UPC 686334	MODEL	LIST
316439	SO 4/4	300
316408	SO 6/4	295

- Safety yellow heater enclosure with safety screens on both air intake and output openings.
- Optional 25' long SO type cord, ready for plug attachment is available for each model.
- Long-life finned tubular heating elements.
- Thermostat adjustment 40° to 100° F.
- Two 10" rear wheels and a front locking caster.
- High-limit thermal cutout switch with manual reset.
- 2200 CFM
- Fan only operation feature



UPC	MODEL	KW	BTU's	VOLTS	PH	AMPS	TEMP RISE	WT.	LIST
872225	FES-4548-3	45	153585	480	3	54.2	70°F	125 lbs.	4196
487405	FES-4560-3	45	153585	600	3	44	70°F	125 lbs.	4410



Standard YES Models

- Wall / ceiling mount included with unit
 - Unit is ready for direct wiring
- Manufactured in U.S.A. • Thermostat adjustment 40° to 100° F.



UPC	MODEL	KW	BTU's	VOLTS	PHASE	AMPS	TEMP RISE	WT.	LIST
886086	YES-1520-3A	15	51195	208	3	42	45°F	60 lbs.	1532
886185	YES-1524-1A	15	51195	240	1	63	45°F	60 lbs.	
886093	YES-1524-3E	15	51195	240	3	36	45°F	60 lbs.	
886109	YES-1548-3E	15	51195	480	3	18	45°F	60 lbs.	
886123	YES-3048-3A	30	102390	480	3	36	90°F	72 lbs.	2416



Wall Mounted



Ceiling Mounted

198 Series 120 Volt Radiant and/or Fan Forced Portable Heater

- 3-Heat settings:
 - 600 Watt radiant
 - 900 Watt fan forced
 - 1500 Watt radiant & fan forced
- Temperature control thermostat
- Dual safety system:
 - Tip over switch
 - Manual reset type limit control
- 6' long - 3 conductor cord
- 1 year limited warranty

Width: 11"
Height: 15"
Depth: 12"



Standard Models

UPC 686334	MODEL	WATTS	MAX BTU's	VOLTS	AMPS	PHASE	WT.	LIST
445092	198 TMC	1500 / 900 / 600	5120	120	12.5 / 7.5 / 5	1	9 lbs.	148



178 Series 120 Volt Ceramic Fan Forced Portable Heater



- Two heat settings: 1500W / 950W plus fan only setting (20W)
- Temperature control thermostat
- 6' long - 3 conductor cord
- Double safety system:
 - Automatic reset type limit control
 - Thermal cut-off device

Width: 11-1/4"
Height: 10"
Depth: 7"

Standard Models

UPC 686334	MODEL	WATTS	MAX BTU's	VOLTS	AMPS	PHASE	WT.	LIST
445931	178 TMC	1500 / 950	5120	120	12.5 / 7.1	1	8 lbs.	132

Note: Photograph is a representation of stocked models. Actual model may vary in appearance.

188 Series 120 Volt "Milk-house" Style Fan Forced Portable Heater

- 1300W & 1500W heat settings plus fan only setting
- Temperature control thermostat
- 6' long - 3 conductor cord
- Triple safety system:
 - Tip over switch
 - Automatic reset type limit control
 - Thermal cut-off device

Width: 10"
Height: 16"
Depth: 9-1/2"



Standard Models

UPC 686334	MODEL	WATTS	MAX BTU's	VOLTS	AMPS	PHASE	WT.	LIST
800419	188 TASA	1500 / 1300	5120	120	12.5 / 10.8	1	9 lbs.	88



"Under-The-Desk" Confined Space Radiant Heat Panel



Manufactured in U.S.A.



- Use under desks for personal comfort or in small areas for freeze protection or moisture removal.
- Built in stand.
- Temperature control thermostat.
- 6' long - 3 conductor cord

Width: 22-3/4"
Height: 8"
Depth: 1-3/4"

Standard Models

UPC# 686334	MODEL	WATTS	BTU's	VOLTS	PHASE	WT.	LIST
450881	170-TS	170	580	120	1	9 lbs.	157

483 Series 120 Volt Portable Baseboard Convection Heater

- 1500 Watt convection heater
- Temperature control thermostat
- Manual reset type limit control
- Power on indicator light
- 6' long - 3 conductor cord

Width: 48"
Height: 5-1/4"
Depth: 7-1/2"

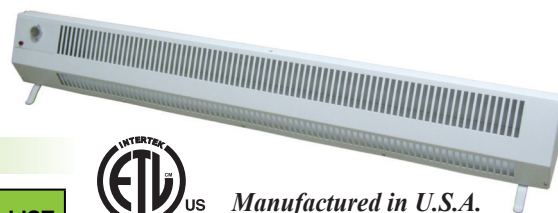

Manufactured in U.S.A.

Standard Models

UPC 686334	MODEL	WATTS	MAX BTU's	VOLTS	AMPS	PHASE	WT.	LIST
870887	483 TM	1500	5120	120	12.5	1	13 lbs.	156

474 Series 240 Volt Dual Heat Fan Forced Portable Heater



- 2000W & 4000W heat settings
- Temperature control thermostat
- Manual reset type limit control
- 6' long - 3 conductor cord

Width: 16"
Height: 16"
Depth: 8-1/2"



20 AMP Plug
NEMA #6-20P

UPC# 686334	MODEL	WATTS	MAX BTU's	VOLTS	AMPS	PHASE	WT.	LIST
446181	H474 TMC	2000 / 4000	13652	240	8.3 / 16.6	1	20 lbs.	229

5800 Series Garage/Workshop 240/208 Volt Fan Forced Portable Heater

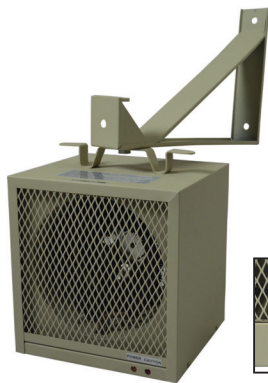

- Up to 4800 Watts of heating comfort for garage or utility room applications
- 4000 Watts available for smaller areas.
- Built in bi-metal double pole thermostat - 50° to 90° range.
- Steel tubular heating element
- Wall/Ceiling bracket included
- Manual reset standard
- Power on and overheat pilot lights

ITEM	WIDTH	HEIGHT	DEPTH
Heater	10.625	11"	9.625"
Bracket	2.5"	10"	14.0"



UPC# 686334	MODEL	WATTS	MAX BTU's	VOLTS	AMPS	PHASE	PLUG TYPE	WT. (LBS)	LIST
503402	HF5840TC	4000/3000	13652	240 / 208	16.6 / 14.4	1	20 Amp	17	225
503396	HF5848TC	4800/3600	15086		20 / 17.3		30 Amp		300

ICH Series 240/208 Volt Construction Site/Utility Fan Forced Portable Heater

- Operates on 240V or 208V
- Steel tubular heating element
- 43°F air heat rise
- Internal overheat thermostat
- Temperature control thermostat
- 6' long cordset

Width: 10 5/8"
Height: 12 3/4"
Depth: 10"



20 AMP Plug
NEMA #6-20P



UPC# 686334	MODEL	WATTS	MAX BTU's	VOLTS	AMPS	PHASE	WT.	LIST
450874	ICH-240C	4000 / 3000	13648	240 / 208	16.7 / 14.4	1	15 lbs.	247

680 Series "Bulldog" 240/208 Volt Fan Forced Portable Unit Heater



Swivel base allows unit to be wall, floor, or ceiling mounted.

- Operates on 240V or 208V
- Finned steel tubular heating element
- Internal manual reset thermal cut-out
- 6' long cord with molded plug
- Temperature control thermostat with 35°F to 85°F range
- 10' air throw - 262 CFM



20 AMP Plug
NEMA #6-20P
HF684TC



30 AMP Plug
NEMA #6-30P
HF685TC,
HF686TC

Width: 13 1/2"
Height: 17 1/2"
Depth: 11 1/2"

UPC# 686334	MODEL	WATTS	MAX BTU's	VOLTS	PHASE	AMPS	TEMP RISE	WT.	LIST	
446280	*HF684TC	4000/3000	13652/10239	240/208	1	16.7/14.5	48°F	20 lbs	377	
446297	HF685TC	4800/3600	16384/12288	240/208	1	20.0/17.4	58°F	20 lbs.	395	
446303	HF686TC	5600/4200	19107/14330	240/208	1	23.4/20.2	75°F	20 lbs.	443	
683500	A1560	OPTIONAL WALL CEILING BRACKET FOR HF680 & ICH 240c SERIES HEATERS								73

* HF684TC UL listed only

Specialty Heaters

RPH Series Pump House Convection Specialty Heater

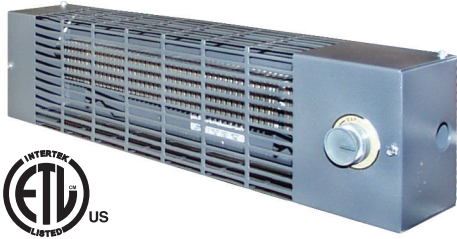

Manufactured in U.S.A.

- Provides protection against freezing for pump houses, utility rooms, relay stations, construction sheds, etc.
- Aluminum finned heating element
- Powder coated epoxy steel case
- Automatic temperature control thermostat with a 35°F to 65°F range.
- Dimension 20" x 5-1/2" x 4"

Standard Models

UPC# 686334	MODEL	WATTS	BTU's	VOLTS	AMPS	WT.	LIST
999083	RPH1-5A	500	1706	120	4.2	5 lbs.	200
999090	RPH2-5A	500	1706	240	2.1	5 lbs.	
International Models							
984263	RPH22-5Ai	500	1706	220	2.3	5	200
984270	RPH2-5Ai			240	2.1		

FH Series In-Floor Fan Forced Specialty Heater



Manufactured in U.S.A.

- Powder coated 20 gauge steel case
- 14 gauge grill
- Steel spiral finned heating element
- Auto reset thermal cut out with audible alarm.
- Floor opening: 14-1/8" x 7-1/4" x 7-3/8"
- Grill dimensions: 15-13/16" x 8-13/16"

Standard Models

UPC# 686334	MODEL	WATTS	BTU's	VOLTS	AMPS	WT.	LIST
378239	FH15	750	2560	120	6.25	15 lbs	572
		1500	5120	120	12.5		
		1500/1125	5120 / 3840	240/208	6.25/5.41		
OPTIONAL FIELD INSTALLED THERMOSTATS							
378277	FH1T	Single Pole Integral Thermostat Kit				11lb	148

TSH Series Fan Forced Kickspace Specialty Heater



Manufactured in U.S.A.

- Fits into soffits, stair risers or under utility cabinets
- Finned steel heating element.
- Manual reset thermal cut-out
- Recessed opening: 22-3/8" x 3-5/8" x 11-1/2"
- Grill dimensions: 23-7/8 x 3-5/16

Standard Models

UPC# 686334	MODEL	WATTS	BTU's	VOLTS	AMPS	WT.	LIST
381802	TSH20J	1500 / 1000	5120 / 3412	120	12.5 / 8.4	16 lbs	342
		1500 / 750	5120 / 2560	208	7.2 / 3.6		
		2000 / 1000	6284 / 3412	240	8.4 / 4.2		
970174	TSH20JW	Above Model with White Grill					
OPTIONAL FIELD INSTALLED THERMOSTATS							
378376	TSH1TX	Single Pole Integral Thermostat Kit				11lb	78
378383	TSH2TX	Double Pole Integral Thermostat Kit				11lb	

CF & CFH Series Variable Speed Air Curtains

Product Specifications

CABINET: Shall be constructed of 20 gauge rigid steel with baked on epoxy powder coat paint for durability.
DISCHARGE VANES: Shall extend the entire width of the unit and be adjustable for optimum performance of air flow.
BLOWERS: Shall be forward curved centrifugal type, DWDI with corrosion resistance scroll and wheel.
MOTORS: Shall be heavy duty, PSC, direct drive high efficiency and designed for use with SCR controllers. Motors shall be permanently lubricated for long life and have thermal over load protection. Motor shall have double insulation protection for quieter operation. Quick disconnects shall be supplied to accommodate easy installation and service of motor.



Manufactured in U.S.A.

SCR SPEED CONTROLLER: Supplied on all units compatible with the motor with low end adjustment for air volume control and savings in power consumption.
ELECTRIC HEAT (OPTIONAL): Electric heater available as field installed option. Electric heater shall be steel sheath element with helical wound steel fins for maximum heat transfer and safety.

UPC 686334	SIZE (in)	MODEL	FT. / MIN. HI - LOW	NOZZLE CFM	VOLTS	RPM HI - LOW	AMPS HI - LOW	WATTS HI - LOW	WT. (lbs)	LIST	
STANDARD UNITS: 1/2 HP MODELS - UP TO 10' HIGH DOORWAYS - WITHOUT HEAT SECTION											
671200	36	CF36	3288/455	2672/333	120	1659/620	3.9/3.4	472/154	74	1576	
671217	48	CF48	4168/786	4515/766		1606/583	4.4/3.6	519/189	82	1709	
671224	60	CF60	4168/764	6544/931		1636/562	4.4/3.8	509/199	90	1843	
	72	2 EA: CF36	3288/455	5344/666		1659/620	7.8/6.8	944/308	148	3062	
	96	2 EA: CF48	4168/786	9030/1532		1606/583	8.8/7.2	1038/378	164	3318	
	108	3 EA: CF36	3288/455	8016/999		1659/620	11.7/10.2	1416/462	222	4594	
	120	1 EA: CF48	4168/786	9859/1432		1606/583	12.2/10.4	1982/497	230	4721	
		2 EA: CF36	2672/333								
HEAVY DUTY UNITS: 3/4 HP MODELS - UP TO 12' HIGH DOORWAYS - WITHOUT HEAT SECTION											
671231	36	CFHD36	3288/1120	2672/819		120	1689/603	4.4/4.3	603/192	77	1659
671248	48	CFHD48	4256/929	4611/906	1662/500		5.9/4.8	586/168	85	1792	
671255	60	CFHD60	4256/924	5763/1126	1652/509		5.2/4.4	708/172	93	1930	
	72	2 EA: CFHD36	3288/1120	5344/1638	1689/603		8.8/8.6	1206/384	154	3222	
	96	2 EA: CFHD48	4256/929	9222/1812	1662/500		11.8/9.6	1172/336	170	3480	
	108	3 EA: CFHD36	3288/1120	8016/2457	1689/603		13.2/12.9	1809/576	231	4833	
	120	1 EA: CFHD48	4256/929	9955/2544	1662/500		14.7/13.4	2981/552	239	4961	
		2 EA: CFHD36	3288/1120								

EXAMPLE

Model #	Unit Width	KW	Volts	Phase
CFHTR	36	10.0	208	3

Use the example shown (left) to order unit with heat section by specification

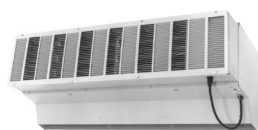

Air Curtain with Heater Module

NOTE: All heating sections are constructed of totally enclosed fin tubular elements for safety and longer operating life. With heating section installed, unit becomes a 24 Volt control unit and can utilize a low voltage thermostat for control of heating.

NOTE: For 72" through 120" units, order multiple heater modules corresponding to the actual air curtain models

MODEL	HEATER WIDTH	KW	VOLTS	PHASE	HEATER AMPS	MINIMUM CIRCUIT AMPS	MAXIMUM FUSE AMPS	BTUH	75°C WIRE AWG	LIST
CFHTR	36, 48, or 60 Inch Width	NOTE: 12KW MAXIMUM ON 36" WIDTH UNITS	3	3	208	10.4	15	10,239	14	36" - 1205 48" - 1331 60" - 1377
					240	9.0	15		14	
					480	4.5	15		14	
				277	13.5	15	14			
				208	18.0	20	12			
				240	15.6	20	12			
			5	3	208	17.25	20	12		
					240	15.0	20	12		
					480	7.5	15	14		
				277	22.5	25	10			
				1	208	30.0	35	8		
					240	26.6	30	10		
			480		13.3	30	10			
			7.5	3	208	26.0	30	10		
					240	22.5	25	10		
					480	11.3	15	14		
				1	277	33.8	40	8		
					208	45.0	50	6		
					240	39.0	45	8		
			10	3	208	34.4	40	8		
					240	30.1	35	8		
					480	15.0	20	12		
				1	277	45.1	50	6		
					208	52.0	60	6		
240	41.6	45			8					
12	3	208	36.0	40	8					
		240	18.0	20	12					
		480	14.4	18.0	12					
	1	277	54.1	60	6					
		208	52.0	60	6					
		240	36.0	55	6					
15	3	480	18.0	30	10					

SD Series - Setback on Demand Thermostat

FULLY AUTOMATIC: All the savings without any of the hassles of a programmable thermostat. Once installed, everything is automatic. When people are present it automatically controls to the comfort setting. When they leave, it automatically returns to the economy setting.

SMART COMFORT: The SD thermostat learns your schedule so you arrive to a comfortable temperature. Holidays are no problem. When no-one arrives, it automatically returns to the economy setting.

AUTO-CHANGEVER: Our Auto-Changeover doesn't limit your comfort settings. We incorporate an adjustable deadband to protect your equipment while maintaining comfort. Factory set at 1 degree, but adjustable from 1-5 degrees.

ONE MODEL WORKS WITH ALMOST ANY LOW VOLTAGE SYSTEM.: The SD thermostat works with low voltage systems up to 4 stages of heat, 4 stages of cool, or any combination up to a total of 4 stages including Heat Pumps.



Patent Pending

UPC# 686334	MODEL	COLOR	TYPE	LIST
523646	SDHW1001	White	Hardwire	375

ET Series - Line Voltage



Features

- Single pole and double pole
- Heat only, cool only, & heat or cool
- DP models include positive off
- Celsius and Fahrenheit temperature scale
- Optional Thermometer
- 22 Amps, 277 Volts AC

UPC #	MODEL	DESCRIPTION	LIST
686334			
538725	AET5DWS	Double Pole 22 Amp, 120-277V with leads, Anticipator	41.65
538732	AET5SWS	Single Pole 22 Amp, 120-277V with leads, Anticipator	37.40
538886	ET5DS	Double Pole 22 Amp, 120-277V, Heat Only	32.90
538749	ET5D4S	Double Pole 22 Amp, 120-277V, 35-75°F Temp Range	33.60
538756	ET5DTS	Double Pole 22 Amp, 120-277V, with Thermometer, Heat Only	34.30
538763	ET5DWS	Double Pole 22 Amp, 120-277V, Heat Only with Leads	33.60
538770	ET5MS	Heat Only, 2 Stage	35.70
538787	ET5SS	Single Pole 22 Amp, 120-277V, Heat Only	27.50
538794	ET5S4S	Single Pole 22 Amp, 120-277V, 35-75°F Temp Range	30.80
538800	ET5SRS	Single Pole 22 Amp, Cooling Only	27.30
538893	ET5SRTS	Single Pole Cool with Thermometer	30.80
538817	ET5STS	Single Pole 22 Amp, Heat Only with Thermometer	30.80
538824	ET5SWS	Single Pole 22 Amp, Heat Only with Leads	32.20
538831	ETD5MS	Double Throw, 2 Stage Heat, 1 Stage Cool	35.70
538848	ETD5MTS	2 Heat, 1 Cool with Thermometer	37.10
538855	ETD5SS	Single Pole Double Throw Heat/Cool	30.80
538862	ETD5STS	Single Pole Double Throw Heat/Cool with Thermometer	32.20

EPET Series and HLT Series Hazardous Location



Features

- SPDT & DPDT Models
- Heat or cool compatible
- Celsius and Fahrenheit temperature scale
- Bi-Metal or capillary sensor
- Snap action switch
- Casting tapered top and bottom for 3/4" conduit
- 1/2" thick cast Aluminum housing
- Dimension 5-3/4" x 6-3/8" x 5.57"

Motor Rating (full load): 3/4 HP @ 125V, 1-1/2 HP @250V
 Pilot Duty Rating 125VA @ 24VAC
 NEMA Class Seven Div. 1 Approved
 Class I Group C & D, Class II Group E, F, & G
 Not rated for Group B

UPC#	MODEL	DESCRIPTION	LOAD RATINGS	RANGE	LIST
686334					
538077	EPETD8D	DPDT - Bi-Metal	22A @120-277VAC	50-90°F	453
538107	EPETD8S	SPDT - Bi-Metal	22A @120-277VAC	50-90°F	429
528078	EPETP8D	DPDT - Bi-Metal	22A @120-480VAC	50-90°F	467
528061	EPETP8S	SPDT - Bi-Metal	22A @120-480VAC	50-90°F	442
523158	HLT-1	SPDT - Capillary	22A @120-277VAC	40-110°F	476
523165	HLT-2	DPDT - Capillary	22A @120-277VAC	40-110°F	502
Master ctn: 4 pcs, 24 lbs (varies slightly by model), 16" x 14.5" x 6"					
EPET Series incorporate plastic knob & Bi-Metal Sensor housing.					
HLT Series incorporates screwdriver temperature adjustment slot and all metal housing. External bulb and capillary sensor.					

2000 Series - Line Voltage



Features

- White or Ivory
- Single pole and double pole
- Heat Only
- DP models include positive off
- 22 Amps, 277 Volts AC

UPC#	MODEL	COLOR	DESCRIPTION	LIST
686334				
502849	S2022H10AA	White	Single Pole with leads, 22 Amp	34
502436	S2022H10AB	Ivory		
502856	D2022H10BA	White	Double pole with leads, 22 Amp	45
502443	D2022H10BB	Ivory		
502917	S2025H10AA	White	Single Pole with leads, 25 Amp	51
502924	D2025H10BA	White	Double pole with leads, 25 Amp	60

Thermostats & Controls

TW Series



Features

- Single and double pole models
- Wire leads
- Tamper resistant

Load Rating

- 22 Amps resistive @ 120 VAC
- 18 Amps resistive @ 277 VAC

UPC# 686334	MODEL	DESCRIPTION	TEMPERATURE SCALE	LIST
502009	TW145	SP, Beige with Leads	Tamper Resistant	59
502016	TW146	DP, Beige with Leads	Tamper Resistant	69
Master Carton: 25 Pcs, 12 lbs. (varies slightly by model), 16" x 14" x 5.5"				

Washdown Series



Features

- Single and double pole models
- Rain tight NEMA 4X rating
- Stainless steel hardware
- Coil capillary temperature sensor

UPC# 686334	MODEL	DESCRIPTION	TEMPERATURE SCALE	LIST
523424	TW155A	SP, Rain tight	40-110°F	179
523431	TW255A	DP, Rain tight	40-110°F	209
22 Amps @ 120/250/277 VAC, 5" x 5" x 3" Case				

Industrial Series



Features

- Coil capillary (CKT) models
- Bi-Metal models (KT)
- Rugged steel case
- SPST & SDPT models
- Hard wired models rated for 22A resistive @125-250 VAC
- Coded models rated for 13A resistive @125VAC

UPC# 686334	MODEL	DESCRIPTION	RANGE	CONNECTIONS	SCALE	LIST
534048	CKTD110	SPDT Heat or Cool	40 - 110°F	Wire Leads	F	110
534086	KT110	SPST Heat Only	-10 - 100°F	Wire Leads	C & F	46
534109	KT121	SPST Heat Only	-10 - 100°F	6' Cord/Plug	C & F	51
534178	KTD110	SPDT Heat or Cool	-10 - 100°F	Wire Leads	C & F	47
534369	KTO110	SPST Cool Only	-10 - 100°F	Wire Leads	C & F	47
534215	KTO121	SPST Cool Only	-10 - 100°F	6' Cord/Plug	C & F	51
Master Carton: 13.75" x 14" x 9", Qty 9-12, 14lbs.-16lbs. depending on model						

L Series



Features

- 6' or 8' Capillary
- Rugged steel cage
- SPDT for Heat or Cool
- 25A resistive
- Rated differential of 6°F

UPC# 686334	MODEL	DESCRIPTION	RANGE	CAPILLARY	SCALE	LIST
534260	L06Y-01	SPDT Heat or Cool	0 - 90°F	6'	F	77
534277	L08Y-01	SPDT Heat or Cool	0 - 90°F	8'	F	90
Master Carton: 13.75" x 14" x 9", 12 Pcs, 18lbs.						

Electromechanical Humidistat



Features

- 4.4 amp @ 120VAC
- 2.2 amp @ 240VAC
- 50VA @ 24VAC - 240VAC
- 10% - 60% relative humidity range

Standard Models

UPC#	MODEL	DESCRIPTION	LIST
686334			
523370	H46D1214	Humidistat/Electromechanical	181

Electromechanical De-Humidistat



Features

- 4.4 amp @ 120VAC
- 2.2 amp @ 240VAC
- 50VA @ 24VAC - 240VAC
- 10% - 60% relative humidity range

Standard Models

UPC#	MODEL	DESCRIPTION	LIST
686334			
589147	H1D1AA	Dehumidistat/Electromechanical	69

Honeywell Line Voltage Thermostats



T4398A 1021
Precision Mechanical



Features

- Heat only thermostats
- Accurate temperature control
- 22 Amp resistive for mechanical models

Standard Models

UPC#	MODEL	VOLTAGE	DIMENSIONS	DESCRIPTION	LIST
686334					
503303	T4398A 1021	120-240	2.875"x4.375"x2.00D	Precision Electric Heating. SPST, 50-80 °F, 22 Amp @ 120-240V 19 Amp @ 277V	62



TL8230A 1003
Electronic Programmable



Features

- Heat only thermostats
- Accurate temperature control
- 16 Amp resistive for electronic models
- Energy Star compliant.

Standard Models

UPC#	MODEL	VOLTAGE	DIMENSIONS	DESCRIPTION	LIST
686334					
503365	TL8230A 1003	240/208	2.70"x4.90"x.90D	Electronic Programmable Line Voltage DPST, 15 Amp, 40-86 °F	179

Wireless RF Interface Series



RFT-1 shown with
UT thermostat

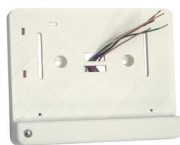

RFT-1



RFR-5

Features

- Heat only, Cool only
- 4 wire Heat/Cool
- Standard 2 stage Heat/ 1 Stage Cool Heat Pumps
- Multistage heating and/or cooling equipment
- Works with most low voltage thermostats
- Temp Range: 50-130 F
- Max Operating Range: 50 Feet

UPC#	MODEL	DESCRIPTION	VOLTAGE	CONNECTIONS	LIST
686334					
523554	RFT-1	RF Thermostat Transmitter Dim: 4" x 5" x .875"	2-AAA Batteries	6 Wires	100
523561	RFR-5	RF Relay Interface Dim: 4.5" x 6" x 1.25"	24 VAC	R-C-R1 1-2-3-4-5	100
523578	RKit-5	RFT-1 & RFR-5 Package	2 AAA 24 VAC	R-C-R1 1-2-3-4-5	200

Thermostats & Controls

Low Voltage Programmable Thermostats



TH115-A-024T

Features

- 7 Day, 4 Settings Per Day
- Control Accuracy +/- 1°F of Setpoint Temp
- Pre-Programmed or Custom Settings
- Backlit Display, Energy Star Compliant

Standard Models

UPC#	MODEL	DESCRIPTION	LIST
686334			
523400	TH115-A-024T	Heat Only Temp Range:40-86°F Dims:4.89"H x 2.79"W x .91"D	121

Features

- 7 Day, 4 Settings Per Day
- Control Accuracy +/- 1°F of Setpoint Temp
- Pre-Programmed or Custom Settings
- Backlit Display, Energy Star Compliant

Standard Models



TH147-P

UPC#	MODEL	DESCRIPTION	LIST
686334			
523585	TH147-P	7 Day, 4 Settings per Day, Heating/Cooling, 1 Stage Heat/Cool Temp Range Heat:41-82°F, Cool:59-95°F Dims: 5"W x 3"H x 1"D,	144

2 Stage Low Voltage Thermostat

Features

- 24V single or 2 stage heat and cool
- Gas, oil, or electric with air conditioning.
- Heat only, Heat only with fan, Cool only.
- Battery only, common wire only or common wire with battery backup.
- System settings - Heat, Off, Cool, Auto, Emergency Heat.
- Temperature range - Heat 40-90°F, Cool 50-99°F.
- Dimensions: 3-9/16" H x 5-13/16" W x 1-1/2" D

Standard Models



TW123

UPC#	MODEL	VOLTAGE	TEMP RANGE	MAX AMP	LIST
686334					
691116	TW123 / TH5220D	750MV - 2DV	40-90 Heat 50-99 Cool	1.0	337

Round - Low Voltage

Features

- Heat only for 24V heating systems
- Does not contain Mercury
- White color
- Temperature range - 50° - 90°F
- Dimensions 3-11/16" diameter

Standard Models



UPC#	MODEL	DESCRIPTION	VOLTAGE	MAX AMP	LIST
686334					
260008	A6176	Heat/Cool	24 VAC	1.0	88

UT Series - Low Voltage

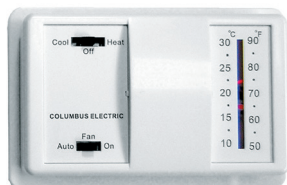
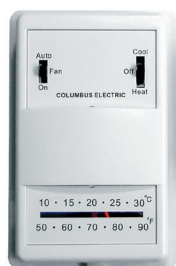

Features

- Vertical or horizontal mounting
- Long life sealed contacts
- Does not contain Mercury
- Leveling not required
- Fahrenheit and Celsius temperature scales
- 2-3°F rated differential
- Anticipator (except UT9001)

Standard Models

UPC# 686334	MODEL	DESCRIPTION	VOLTAGE	TERMINALS	SWITCHES	LIST
523059	UT1001	Heat Only	24VAC or MV	R & W	None	17.60
523066	UT3001	Cool Only	24 VAC	R, Y & G	Cool/Off Fan/Auto	18.15
523134	UT6001	Deadband	24 VAC	R, W & Y	None	19.25
523073	UT8001	Heat/Cool	24 VAC	RC, RH, W, Y, & G	Heat/Off/Cool Fan/Auto	19.25
523110	UT9001	Heat Only	Millivolt	R & W	None	17.60

Master Carton: 50 pcs, 17 lbs, 19" x 11.5" x 9"

RK Series - Low Voltage

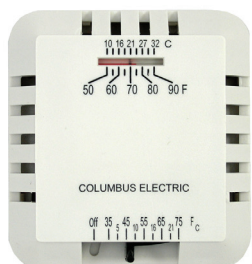

Features

- Heat only models
- Positive off
- Does not contain Mercury
- Leveling not required
- Long life sealed contacts
- Fahrenheit and Celsius temperature scales
- 2-3°F rated differential

Standard Models

UPC # 686334	MODEL	DESCRIPTION	VOLTAGE	RANGE	ANTICIPATOR	LIST
526012	RK120EAA	Heat Only	24VAC or MV	50°-90°F	Yes	17.60
526203	RK124EAA	Heat Only	24VAC or MV	35°-75°F	Yes	17.60
526050	RK130EAA	Heat Only	Millivolt	50°-90°F	No	14.85
526326	RK134EAA	Heat Only	Millivolt	35°-75°F	No	14.85
526142	RKWP1AA	Wall Plate	NA	NA	NA	3.85

Master Carton: 100 Pcs, 24 lbs, 16.5" x 15" x 8"

Low Voltage Relays

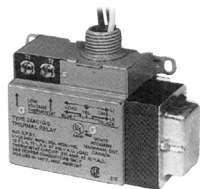

Two switch unit shown.

Features

- Snap action switch
- 1/2" male conduit spud
- 45 second average time delay
- Temperature range - 50° - 90°F
- Built-In transformer

Standard Models

UPC# 686334	MODEL	PRIMARY VOLTAGE	DESCRIPTION	LIST
260039	24A05A-1	120 Volts	Single Switch, single throw with In-Built Transformer for remote mounting or in a factory provided optional enclosure	179
260046	24A05E-1	208 Volts		
260053	24A01G-3	240 Volts		
260107	24A06G-1	240 Volts	Two switch, single throw with In-Built Transformer, 25 Amps per switch	264

TG Series Thermostat Guards



Features

- 8 tumbler locks

Standard Models

UPC# 686334	MODEL	DESCRIPTION	LIST
589123	TG1	Plastic Stat Guard/ 6.25" x 3.625" x 3.25" Opening	32
589109	TG1B	Metal Stat Guard/ 5.25" x 4.625" x 3" Opening	57
589130	TG2	Plastic Stat Guard/ 5.25" x 4.625" x 3.25" Opening	37
589161	TG2B	Metal Stat Guard/ 6.25" x 3.625" x 3.25" Opening	57
589116	TG3	Plastic Stat Guard/ 8.125" x 4.625" x 3.625" Opening	37
589178	TG3B	Metal Stat Guard/ 6.75" x 4.50" x 3.50" Opening	70
523615	TG4	Plastic Stat Guard / 3.50" x 3.937" x 1.75" Opening	37
523622	TG5	Plastic Stat Guard / 5" x 3.31" x 1.75" Opening	37
523639	TG6	Plastic Stat Guard / 5.75" x 4.625" x 1.75" Opening	37



Sizing formula for TAT Series heaters: 50 Watts of heat per square foot of heated space or 50W/sq ft.

Example: An 800 square foot structure will require 40,000 Watts of heat to obtain 150 degrees of prolonged heat to be effective. (800 sq ft x 50 Watts per square foot = 40,000 Watts of heat or 40KW of heat)

Product Features

- Heavy duty industrial construction
- Forward curved centrifugal blower
- High Temperature ball bearing motor
- Optional replaceable filter
- Single point power connection
- 24 volt control
- Heavy duty spiral finned elements constructed of stainless steel
- Safety devices include airflow switch, automatic limit control and manual reset limit control for secondary protection
- Disconnect switch and Unit Mounted Thermostat with range of up to 120 to 150 °F
- The "TAT" series is sold as a system that includes the base unit, three supplemental units and the remote timer/ temperature control (supplemental units may be purchased separately if necessary)

Product Specifications

APPLICATIONS:

- The "TAT" series is designed to heat small and mid-sized rooms up to 150 °F. This provides effective portable heating to areas infected with insects. It kills adult insects and will dehydrate larvae and eggs, making them unable to hatch. Although chemical sprays only target adult insects, they can be used before utilizing the "TAT" system in order to kill the adult insects.
- The system is designed to bring the temperature up to 150 °F in one hour or less, if all preliminary requirements are met.
- The "TAT" system may be used for water remediation, as well, in combination with adequate ventilation. Specific models for water remediation are also available.

TAT BASE UNIT:

- Heavy duty stainless steel spiral fin heating elements
- High temperature, ball bearing 1/3 HP - 1075 RPM blower motor
- Forward curved centrifugal blower-900 CFM of air output
- Safety devices include airflow switch, disconnect switch, automatic limit control and manual reset limit control for secondary protection
- 50 Amp unit may be linked to a 30 Amp unit to provide heating for larger spaces.
- Timer/Temp controller may be used to control both units but must use the 50 Amp base unit as the master.

SUPPLEMENTAL TAT CONVECTORS

- 3 convectors are an integral part of each TAT system
- 120 Volt, 15 Amp (Standard wall plug) - 5120 BTU size
- Supplied with 25' prewired cable that connects them to the TAT base unit control section with a three pin connector
- If used in front of windows or large glass doors, they will reduce heat loss and provide more even heating

TIMER/TEMPERATURE CONTROL UNIT

- Timer/Temp Controller is an integral part of the TAT system
- 24 Volt control device that controls the heat output of the TAT base unit and up to three TAT convectors for an operating range of 120 - 150 °F and for a time period of 1 -10 hours after the preset temperature is reached
- Supplied with a 25' prewired cable that connects to the TAT base unit control section using a four pin connector
- Mounts on Door outside the area being treated.
- LED lights will indicate when treatment is complete

Standard Models

UPC# 686334	STYLE MODEL NUMBER	BASE UNIT KW	BASEBOARD PERIMETER HEATER KW	TOTAL SYSTEM KW	BASE UNIT VOLTS	BASEBOARD PERIMETER HEATER VOLTS	PHASE	BASE UNIT AMP	BASEBOARD PERIMETER AMP-EACH CIRCUIT (3)	PLUG TYPE		LIST
										BASE UNIT	PERIMETER	
397568	TAT5-240-1/3BB/1T	5.3	1.5 (X3)	9.8	240	120	1	24	12.5	Nema 10-30	Nema 5-15	12,900
397629	TAT5-208-1/3BB/1T*	5.3	1.5 (x3)	9.8	208	120	1	27	12.5	----	Nema 5-15	12,900
397551	TAT8-240-1/3BB/1T	8.4	1.5 (X3)	12.9	240	120	1	37	12.5	Nema 14-50	Nema 5-15	13,500
397612	TAT8-208-1/3BB/1T*	8.4	1.5 (x3)	12.9	208	120	1	42	12.5	----	Nema 5-15	13,500
397520	TAT20-480-3/3BB/1T	20	1.5 (X3)	24.5	480	120	3	26	12.5	Nema L16-30	Nema 5-15	15,000
397582	TAT-ILC-25	25' Shielded Cable										250

*208 Volt models do not have a cord supplied

Accessories

UPC# 686334	MODEL	DESCRIPTION	HP	CFM / RPM	MAX AMPS	VOLTS	WT (LBS)	LIST
397636	TAT-24-FAN-120V-1	Thermal Area Treatment Floor Fan	1/3	5000/1160	3.1	120	30	325

UPC# 686334	MODEL	DESCRIPTION	KW	BTU	VOLTS	PHASE	AMPS	TEMP RISE	WT (LBS)	LIST
397834	TAT-30	30KW Salamander	30	102390	480	3	36	43	115	2537
397841	TAT-45	45KW Salamander	45	153585	480	3	54.2	70	125	4196

Product Dimensions

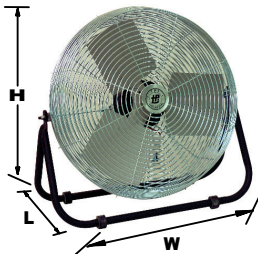
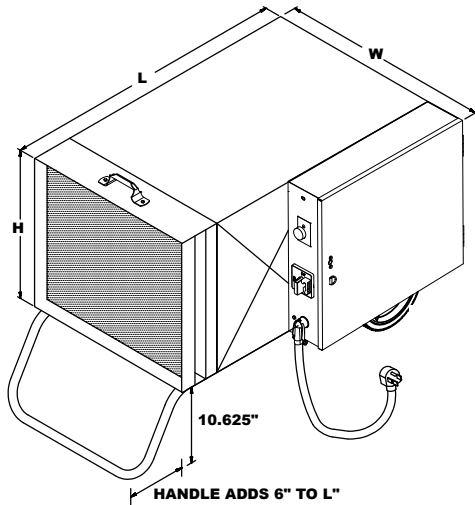

TAT-24-FAN-120V-1

- Single speed
- Head tilts 360°
- Coated steel guards
- SJT type 3 conductor
- Steel hub / Aluminum blades
- Meets OSHA standards

TAT 30-45

- Safety yellow heater enclosure with safety screens on both air intake and output openings.
- Optional 25' long SO type cord, ready for plug attachment is available for each model.
- Long-life finned tubular heating elements.
- Thermostat adjustment 120° to 150° F.
- Two 10" rear wheels and a front locking caster.
- High-limit thermal cutout switch with manual reset.
- 2200 CFM
- Fan only operation feature

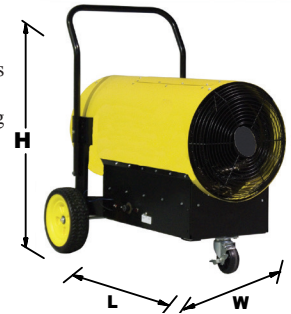

**CORD LENGTH: 25'
18AWG SHIELDED CABLE**

**CORD LENGTH: 6'10"
16AWG USASI HPN CORD**

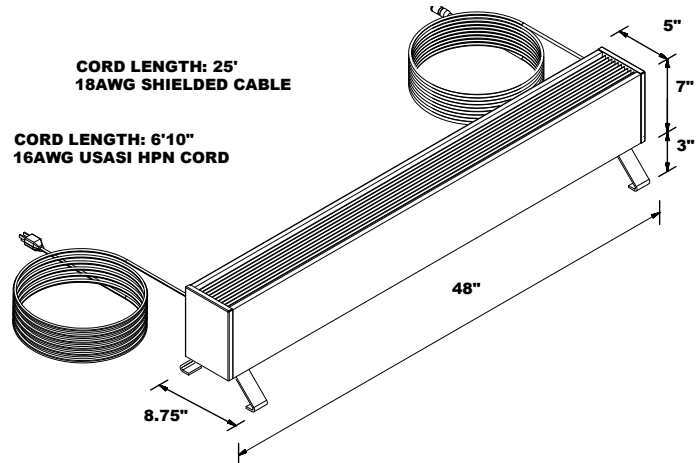

MODEL	DIMENSIONS			WT. (LBS)
	LENGTH	WIDTH	HEIGHT	
TAT-8-240-1	39"	26.5"	18"	180
TAT-5-240-1	39"	26.5"	18"	180
TAT-20-480-3	39"	30.5	18"	234
TAT-1-120-1	48"	8.5"	9.5"	23
Remote Timer	11"	3"	4.5"	5
TAT 30, 45	37"	24"	39"	115/125
TAT24-FAN-120V-1	10.5"	26"	26"	30

Thermal Area Treatment Heaters

How It Works:

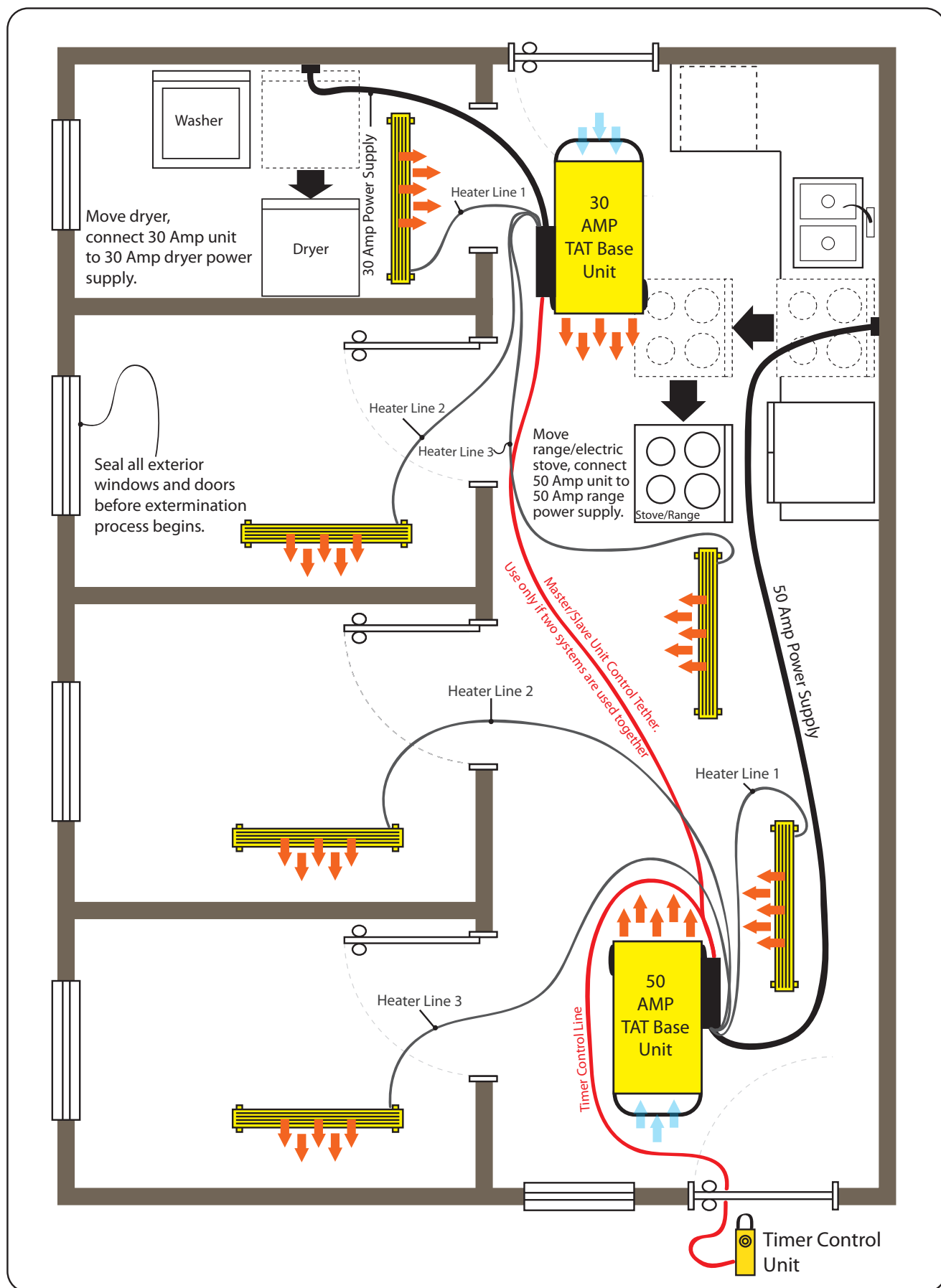
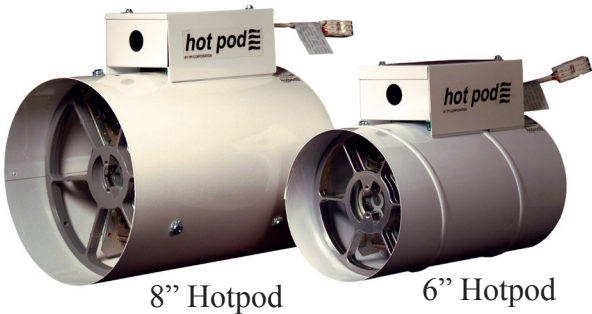

Diagram is for demonstrative purposes only and does not represent any actual structure or living environment. Two units may not be required for all situations, exterior climate, structure insulation, electrical service, and square footage all factor into effective treatment with this system.

Hotpod™ Supplemental Duct Mounted Heating System



8" Hotpod

6" Hotpod



Patented
Patent No. 8,285,127



HotPod - Features

- Use to heat cold rooms or additions without upgrading central system
 - Fan only operation for increased cfm output for A/C cycles
 - 6" 1000/500 Watt and 8" 1440/720 Watt models available
 - Two stage operation
 - 120V corded and hard wire models available
 - 10' Cord length on corded models
 - Zero clearance for all models
 - All models include UT8003 low voltage thermostat
 - Optional wireless thermostat
 - Silent boot option available for rigid duct applications
- Note: Silent Boot can only be used with rigid duct work

Standard HotPod Models

UPC#	MODEL	DESCRIPTION	WATTS	VOLTS	MIN.CIRC. SIZE (AMP)	TEMP RISE (F)	WT	RPM	CFM	NEMA PLUG	DIMENSION L X W X H	LIST
290074	HP6-1000120-2T	6" INLET, HARDWIRE	1000/500	120	8.33	26	4	1500	130	NA	10 1/2 x 8 1/2 x 6	513
290043	HP6-1000120-2CT	6" INLET, WITH CORD SET	1000/500	120	8.33	26	4	1500	130	5-15P	10 1/2 x 8 1/2 x 6	538
290081	HP8-1440120-2T	8" INLET, HARDWIRE	1440/720	120	12.6	23	6	1500	210	NA	11 x 10 1/2 x 8	625
290067	HP8-1440120-2CT	8" INLET, WITH CORD SET	1440/720	120	12.6	23	6	1500	210	5-15P	11 x 10 1/2 x 8	663

Multi-Pak Models - Includes 4 Hotpods

UPC#	MODEL	DESCRIPTION	WATTS	VOLTS	MIN.CIRC. SIZE (AMP)	TEMP RISE (F)	WT. LBS	RPM	CFM	NEMA PLUG	DIMENSION L X W X H	LIST
290036	HP6-1000120-2T	4 PACK 6" INLET, HARDWIRE	1000/500	120	8.33	26	16	1500	130	NA	10 1/2 x 17 x 12	2052
290111	HP6-1000120-2CT	4 PACK 6" INLET, WITH CORD SET	1000/500	120	8.33	26	16	1500	130	5-15P	10 1/2 x 17 x 12	2152
290050	HP8-1440120-2T	4 PACK 8" INLET, HARDWIRE	1440/720	120	12.6	23	25	1500	210	NA	10 1/2 x 20 x 16	2500
290128	HP8-1440120-2CT	4 PACK 8" INLET, WITH CORD SET	1440/720	120	12.6	23	25	1500	210	5-15P	10 1/2 x 20 x 16	2652
290333	HP6H-12PK*	12 PACK 6" INLET, HARDWIRE	1000/500	120	8.33	26	58	1500	130	NA	21 x 14 1/2 x 43	6156
290340	HP6C-12PK*	12 PACK 6" INLET, WITH CORD SET	1000/500	120	8.33	26	58	1500	130	5-15P	21 x 14 1/2 x 43	6456
290357	HP8H-12PK*	12 PACK 8" INLET, HARDWIRE	1440/720	120	12.6	23	82	1500	210	NA	27 1/4 x 14 1/2 x 52	7500
290364	HP8C-12PK*	12 PACK 8" INLET, WITH CORD SET	1440/720	120	12.6	23	82	1500	210	5-15P	27 1/4 x 14 1/2 x 52	7956

*includes 1 HotPod display

Note: Multi-Pak specifications (watts, volts, etc) are for each individual hotpod in the pack excluding weight.

Silent Booster™ Supplemental Duct Mounted Boosting System

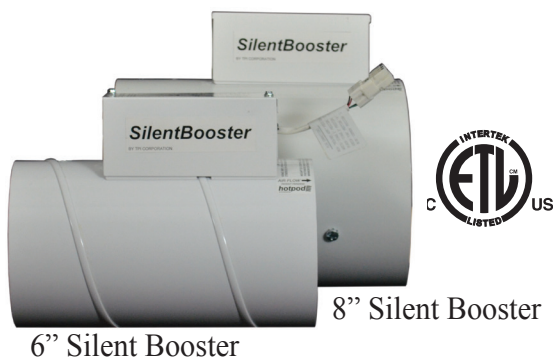

6" Silent Booster

8" Silent Booster



Silent Booster - Features

- 120V corded and hardwire models available
- Adds 120 CFM Boost to duct heating or ventilation applications
- Can utilize optional TPI SilentBoot™ for whisper quiet operation in rigid duct application.
- 14" of duct, 4" from register is all that is needed for installation
- Optional wireless thermostat can be utilized to control Silent Booster™ to increase room comfort

Moisture Control System - Features

- 120V, 8" Ducted Booster Fan; De-humidistat included
- 6" to 8" adapters available
- Includes all ductwork and outside damper
- Uses Heavy Duty booster fan to eliminate humidity from basements, crawl spaces, or damp areas.

Standard Silent Booster Models

UPC#	MODEL	DESCRIPTION	VOLTS	MIN.CIRC. SIZE (AMP)	WT	RPM	CFM	NEMA PLUG	DIMENSION L X W X H	LIST
290371	SB6-120-T	6" SILENT BOOSTER (Hardwire)	120	15	4	1500	130	NA	10 1/2 x 8 1/2 x 6	225
290388	SB6-120-CT	6" SILENT BOOSTER (w/Cord Set)	120	15	4	1500	130	5-15P	10 1/2 x 8 1/2 x 6	250
290395	SB8-120-T	8" SILENT BOOSTER (Hardwire)	120	15	4	1500	210	NA	11 x 10 1/2 x 8	250
290401	SB8-120-CT	8" SILENT BOOSTER (w/Cord Set)	120	15	4	1500	210	5-15P	11 x 10 1/2 x 8	275
MOISTURE CONTROL SYSTEM										
290418	MCS120-8CT	8" MOISTURE CONTROL SYSTEM	120	15	4	1500	210	5-15P	11 x 10 1/2 x 8	350

Hotpod Accessories And Thermostat

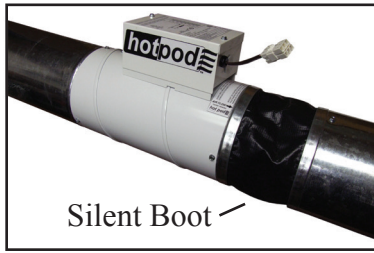

Silent Boot

UPC#	MODEL	DESCRIPTION	WT	LIST
686334				
290098	SB-6*	6" SILENT BOOT	4	37.50
290104	SB-8*	8" SILENT BOOT	4	62.50
523578	RFKIT-5	WIRELESS TRANSMITTER	6	200

* Can be used with Hotpod models as a noise attenuator

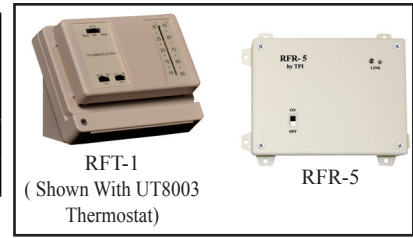

RFT-1
(Shown With UT8003
Thermostat)

RFR-5

RFKIT-5 - Patent Pending

Hotpod Ready-Pack Self Contained Systems



Ready-Pack self contained system
Note: does not mount to existing duct work.

Features

- Includes all you need to install a complete Hotpod system
- Ideal for room or office additions
- RF Thermostat is standard with our Ready-Pack models, simplifying installation even further - Eliminates the need for thermostat wiring.
- Same specifications for 6" and 8" Hotpod models apply to Ready-Pack models.

What's Included

- 6" or 8" Hotpod with RFKIT-5 wireless thermostat and transmitter
- One outlet and one return air grill
- Two 90 degree elbows
- Flexible duct (12.5')
- 8" models include 2 reducers - 8" to 6"

MODEL	DESCRIPTION	LIST
HP6-1000120-2TRP	6" INLET, 1000W, 120V, READY-PACK	1137
HP6-1000120-2CTRP	6" INLET, 1000W, 120V, READY-PACK WITH CORDSET	1200
HP8-1440120-2TRP	8" INLET, 1440W, 120V, READY-PACK	1350
HP8-1440120-2CTRP	8" INLET, 1440W, 120V, READY-PACK WITH CORDSET	1390

MFH Series Hotpod - For those LARGER areas



Features

- When the standard Hotpod is not enough
- 240V model has 6' cord set with a NEMA-6-15P Plug
- Unit contains air flow switch
- Zero inch (0") clearance installation
- All units are shipped with our UT8003 low voltage thermostat
- All units obtain a 33 degree temperature rise
- RP models are Ready-Pack models and do not need existing duct work

Standard Models

UPC#	MODEL	DESCRIPTION	WATTS	VOLTS	WT	CFM	RPM	LIST
686334								
290135	MFHE-0300-6-EAA	6" INLETS, 1500 W, 120V,2 STAGE THERMOSTAT	1500	120	132	250	1500	1300
290197	MFHE-0300-6-EAARP	UNIT ABOVE WITH FLEX, BOOTS, GRILLS	1500	120	145	250	1500	1738
290142	MFHE-0300-6-EAAC	6" INLETS, 1500 W, 120V,2 STAGE THERMOSTAT, CORD	1500	120	132	250	1500	1338
290203	MFHE-0300-6-EAACRP	UNIT ABOVE WITH FLEX, BOOTS, GRILLS	1500	120	145	250	1500	1775
290173	MFHE-0300-6-HAA	6" INLETS, 2000W, 240V, 2 STAGE THERMOSTAT	2000	240	132	250	1500	1375
290234	MFHE-0300-6-HAARP	UNIT ABOVE WITH FLEX, BOOTS, GRILLS	2000	240	145	250	1500	1812
290159	MFHE-0300-8-EAA	8" INLETS, 1500W, 120V, 2 STAGE THERMOSTAT	1500	120	135	250	1500	1325
290210	MFHE-0300-8-EAARP	UNIT ABOVE WITH FLEX, BOOTS, GRILLS, REDUCERS	1500	120	148	250	1500	1862
290166	MFHE-0300-8-EAAC	8" INLETS, 1500W, 120V, 2 STAGE THERMOSTAT,CORD	1500	120	135	250	1500	1362
290227	MFHE-0300-8-EAACRP	UNIT ABOVE WITH FLEX, BOOTS, GRILLS, REDUCERS	1500	120	148	250	1500	1900
290180	MFHE-0300-8-HAA	8" INLETS, 3000W, 240V, 2 STAGE THERMOSTAT	3000	240	135	250	1500	1412
290241	MFHE-0300-8-HAARP	UNIT ABOVE WITH FLEX, BOOTS, GRILLS, REDUCERS	3000	240	148	250	1500	1950

Fresh Air Make Up Units - Features

- Can be used with existing systems for fresh air intake
- Includes replaceable filter
- All units include duct stat and disconnect switch
- Available with 6" inlet and outlet only

Standard Models

UPC#	MODEL	DESCRIPTION	CFM	RPM	LIST
686334					
290258	MFHE-0300-6-HAAF2D	6" INLETS, 3000W, 240V, FILTER, DUCT STAT	250	1500	1750
290265	MFHE-0300-6-FAAF2D	6" INLETS, 2000W, 208V, FILTER, DUCT STAT	250	1500	1700

7200 Series Plenum Heater

Product Dimensions

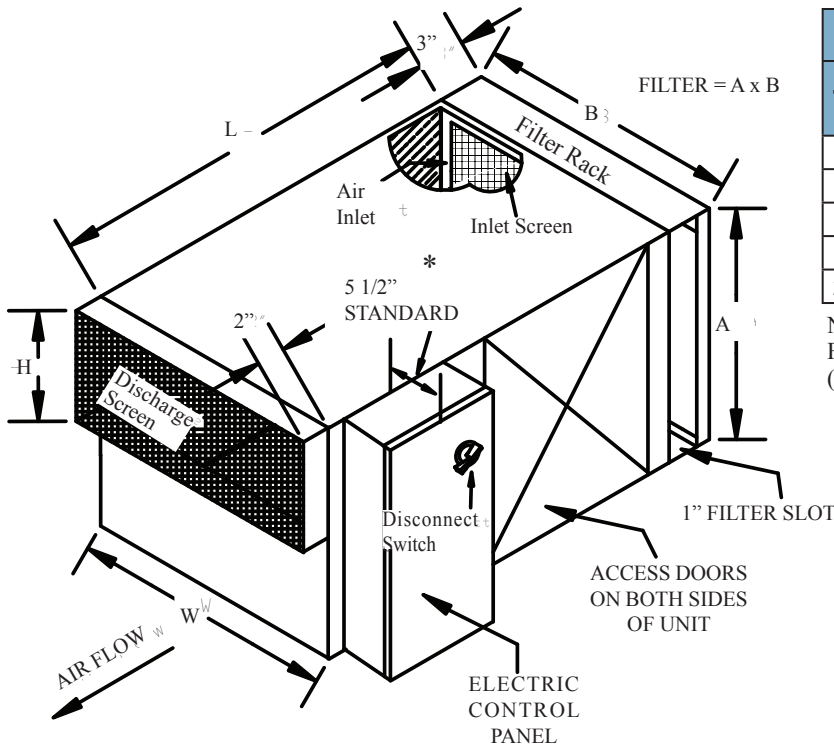

DIMENSIONS					
7200 Series	A	B	L	DISCHARGE	
				W	H
3 KW	12"	14"	28"	14"	8"
5 KW	14"	18"	36"	18"	8"
10 & 15 KW	18"	18"	36"	18"	10"
20 KW	18"	22"	36"	22"	10"
23 & 25 KW	18"	26"	36"	26"	10"

Note: Control panel access standard as shown. For panel on opposite side access specify and order (Figure 5).

* Control box depth depends on actual components. Consult factory for exact dimensions.

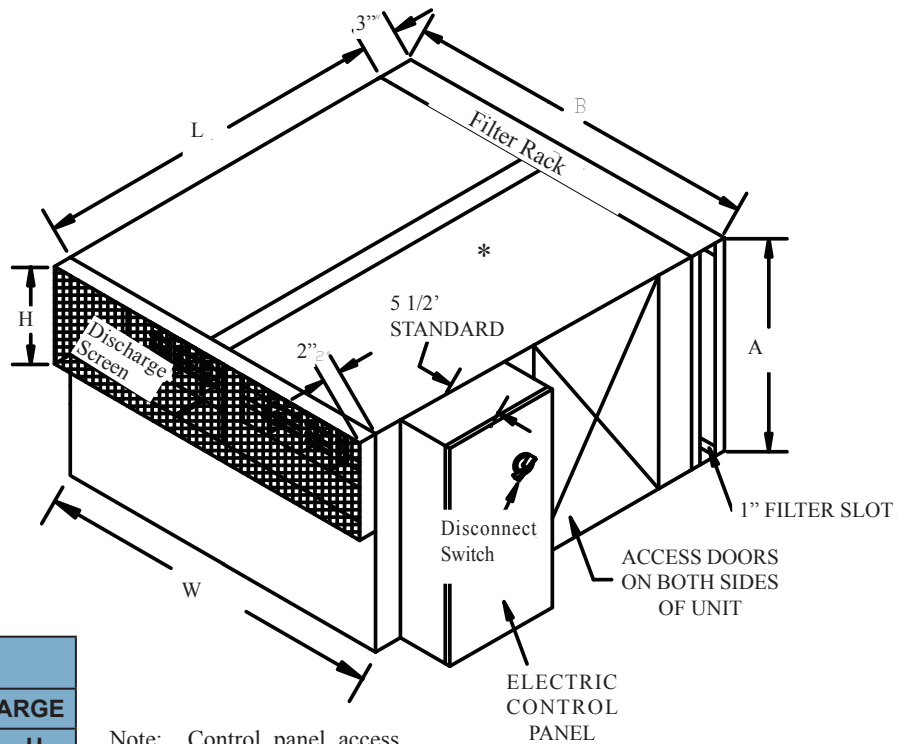

DIMENSIONS					
7200 Series	A	B	L	DISCHARGE	
				W	H
25-30-35 KW	18"	44"	36"	44"	10"
40-45-50 KW	18"	52"	36"	52"	10"

Note: Control panel access standard as shown. For panel on opposite side access specify and order (Figure 5).

7300 Series Plenum Heater

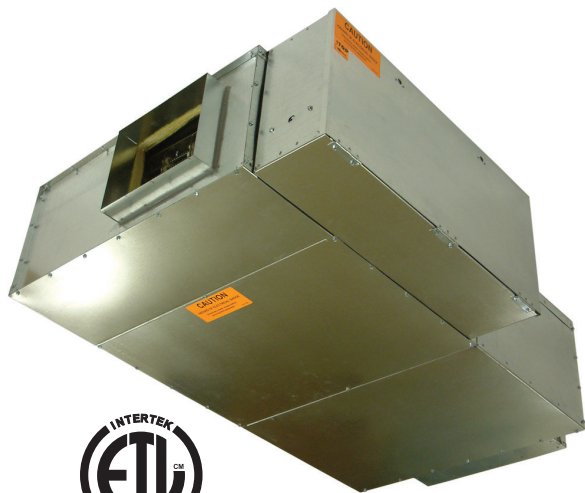

Manufactured in U.S.A.

HOW TO DESIGNATE A MODEL:

F	3	E	73	15	2	T
Element Voltage F = 208V H = 240V G = 277V P = 480V	Phase 1 = Single Phase 3 = Three Phase	Motor Voltage E = 120 G = 277 P = 480	Series Number	Element KW 3KW through 18KW See model chart for KW options.	Heater Stages Blank = One 2 = Two	Control System T = Unit Thermostat SSR = SSR Control Blank = None

The 7300 Series LowBoy Plenum Heater is designed to fit jobs where the clear space between the ceiling and the floor above is as small as 11-3/4 inches.

Product Specifications

- 20 gauge galvanized cabinet.
- Variable speed motor, factory set at maximum. Motor speed can be field adjusted to increase heat rise.
- Acoustically insulated with 1" fiberglass.
- Access panels on bottom of unit.
- 24 Volt controls.
- Air flow switch.
- Terminal blocks.
- Single point connection.
- Dust tight control enclosure.
- Filter rack on inlet with throw away filter.
- Inlet and outlet screens and duct connection.
- Automatic primary limit control.
- Optional wall thermostat, unit thermostat or SSR control which proportionally regulates heat output.
- Disconnect switch.

Standard Models

UPC# 686334	MODEL	KW	CFM RANGE	VOLTS/ PHASE	TOTAL AMPS for MOTOR & HEATER	STAGE	MOTOR VOLTAGE	FULL LOAD AMPS for MOTOR ONLY	MOTOR H.P.	WT. (LBS)	LIST PRICE
618076	F1G7305	5	170-950	208/1	26	1	277	2	1/4	163	1700
617543	H1G7305			240/1	22						
606301	G1G7305			277/1	20						
617642	F3G7305			208/3	15		277	2			
534451	H3G7305			240/3	14						
606455	P3G7305			480/3	8						
609968	F3E7310	10	170-950	208/3	32	1	120	4	1/4	163	1950
617734	H3G7310			240/3	26		277	2			
617598	P3G7310			480/3	14		277	2			
606363	F3E7310-2			208/3	32		2	2			
534468	H3G7310-2			240/3	26						
617697	P3G7310-2			480/3	14						
534482	H3G7312	12	170-950	240/3	32	1	277	3	1/4	163	2500
534499	P3G7312			480/3	17		277	3			
608596	F3E7312-2			208/3	41		2	2			
534505	H3G7312-2			240/3	32						
617703	P3G7312-2			480/3	17						
534529	H3G7315			15	270-1500		240/3	39			
608725	P3G7315	480/3	21			277	3				
618106	F3E7315-2	208/3	49			2	2				
608510	H3G7315-2	240/3	39								
617536	P3G7315-2	480/3	21								
608763	P3G7318	18	270-1500			480/3	25	1	277	3	2750
606189	P3G7318-2			480/3	25	2	277		3	2800	

7300 Series Plenum Heater

Product Dimensions

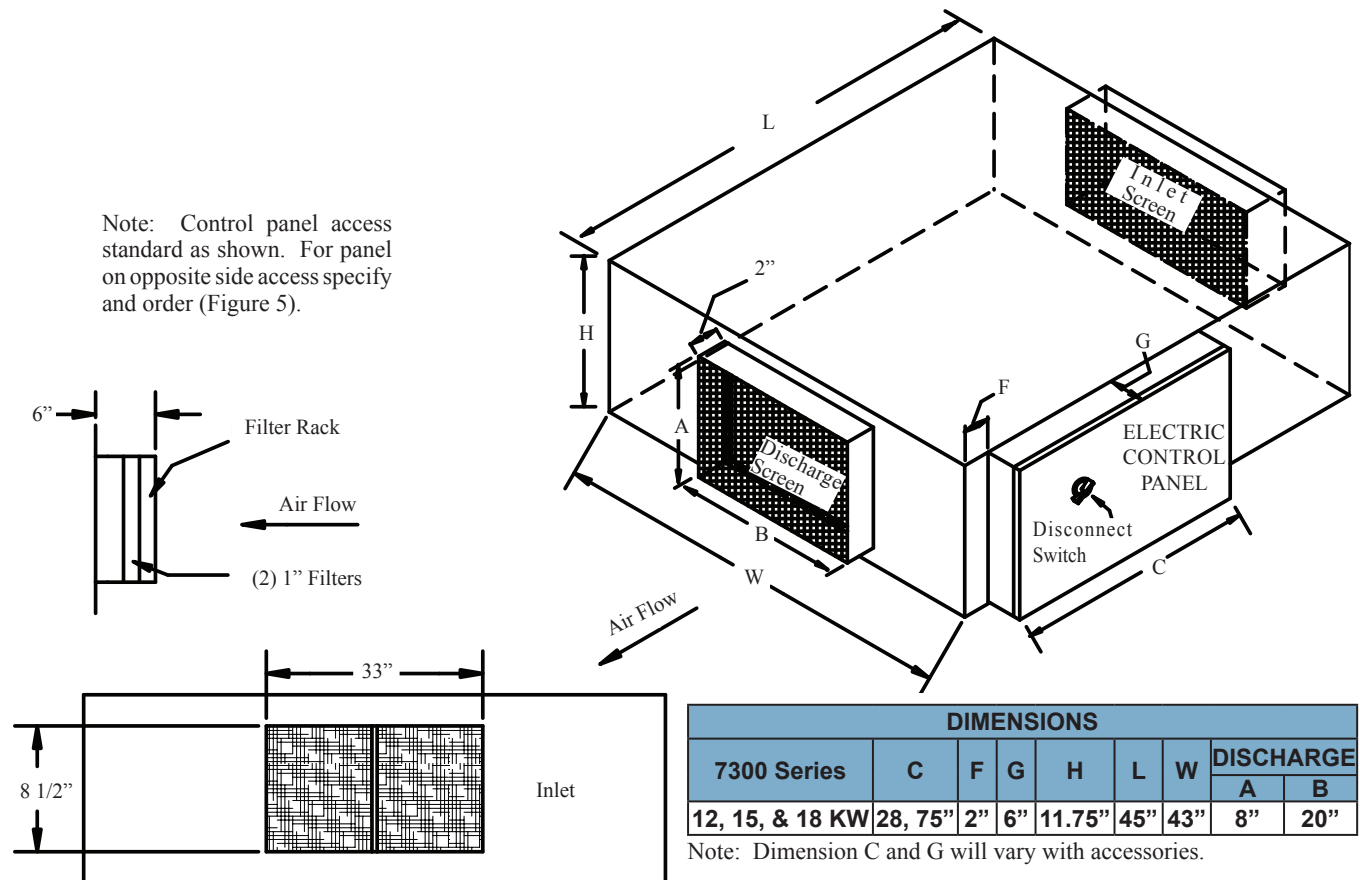
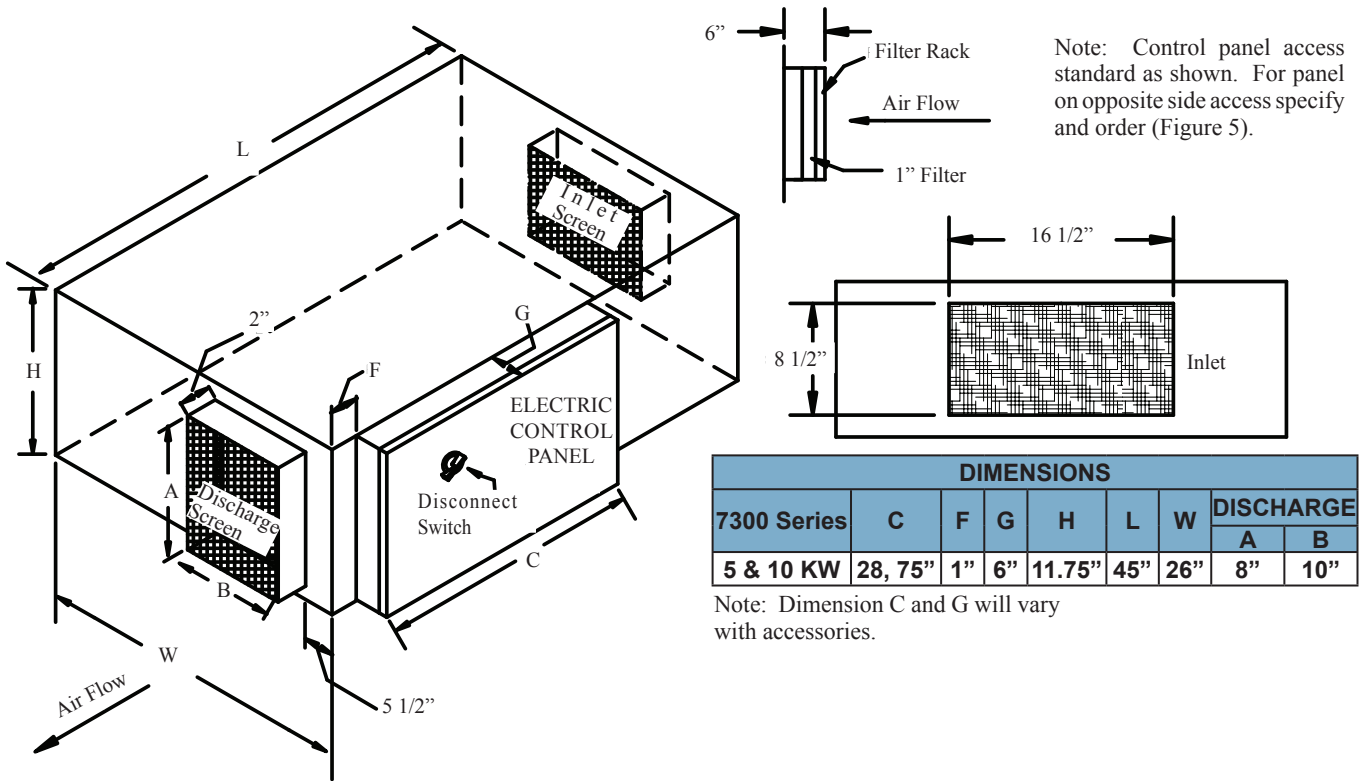

PD Series Packaged Duct Heater

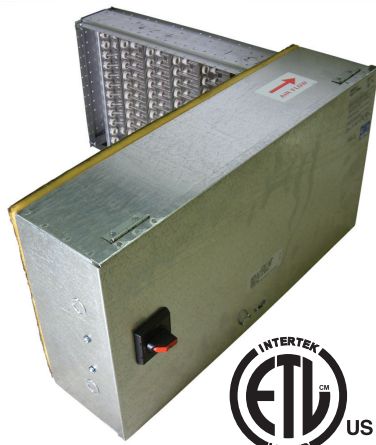

Manufactured in U.S.A.

Standard Features

- Galvanized Steel Element Rack - Always 1” shorter than duct height and 1/2” shorter than duct width to allow insertion clearance
- Galvanized Steel Compartment with 1/2” fiberglass Insulation & Hinged Cover
- Door Interlock Disconnect Switch
- Primary Automatic Reset Temp Limiting Control
- Load Carrying Secondary over Temperature Protective Device(s)
- Definite Purpose Magnetic Contactor(s)
- Differential Pressure Fan Inter-lock Switch
- Step Down Control Transformer / 24 Volt
- Permanently Attached Wiring Diagram on inside of Terminal Compartment Cover

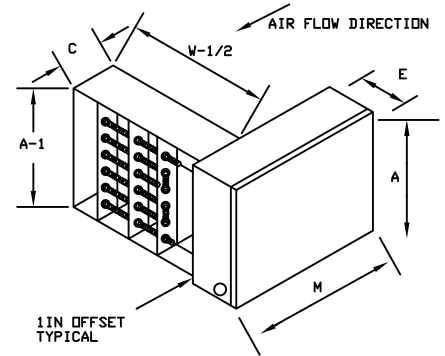

Standard Models

UPC 686334	MODEL NUMBER	KW	POWER VOLTS/ PHASE	DUCT WIDTH W	DUCT HEIGHT A	DIMENSIONS			AMPS	CONTROL STEPS	WT. (LBS.)	LIST	
						C	E	M					
617000	PD5-128-1	5	240-1	12	8	4.75	6.5	26	20.9	1	22	779	
617017	PD10-1810-1	10		18	10	4.75	6.5	28	41.7	2	37	1045	
617024	PD15-1812-1	15		18	12	4.75	6.5	27	62.5	2	33	1224	
617031	PD20-2012-1	20		20	12	9.125	7.5	31	83.3	2	37	1535	
617048	PD25-2016-1	25		20	16	9.125	7.5	38	104.2	3	56	2447	
617055	7PD2-128-1	2	277-1	12	8	4.75	6.5	26	7.2	1	21	779	
617062	7PD3.5-128-1	3.5							12.6			801	
617079	7PD5-128-1	5							18.1			1028	
617086	8PD5-128-3	5	208-3	12	8	4.75	6.5	26	13.9	1	22	899	
617093	8PD10-1810-3	10		18	10	4.75	6.5	22	27.8	1	27	918	
617109	8PD15-1812-3	15		18	12	9.125	6.5	25	41.7	1	32	1068	
617116	8PD15-1812-2-3	15		18	12	9.125	6.5	28	41.7	2	34	1123	
617123	8PD20-2012-3	20		20	12	9.125	6.5	40	55.6	2	39	1358	
617130	8PD25-2016-3	25		20	16	9.125	6.5	29	69.5	2	58	1368	
617147	8PD30-2416-2-3	30		24	16	9.125	7.5	29	83.4	2	65	1947	
617154	8PD30-2416-3	30		24	16	9.125	7.5	35	83.4	3	60	1980	
617437	8PD35-2416-3	35		24	16	9.125	7.5	35	97.3	3	65	2114	
617321	8PD40-2416-3	40		24	16	9.125	7.5	43	111.2	3	75	2670	
617338	8PD45-3016-3	45		30	16	9.125	7.5	43	125.1	3	80	2726	
617345	8PD50-3016-3	50		30	16	9.125	7.5	43	139	3	85	2781	
617161	PD-128-3	5		240-3	12	8	4.75	6.5	26	12.1	1	21	756
617178	PD10-1812-3	10			18	10	4.75	6.5	22	24.1	1	26	835
617185	PD15-1812-1-3	15			18	12	4.75	6.5	20	36.2	1	30	934
617192	PD15-1812-2-3	15	18		12	9.125	6.5	26	36.2	2	33	957	
617208	PD20-2012-3	19.9	20		12	9.125	6.5	28	47.9	2	39	1224	
617215	PD25-2016-3	25	20		16	9.125	6.5	29	60.2	2	57	1368	
617222	PD30-2416-2-3	30	24		16	4.75	6.5	25	72.3	2	57	1513	
617239	PD30-2416-3-3	30	24		16	9.125	6.5	35	72.3	3	65	1580	
617352	PD35-2416-3	35	24		16	9.125	7.5	35	84.3	3	65	1757	
617369	PD40-2416-3	40	24		16	9.125	7.5	35	96.3	3	75	2025	
617376	PD45-3016-3	45	30		16	9.125	7.5	43	108.4	3	80	2625	
617383	PD50-3016-3	49.8	30		16	9.125	7.5	43	120	3	85	2737	
617246	4PD5-128-3	5	480-3		12	8	4.75	6.5	26	6.1	1	21	867
617253	4PD10-1810-3	10			18	10	4.75	6.5	22	12.1	1	26	918
617260	4PD15-1812-3	15			18	12	4.75	6.5	20	18.1	1	30	968
617277	4PD15-1812-2-3	15		18	12	9.125	6.5	26	18.1	2	34	1112	
617284	4PD20-2012-3	20		20	12	9.125	6.5	26	24.1	2	39	1135	
617291	4PD25-2016-3	25		20	16	9.125	6.5	22	30.1	2	58	1169	
617307	4PD30-2416-2-3	30		24	16	4.75	6.5	18	36.2	2	65	1201	
617314	4PD30-2416-3-3	30		24	16	9.125	6.5	24	36.2	3	65	1268	
617390	4PD35-2416-3	35		24	16	9.125	6.5	26	42.2	3	65	1624	
617406	4PD40-2416-3	39.9		24	16	9.125	6.5	40	48.1	3	75	1836	
617420	4PD50-3016-3	50		30	16	9.125	6.5	36	60.2	3	85	2225	

<i>Model</i>	<i>Page</i>	<i>Model</i>	<i>Page</i>	<i>Model</i>	<i>Page</i>	<i>Model</i>	<i>Page</i>
2605	20	91120	56	222-A30-TH-277V	68	30R	34
2607	20	93108	58	222-A30-TH-480V	68	30R2	34
2610	20	93120	58	222-A30-THSS-208V	68	30R7	34
2615	20	316422	76	222-A30-THSS-240V	68	30R8	34
2620	20	880435	76	222-A30-THSS-277V	68	32T1	46
2625	20	880435	76	222-A30-THSS-480V	68	32T2	46
2630	20	880442	76	222-A60-TH-208V	68	3310EX33R	45
2640	20	880459	76	222-A60-TH-240V	68	3310EX33WR	45
2650	20	880466	76	222-A60-TH-277V	68	3320EX16	40
8510	28	880466	76	222-A60-TH-480V	68	3320EX33	40
8512	28	880497	76	222-A60-THSS-208V	68	3380EX33	34
8513	28	880497	76	222-A60-THSS-240V	68	342-30-TH-208V	68
8514	28	880510	76	222-A60-THSS-277V	68	342-30-TH-240V	68
8515	28	880527	76	222-A60-THSS-480V	68	342-30-TH-480V	68
8516	28	31939009	69	223-30-TH-208V	69	342-30-THSS-208V	68
8517	28	31940009	69	223-30-TH-240V	69	342-30-THSS-240V	68
8518	28	31941009	69	223-30-TH-277V	69	342-30-THSS-480V	68
8519	28	A1560	80	223-30-TH-480V	69	342-60-TH-208V	68
8520	28	DBTS IECR	62	223-30-THSS-208V	69	342-60-TH-240V	68
8522	28	170-TS	79	223-30-THSS-240V	69	342-60-TH-480V	68
8523	28	178 TMC	79	223-30-THSS-277V	69	342-60-THSS-208V	68
8524	28	188 TASA	79	223-30-THSS-480V	69	342-60-THSS-240V	68
8525	28	18D-2-30CF	74	223-60-TH-208V	69	342-60-THSS-480V	68
8526	28	18D-2-80CF	74	223-60-TH-240V	69	342-90-TH-208V	68
8527	28	198 TMC	79	223-60-TH-277V	69	342-90-TH-240V	68
8528	28	222-30-TH-208V	68	223-60-TH-480V	69	342-90-TH-480V	68
8529	28	222-30-TH-240V	68	223-60-THSS-208V	69	342-90-THSS-208V	68
8530	28	222-30-TH-277V	68	223-60-THSS-240V	69	342-90-THSS-240V	68
8532	28	222-30-TH-480V	68	223-60-THSS-277V	69	342-90-THSS-480V	68
8533	28	222-30-THSS-208V	68	223-60-THSS-480V	69	342-A30-TH-208V	68
8534	28	222-30-THSS-240V	68	223-90-TH-208V	69	342-A30-TH-240V	68
8535	28	222-30-THSS-277V	68	223-90-TH-240V	69	342-A30-TH-480V	68
8536	28	222-30-THSS-480V	68	223-90-TH-277V	69	342-A30-THSS-208V	68
8537	28	222-60-TH-208V	68	223-90-TH-480V	69	342-A30-THSS-240V	68
8538	28	222-60-TH-240V	68	223-90-THSS-208V	69	342-A30-THSS-480V	68
8539	28	222-60-TH-277V	68	223-90-THSS-240V	69	342-A60-TH-208V	68
9128	56	222-60-TH-480V	68	223-90-THSS-277V	69	342-A60-TH-240V	68
9136	56	222-60-THSS-208V	68	223-90-THSS-480V	69	342-A60-TH-480V	68
9148	56	222-60-THSS-240V	68	24A01G-3	87	342-A60-THSS-208V	68
9160	56	222-60-THSS-277V	68	24A05A-1	87	342-A60-THSS-240V	68
9172	56	222-60-THSS-480V	68	24A05E-1	87	342-A60-THSS-480V	68
9184	56	222-90-TH-208V	68	24A06G-1	87	343-30-TH-208V	69
9196	56	222-90-TH-240V	68	303EX16RW	34	343-30-TH-240V	69
9328	58	222-90-TH-277V	68	303EX16RW	46	343-30-TH-480V	69
9336	58	222-90-TH-480V	68	303EX32RW	34	343-30-THSS-208V	69
9348	58	222-90-THSS-208V	68	303EX32RW	46	343-30-THSS-240V	69
9360	58	222-90-THSS-240V	68	303EX8RW	34	343-30-THSS-480V	69
9372	58	222-90-THSS-277V	68	303EX8RW	46	343-60-TH-208V	69
9384	58	222-90-THSS-480V	68	305EX16	39	343-60-TH-240V	69
9396	58	222-A30-TH-208V	68	305EX32	39	343-60-TH-480V	69
91108	56	222-A30-TH-240V	68	305EX8	39	343-60-THSS-208V	69

Product Index Listing

Model	Page	Model	Page	Model	Page	Model	Page
343-60-THSS-240V	69	4300EX8	47	630-25279	73	671-5018	73
343-60-THSS-480V	69	4300EX8W	47	630-25489	73	671-5056	73
343-90-TH-208V	69	4300EX8W	48	630-36489	73	671-5057	73
343-90-TH-240V	69	4300P	47	630-38579	73	671-5058	73
343-90-TH-480V	69	4300PB	40	631-16249	73	671-5059	73
343-90-THSS-208V	69	4300PW	47	631-25489	73	671-5060	73
343-90-THSS-240V	69	4300PW	48	631-25609	73	671-5061	73
343-90-THSS-480V	69	43T	47	631-38579	73	7PD2-812-1	97
3900AC	51	43T	48	632-1620	69	7PD3.5-812-1	97
3900ACC	51	43T2	47	632-1620	73	7PD5-812-1	97
3900-CS	51	4400EX16	40	632-1624	69	8PD10-1018-3	97
3900-CSC	51	4400EX32	40	632-1624	73	8PD15-1218-2-3	97
3900DS	51	4400EX8	40	632-2548	69	8PD15-1218-3	97
3900DSC	51	462-30-TH-480V	68	632-2548	73	8PD20-1220-3	97
3900-ICS	51	462-30-THSS-480V	68	6333D052033B30D0F	25	8PD25-1620-3	97
3900-ICSC	51	462-60-TH-480V	68	6333D052433B30D0F	25	8PD30-1624-2-3	97
3900-OCS	51	462-60-THSS-480V	68	6333D053834B30D0F1	25	8PD30-1624-3	97
3900-OCSC	51	462-90-TH-480V	68	6333D054134B30D0F1	25	8PD35-1624-3	97
3900REC	51	462-90-THSS-480V	68	6333D054833B30D0F	25	8PD40-1624-3	97
3900RECC	51	462-A30-TH-480V	68	6333D103834B30D0F1	25	8PD45-1630-3	97
3900T1	51	462-A30-THSS-480V	68	6333D104134B30D0F1	25	8PD50-1630-3	97
3900T1C	51	462-A60-TH-480V	68	6346D102033B30D0F	25	8PD5-812-3	97
3900T2	51	462-A60-THSS-480V	68	6346D102433B30D0F	25	9100EC	56
3900T2C	51	463-30-TH-480V	69	6346D104833B30D0F	25	9100IC	56
3900WW120	51	463-30-THSS-480V	69	641-35611	73	9100OC	56
3900WW28	51	463-60-TH-480V	69	641-35621	73	91BS012	56
3900WW36	51	463-60-THSS-480V	69	641-35631	73	91BS024	56
3900WW48	51	463-90-TH-480V	69	641-35641	73	91BS036	56
3900WW60	51	463-90-THSS-480V	69	641-35661	73	91BS048	56
3900WW72	51	483 TM	79	641-36051	73	91BS060	56
3900WW96	51	48T2	48	641-36061	73	91BS072	56
39BS120	51	4PD10-1018-3	97	641-36071	73	91BS084	56
39BS120C	51	4PD15-1218-2-3	97	641-37211	73	91BS096	56
39BS28	51	4PD15-1218-3	97	641-50011	73	91BS108	56
39BS28C	51	4PD20-1220-3	97	641-50021	73	91BS120	56
39BS36	51	4PD25-1620-3	97	641-70001	73	9300EC	58
39BS36C	51	4PD30-1624-2-3	97	641-70011	73	9300IC	58
39BS48	51	4PD30-1624-3-3	97	641-70021	73	9300OC	58
39BS48C	51	4PD35-1624-3	97	641-70031	73	93BS012	58
39BS60	51	4PD40-1624-3	97	641-70041	73	93BS024	58
39BS60C	51	4PD50-1630-3	97	641-70241	73	93BS036	58
39BS72	51	4PD5-812-3	97	641-70251	73	93BS048	58
39BS72C	51	630-05129	73	641-70261	73	93BS060	58
39BS96	51	630-10209	73	641-70271	73	93BS072	58
39BS96C	51	630-10249	73	641-70281	73	93BS084	58
4300EX16	47	630-16209	73	641-70321	73	93BS096	58
4300EX16W	47	630-16249	73	671-3454	73	93BS108	58
4300EX16W	48	630-16279	73	671-3492	73	93BS120	58
4300EX32	47	630-16489	73	671-3784	73	A1600	22
4300EX32W	47	630-25209	73	671-3785	73	A1601	22
4300EX32W	48	630-25249	73	671-3786	73	A5105	15

<i>Model</i>	<i>Page</i>	<i>Model</i>	<i>Page</i>	<i>Model</i>	<i>Page</i>	<i>Model</i>	<i>Page</i>
A51100	18	B5150	15	CB-300BS	63	CSW	55
A5120	15	B5175	18	CB-4	63	CTBDB	55
A5150	15	BBS024A	55	CB-400BS	63	CTBDB	55
A5175	18	BBS024AW	55	CB-5	63	CTBDB-TP	55
A5520/UHB	10	BBS024C	55	CB-500BS	63	CTBDW	55
A6176	17	BBS028A	55	CB-6	63	CTBSB	55
A6176	86	BBS028AW	55	CB-600BS	63	CTBSB	55
AD5120	15	BBS028C	55	CB-7	63	CTBSB-TP	55
AD5120	15	BBS036A	55	CB-700BS	63	CTBSW	55
AD5150	15	BBS036AW	55	CB-8	63	CV10012X	38
AD5150	15	BBS036C	55	CB-800BS	63	CV10022Xi	38
AD5175	15	BBS040A	55	CB-9	63	CV10027X	38
AET5DWS	83	BBS040AW	55	CB-900BS	63	CV100X	38
AET5SWS	83	BBS040C	55	CF36	82	CV100Xi	38
AF3401-24	36	BBS048A	55	CF48	82	CV100YX	38
AF3402-24	36	BBS048AW	55	CF60	82	CV11012X	38
AF3403-24	36	BBS048C	55	CFHD36	82	CV11022Xi	38
AG3401-24	36	BBS060A	55	CFHD48	82	CV11027X	38
AG3402-24	36	BBS060AW	55	CFHD60	82	CV110X	38
AG3403-24	36	BBS060C	55	CH-2212-1C	77	CV110Xi	38
AH3401-24	36	BBS072A	55	CH-6424-1C	77	CV110YX	38
AH3402-24	36	BBS072AW	55	CHWG-222	69	CV12512X	38
AH3403-24	36	BBS072C	55	CHWG-223	69	CV12522Xi	38
APS-3C	74	BBS084A	55	CHWG-342	69	CV12527X	38
ASHDB ECL	63	BBS084AW	55	CHWG-343	69	CV125X	38
ASHDB ECR	63	BBS084C	55	CHWG-462	69	CV125Xi	38
ASHDB IC	63	BBS096A	55	CHWG-463	69	CV125YX	38
ASHDB OC	63	BBS096AW	55	CIT-1	74	CV4512X	38
ASHDB SP	63	BBS096C	55	CKTD110	84	CV4522Xi	38
ASHDB WT	63	BBS120A	55	CP122	37	CV4527X	38
ASHDB-10	63	BBS120AW	55	CP122i	37	CV45X	38
ASHDB-2	63	BBS120C	55	CP123	37	CV45Xi	38
ASHDB-3	63	BDR115	55	CP123i	37	CV45YX	38
ASHDB-4	63	BDR115B	55	CP125	37	CV6012X	38
ASHDB-5	63	BDR115W	55	CP125i	37	CV6022Xi	38
ASHDB-6	63	BOX 3310	40	CP127	37	CV6027X	38
ASHDB-7	63	BOX3310	34	CP127i	37	CV60X	38
ASHDB-8	63	BOX3310	45	CP2202i	37	CV60Xi	38
ASHDB-8/20-1000BS	63	CB ECL	63	CP2203i	37	CV60YX	38
ASHDB-8/20-100BS	63	CB ECR	63	CP2205i	37	CV7512X	38
ASHDB-8/20-200BS	63	CB IC	63	CP2207i	37	CV7522Xi	38
ASHDB-8/20-300BS	63	CB MF	63	CP702	37	CV7527X	38
ASHDB-8/20-400BS	63	CB OC	63	CP703	37	CV75X	38
ASHDB-8/20-500BS	63	CB SP	63	CP705	37	CV75Xi	38
ASHDB-8/20-600BS	63	CB WT	63	CP707	37	CV75YX	38
ASHDB-8/20-700BS	63	CB-10	63	CP802	37	CV9012X	38
ASHDB-8/20-800BS	63	CB-1000BS	63	CP803	37	CV9022Xi	38
ASHDB-8/20-900BS	63	CB-100BS	63	CP805	37	CV9027X	38
ASHDB-9	63	CB-2	63	CP807	37	CV90X	38
B5105	15	CB-200BS	63	CS	55	CV90Xi	38
B51100	18	CB-3	63	CSB	55	CV90YX	38

Product Index Listing

Model	Page	Model	Page	Model	Page	Model	Page
CVB42X	38	DBF/DBT-300BS	61	DCS403	13	E3058T2DWB	39
CVB60X	38	DBF/DBT-400BS	61	DCS403 / 5100	17	E3058TDWB	39
CVB84X	38	DBF/DBT-500BS	61	DCS603 / 5100	17	E3210RPW	46
CVCBX	38	DBF/DBT-600BS	61	DCS803	13	E3210TRPW	46
CVSP	38	DBF/DBT-700BS	61	DC-SK-1	64	E3215RPW	46
D1600	20	DBF/DBT-800BS	61	DC-SK-1	76	E3215TRPW	46
D1600	22	DBF/DBT-900BS	61	DCS-MT303	23	E3275RPW	46
D1602	20	DBF-10/DBT-10	61	DCS-MT303	22	E3275TRPW	46
D1602	22	DBF-2/DBT-2	61	DR115	55	E3312RP	44
D1603	20	DBF-3/DBT-3	61	DR115B	55	E3312RPW	44
D1603	22	DBF-4/DBT-4	61	DR115W	55	E3312T2RP	44
D1610	20	DBF-5/DBT-5	61	DS	55	E3312T2RPW	44
D1610	22	DBF-6/DBT-6	61	DS5105	15	E3312T2SRP	45
D1612	20	DBF-7/DBT-7	61	DS51100	18	E3312T2SRPW	45
D1612	22	DBF-8/DBT-8	61	DS5120	15	E3312TRP	44
D1613	20	DBF-9/DBT-9	61	DS5150	15	E3312TRPW	44
D1613	22	DBTS ECL	62	DS5175	18	E3312TSRP	45
D2022H10BA	83	DBTS ECR	62	DSB	55	E3312TSRPW	45
D2022H10BB	83	DBTS IC	62	DSW	55	E3313RP	44
D2025H10DA	83	DBTS IECL	62	E2903-024C	54	E3313RPW	44
DBCT/DBCF ECL	61	DBTS MF	62	E2903-024HAW	52	E3313T2RP	44
DBCT/DBCF ECR	61	DBTS OC	62	E2903-024S	53	E3313T2RPW	44
DBCT/DBCF IC	61	DBTS SP	62	E2903-024SW	53	E3313T2SRP	45
DBCT/DBCF IECL	61	DBTS WT	62	E2905-028C	54	E3313T2SRPW	45
DBCT/DBCF IECR	61	DBTS-10	62	E2905-028HAW	52	E3313TRP	44
DBCT/DBCF IF	61	DBTS-1000BS	62	E2905-028S	53	E3313TRPW	44
DBCT/DBCF OC	61	DBTS-100BS	62	E2905-028SW	53	E3313TSRP	45
DBCT/DBCF SP	61	DBTS-2	62	E2906-036C	54	E3313TSRPW	45
DBCT/DBCF WT	61	DBTS-200BS	62	E2906-036HAW	52	E3321TD-RP	40
DBCT/DBCF-1000BS	61	DBTS-3	62	E2906-036S	53	E3322TD-RP	40
DBCT/DBCF-100BS	61	DBTS-300BS	62	E2906-036SW	53	E3323TD-RP	40
DBCT/DBCF-200BS	61	DBTS-4	62	E2907-040C	54	E3383D-RP	34
DBCT/DBCF-300BS	61	DBTS-400BS	62	E2907-040HAW	52	E3703-024	50
DBCT/DBCF-400BS	61	DBTS-5	62	E2907-040S	53	E3703-024B	50
DBCT/DBCF-500BS	61	DBTS-500BS	62	E2907-040SW	53	E3705-028	50
DBCT/DBCF-600BS	61	DBTS-6	62	E2910-048C	54	E3705-028B	50
DBCT/DBCF-700BS	61	DBTS-600BS	62	E2910-048HAW	52	E3706-036	50
DBCT/DBCF-800BS	61	DBTS-7	62	E2910-048S	53	E3706-036B	50
DBCT/DBCF-900BS	61	DBTS-700BS	62	E2910-048SW	53	E3707-040	50
DBCT-10/DBCF-10	61	DBTS-8	62	E2912-060C	54	E3707-040B	50
DBCT-2/DBCF-2	61	DBTS-800BS	62	E2912-060HAW	52	E3710-048	50
DBCT-3/DBCF-3	61	DBTS-9	62	E2912-060S	53	E3710-048B	50
DBCT-4/DBCF-4	61	DBTS-900BS	62	E2912-060SW	53	E3712-060	50
DBCT-5/DBCF-5	61	DC-33	25	E2915-072C	54	E3712-060B	50
DBCT-6/DBCF-6	61	DC-46	25	E2915-072HAW	52	E3715-072	50
DBCT-7/DBCF-7	61	DC-66	25	E2915-072S	53	E3715-072B	50
DBCT-8/DBCF-8	61	DC-79	25	E2915-072SW	53	E3904-28	49
DBCT-9/DBCF-9	61	DCS1003	13	E3035DWBW	34	E3904-28C	49
DBF/DBT-1000BS	61	DCS1003 / 5100	17	E3038DWBW	34	E3906-36	49
DBF/DBT-100BS	61	DCS202 / 5100	17	E3055T2DWB	39	E3906-36C	49
DBF/DBT-200BS	61	DCS303	13	E3055TDWB	39	E3910-48	49

<i>Model</i>	<i>Page</i>	<i>Model</i>	<i>Page</i>	<i>Model</i>	<i>Page</i>	<i>Model</i>	<i>Page</i>
E3910-48C	49	ET5SRTS	83	F2910-048SW	53	F3317T2SRPW	45
E3912-60	49	ET5SS	17	F2912-060C	54	F3317TRP	44
E3912-60C	49	ET5SS	83	F2912-060HAW	52	F3317TRPW	44
E3915-72	49	ET5STS	83	F2912-060S	53	F3317TSRP	45
E3915-72C	49	ET5SWS	83	F2912-060SW	53	F3317TSRPW	45
E4310RP	47	ETD5MS	83	F2915-072C	54	F3326TD-RP	40
E4310RPW	47	ETD5MTS	83	F2915-072HAW	52	F3327TD-RP	40
E4310TRP	47	ETD5SS	83	F2915-072S	53	F3386D-RP	34
E4310TRPW	47	ETD5STS	83	F2915-072SW	53	F3387D-RP	34
E4315SRP	47	F1F2605CA1	21	F2917-084C	54	F3422T	41
E4315RPW	47	F1F2607CA1	21	F2917-084S	53	F3423T	41
E4315TRP	47	F1F2610CA1	21	F2917-084SW	53	F3424T	41
E4315TRPW	47	F1F5103N	16	F2920-096C	54	F3425T	41
E4375SRP	47	F1F5103N	17	F2920-096HAW	52	F3452T	41
E4375RPW	47	F1F5105N	16	F2920-096S	53	F3453T	41
E4375TRP	47	F1F5105N	17	F2920-096SW	53	F3454T	41
E4375TRPW	47	F1F5503T	11	F2925-120C	54	F3455T	41
E4410TRP	40	F1F5505T	11	F2925-120HAW	52	F3472	36
E4415TRP	40	F1F5507T	11	F2925-120S	53	F3473	36
E4475TRP	40	F1F5510T	11	F2925-120SW	53	F3474	36
E4810RPW	48	F1F5515T	11	F2F5103N	16	F3475	36
E4810TRPW	48	F1FUH03003	13	F2F5103N	17	F3482	35
E4815RPW	48	F1FUH05003	13	F2F5105N	16	F3483	35
E4815TRPW	48	F1FUH07CA1	13	F2F5105N	17	F3484	35
E4875RPW	48	F1FUH10CA1	13	F2F5107CA1L	16	F3485	35
E4875TRPW	48	F1FUH12C03	13	F2F5107CA1L	17	F3703-024	50
E8801050	30	F1FUH15C03	13	F2F5110CA1L	16	F3703-024B	50
E8802075	30	F1FUH20CA1	13	F2F5110CA1L	17	F3705-028	50
E8803100	30	F1FUH25CA1	13	F2FUH05C03	13	F3705-028B	50
E8804125	30	F1G7203	93	F2FUH10C03	13	F3706-036	50
E8805150	30	F1G7205	93	F30522T2DWB	39	F3706-036B	50
E8806200	30	F1G7305	95	F30522TDWB	39	F3707-040	50
EPETD8D	6	F2903-024C	54	F30522TDWB	39	F3707-040B	50
EPETD8D	9	F2903-024HAW	52	F3052TDWB	39	F3710-048	50
EPETD8D	83	F2903-024S	53	F3220RPW	46	F3710-048B	50
EPETD8S	6	F2903-024SW	53	F3220T2RPW	46	F3712-060	50
EPETD8S	9	F2905-028C	54	F3316RP	44	F3712-060B	50
EPETD8S	83	F2905-028HAW	52	F3316RPW	44	F3715-072	50
EPETP8D	6	F2905-028S	53	F3316T2RP	44	F3715-072B	50
EPETP8D	9	F2905-028SW	53	F3316T2RPW	44	F3717-084	50
EPETP8D	83	F2906-036C	54	F3316T2SRP	45	F3717-084B	50
EPETP8S	6	F2906-036HAW	52	F3316T2SRPW	45	F3720-096	50
EPETP8S	9	F2906-036S	53	F3316TRP	44	F3720-096B	50
EPETP8S	83	F2906-036SW	53	F3316TRPW	44	F3725-120	50
ET5D4S	83	F2907-040C	54	F3316TSRP	45	F3725-120B	50
ET5DS	83	F2907-040HAW	52	F3316TSRPW	45	F3904-28	49
ET5DTS	83	F2907-040S	53	F3317RP	44	F3904-28C	49
ET5DWS	83	F2907-040SW	53	F3317RPW	44	F3906-36	49
ET5MS	83	F2910-048C	54	F3317T2RP	44	F3906-36C	49
ET5S4S	83	F2910-048HAW	52	F3317T2RPW	44	F3910-48	49
ET5SRS	83	F2910-048S	53	F3317T2SRP	45	F3910-48C	49

Product Index Listing

Model	Page	Model	Page	Model	Page	Model	Page
F3912-60	49	F3FUH25CA1	13	FEP-1724-3RA	9	FES-3060-3A	78
F3912-60C	49	F3FUH30CA1	13	FEP-1727-1RA	8	FES-4548-3	78
F3915-72	49	F3G7203	93	FEP-1748-1RA	8	FES-4560-3	78
F3915-72C	49	F3G7205	93	FEP-1748-3RA	9	FFH-512A	72
F3920-96	49	F3G7305	95	FEP-1812-1RA	8	FFH-912B	72
F3920-96C	49	F4320RP	47	FEP-1820-1RA	8	FH15	81
F3E7210	93	F4320RPW	47	FEP-1820-3RA	9	FHIT	81
F3E7210-2	93	F4320T2RP	47	FEP-1824-1RA	8	FHK-1	77
F3E7215	93	F4320T2RPW	47	FEP-1824-3RA	9	FHK-1324-3A	76
F3E7215-2	93	F4320TRP	47	FEP-1827-1RA	8	FHK-1348-3A	76
F3E7220-2	93	F4320TRPW	47	FEP-1848-1RA	8	FHK-212-1CA	76
F3E7223-2	93	F4420T2RP	40	FEP-1848-3RA	9	FHK-224-1A	76
F3E7310	95	F4420TRP	40	FEP-3420-1RA	8	FHK-248-1A	76
F3E7310-2	95	F4820RPW	48	FEP-3420-3RA	9	FHK-424-1A	76
F3E7312	95	F4820T2RPW	48	FEP-3424-1RA	8	FHK-448-1A	76
F3E7312-2	95	F4820TRPW	48	FEP-3424-3RA	9	FHK-624-3A	76
F3E7315	95	F8801050	30	FEP-3427-1RA	8	FHK-648-3A	76
F3E7315-2	95	F8802075	30	FEP-3448-1RA	8	FPC2110	75
F3F2605CA1	21	F8803100	30	FEP-3448-3RA	9	FPC2120	75
F3F2607CA1	21	F8804125	30	FEP-3457-1RA	8	FPC2140	75
F3F2610CA1	21	F8805150	30	FEP-3620-1RA	8	FPC2160	75
F3F2615CA1	21	F8806200	30	FEP-3620-3RA	9	FPC2210	75
F3F2625CA1	21	FAM33	25	FEP-3624-1RA	8	FPC2220	75
F3F2630CA1	21	FAM46	25	FEP-3624-3RA	9	FPC2240	75
F3F2640CA1	21	FAM66	25	FEP-3627-1RA	8	FPC2260	75
F3F2650CA1	21	FAM79	25	FEP-3648-1RA	8	FPC4110	75
F3F5115CA1L	16	FEC-30-120	74	FEP-3648-3RA	9	FPC4120	75
F3F5115CA1L	17	FEC-30-240	74	FEP-3657-1RA	8	FPC4140	75
F3F5125CA1L	16	FEC-60-120	74	FEP-3820-1RA	8	FPC4160	75
F3F5125CA1L	17	FEC-60-240	74	FEP-3820-3RA	9	FPC4210	75
F3F5130CA1L	16	FEP-0812-1RA	8	FEP-3824-1RA	8	FPC4220	75
F3F5130CA1L	17	FEP-0820-1RA	8	FEP-3824-3RA	9	FPC4240	75
F3F5140CA1L	16	FEP-0820-3RA	9	FEP-38271-RA	8	FPC4260	75
F3F5140CA1L	17	FEP-0824-1RA	8	FEP-3848-1RA	8	FPC7110	75
F3F5150CA1L	16	FEP-0824-3RA	9	FEP3848-3RA	9	FPC7120	75
F3F5150CA1L	17	FEP-0827-1RA	8	FEP-7620-1RA	8	FPC7140	75
F3F5160CA1	19	FEP-0848-1RA	8	FEP-7620-3RA	9	FPC7160	75
F3F5170CA1	19	FEP-0848-3RA	9	FEP-7624-1RA	8	FPC7210	75
F3F5503T	11	FEP-1612-1RA	8	FEP-7624-3RA	9	FPC7220	75
F3F5505T	11	FEP-1620-1RA	8	FEP-7627-1RA	8	FPC7240	75
F3F5507T	11	FEP-1620-3RA	9	FEP-7648-1RA	8	FPC7260	75
F3F5510T	11	FEP-1624-1RA	8	FEP-7648-3RA	9	FPC8110	75
F3F5515T	11	FEP-1624-3RA	9	FEP-7657-1RA	8	FPC8120	75
F3F5520T	11	FEP-1627-1RA	8	FES-0924-1C	78	FPC8140	75
F3F5525T	11	FEP-1648-1RA	8	FES-1024-1CA	78	FPC8160	75
F3F5530T	11	FEP-1648-3RA	9	FES-1520-3A	78	FPC8210	75
F3FUH03C03	13	FEP-1657-1RA	8	FES-1524-1A	78	FPC8220	75
F3FUH07C03	13	FEP-1712-1RA	8	FES-1524-3E	78	FPC8240	75
F3FUH12C03	13	FEP-1720-1RA	8	FES-1548-3E	78	FPC8260	75
F3FUH15C03	13	FEP-1720-3RA	9	FES-1560-3A	78	FS5101	17
F3FUH20CA1	13	FEP-1724-1RA	8	FES-3048-3A	78	FS5101	19

Model	Page	Model	Page	Model	Page	Model	Page
FS5102	17	G2910-048C	54	G3315TRP	44	G3709-060B	50
FS5102	19	G2910-048HAW	52	G3315TRPW	44	G3710-048	50
FSW5111	17	G2910-048S	53	G3316RP	44	G3710-048B	50
FSW5112	17	G2910-048SW	53	G3316RPW	44	G3711-072	50
FSW5112	22	G2911-072C	54	G3316T2RP	44	G3711-072B	50
G1G2605CA1	21	G2911-072HAW	52	G3316T2RPW	44	G3712-060	50
G1G2607CA1	21	G2911-072S	53	G3316TRP	44	G3712-060B	50
G1G2610CA1	21	G2911-072SW	53	G3316TRPW	44	G3713-084	50
G1G5103N	16	G2912-060C	54	G3317RP	44	G3713-084B	50
G1G5103N	17	G2912-060HAW	52	G3317RPW	44	G3715-072	50
G1G5105N	16	G2912-060S	53	G3317T2RP	44	G3715-072B	50
G1G5105N	17	G2912-060SW	53	G3317T2RPW	44	G3715-096	50
G1G5107CA1L	16	G2913-084C	54	G3317TRP	44	G3715-096B	50
G1G5107CA1L	17	G2913-084S	53	G3317TRPW	44	G3717-084	50
G1G5110CA1N	16	G2913-084SW	53	G3323TD-RP	40	G3717-084B	50
G1G5110CA1N	17	G2915-072C	54	G3324TD-RP	40	G3718-120	50
G1G5503T	11	G2915-072HAW	52	G3325TD-RP	40	G3718-120B	50
G1G5505T	11	G2915-072S	53	G3326TD-RP	40	G3720-096	50
G1G5507T	11	G2915-072SW	53	G3327TD-RP	40	G3720-096B	50
G1G5510T	11	G2915-096C	54	G3383D-RP	34	G3725-120	50
G1G7203	93	G2915-096HAW	52	G3384D-RP	34	G3725-120B	50
G1G7205	93	G2915-096S	53	G3385D-RP	34	G3904-28	49
G1G7305	95	G2915-096SW	53	G3386D-RP	34	G3904-28C	49
G1GUH03003	13	G2917-084C	54	G3387D-RP	34	G3906-36	49
G1GUH05003	13	G2917-084S	53	G3422T	41	G3906-36C	49
G1GUH07CA1	13	G2917-084SW	53	G3423T	41	G3910-48	49
G1GUH10CA1	13	G2918-120C	54	G3424T	41	G3910-48C	49
G2903-024C	54	G2918-120HAW	52	G3425T	41	G3912-60	49
G2903-024HAW	52	G2918-120S	53	G3452T	41	G3912-60C	49
G2903-024S	53	G2918-120SW	53	G3453T	41	G3915-72	49
G2903-024SW	53	G2920-096C	54	G3454T	41	G3915-72C	49
G2905-028C	54	G2920-096HAW	52	G3455T	41	G3920-96	49
G2905-028HAW	52	G2920-096S	53	G3472	36	G3920-96C	49
G2905-028S	53	G2920-096SW	53	G3473	36	G8801050	30
G2905-028SW	53	G2925-120C	54	G3474	36	G8802075	30
G2906-036C	54	G2925-120HAW	52	G3475	36	G8803100	30
G2906-036HAW	52	G2925-120S	53	G3482	35	G8804125	30
G2906-036S	53	G2925-120SW	53	G3483	35	G8805150	30
G2906-036SW	53	G3032DWBW	34	G3484	35	G8806200	30
G2907-040C	54	G3052T2DWB	39	G3485	35	GF-SK-1	64
G2907-040HAW	52	G3052TDWB	39	G3703-024	50	GF-SK-1	76
G2907-040S	53	G3314RP	44	G3703-024B	50	H1D1AA	85
G2907-040SW	53	G3314RPW	44	G3705-028	50	H1G7203	93
G2907-048C	54	G3314T2RP	44	G3705-028B	50	H1G7205	93
G2907-048HAW	52	G3314T2RPW	44	G3706-036	50	H1G7305	95
G2907-048S	53	G3314TRP	44	G3706-036B	50	H1H2605CA1	21
G2907-048SW	53	G3314TRPW	44	G3707-040	50	H1H2607CA1	21
G2909-060C	54	G3315RP	44	G3707-040B	50	H1H2610CA1	21
G2909-060HAW	52	G3315RPW	44	G3707-048	50	H1H5503T	11
G2909-060S	53	G3315T2RP	44	G3707-048B	50	H1H5505T	11
G2909-060SW	53	G3315T2RPW	44	G3709-060	50	H1H5507T	11

Product Index Listing

Model	Page	Model	Page	Model	Page	Model	Page
H1H5510T	11	H2915-072SW	53	H3482	35	H3G7315-2	95
H1H5515T	11	H2915-72AWi	52	H3483	35	H3H2605CA1	21
H1HUH03003	13	H2917-084C	54	H3484	35	H3H2607CA1	21
H1HUH05003	13	H2917-084CI	54	H3485	35	H3H2610CA1	21
H1HUH07CA1	13	H2917-084S	53	H3703-024	50	H3H2615CA1	21
H1HUH10CA1	13	H2917-084SW	53	H3703-024B	50	H3H2620CA1	21
H1HUH12C03	13	H2917-84AWi	52	H3705-028	50	H3H2625CA1	21
H1HUH15C03	13	H2920-096C	54	H3705-028B	50	H3H2630CA1	21
H1HUH20CA1	13	H2920-096CI	54	H3706-036	50	H3H2640CA1	21
H1HUH25CA1	13	H2920-096HAW	52	H3706-036B	50	H3H2650CA1	21
H1HUH30CA1	13	H2920-096S	53	H3707-040	50	H3H5503T	11
H2903-024C	54	H2920-096SW	53	H3707-040B	50	H3H5505T	11
H2903-024CI	54	H2920-120AWi	52	H3710-048	50	H3H5507T	11
H2903-024HAW	52	H2925-120C	54	H3710-048B	50	H3H5510T	11
H2903-024S	53	H2925-120CI	54	H3712-060	50	H3H5515T	11
H2903-024SW	53	H2925-120HAW	52	H3712-060B	50	H3H5520T	11
H2903-24AWi	52	H2925-120S	53	H3715-072	50	H3H5525T	11
H2905-028C	54	H2925-120SW	53	H3715-072B	50	H3H5530T	11
H2905-028CI	54	H2HUH05C03	13	H3717-084	50	H3H5605T	23
H2905-028HAW	52	H2HUH07C03	13	H3717-084B	50	H3H5705T	22
H2905-028S	53	H3032DWBW	34	H3720-096	50	H3HUH03C03	13
H2905-028SW	53	H30522T2DWB	39	H3720-096B	50	H3HUH12C03	13
H2905-28AWi	52	H30522TDWB	39	H3725-120	50	H3HUH15C03	13
H2906-036C	54	H3052T2DWB	39	H3725-120B	50	H3HUH20CA1	13
H2906-036C	54	H3052TDWB	39	H3904-28	49	H3HUH25CA1	13
H2906-036HAW	52	H3275RPW	46	H3904-28C	49	H3HUH30CA1	13
H2906-036S	53	H3275T2RPW	46	H3906-36	49	H46D1214	85
H2906-036SW	53	H3317RP	44	H3906-36C	49	H474 TMC	80
H2906-36AWi	52	H3317RPW	44	H3910-48	49	H5520/HMK	10
H2907-040C	54	H3317T2RP	44	H3910-48C	49	H5550/HMK	10
H2907-040C	54	H3317T2RPW	44	H3912-60	49	H8801050	30
H2907-040HAW	52	H3317T2SRP	45	H3912-60C	49	H8801050i	30
H2907-040S	53	H3317T2SRPW	45	H3915-72	49	H8802075	30
H2907-040SW	53	H3317TRP	44	H3915-72C	49	H8802075i	30
H2907-40AWi	52	H3317TRPW	44	H3920-96	49	H8803100	30
H2910-048C	54	H3317TSRP	45	H3920-96C	49	H8803100i	30
H2910-048CI	54	H3317TSRPW	45	H3G7203	93	H8804125	30
H2910-048HAW	52	H3327TD-RP	40	H3G7205	93	H8804125i	30
H2910-048S	53	H3387D-RP	34	H3G7210	93	H8805150	30
H2910-048SW	53	H3422T	41	H3G7210-2	93	H8805150i	30
H2910-48AWi	52	H3423T	41	H3G7215	93	H8806200	30
H2912-060C	54	H3424T	41	H3G7215-2	93	H8806200i	30
H2912-060C	54	H3425T	41	H3G7220-2	93	HF1B5103N	16
H2912-060HAW	52	H3452T	41	H3G7223-2	93	HF1B5103N	17
H2912-060S	53	H3453T	41	H3G7230-2	93	HF1B5105N	16
H2912-060SW	53	H3454T	41	H3G7305	95	HF1B5105N	17
H2912-60AWi	52	H3455T	41	H3G7310	95	HF2B5103N	16
H2915-072C	54	H3472	36	H3G7310-2	95	HF2B5103N	17
H2915-072CI	54	H3473	36	H3G7312	95	HF2B5105N	16
H2915-072HAW	52	H3474	36	H3G7312-2	95	HF2B5105N	17
H2915-072S	53	H3475	36	H3G7315	95	HF2B5107CA1L	16

Model	Page	Model	Page	Model	Page	Model	Page
HF2B5107CA1L	17	HF3B5150CA1L	17	HLA 12-208360-3.0-24	5	HP8-1440120-2T	91
HF2B5110CA1L	16	HF3B5160CA1	19	HLA 12-208360-5.0-24	5	HP8-1440120-2T	91
HF2B5110CA1L	17	HF3B5170CA1	19	HLA 12-208360-7.5-24	5	HP8-1440120-2TRP	92
HF2BUH10C03	13	HF3B5180CA1	19	HLA 12-240160-3.0-24	5	HP8C-12PK	91
HF3210RPW	46	HF3B5190CA1	19	HLA 12-240160-5.0-24	5	HP8H-12PK	91
HF3210T2RPW	46	HF4310RP	47	HLA 12-240160-7.5-24	5	ICH-240C	80
HF3215RPW	46	HF4310RPW	47	HLA 12-240360-3.0-24	5	J3422T	41
HF3215T2RPW	46	HF4310T2RP	47	HLA 12-240360-5.0-24	5	J3423T	41
HF3220RPW	46	HF4310T2RPW	47	HLA 12-240360-7.5-24	5	J3424T	41
HF3220T2RPW	46	HF4310TRP	47	HLA 12-480360-3.0-24	5	J3425T	41
HF3222RPW	46	HF4310TRPW	47	HLA 12-480360-5.0-24	5	J3452T	41
HF3222T2RPW	46	HF4315RP	47	HLA 12-480360-7.5-24	5	J3453T	41
HF3315SRP	44	HF4315RPW	47	HLA 16-208360-10.0-24	5	J3454T	41
HF3315RPW	44	HF4315T2RP	47	HLA 16-240160-10.0-24	5	J3455T	41
HF3315T2RP	44	HF4315T2RPW	47	HLA 16-240360-10.0-24	5	J3472	36
HF3315T2RPW	44	HF4315TRP	47	HLA 16-480360-10.0-24	5	J3473	36
HF3315T2SRP	45	HF4315TRPW	47	HLA 20-208360-15.0-24	5	J3474	36
HF3315T2SRPW	45	HF4320RP	47	HLA 20-240360-15.0-24	5	J3475	36
HF3315TRP	44	HF4320RPW	47	HLA 20-480360-15.0-24	5	J3482	35
HF3315TRPW	44	HF4320T2RP	47	HLA 20-480360-20.0-24	5	J3483	35
HF3315TSRP	45	HF4320T2RPW	47	HLA 20-480360-25.0-24	5	J3484	35
HF3315TSRPW	45	HF4320TRP	47	HLA 20-600360-15.0-24	5	J3485	35
HF3316RP	44	HF4320TRPW	47	HLA 20-600360-20.0-24	5	JK	55
HF3316RPW	44	HF4375RP	47	HLA 20-600360-25.0-24	5	JKB	55
HF3316T2RP	44	HF4375RPW	47	HLHM	6	JKW	55
HF3316T2RPW	44	HF4375T2RP	47	HLP M10	6	K3422T	41
HF3316T2SRP	45	HF4375T2RPW	47	HLP M1525	6	K3423T	41
HF3316T2SRPW	45	HF4375TRP	47	HLP M37	6	K3424T	41
HF3316TRP	44	HF4375TRPW	47	HLT-1	6	K3425T	41
HF3316TRPW	44	HF4410T2RP	40	HLT-1	9	K3452T	41
HF3316TSRP	45	HF4415T2RP	40	HLT-1	83	K3453T	41
HF3316TSRPW	45	HF4420T2RP	40	HLT-2	6	K3454T	41
HF3323TD-RP	40	HF4475T2RP	40	HLT-2	9	K3455T	41
HF3324TD-RP	40	HF4810RPW	48	HLT-2	83	K3472	36
HF3325TD-RP	40	HF4810T2RPW	48	HLWM10	6	K3473	36
HF3326TD-RP	40	HF4815RPW	48	HLWM1525	6	K3474	36
HF3384D-RP	34	HF4815T2RPW	48	HLWM37	6	K3475	36
HF3385D-RP	34	HF4820RPW	48	HP-11-QT	77	K3482	35
HF3386D-RP	34	HF4820T2RPW	48	HP-5-QT	77	K3483	35
HF3B51100CA1	19	HF4875RPW	48	HP6-1000120-2CT	91	K3484	35
HF3B5115CA1L	16	HF4875T2RPW	48	HP6-1000120-2CT	91	K3485	35
HF3B5115CA1L	17	HF5605T	23	HP6-1000120-2CTRP	92	KB33	25
HF3B5120CA1L	16	HF5705T	22	HP6-1000120-2T	91	KB46	25
HF3B5120CA1L	17	HF5840TC	80	HP6-1000120-2T	91	KB66	25
HF3B5125CA1L	16	HF5848TC	80	HP6-1000120-2TRP	92	KB79	25
HF3B5125CA1L	17	HF684TC	80	HP6C-12PK	91	KT110	84
HF3B5130CA1L	16	HF685TC	80	HP6H-12PK	91	KT121	84
HF3B5130CA1L	17	HF686TC	80	HP-6-QT	77	KTD110	84
HF3B5140CA1L	16	HLA 12-208160-3.0-24	5	HP8-1440120-2CT	91	KTO110	84
HF3B5140CA1L	17	HLA 12-208160-5.0-24	5	HP8-1440120-2CT	91	KTO121	84
HF3B5150CA1L	16	HLA 12-208160-7.5-24	5	HP8-1440120-2CTRP	92	L06Y-01	84

Product Index Listing

Model	Page	Model	Page	Model	Page	Model	Page
L08Y-01	84	MFHE-0300-6-FAAF2D	92	MS4123	33	P3483A1	35
L8801050	30	MFHE-0300-6-HAA	92	MS4124	33	P3484A1	35
L8802075	30	MFHE-0300-6-HAAF2D	92	MS4125	33	P3485A1	35
L8803100	30	MFHE-0300-6-HAARP	92	MS4126	33	P3G7203	93
L8804125	30	MFHE-0300-8-EAA	92	MS4142	33	P3G7205	93
L8805150	30	MFHE-0300-8-EAAC	92	MS4143	33	P3G7210	93
L8806200	30	MFHE-0300-8-EAACRP	92	MS4144	33	P3G7210-2	93
LVRS	55	MFHE-0300-8-EAARP	92	MS4145	33	P3G7215	93
LVR SB	55	MFHE-0300-8-HAA	92	MS4146	33	P3G7215-2	93
LVR SW	55	MFHE-0300-8-HAARP	92	MSE4140-12	33	P3G7220-2	93
M2903-024CI	54	MM-13A	72	N3472T2i	36	P3G7225-2	93
M2903-24AWi	52	MM-18A	72	N3473T2i	36	P3G7230-2	93
M2905-028CI	54	MM-24A	72	N3474T2i	36	P3G7235-2	93
M2905-28AWi	52	MM-33A	72	N3482T2i	35	P3G7240-2	93
M2906-036CI	54	MM-46A	72	N3483T2i	35	P3G7245-2	93
M2906-36AWi	52	MMWG-13	72	N3484T2i	35	P3G7250-2	93
M2907-040CI	54	MMWG-18	72	OCH-46-120VCE	70	P3G7305	95
M2907-40AWi	52	MMWG-24	72	OCH-46-120VE	70	P3G7310	95
M2910-048CI	54	MMWG-33	72	OCH-46-120V-SSE	70	P3G7310-2	95
M2910-48AWi	52	MMWG-46	72	OCH-46-208VE	70	P3G7312	95
M2912-060CI	54	MR-13	65	OCH-46-208V-SSE	70	P3G7312-2	95
M2912-60AWi	52	MR-1320-3	64	OCH-46-240VE	70	P3G7315	95
M2915-072CI	54	MR-1324-3	64	OCH-46-240V-SSE	70	P3G7315-2	95
M2915-72AWi	52	MR-1327-3	64	OCH-46-277VE	70	P3G7318	95
M2917-084CI	54	MR-1348-3	64	OCH-46-277V-SSE	70	P3G7318-2	95
M2917-84AWi	52	MR-1357-3	64	OCH-57-208VCE	70	P3P2605CA1	21
M2920-096CI	54	MR-2	65	OCH-57-208VE	70	P3P2607CA1	21
M2925-120AWi	52	MR-212-1	64	OCH-57-208V-SSE	70	P3P2610CA1	21
M2925-120CI	54	MR-220-1	64	OCH-57-240VCE	70	P3P2615CA1	21
M3324TD-RPi	40	MR-224-1	64	OCH-57-240VE	70	P3P2620CA1	21
M3325TD-RPi	40	MR-227-1	64	OCH-57-240V-SSE	70	P3P2625CA1	21
M3384D-RPi	34	MR-248-1	64	OCH-57-277VE	70	P3P2630CA1	21
M3385D-RPi	34	MR-257-1	64	OCH-57-277V-SSE	70	P3P2640CA1	21
M3386D-RPi	34	MR-27	65	OCH-57-480VE	70	P3P2650CA1	21
M3472T2i	36	MR-2720-3	64	OCH-57-480V-SSE	70	P3P5103CA1N	16
M3473T2i	36	MR-2724-3	64	OCH-EBK-120	70	P3P5103CA1N	17
M3474T2i	36	MR-2748-3	64	OCH-EBK-208	70	P3P5105CA1N	16
M3482T2i	35	MR-2757-3	64	OCH-EBK-240	70	P3P5105CA1N	17
M3483T2i	35	MR-4	65	OCH-EBK-480	70	P3P5107CA1L	17
M3484T2i	35	MR-420-1	64	OCHWG-46	70	P3P5107CA1N	16
M8801050i	30	MR-424-1	64	OCHWG-57	70	P3P51100CA1	19
M8802075i	30	MR-427-1	64	OFG 51100	18	P3P5110CA1N	16
M8803100i	30	MR-448-1	64	OFG 5175	18	P3P5110CA1N	17
M8804125i	30	MR-457-1	64	OFG5101	15	P3P5115CA1L	17
M8805150i	30	MR-6	65	OFG5102	15	P3P5115CA1N	16
M8806200i	30	MR-620-3	64	OFG5103	15	P3P5120CA1N	16
MCS120-8CT	91	MR-624-3	64	P3472A1	36	P3P5120CA1N	17
MFHE-0300-6-EAA	92	MR-627-3	64	P3473A1	36	P3P5125CA1N	16
MFHE-0300-6-EAAC	92	MR-648-3	64	P3474A1	36	P3P5125CA1N	17
MFHE-0300-6-EAACRP	92	MR-657-3	64	P3475A1	36	P3P5130CA1N	16
MFHE-0300-6-EAARP	92	MS4122	33	P3482A1	35	P3P5130CA1N	17

Model	Page	Model	Page	Model	Page	Model	Page
P3P5140CA1N	16	PD35-1624-3	97	R3H5115CA1	16	RDBT-PDIECR	63
P3P5140CA1N	17	PD40-1624-3	97	R3H5120CA1	16	RDBT-PDOC	63
P3P5150CA1N	16	PD45-1630-3	97	R3H5125CA1	16	RFKit-5	85
P3P5150CA1N	17	PD50-1630-3	97	R3H5130CA1	16	RFKIT-5	92
P3P5160CA1	19	PD5-812-1	97	R3H5140CA1	16	RFR-5	85
P3P5170CA1	19	PD-812-3	97	RCP122	37	RFT-1	85
P3P5180CA1	19	PHLA12-208160-3.0-24-TDP	7	RCP122i	37	RHG-1012A	77
P3P5190CA1	19	PHLA12-208160-5.0-24-TDP	7	RCP123	37	RHG-1012B	77
P3P5503T	11	PHLA12-208160-7.5-24-TDP	7	RCP123i	37	RK120EAA	87
P3P5505T	11	PHLA12-208360-3.0-24-TDP	7	RCP125	37	RK124EAA	87
P3P5507T	11	PHLA12-208360-5.0-24-TDP	7	RCP125i	37	RK130EAA	87
P3P5510T	11	PHLA12-208360-7.5-24-TDP	7	RCP127	37	RK134EAA	87
P3P5515T	11	PHLA12-240160-3.0-24-TDP	7	RCP127i	37	RKWP1AA	87
P3P5520T	11	PHLA12-240160-5.0-24-TDP	7	RCP2202i	37	RMF-222-A	69
P3P5525T	11	PHLA12-240160-7.5-24-TDP	7	RCP2203i	37	RMF-222-SS-A	69
P3P5530T	11	PHLA12-240360-3.0-24-TDP	7	RCP2205i	37	RMF-223	69
P3P5540T	11	PHLA12-240360-5.0-24-TDP	7	RCP2207i	37	RMF-223-SS	69
P3P5548T	11	PHLA12-240360-7.5-24-TDP	7	RCP702	37	RMF-342-A	69
P3P5605T	23	PHLA12-480360-3.0-24-TDP	7	RCP703	37	RMF-342-SS-A	69
P3P5705T	22	PHLA12-480360-5.0-24-TDP	7	RCP705	37	RMF-343	69
P3PUH03CA1	13	PHLA12-480360-7.5-24-TDP	7	RCP707	37	RMF-343-SS	69
P3PUH05CA1	13	PHLA12-600360-3.0-24-TDP	7	RCP802	37	RMF-462-A	69
P3PUH07CA1	13	PHLA12-600360-5.0-24-TDP	7	RCP803	37	RMF-462-SS-A	69
P3PUH10CA1	13	PHLA12-600360-7.5-24-TDP	7	RCP805	37	RMF-463	69
P3PUH12CA1	13	PHLA16-208360-10.0-24-TDP	7	RCP807	37	RMF-463-SS	69
P3PUH15CA1	13	PHLA16-240160-10.0-24-TDP	7	RD5120	15	RPH1-5A	81
P3PUH20CA1	13	PHLA16-240360-10.0-24-TDP	7	RD5120	15	RPH-208-A	72
P3PUH25CA1	13	PHLA16-480360-10.0-24-TDP	7	RD5150	15	RPH22-5Ai	81
P3PUH30CA1	13	PHLA16-600360-10.0-24-TDP	7	RD5150	15	RPH22-5ASi	81
P3PUH40CA1	13	PHLA20-208360-15.0-24-TDP	7	RD5175	15	RPH-240-A	72
P3PUH48CA1	13	PHLA20-240360-15.0-24-TDP	7	RDBT-PD-10	63	RPH2-5A	81
P5520/PMK	10	PHLA20-480360-15.0-24-TDP	7	RDBT-PD-1000BS	63	RPH2-5Ai	81
P5550/PMK	10	PHLA20-480360-20.0-24-TDP	7	RDBT-PD-100BS	63	RPH2-5ASi	81
P8801050	30	PHLA20-480360-25.0-24-TDP	7	RDBT-PD-2	63	RPHWG	72
P8802075	30	PHLA20-600360-15.0-24-TDP	7	RDBT-PD-200BS	63	S2022H10AA	83
P8803100	30	PHLA20-600360-20.0-24-TDP	7	RDBT-PD-3	63	S2022H10AB	83
P8804125	30	PHLA20-600360-25.0-24-TDP	7	RDBT-PD-300BS	63	S2025H10AA	17
P8805150	30	PT3480	35	RDBT-PD-4	63	S2025H10AA	83
P8806200	30	Q3H5103CA1	16	RDBT-PD-400BS	63	SB-6*	92
PCH-48C	77	Q3H5105CA1	16	RDBT-PD-5	63	SB6-120-CT	91
PD10-1018-1	97	Q3H5107CA1	16	RDBT-PD-500BS	63	SB6-120-T	91
PD10-1018-3	97	Q3H5110CA1	16	RDBT-PD-6	63	SB-8*	92
PD15-1218-1	97	Q3H5115CA1	16	RDBT-PD-600BS	63	SB8-120-CT	91
PD15-1218-1-3	97	Q3H5120CA1	16	RDBT-PD-7	63	SB8-120-T	91
PD15-1218-2-3	97	Q3H5125CA1	16	RDBT-PD-700BS	63	SDHW1001	82
PD20-1220-1	97	Q3H5130CA1	16	RDBT-PD-8	63	SF200	37
PD20-1220-3	97	Q3H5140CA1	16	RDBT-PD-800BS	63	SF400	37
PD25-1620-1	97	R3H5103CA1	16	RDBT-PD-9	63	SO 4/4	78
PD25-1620-3	97	R3H5105CA1	16	RDBT-PD-900BS	63	SO 6/4	78
PD30-1624-2-3	97	R3H5107CA1	16	RDBT-PDIC	63	SR120	55
PD30-1624-3-3	97	R3H5110CA1	16	RDBT-PDIECL	63	SR120B	55

Product Index Listing

Model	Page	Model	Page	Model	Page
SR120W	55	TUH1	13	WWA05	55
SR220	55	TW123	17	WWA06	55
SR220B	55	TW123 / TH5220D	86	WWA07	55
SR220W	55	TW145	84	WWA08	55
T4398A1021	85	TW146	84	WWA09	55
T5100	17	TW1512	17	Y3472A1	36
T5100	17	TW155A	11	Y3473A1	36
T5102	17	TW155A	84	Y3474A1	36
T5122	17	TW255A	11	Y3475A1	36
TAT20-480-3/3BB/1T	89	TW255A	84	Y3482A1	35
TAT24-FAN-120V-1	89	U3H2605CA4	21	Y3483A1	35
TAT-30	89	U3H2607CA4	21	Y3484A1	35
TAT-45	89	U3H2610CA4	21	Y3485A1	35
TAT5-208-1/3BB/1T	89	U3H2615CA4	21	YES-1520-3A	78
TAT5-240-1/3BB/1T	89	U3H2620CA4	21	YES-1524-1A	78
TAT8-208-1/3BB/1T	89	U3U2625CA1	21	YES-1524-3E	78
TAT8-240-1/3BB/1T	89	U3U2630CA1	21	YES-1548-3E	78
TAT-ILC-25	89	U3U2640CA1	21	YES-3048-3A	78
TB3000	34	U3U2650CA1	21		
TB3380	34	U8801050	30		
TBD	55	U8802075	30		
TBD-TP	55	U8803100	30		
TBS	55	U8804125	30		
TBS-TP	55	U8805150	30		
TC1602	17	U8806200	30		
TC1602	22	UHB-1	13		
TC5102	17	UHB-3	13		
TC5103	17	UHB-4	13		
TF-33	25	UT1001	87		
TF-46	25	UT3001	87		
TF-66	25	UT5001	87		
TF-79	25	UT6001	87		
TFS5101	17	UT8001	87		
TFS5102	17	UT9001	87		
TG1	87	V5105	15		
TG1B	87	V51100	18		
TG2	87	V5120	15		
TG2B	87	V5150	15		
TG3	87	VHC-15	70		
TG3B	87	VHC-15	74		
TG4	87	VHC-32	70		
TG5	87	VHC-32	74		
TG6	87	VMB-41-SS	69		
TH115-A-024T	86	VMB-41-SS	70		
TH148LE-P	86	W5520/WMK	10		
TL8230A1003	85	W5550/WMK	10		
TO-SK-1	76	WWA00	55		
TSH1TX	81	WWA01	55		
TSH20J	81	WWA02	55		
TSH20JW	81	WWA03	55		
TSH2TX	81	WWA04	55		