



# 18 INCHES, OSCILLATING STAND FAN

OWNER'S MANUAL  
Model # FSM-45



**PLEASE READ AND SAVE THESE INSTRUCTIONS**

## 18 IN. OSCILLATING STAND FAN

Thank you for choosing a Soleus Air fan. This owner's manual will provide you with valuable information necessary for the proper care and maintenance of your new product. Please take a few moments to thoroughly read the instructions and familiarize yourself with all the operational aspects of your new fan.

For your own records, please attach a copy of your sales receipt to this manual. Also, write the store name/location and date purchased below:

Store Name: \_\_\_\_\_

Location: \_\_\_\_\_

Date Purchased: \_\_\_\_\_

### **WARNINGS**

When using this electric unit, basic safety precautions should always be followed to reduce the risk of fire, electric shock and personal injury, including the following:

- 1) Read all instructions before using this unit.
- 2) Use only for intended household use as described in this manual.
- 3) Plug the fan directly into a 120 V A/C electrical outlet.
- 4) Never insert your fingers, pencils, or other objects through the fan grill during operation.
- 5) The fan should be used on a stable and level surface. Do not operate without the grill being properly in place.
- 6) Do not expose the fan to excessive heat or humidity. This could cause damage to the electrical components.
- 7) Do not immerse in any type of liquid. Do not use near water.
- 8) The fan should be kept out of the reach of children. Close supervision is necessary when the fan is used by or near children.
- 9) Do not operate this or any appliance with a damaged cord, if the unit malfunctions, or if it has been dropped or damaged in any manner. Connect to properly polarized outlets only.
- 10) Do not cover the cord or place near heat sources. Keep the cord away from high traffic areas, and do not submerge in water.

- 11) Unplug the fan before moving, cleaning or making repairs. NOTE: If for any reason this unit requires service, return appliance to manufacturer or a similarly qualified service agent to ensure safety.
- 12) To reduce the risk of fire or electric shock, do not use this fan with any solid-state speed control device.
- 13) To disconnect, grip plug and pull from wall outlet. Never pull on the cord to unplug.
- 14) For indoor use only.

<p>(A) Grounding Pin</p> <p>Three-slot Grounded Outlet</p> <p>(B) Grounding Pin</p> <p>ADAPTER</p> <p>Grounding Tab</p> <p>Mounting Screw</p> <p>Two-slot Grounded Outlet</p>	<p><b>WARNING</b></p> <p>This fan has a grounded three pronged plug intended to fit into a three slot outlet. (A) An adapter is available for connecting three pronged plugs into two slot outlets. (B) When doing so, the green grounding tab extending from the adapter must be fastened under the wall plate's mounting screw. The adapter should not be used if a three-slot outlet is available.</p> <p><b>DO NOT DEFEAT THE SAFETY PURPOSE OF THE GROUNDED PLUG.</b></p>
---	--

## TECHNICAL SPECIFICATIONS

Voltage Rating	120V, 60Hz
Power Consumption	60W
Unit Size	20 in. (W) x 16 in. (D) x 47 in. (H)
Unit Weight	16.5 lbs

This product employs overload protection (fuse). A blown fuse indicates an overload or short-circuit situation. If the fuse blows, unplug the product from the outlet. Replace the fuse per the instructions below and check the product. If the replacement fuse blows, a short-circuit may be present and the product should be discarded or returned to an authorized service facility for examination and/or repair.

## HOW TO REPLACE THE FUSE

1. Unplug the fan from the outlet. Place the plug on a firm, flat surface. Open the fuse cover, located on the top of the plug, using your thumb or a flathead screwdriver to slide the cover towards the prongs.

NOTE: Ensure that the fuse cover is completely open before attempting to remove the fuse.

2. Remove the fuse carefully by using a small screwdriver to pry the fuse out of the compartment by the metal ends of the fuse.
3. Risk of fire. Insert a new 5 Amp, 125 Volt fuse into the fuse compartment, making sure that the fuse is securely in place.
4. Slide the fuse cover closed completely. If the fuse cover is difficult to close, make sure the fuse is properly secured in place by pressing down on the metal ends of the fuse.

**CAUTION:** Risk of fire. Do not replace the attachment plug. It contains a safety device (fuse) that should not be removed. Do not use the product if the attachment plug is damaged.

To avoid a risk of fire, only replace with a 5 Amp, 125 Volt fuse.

To order a new fuse, contact Soleus Air at: (888) 876-5387

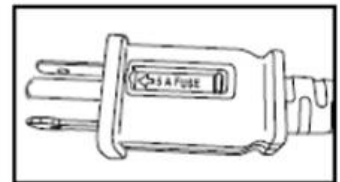
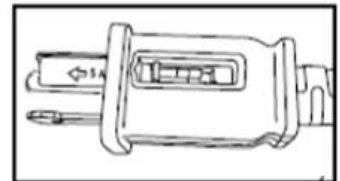
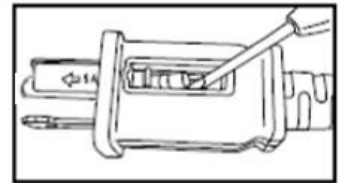
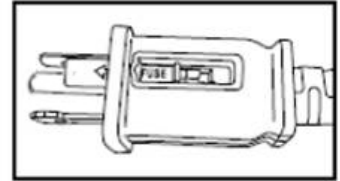

# PRODUCT DIAGRAM

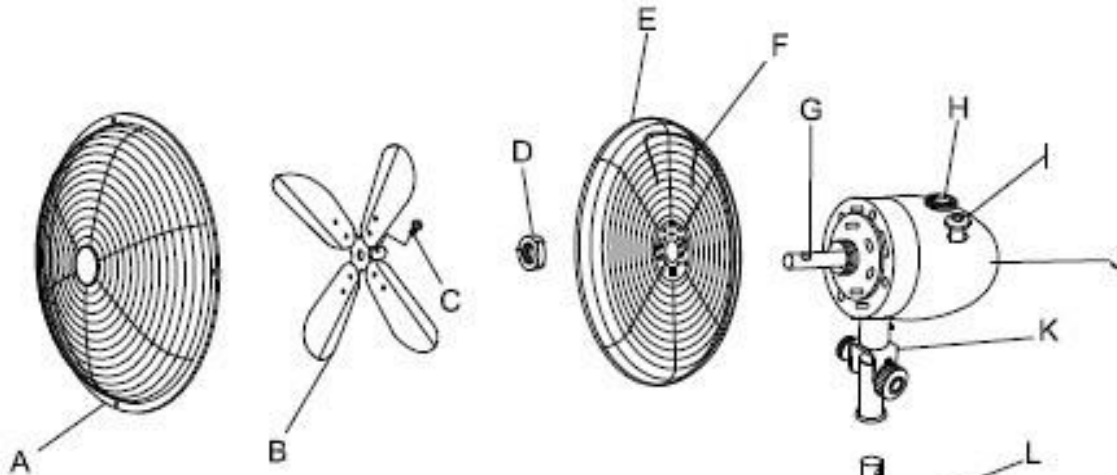

- A) Front Grill
- B) Fan Blade
- C) Securing Screw
- D) Mounting Nut
- E) Back Grill
- F) Carrying Handle
- G) Motor Shaft
- H) Speed Control Knob
- I) Oscillation Knob
- J) Motor Housing
- K) Fan Head Neck
- L) Pole
- M) Adjustable Height Knob
- N) Fan Base
- O) Black Weight
- P) Washer
- Q) Locking Lever
- R) Adjustable Tilt Knob
- S) Range of Motion Screw
- T) Connector
- U) Securing Knob
- V) Carriage Bolt
- W) Securing Screw
- X) Tube Plug

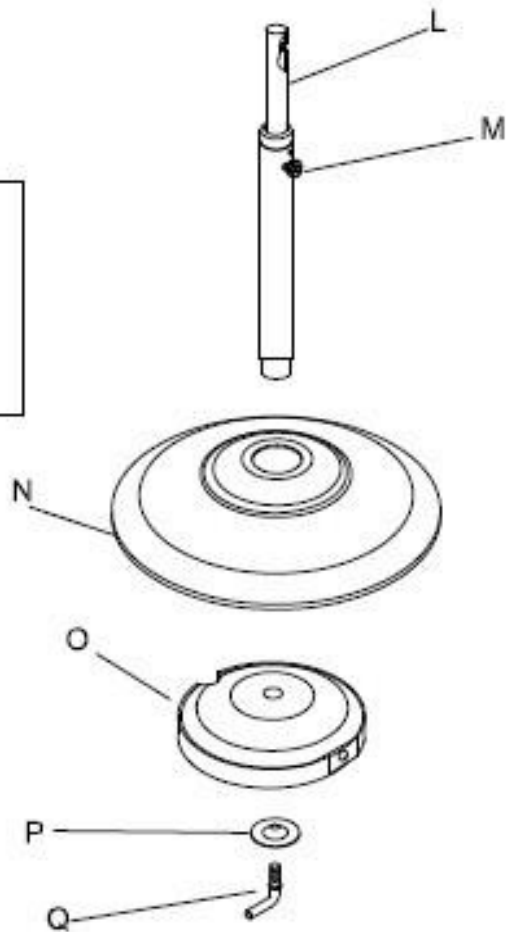
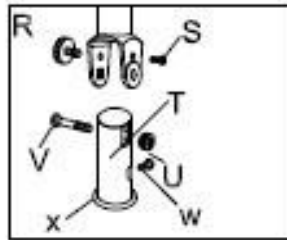

## **ASSEMBLY INSTRUCTIONS**

Tools required: Phillips screwdriver (not included)

- 1) Remove the fan and packaging materials from the box.

### **Base Assembly:**

- 1) Unscrew the locking lever from the bottom of the pole.
- 2) Turn the pole upside down and slide the opening in the center of the fan base over the pole. Place the black weight onto the base followed by the washer.
- 3) Insert the threaded end of the locking lever into the hole of the washer and through the base into the bottom of the stand. Turn the locking lever clockwise to secure and tighten the base to the pole.
- 4) Turn the base over and set it on the floor.
- 5) On the neck of the fan head, remove the securing knob, carriage bolt and adjustable tilt knob. Loosen the range of motion screw.
- 6) Slide the fan head neck over the top of the pole so that the range of motion screw aligns with the range of motion hole.
- 7) Insert the carriage bolt into the square slot on the fan head neck and push through the hole.
- 8) Tighten the range of motion screw. Screw on the securing knob and the adjustable tilt knob.

### **Fan Head Assembly:**

- 1) Remove the black sleeve and mounting nut from the motor shaft.
- 2) Position the back grill over the motor shaft, fitting the holes in the back grill over the knobs that protrude from the motor. Make sure the rear grill fits securely against the motor housing and the handle is at the top.
- 3) Secure the back grill by screwing on the mounting nut. Turn clockwise and tighten firmly.
- 4) Loosen the securing screw on the fan blade. Slide the fan blade onto the mounting shaft with the shaft sleeve facing the motor. Align securing screw with flat groove in the motor shaft and tighten with Phillips screwdriver.
- 5) Remove the small securing bolt from the bottom of the front grill. Position front grill so logo is horizontal and make sure the grill clips are open. Secure the top tab to the back grill. Fasten the grills together with securing bolt. Hold the front grill against the rear grill and snap the grill clips closed to complete the assembly.

## **OPERATING INSTRUCTIONS**

- 1) Set the fan on a stable, level surface.
- 2) Confirm that the Speed Control Knob is set to “O” (off). Plug the cord into a standard 120V A/C outlet.
- 3) Adjust to the desired speed setting:  
O: Off  
I: Low Speed  
II: Medium Speed  
III: High Speed
- 4) The fan can operate in oscillation or stationary mode. Press the Oscillation Knob down to activate the oscillating mode. To stop oscillation, pull knob up.
- 5) Unplug the fan when not in use.

### **Adjustment Instructions:**

- To adjust the angle of the fan head, loosen the adjustable-tilt knob and move the fan head to the desired angle. Firmly tighten the knob to secure into place.
- To adjust the height of the fan, turn the adjustable height knob counter-clockwise to loosen the stand. Adjust the fan to the desired height, then firmly tighten to secure into place.

## **CLEANING/MAINTENANCE**

- Set the Speed Control Knob to off and unplug the unit.
- Clean the fan head, base, and pole using a damp cloth and a mild detergent, if necessary. Make certain all detergent residues are removed.
- Never use abrasive cleaning agents or solvents. This may cause damage or deterioration to the surface of the unit.
- Do not immerse the fan in any form of liquid. Do not allow water to drip on or into the fan motor housing.

### **Fan Blade Cleaning:**

- 1) Make certain the fan is unplugged. Unlock the metal clips on the front grill and remove the front grill. Use a Phillips screwdriver to loosen the securing screw and remove the fan blade.
- 2) The fan blade and grill may be cleaned with a damp cloth and mild detergent.

- 3) Reassemble the fan after the parts have dried completely. To do so, replace the fan blade, tighten the securing screw, and secure the front grill. Do not plug the fan into an electrical outlet until it is fully reassembled.

## **STORAGE**

When not in use, store the fan in a cool, dry location. To prevent dust and dirt build-up, use the old packaging to repack the unit.

Printed in China



## **WARRANTY**

### **One Year Limited Warranty**

Soleus International Inc. warrants the accompanying Soleus Air FSM-45 to be free from defects in material and workmanship for the applications specified in its operation instruction for a period of ONE (1) year from the date of original retail purchase in the United States.

If the unit exhibits a defect in normal use, Soleus International, Inc. will, at its option, either repair or replace it, free of charge within a reasonable time after the unit is returned during the warranty period.

As a condition to any warranty service obligation, the consumer must present this Warranty Certificate along with a copy of the original purchase invoice.

### **This Warranty Does Not Cover**

- 1) Damage, accidental or otherwise, to the unit while in the possession of a consumer not caused by a defect in material or workmanship.
- 2) Damage caused by consumer misuse, tampering, or failure to follow the care and special handling provisions in the instructions.
- 3) Damage to the finish of the case, or other appearance parts caused by wear.
- 4) Damage caused by repairs or alterations of the unit by anyone other than those authorized by Soleus International Inc.
- 5) Freight and Insurance cost for the warranty service.

ALL WARRANTIES, INCLUDING ANY IMPLIED WARRANTY OF MERCHANTABILITY ARE LIMITED TO A ONE-YEAR DURATION OF THIS EXPRESS LIMITED WARRANTY. **SOLEUS INTERNATIONAL, INC.** DISCLAIMS ANY LIABILITY FOR CONSEQUENTIAL OR INCIDENTAL DAMAGES AND IN NO EVENT SHALL SOLEUS INTERNATIONAL INC'S LIABILITY EXCEED THE RETAIL VALUE OF THE UNIT FOR BREACH OF ANY WRITTEN OR IMPLIED WARRANTY WITH RESPECT TO THIS UNIT.

As some states do not allow the limitation or exclusion of incidental or consequential damages, or do not allow limitation on implied warranties, the above limitations and exclusions may not apply to you. This warranty gives you specific legal rights, and you may also have other rights that vary from state to state.

**For Warranty, Technical Support, Customer Service, Missing or Defective Parts, before returning to your retailer, please call (888) 876-5387.**

Or Write To:

Soleus International Inc.  
20035 E Walnut Drive. North  
City of Industry, CA 91789 USA  
[www.soleusair.com](http://www.soleusair.com)