

Thank you for purchasing this Oxford table. Please read the instructions and warnings carefully before use to ensure safe and satisfactory operation of this product.

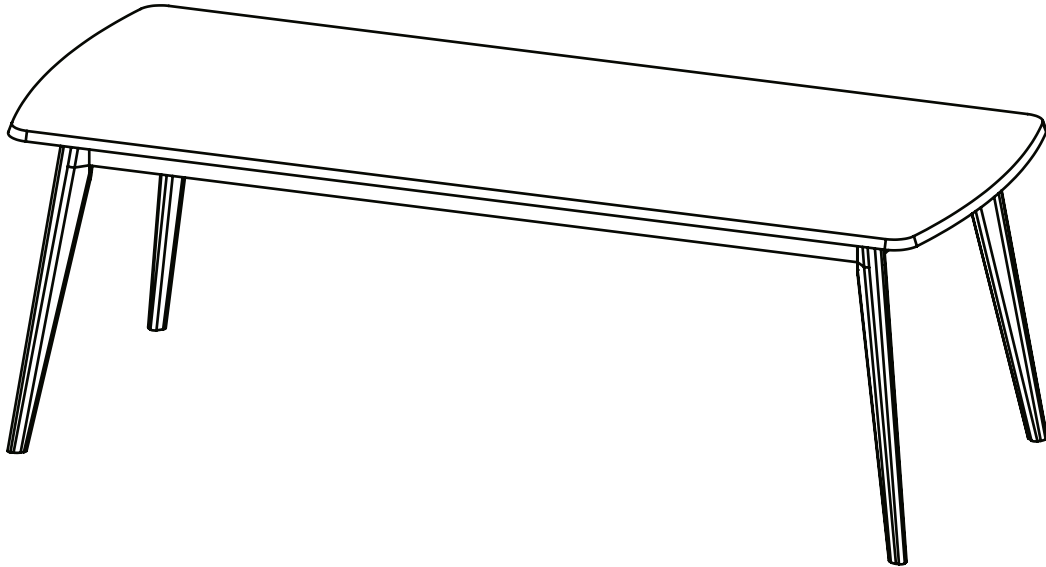
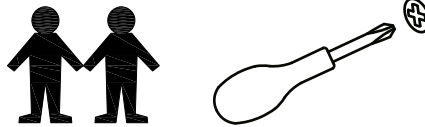

Pre-assembly preparation

Please ensure instructions are read in full before attempting to assemble this product.

Necessary Tools



Please check the pack contents before attempting to assemble this product. A full checklist of components is given in this leaflet. If any components are missing, please contact the retailer from whom you bought this product.

This product is **HEAVY**, it should be assembled as near as possible to the point of use. **TAKE CARE WHEN LIFTING** to avoid personal injury and (or) damage to the product.

This product takes approximately 15 **MINUTES** to assemble with 2 **PEOPLE**.

The fittings pack contains **SMALL ITEMS** which should be **KEPT AWAY FROM YOUNG CHILDREN**.

Read this leaflet in full before commencing assembly.

Parts checklist

Please do not discard any packaging until you are sure that you have all the parts.

A: Top frame x1

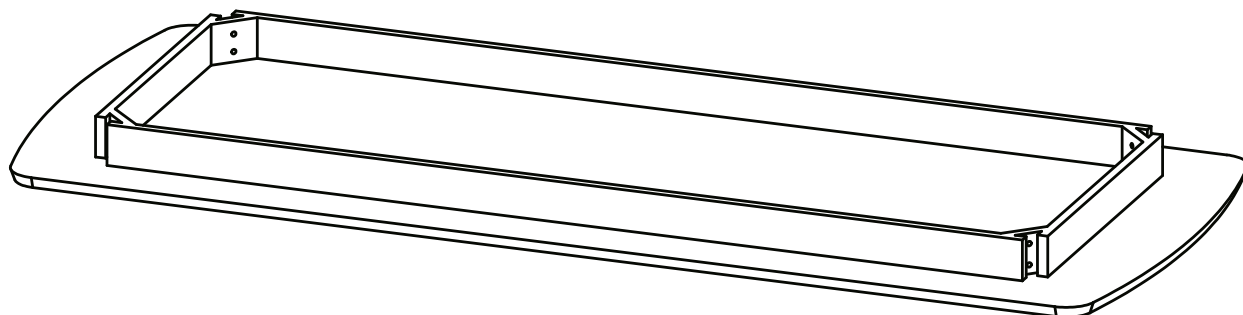

B: Leg x 4

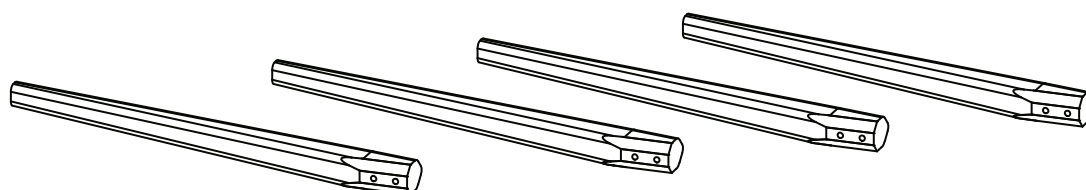

Fitting checklist

① screw x 8

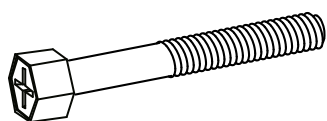

② Spring washer x 8



③ Washer x 8



Step1 Carefully put top on soft surface. and insert legs as shown.

Use screw driver to fix legs by 8x screw ① 8x spring washer ② 8x washer ③ and tighten them!

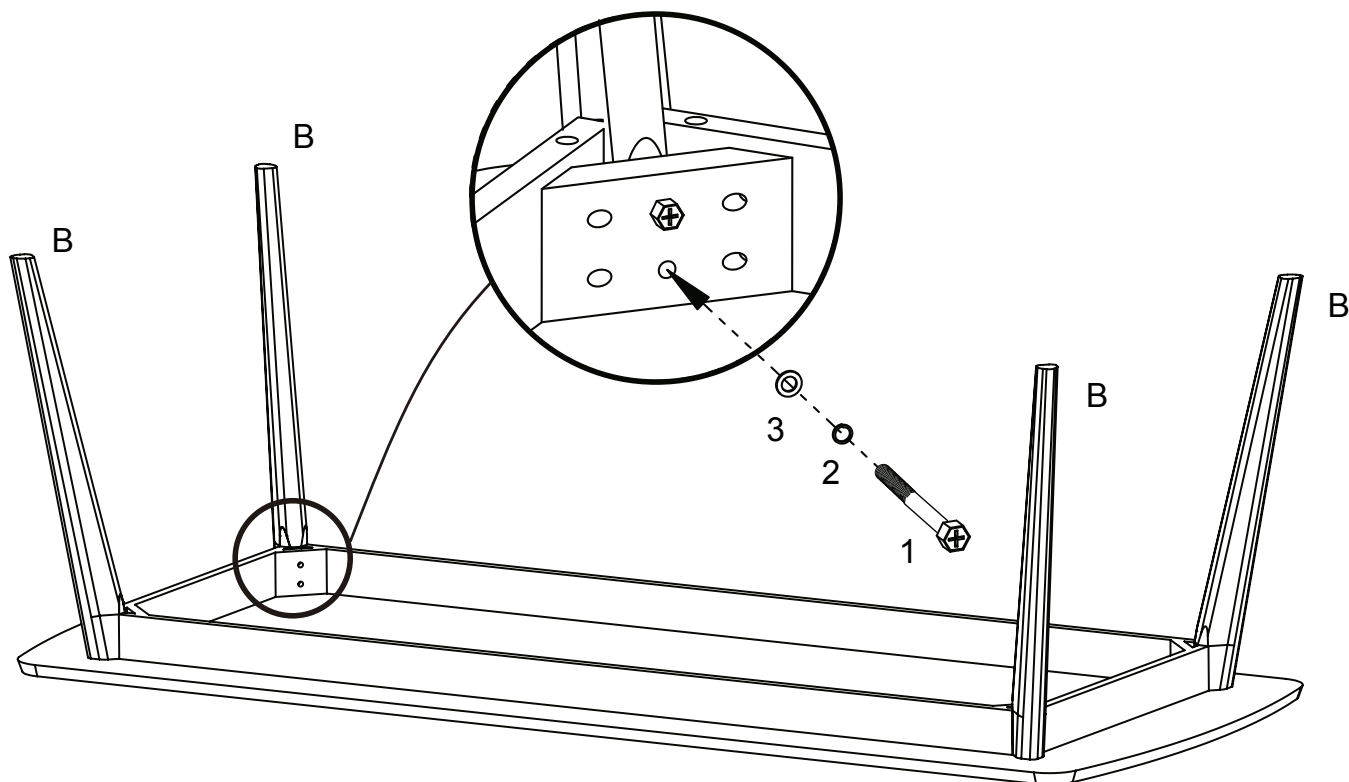

Step2 Carefully turn around table by 2 people. Pls make sure 4 legs touch floor at same time.

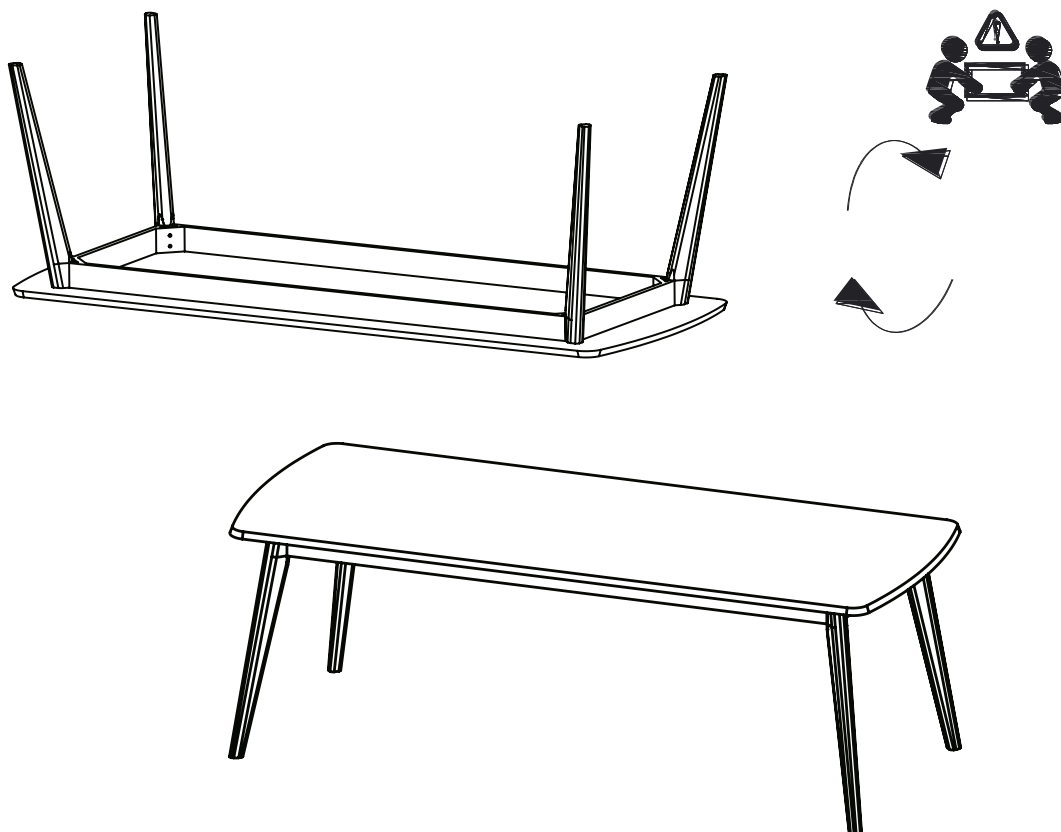

Care and Maintenance

Wood Furniture

Wood displays different grain patterns depending on which way they cut - for example, the 'medullary ray' which can appear on oak furniture is a mark of good quality timber - these are just characteristics of the natural beauty of the wood. Some furniture is also deliberately aged and rustic.

Wood veneers also allow distinctive patterns to be created on flat surfaces, such as table tops and drawer fronts by the way the slivers are arranged.

All timber surfaces will change colour and mellow over time. New furniture will initially vary in shade from items that have been previously purchased.

How to care for your wood furniture

Furniture with a hard lacquer, wax polish or painted surface should be dusted with a dry cloth.

Spray polishes are best avoided as they contain silicones which may spoil the furniture's surface by building up over time.

Make sure all surfaces are protected from heat and liquids by mats and coasters. Wipe up spills immediately and ensure that a mat or pad is placed under paper if you are writing.

Our furniture will endure most temperatures in the home but it is best to avoid placing furniture next to heat sources such as radiators or fires. Be particularly careful with solid wood as the lack of humidity caused by central heating can cause damage such as warping

Safety Instructions

General warnings:

Never drag furniture when moving it, always lift it.

Periodically check all fixings to ensure none have come loose and re-tighten where necessary. Please take care when handling or moving the furniture as careless handling may cause damage or injury.

Furniture can be dangerous if incorrectly installed. Assembly should be carried out by a competent person. No liability will be accepted for damage or injury caused by incorrectly installed or assembled furniture.

Specific warnings for heavy items:

It is recommended that before moving heavy objects to a new location they are completely disassembled to avoid personal injury or damage to the furniture. Please be careful to retain all fittings when doing this.

PLEASE KEEP THESE INSTRUCTIONS FOR FUTURE REFERENCE