

GIJS BOERENKAST

Bauernschrank • Farmer cabinet • Armoire agriculteur

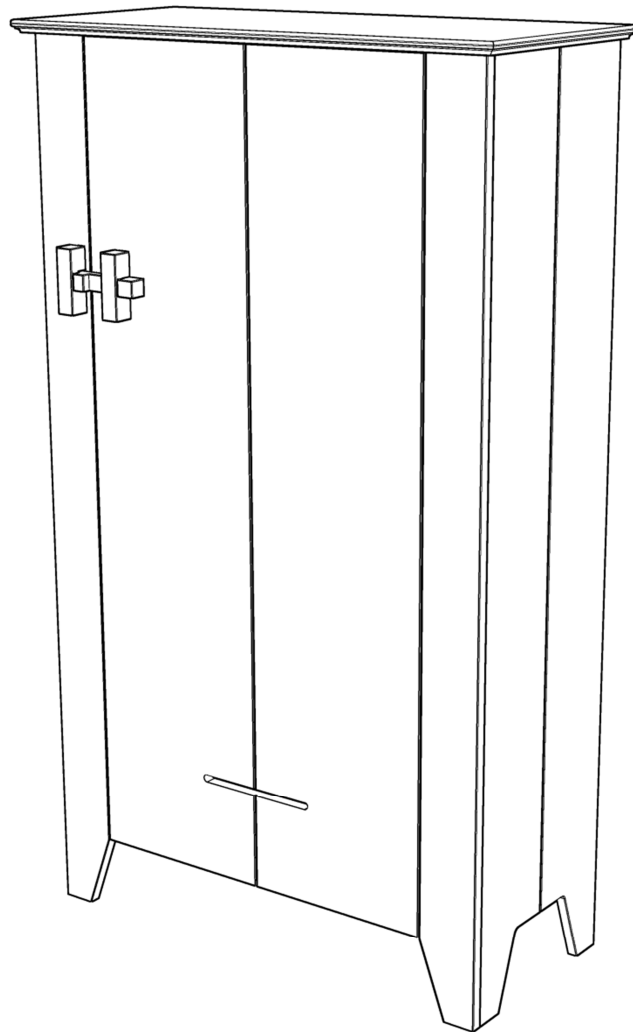

MADE BY
wood

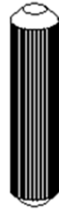

24mm	Ø15	8x35mm	3,5x35	Ø 1,4x25mm
103	102	601	219	350
34x	34x	24x	16x	50x

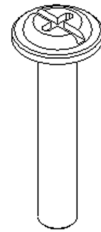
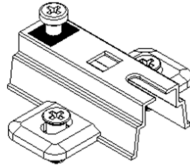
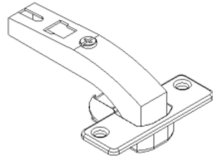
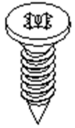

4x16	STOL	2mm	Ø14mm	M4x22,5
204	433	448	369/375/378	212
4x	2x	2x	24x	4x

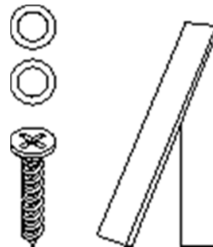
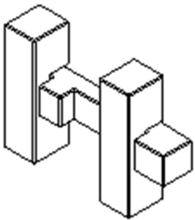

	safty balance
568	356
1x	1x

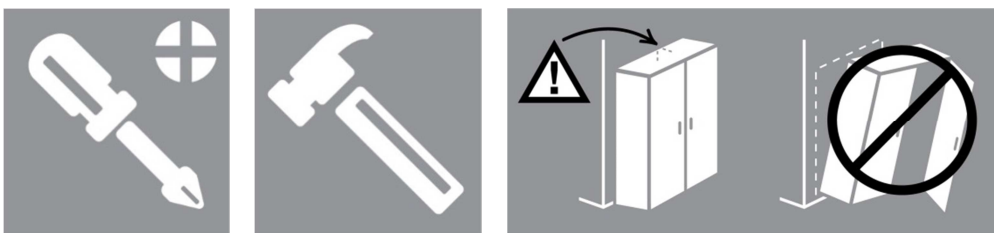
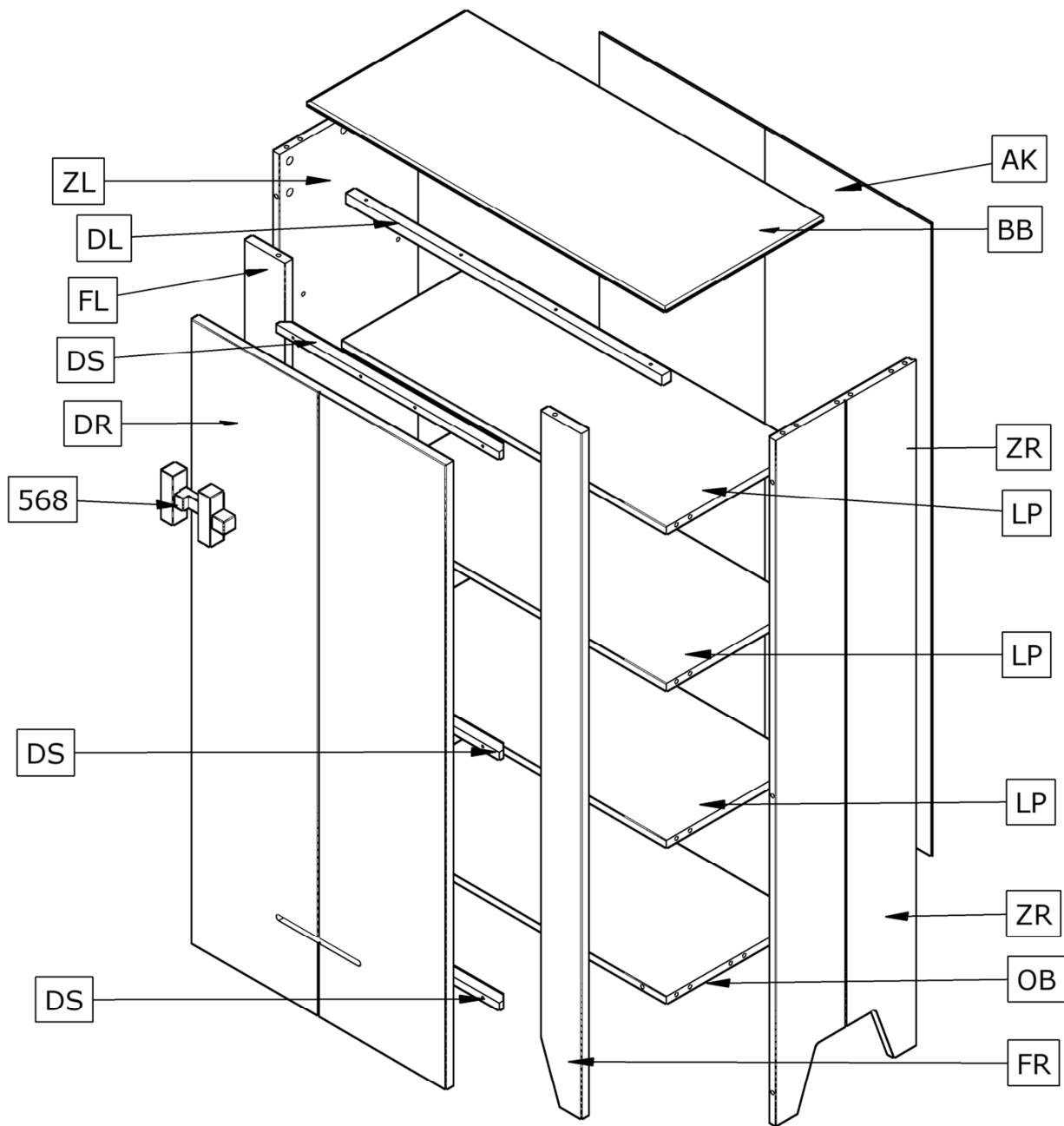

1.

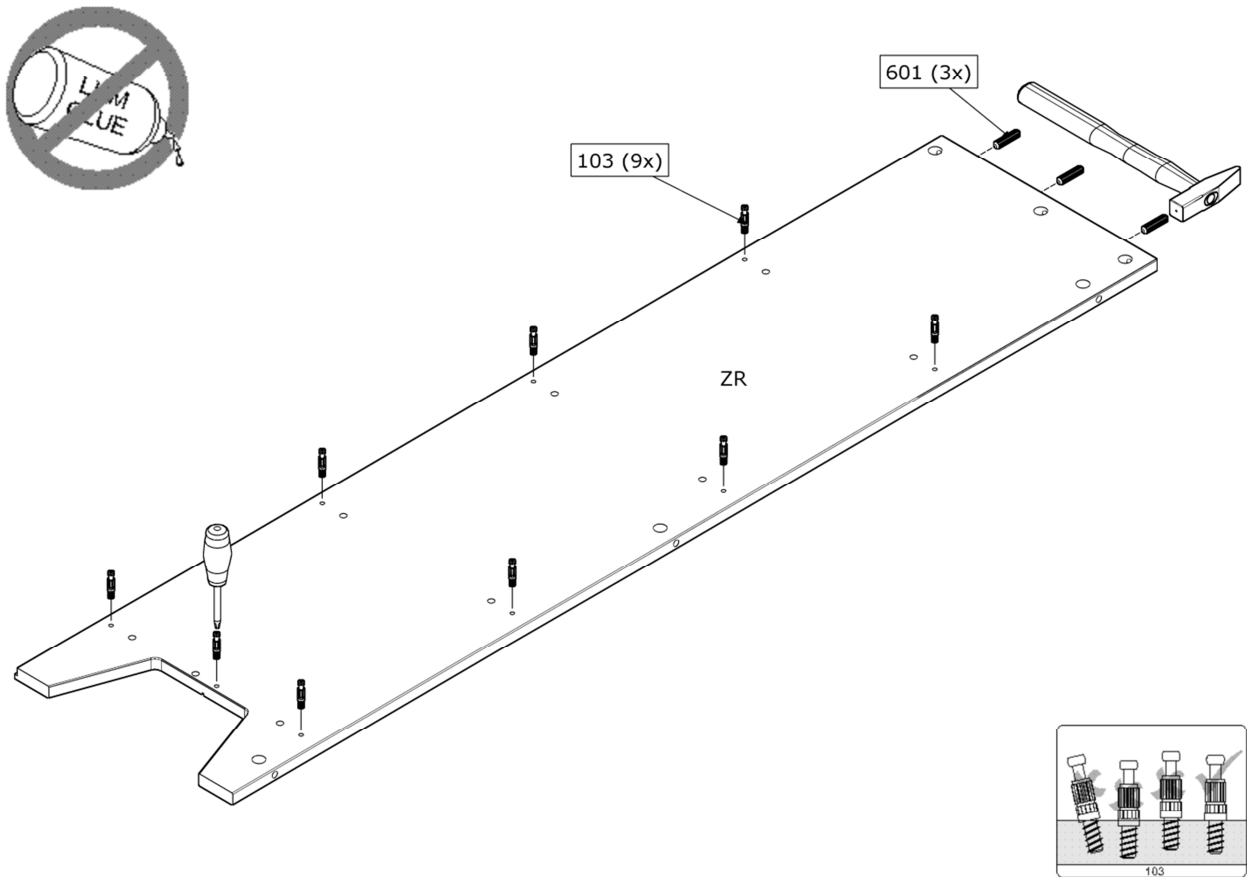

2.

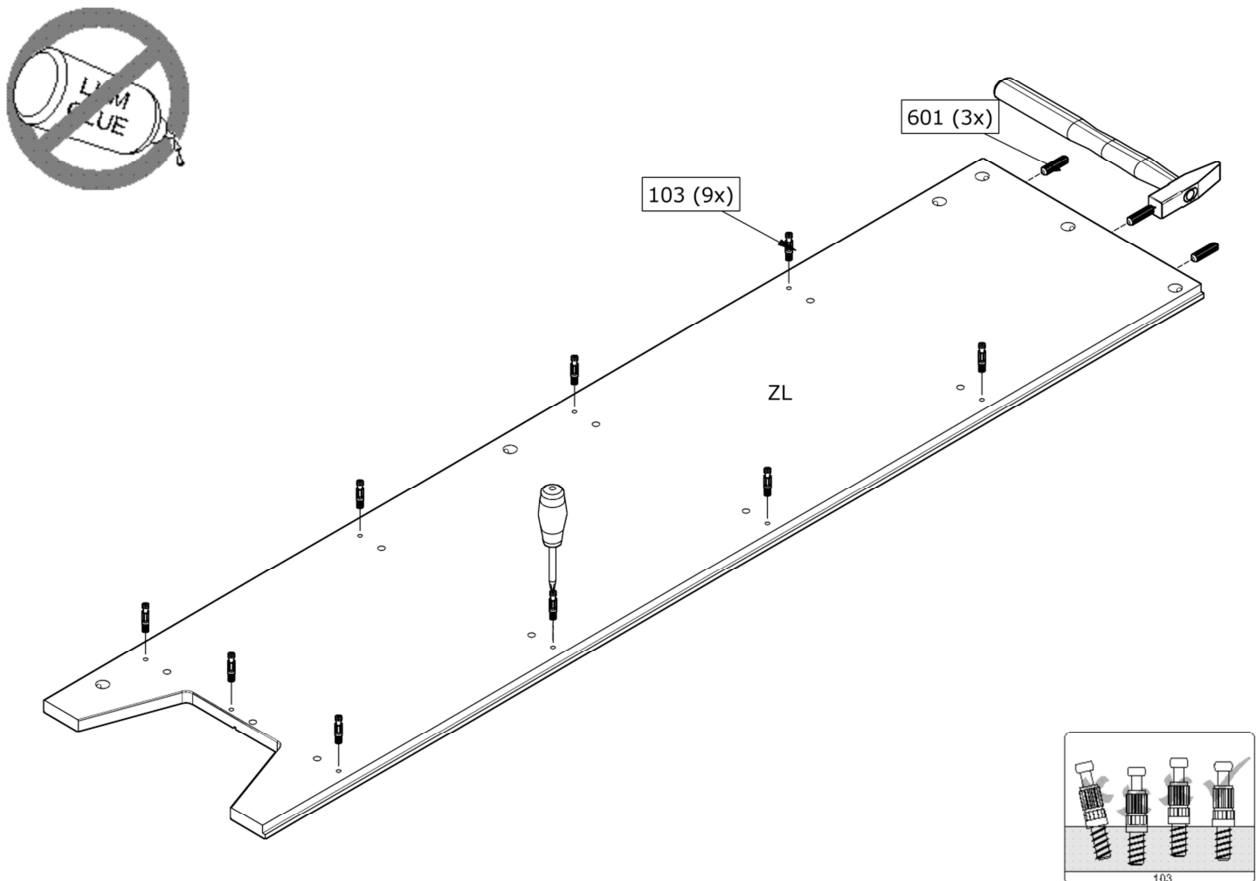

3.

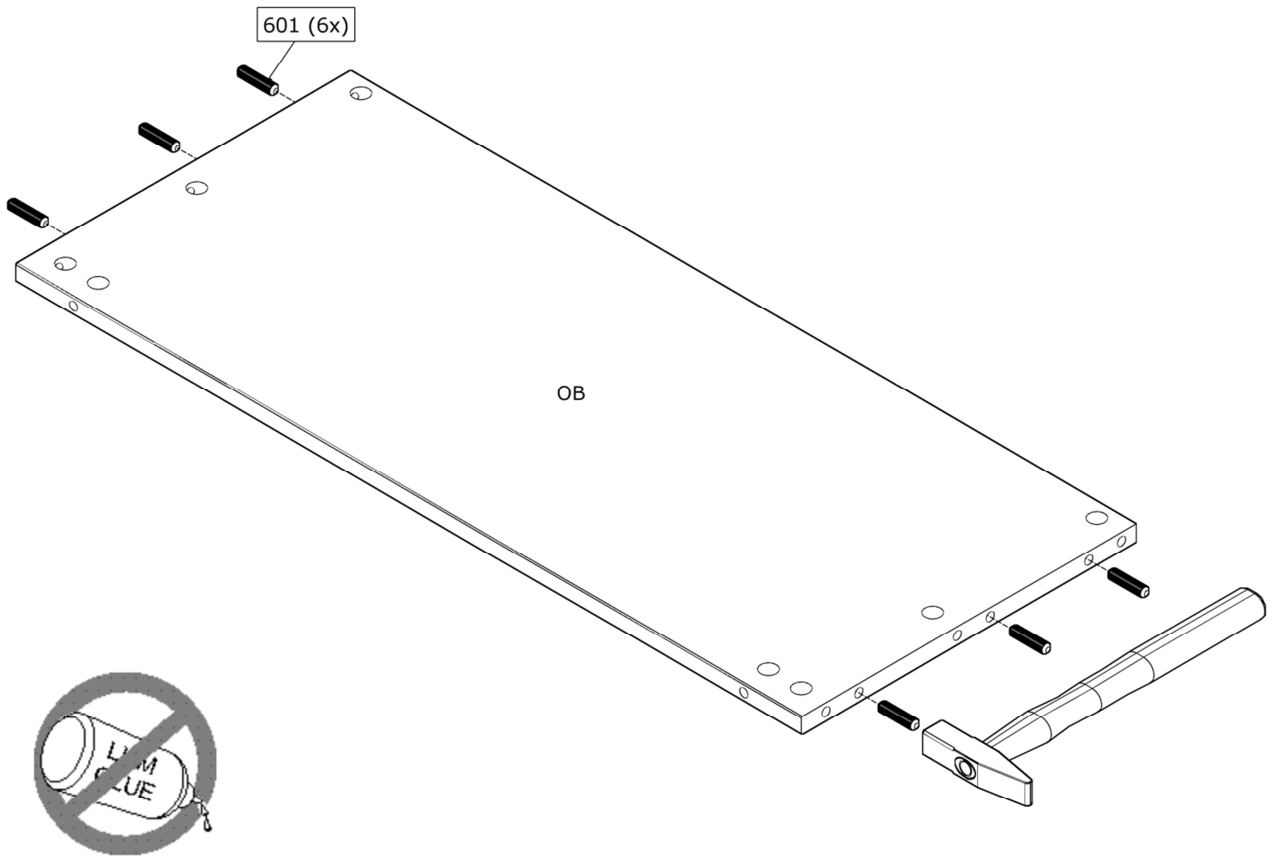

4.

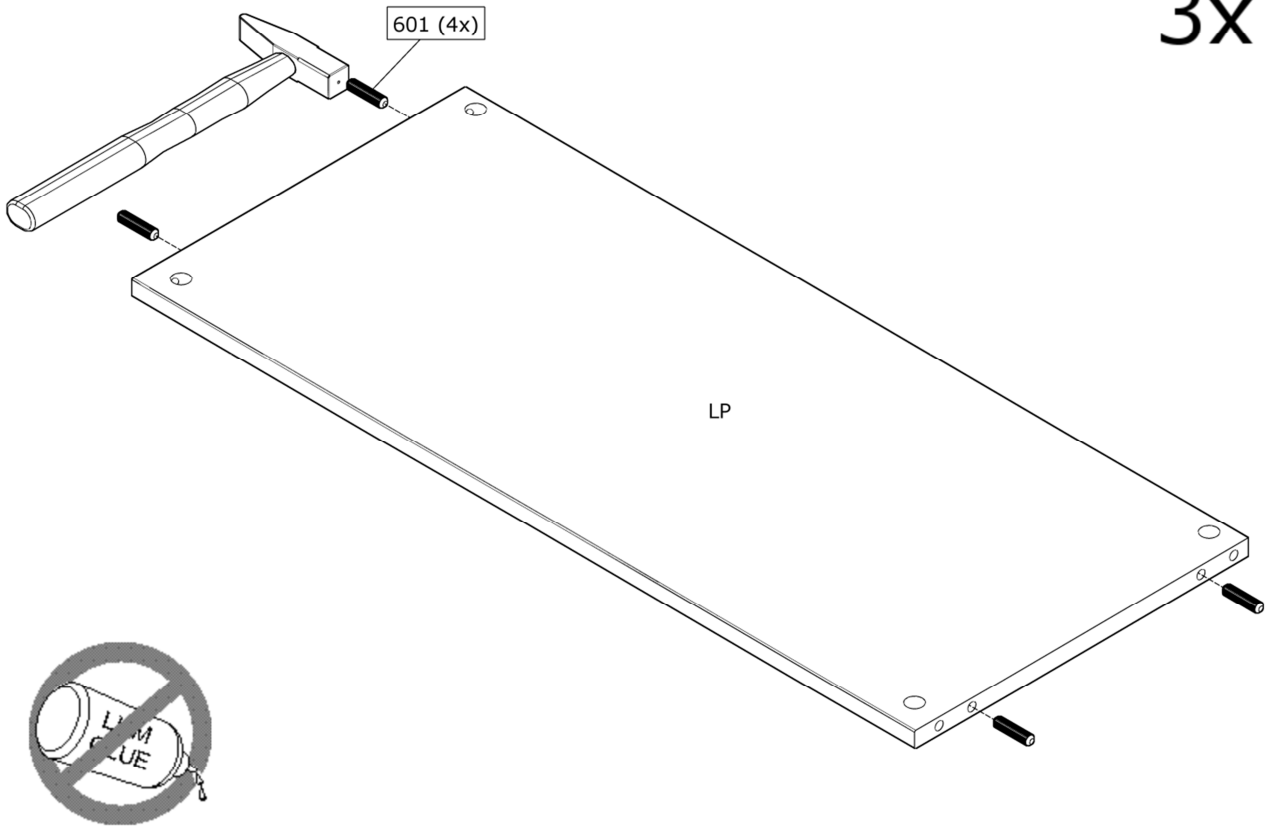

3x

5.

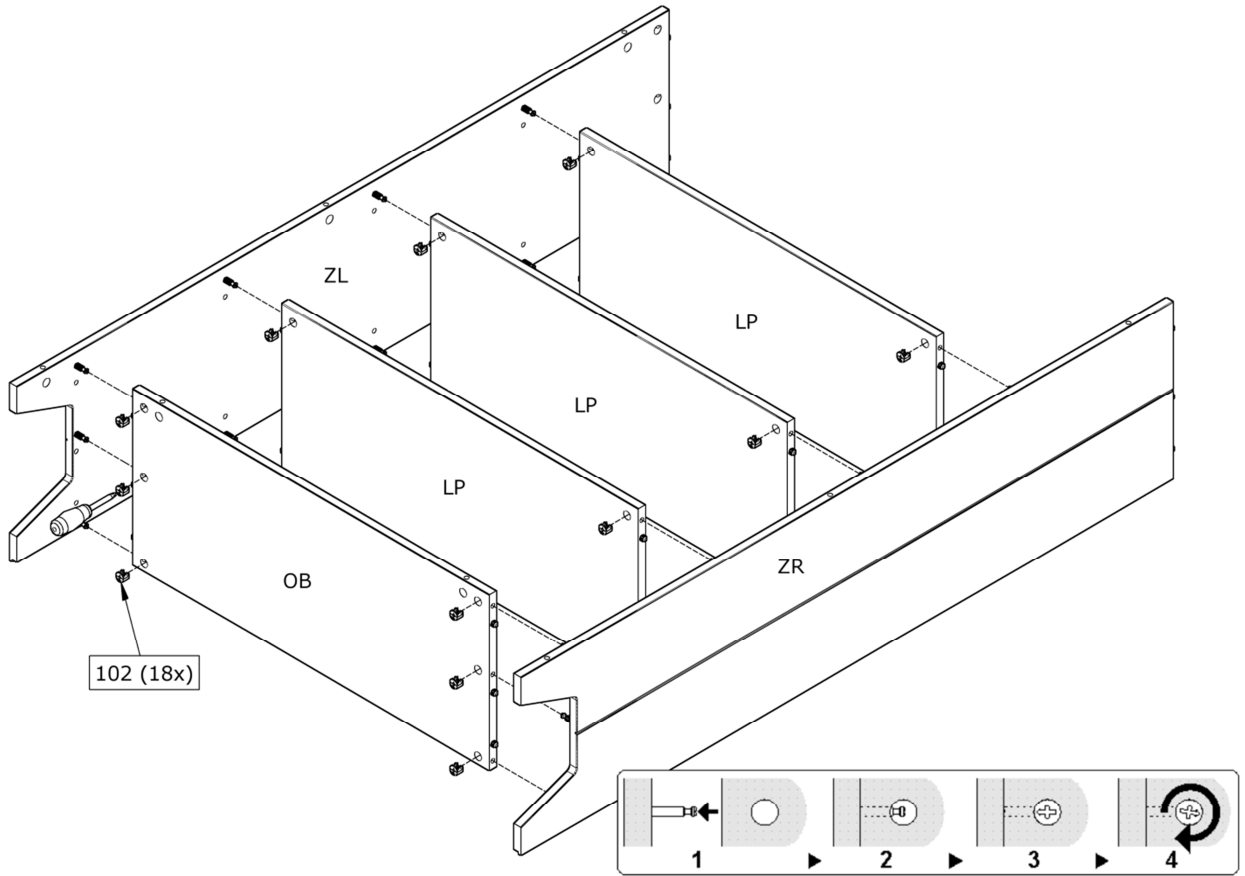

6.

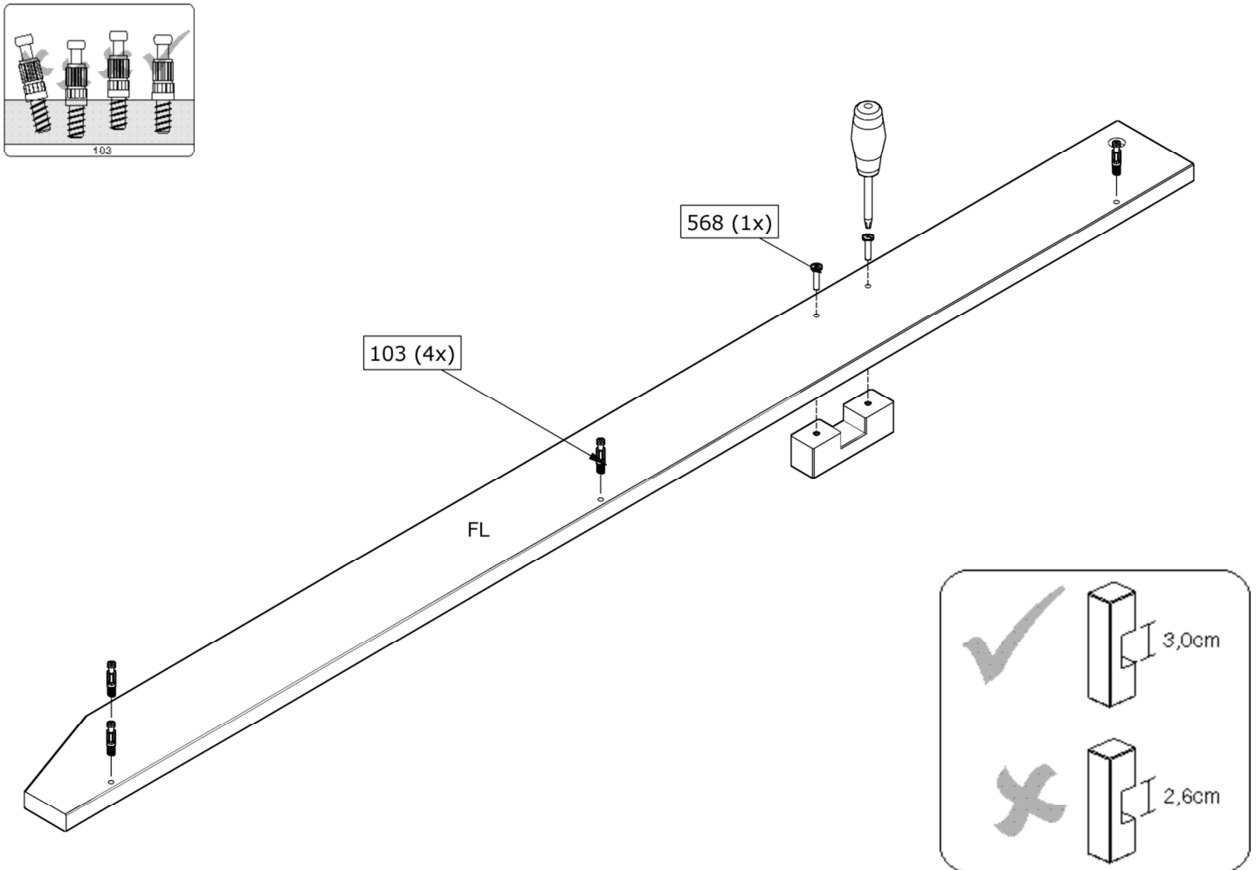

7.

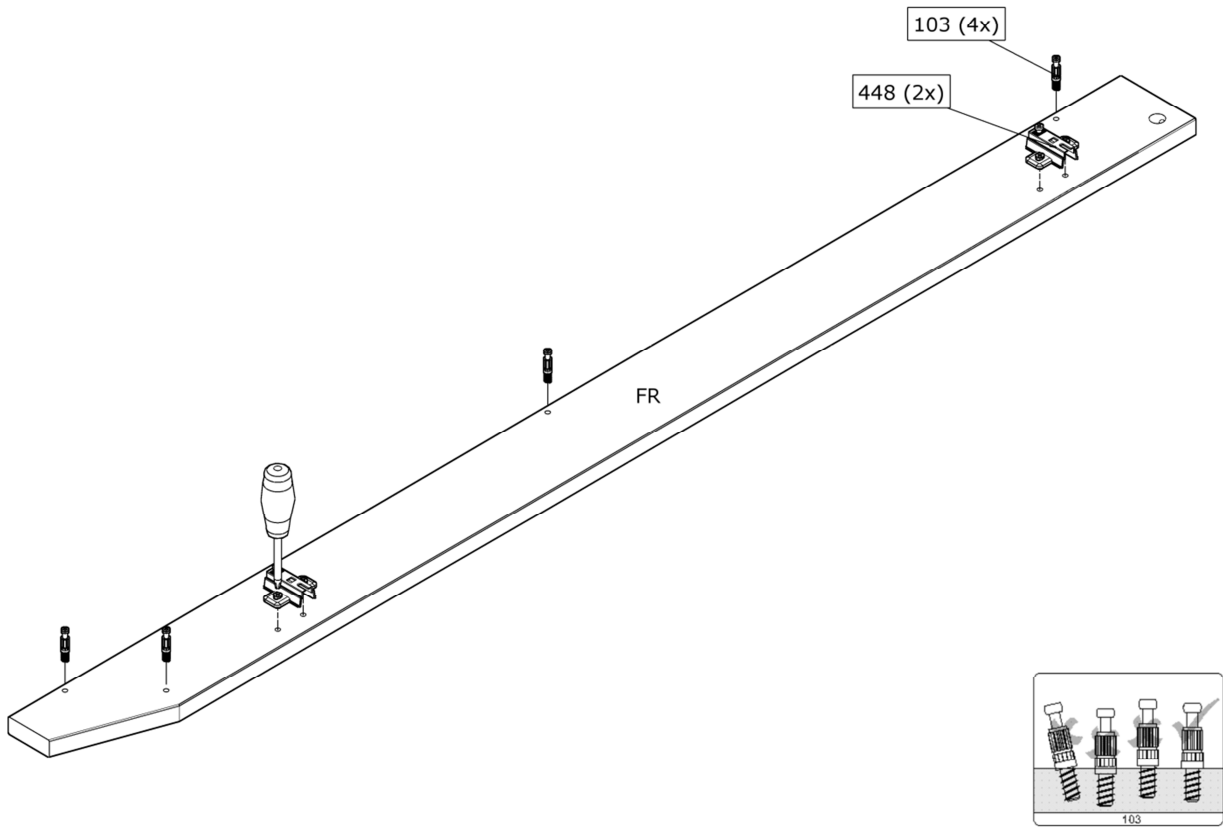

8.

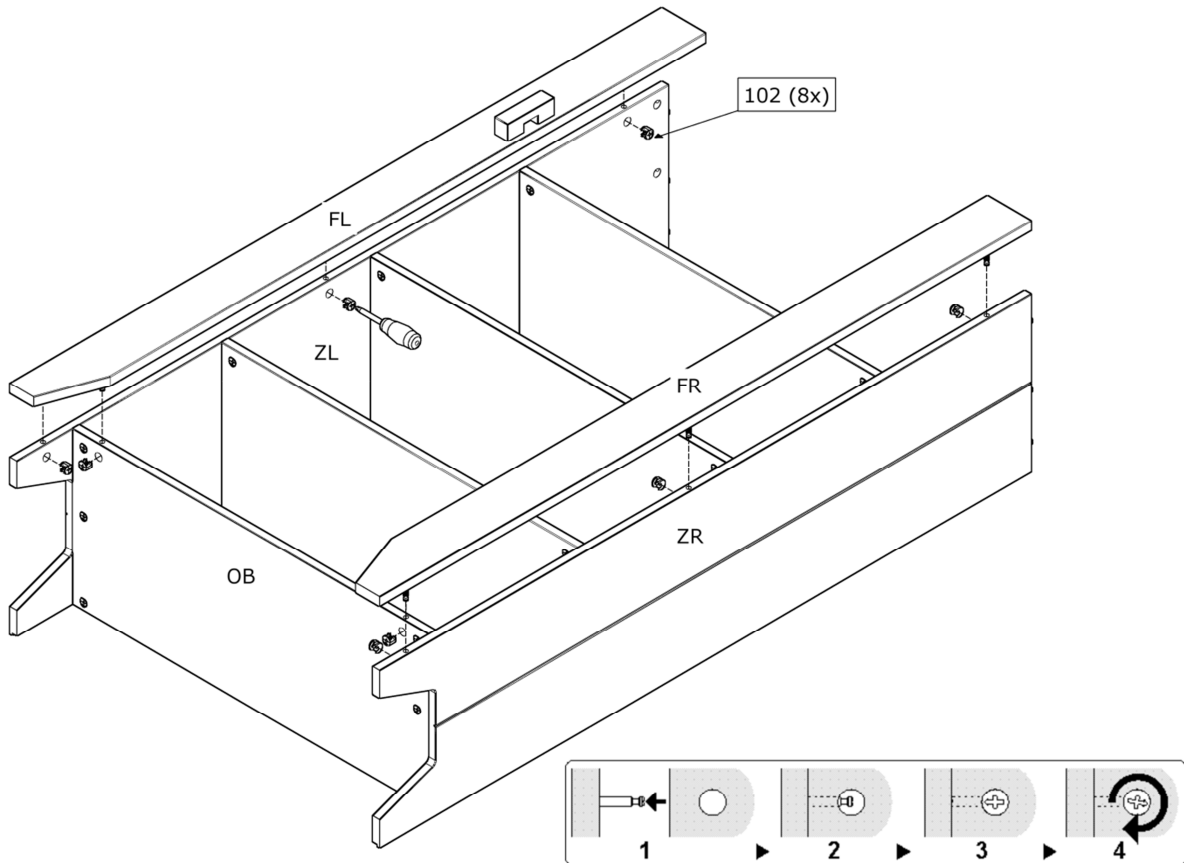

9.

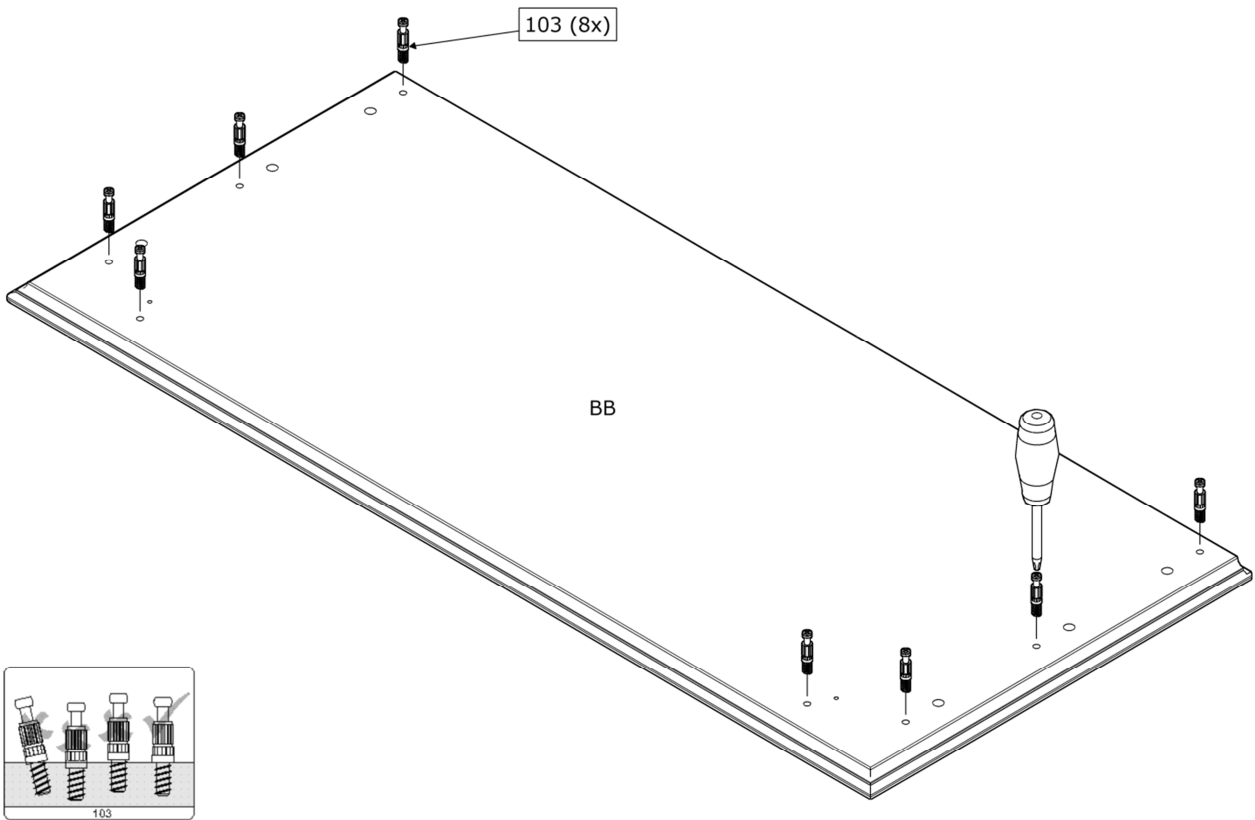

10.

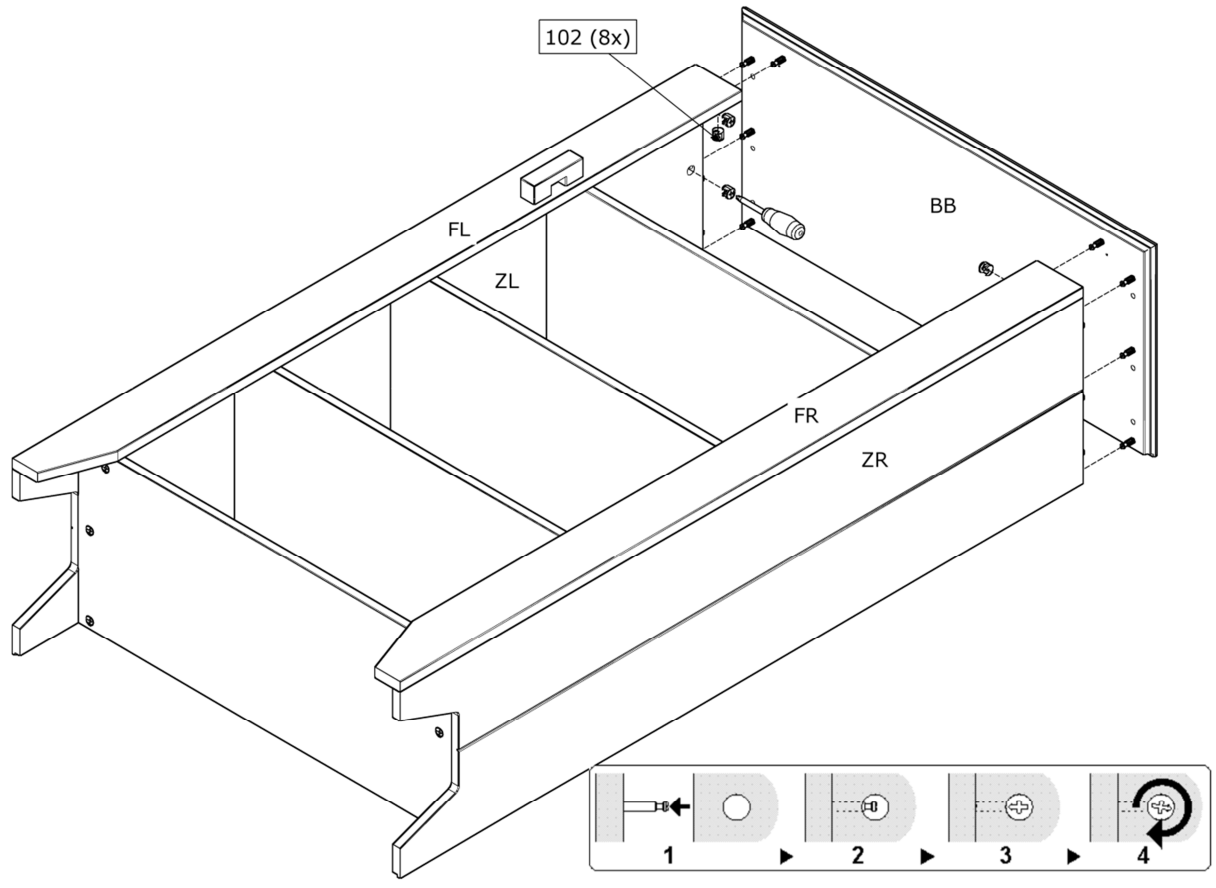

11.

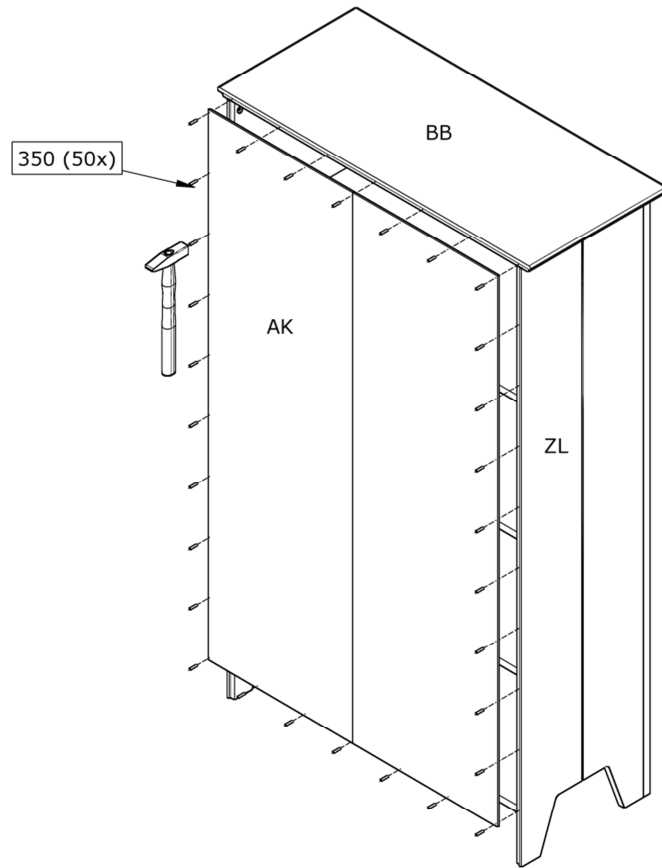

12.

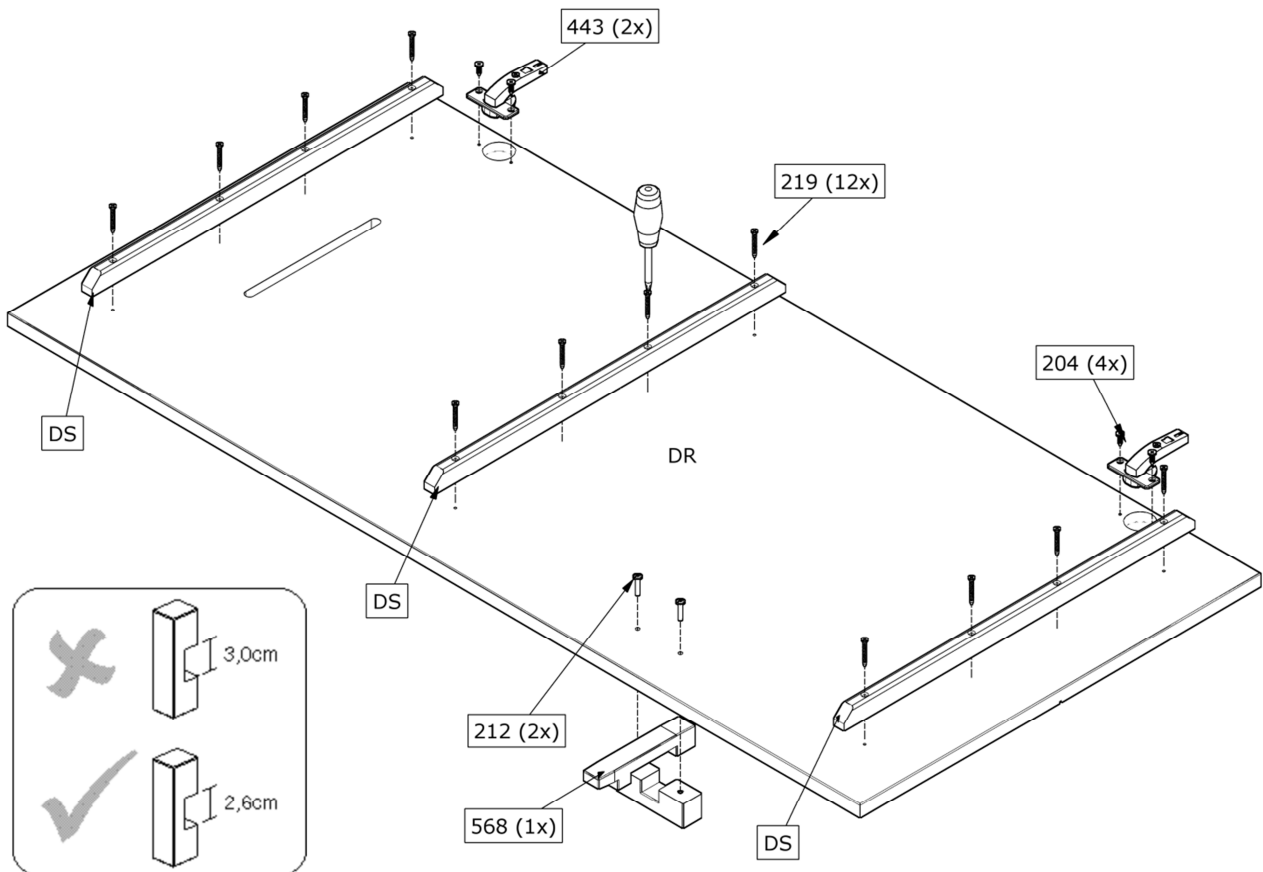

13.

Stol scharnier

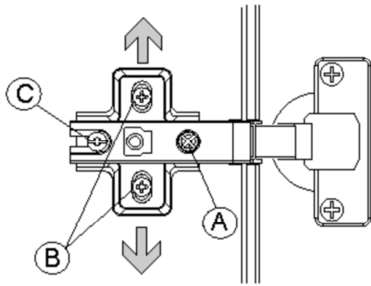

A. Met deze schroef stelt u de deur in de diepte af.
B. Door deze schroeven iets los te draaien kunt u de scharnierplaatjes verstellen zodat de deuren hoger of lager bevestigd kunnen worden.
C. Deze schroef gebruiken wanneer u de kieren tussen de deuren en beide zijden groter of kleiner wilt hebben.

A. mit dieser Schraube kann man, wenn nötig, die Tür etwas nach innen oder nach aussen drehen.
B. Wenn Sie diese Schrauben ein wenig lösen, können Sie die Scharnierplatten verstellen, um so die Tür höher oder niedriger zu befestigen.
C. Diese Schraube benutzen, wenn der Spalt zwischen der Tür und den Seiten größer oder kleiner sein soll.

A. Cette vis vous permet d'ajuster la profondeur de la porte.
B. En desserrant légèrement ces vis, vous pouvez ajuster la position des charnières pour fixer les portes plus vers le haut ou vers le bas.
C. Utilisez cette vis lorsque vous souhaitez augmenter ou réduire les interstices entre la porte et chacun des côtés.

A. With this screw you can change the depth of the doors
B. By releasing this screw the position of mounting plates of the hinges can be repositioned so that vertical position of doors can be adjusted (higher/lower)
C. Adjusting this screw will position doors horizontally (changes gap between doors)

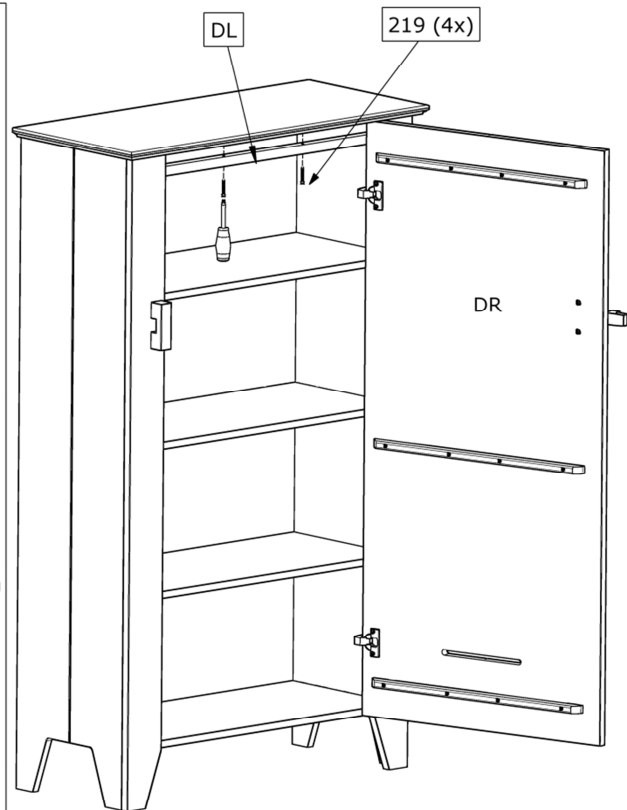

SOCIAL MEDIA

We are curious about the result! Would you like to share it with us? Use #WOOOD on social media.

Wir sind gespannt auf das Ergebnis! Möchten Sie es mit uns teilen? Benutzen Sie #WOOOD in Social Media.

Nous sommes impatient de connaître le résultat. Souhaitez-vous le partager avec nous? Utilisez #WOOOD sur les médias sociaux.



facebook.com/wood.nl
twitter.com/madebywood
instagram.com/madebywood
pinterest.com/madebywood