

Aimee

The **Aimee** is stylishly designed with the best features of any great whirlpool bathtub. The Aimee comfortably fits two and features armrests at both ends of the tub for added bathing comfort. The Aimee also has two fully recessed jumbo rotating jets.

Available Sizes:

72"L x 36"W x 24"D
 95 Gallons



Acrylic Tub – construction features

Acrylic models finished in 1/8" thick layer of deep lustrous acrylic.
Extra thick reinforced fiberglass.
Pre-wired pump on pump platform (standard pump location only)
Integral E-Z Level platform facilitates installation.

PVC Systems – include:

4 Fully directional adjustable PVC jets
2 Rotating adjustable flow PVC jets
Anti-vortex safety suction.
Color matched system trim
HydrOzone ozone sanitation system
Rigid PVC piping
Self draining pump and system
Soft Touch electronic on/off control with 30-min. integral timer
2.25 HP Single Speed Pump
Cable waste & overflow

Hydro Systems – Options:

Available as Tub only, Thermal Air, Whirlpool or Combo
Microban Antibacterial Protection
Extra High Density Fiberglass
Available less Jet recess (TO; TAS)
Custom jet and pump locations
Plated Metallic finish
Additional directional Jets
Swirling, Rotating, or Jumbo Jets
Micro Therapy Jet
Integral Waste & Overflow
1.5 HP Variable Speed Pump (digital temperature display optional)
Electronic low water protection
In-line Heater
Chromatherapy-LED Lighting System
Chromatherapy-LED Mini Spotlights
Mood Light
Grab Bars

Neck Masseur Pillow
Hydro Fusion
Hydro Coat
Hydro Express quick ship

Approvals & Listings

Commonwealth of Massachusetts
 UPC & USPC - US & Canada



Aimee

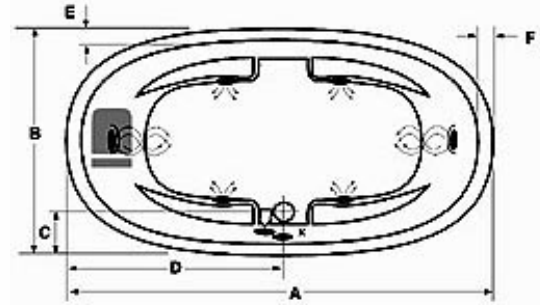





PVC SYSTEM SHOWN

Must be set in Mortar Base



Edge Detail

-  Pump motor
-  Jets
-  Anti-vortex suction
-  Overflow location

AS SHOWN:
Whirlpool option w/ standard jets

ALSO AVAILABLE:
Soaking Tub Only,
Thermal Air, Combo

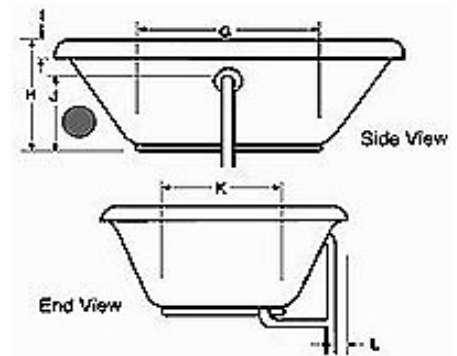

Model	GC	AC	A	B	C	D	E	F	G	H	I	J	K	L	Jet	Pump	Wat.Cap.
7236	N/A		72"	36"	10½"	36"	3½"	3½"	47"	24"	2½"	21"	21"	1½"	6	2.25	95 gal.
Amp		Volt		Breaker		Dedicated Service											
13.5		120		20 amps		GFCI Protected											

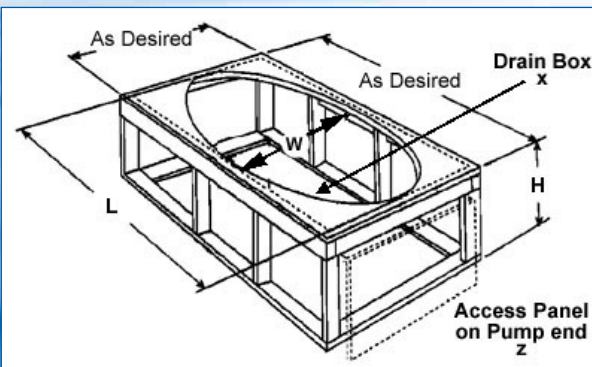

Island Drop-In			
Model	(L)ength	(W)idth	(H)eighth Finish
7236	70"	34"	22½"

Disclaimer: Certain options or altering the pump/blower location may cause the pump/blower to extend beyond the tub decking. For cutout dimensions wait for unit to arrive. All specifications subject to change without notice.