

Lara

With a symmetrical design, a trio of backrests and ample room, the Lara is the answer for the ultimate in personal bathing with room for two if desired. With the built in armrests and spacious interior, relaxation and rejuvenation is just a soak away in the Lara.

Available Sizes:

60"L x 60"W x 19"D
 70 Gallons



Acrylic Tub – construction features

Acrylic models finished in 1/8" thick layer of deep lustrous acrylic.

Extra thick reinforced fiberglass.

Pre-wired pump on pump platform (standard pump location only)

Integral E-Z Level platform facilitates installation.

Non-skid bottom.

PVC Systems – include:

6 Fully directional adjustable PVC jets

Anti-vortex safety suction.

Color matched system trim

Hydrozone ozone sanitation system

Rigid PVC piping

Self draining pump and system

Soft Touch electronic on/off control with 30-min. integral timer

2.25 HP Single Speed Pump

Cable waste & overflow

Hydro Systems – Options:

Available as Tub only, Thermal Air, Whirlpool or Combo

Microban Antibacterial Protection

Extra High Density Fiberglass

Flange molded

Custom jet and pump locations

Plated Metallic finish

Additional directional Jets

Swirling, Rotating, or Jumbo Jets

Micro Therapy Jet

Integral Waste & Overflow

1.5 HP Variable Speed Pump (digital temperature display optional)

Electronic low water protection

In-line Heater

Chromatherapy-LED Lighting System

Chromatherapy-LED Mini Spotlights

Mood Light

Grab Bars

Back Masseuse

Neck Masseuse Pillow

Hydro Fragrance

Hydro Fusion

Hydro Coat

Hydro Express quick ship

Approvals & Listings

Commonwealth of Massachusetts
 UPC & USPC - US & Canada







Lara

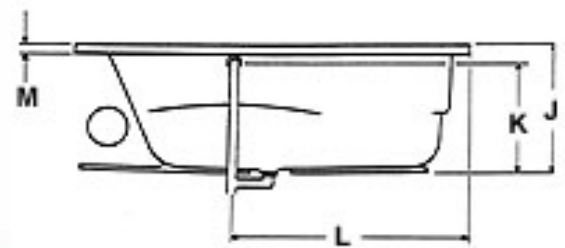
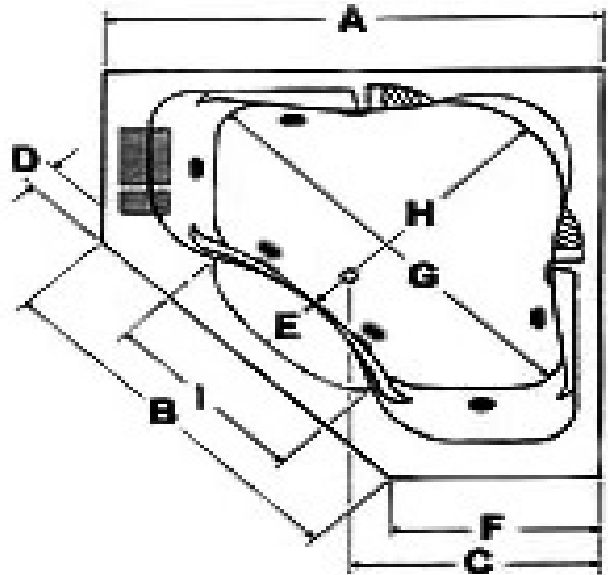

Must be set in Mortar Base



-  Pump motor
 -  Jets
 -  Anti-vortex suction
 -  Overflow location
- AS SHOWN:
Whirlpool option w/ standard jets
- ALSO AVAILABLE:
Soaking Tub Only, Whirlpool,
Thermal Air, Combo

Model	GC	AC	A	B	C	D	E	F	G	H	I	J	K	L	M	Jet	Pump	Wat.Cap.
6060	N/A		60"	50"	29"	3½"	7¾"	24"	53"	33"	27¼"	19"	16½"	34"	1¾"	6	2.25	70gal.
Amp	Volt	Breaker	Dedicated Service															
13.5	120	20 amp	GFCI Protected															

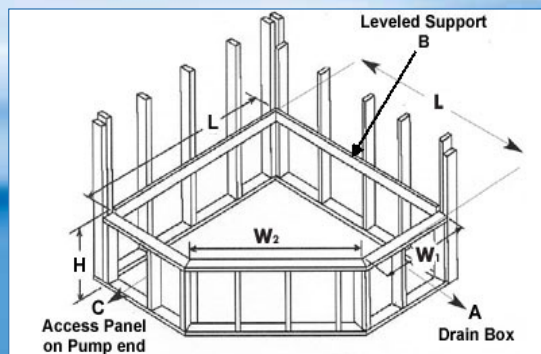

Corner Installation				
Model	(L)ength	(W)idth 1	(W)idth 2	(H)eight Finish
6060	58"	22½"	50"	18¼"

*Disclaimer: Certain options or altering the pump/blower location may cause the pump/blower to extend beyond the tub decking.
 For cutout dimensions wait for unit to arrive.
 All specifications subject to change without notice.*