

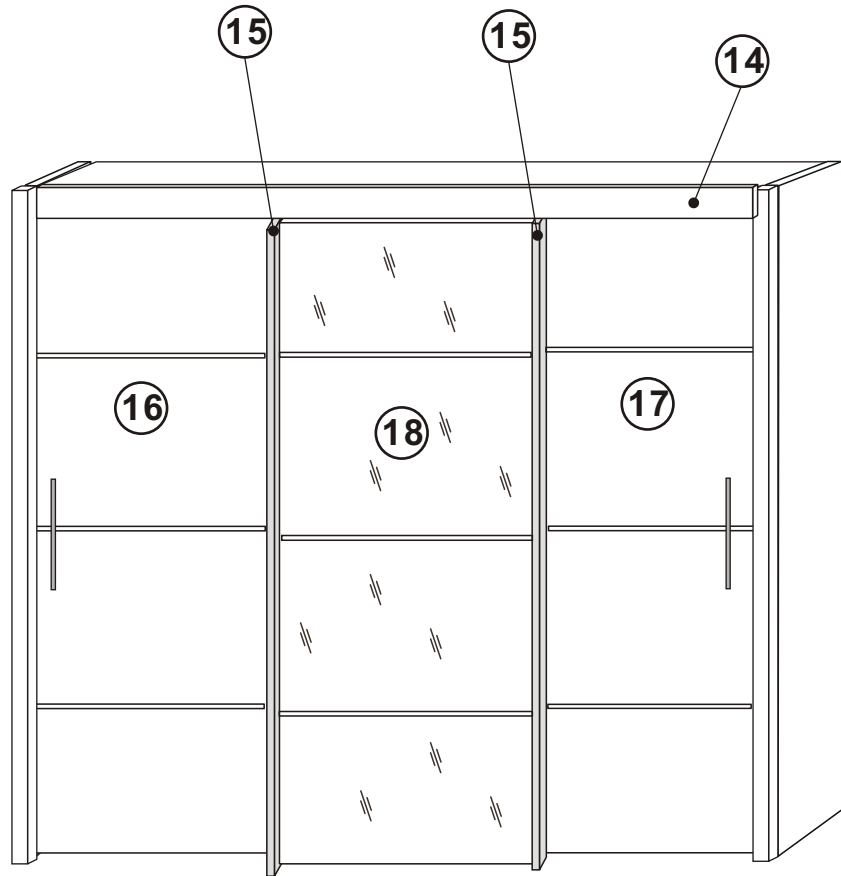

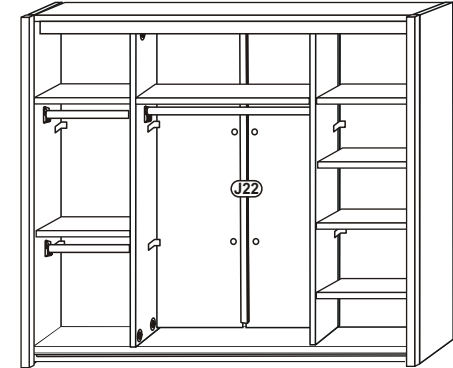

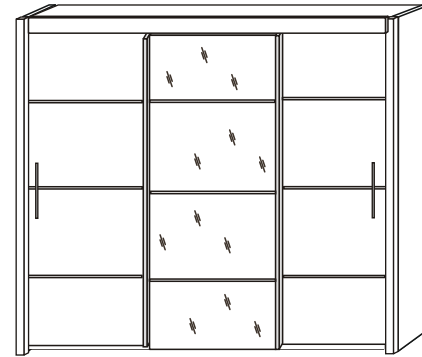

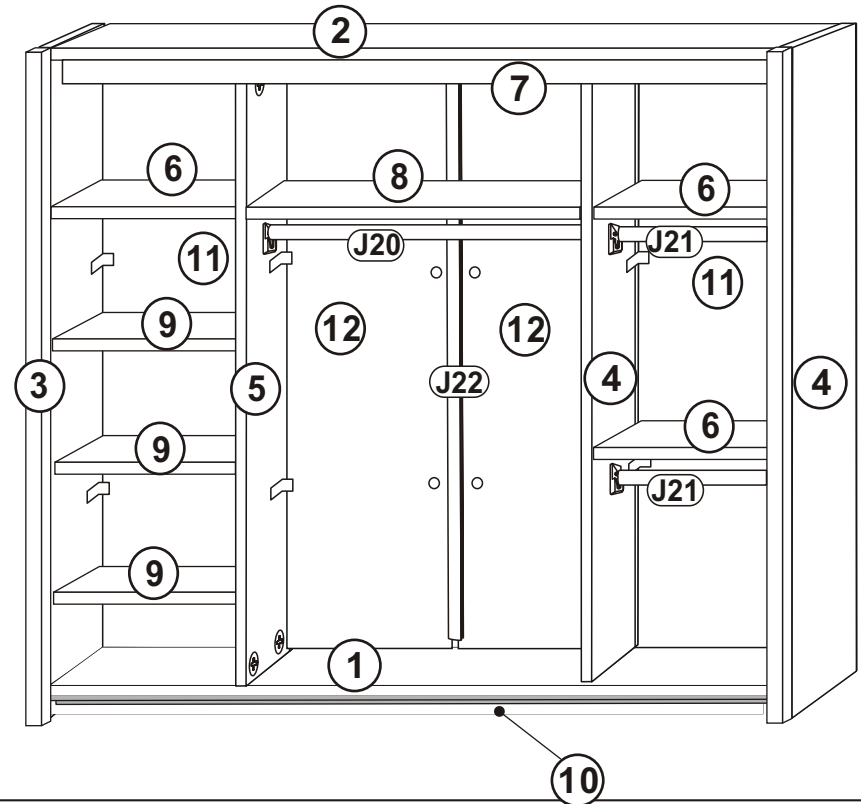

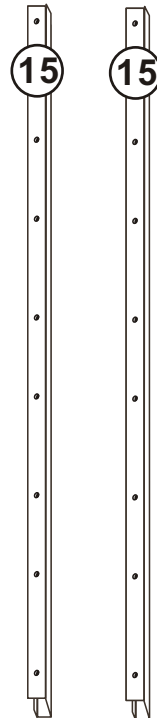















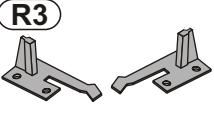
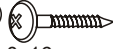
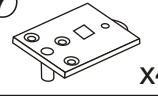

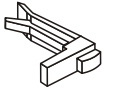
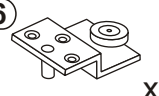

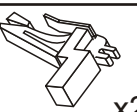
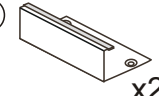

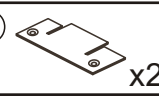
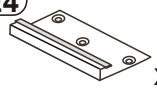

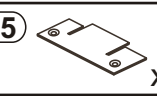

option "b"

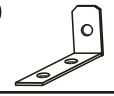

option "a"

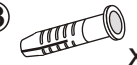

<p><b>1</b></p> <p><b>T6</b>  x16</p> <p><b>M1</b>  x21</p> <p><b>T1</b>  x21</p> <p><b>B1</b>  8x28 x18</p> <p><b>K1</b>  7x50 x4</p> <p><b>C1</b>  2 x2</p> <p><b>P16</b>  4,2x12 x14</p> <p><b>M6</b>  x14</p> <p><b>C2</b>  Ø15 x16</p> <p><b>C3</b>  Ø10 x6</p> <p><b>W1</b>  x12</p> <p><b>L1</b>  x1</p> <p><b>A1</b>  M4x20 x10</p>	<p><b>2</b></p> <p><b>F7</b>  x6</p> <p><b>S3</b>  3,0x13 x6</p> <p><b>C11</b>  2 x2</p> <p><b>R3</b>  x(1+1)</p> <p><b>P3</b>  4,0x16 mm x4</p>	<p><b>3</b></p> <p><b>E7</b>  x4</p> <p><b>E2</b>  4,0x13 x12</p> <p><b>R2</b>  x2</p> <p><b>R1</b>  x2</p>	<p><b>4</b></p> <p><b>E6</b>  x2</p> <p><b>E2</b>  4,0x13 x6</p> <p><b>R2</b>  x2</p>	<p><b>5</b></p> <p><b>E3</b>  x2</p> <p><b>E1</b>  6,3x11 x4</p> <p><b>E5</b>  x2</p>	<p><b>6</b></p> <p><b>E4</b>  x4</p> <p><b>E1</b>  6,3x11 x8</p> <p><b>E5</b>  x4</p>	<p><b>7</b></p> <p><b>U10</b>  L=256 x2</p> <p><b>A5</b>  M4x40 x4</p> <p><b>S3</b>  3,0x13 X(8+8)</p> <p><b>L4</b>  x3</p> <p><b>L5</b>  x2</p>	<p><b>8</b></p> <p><b>J11</b>  x2</p> <p><b>P13</b>  3,5x13 mm x4</p> <p><b>T13</b>  x2</p> <p><b>S15</b>  x2</p>
---	---	---	--	--	--	---	--

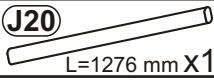
**J20**  L=1276 mm X1

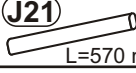
**J21**  L=570 mm x2

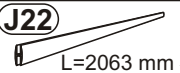
**J22**  L=2063 mm X1

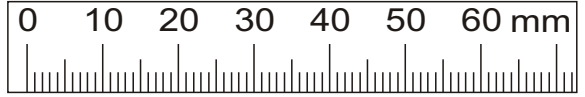



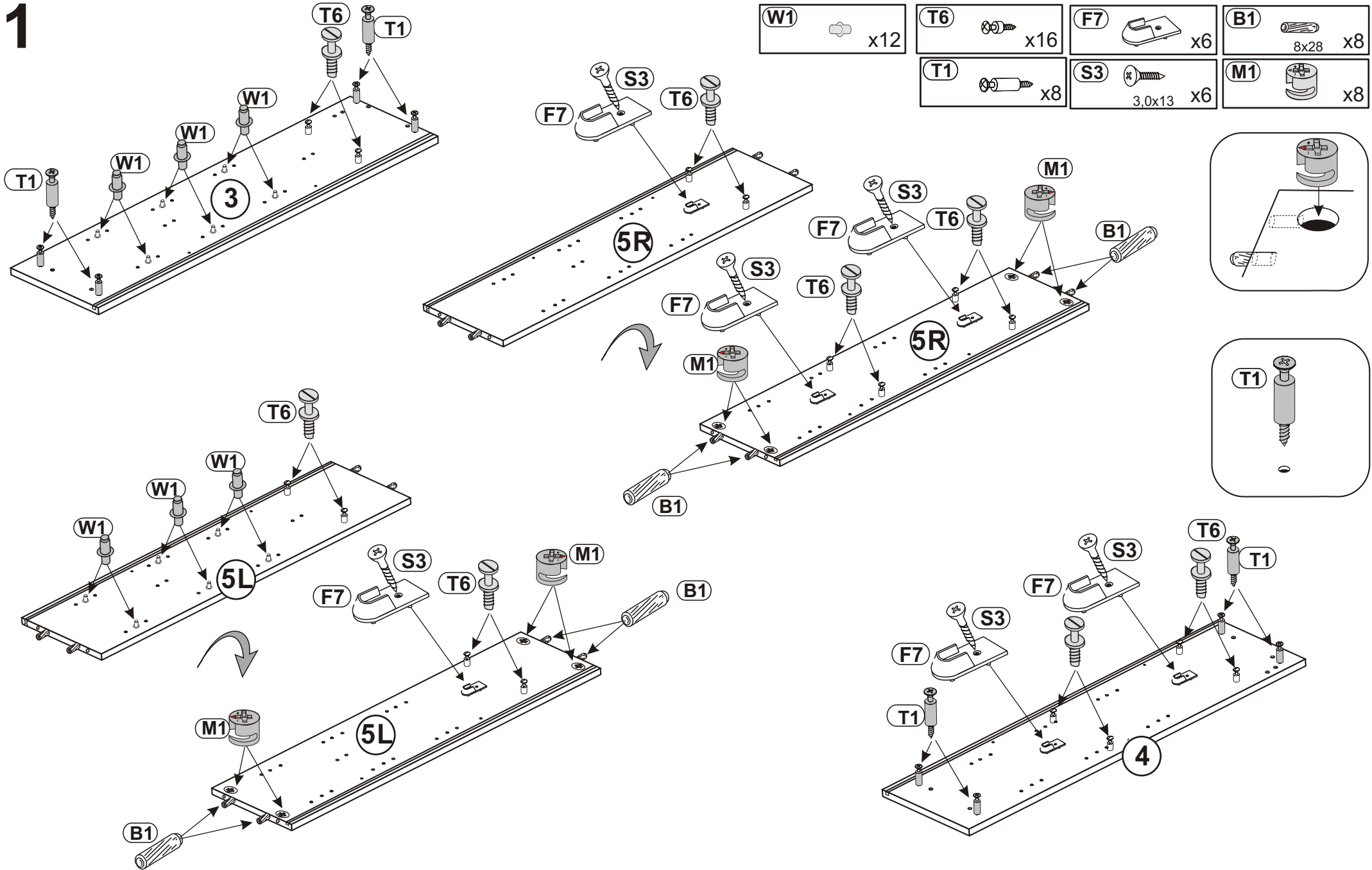

# 1

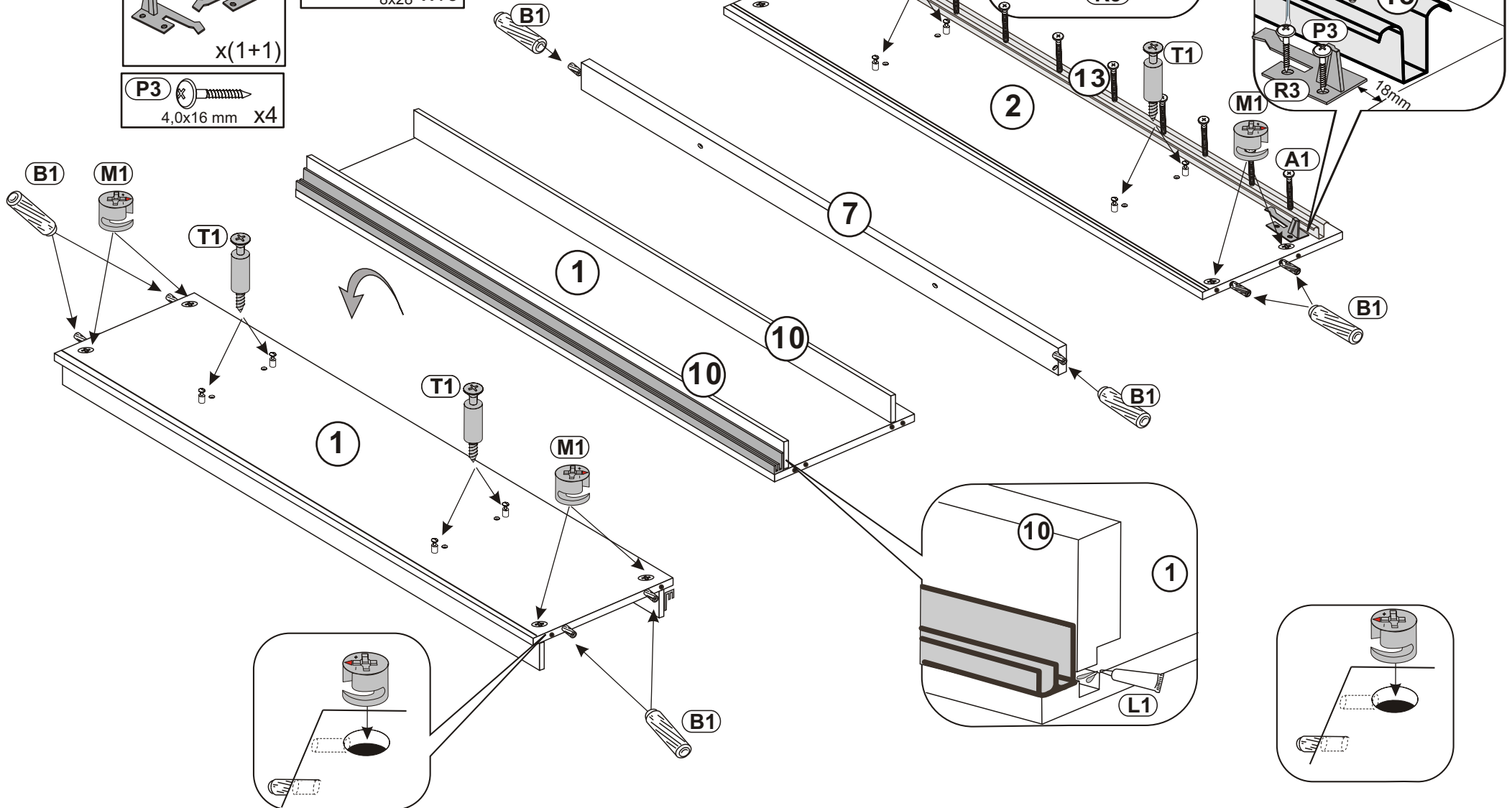
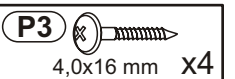
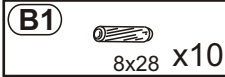
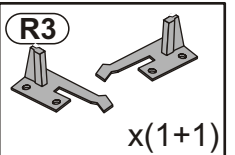
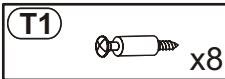
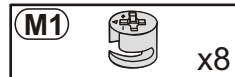

## 2



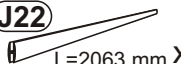

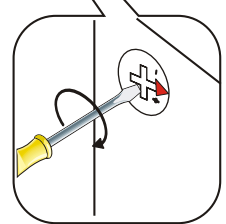
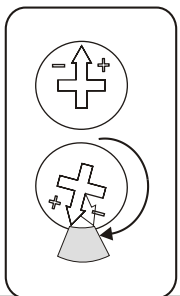
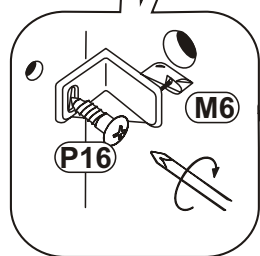
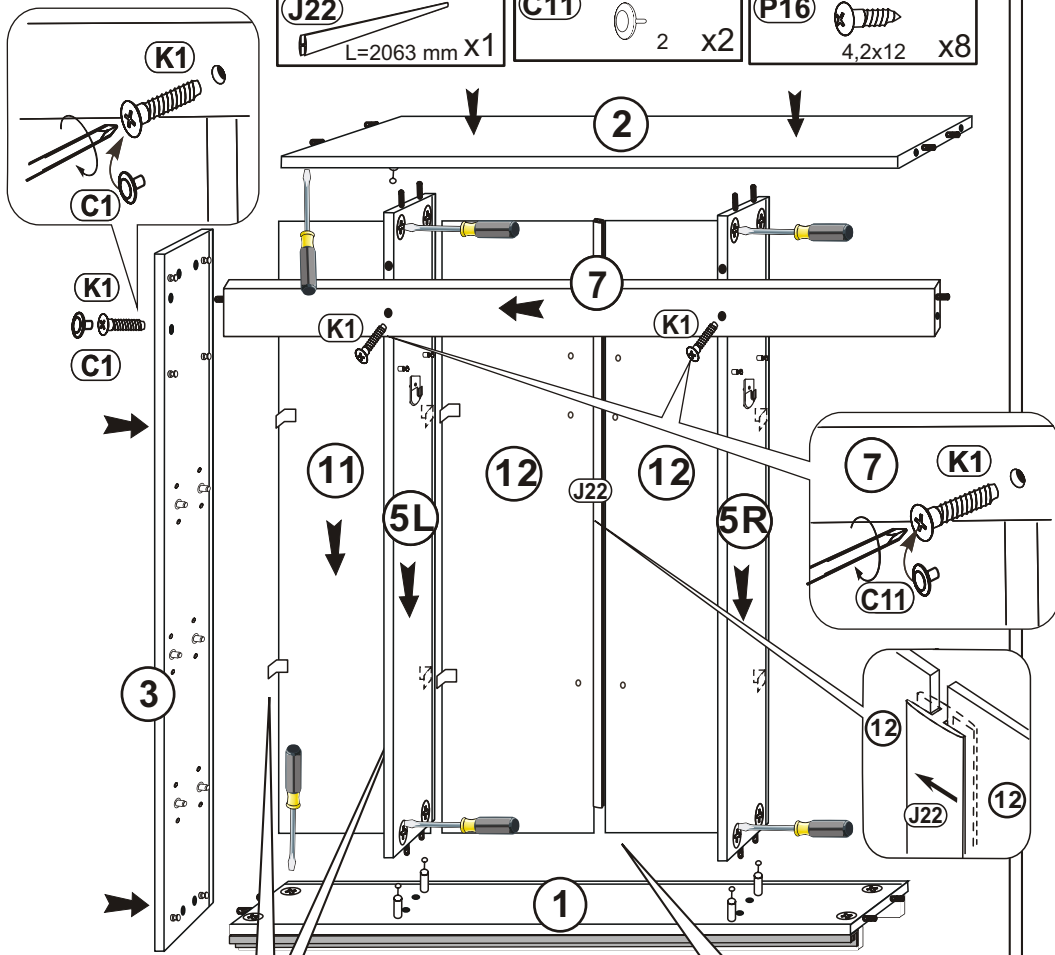

### 3

<b>K1</b>  x3	<b>C1</b>  2 x1	<b>M6</b>  x8
<b>J22</b>  L=2063 mm X1	<b>C11</b>  2 x2	<b>P16</b>  x8



### 4

<b>K1</b>  x1	<b>P16</b>  x4
<b>C1</b>  2 x1	<b>M6</b>  x4

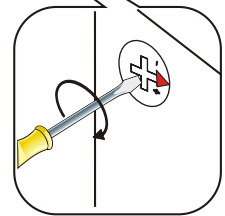
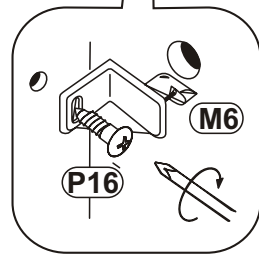
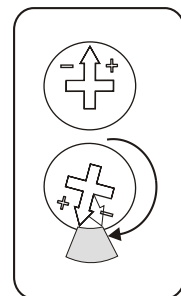
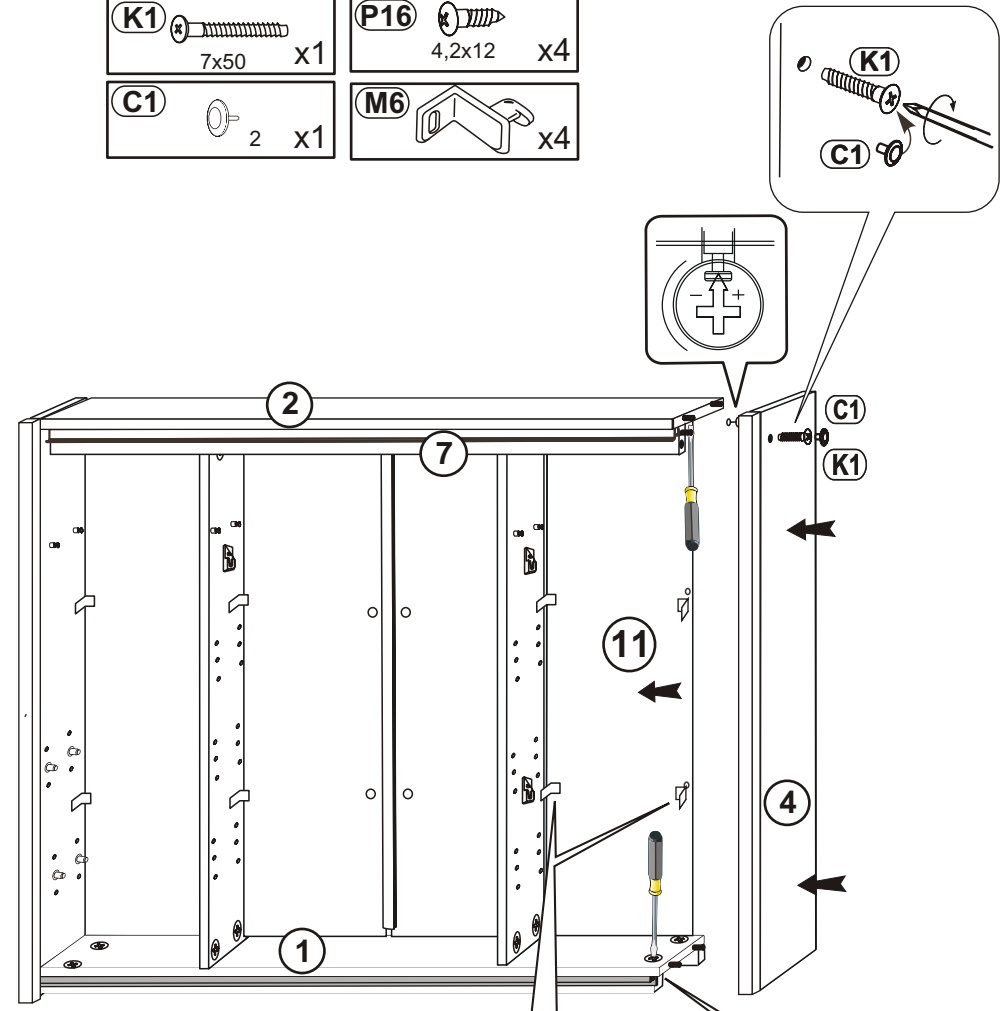

## 5

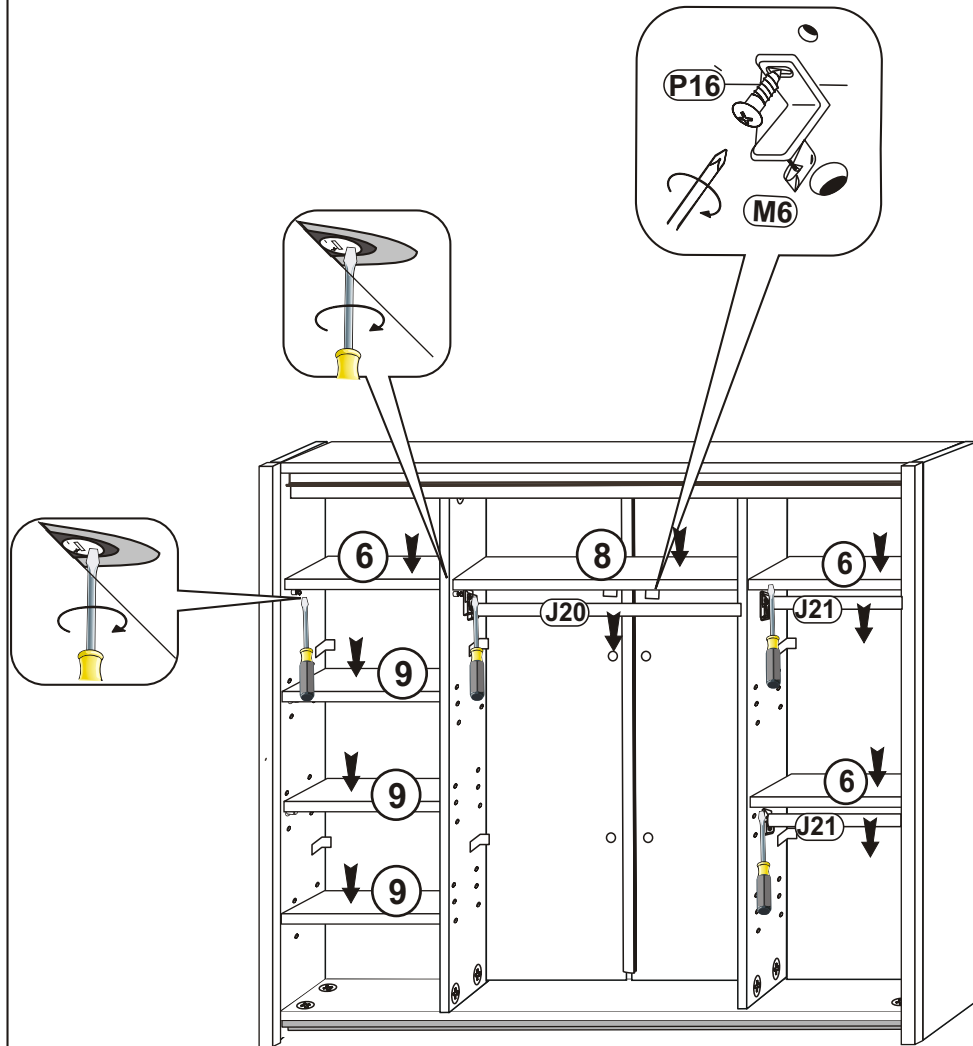
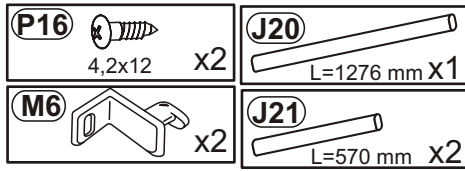

## 6

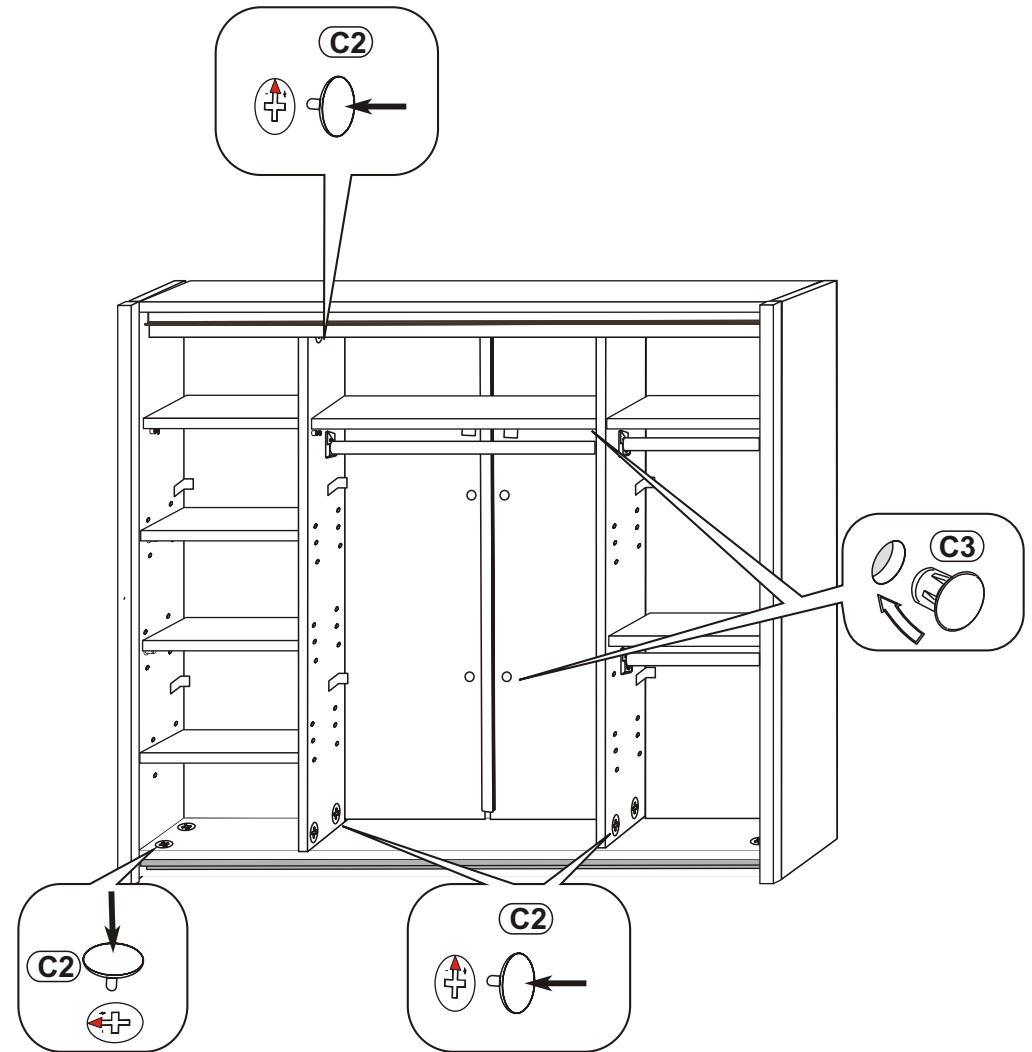
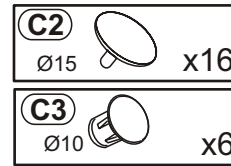

## 7

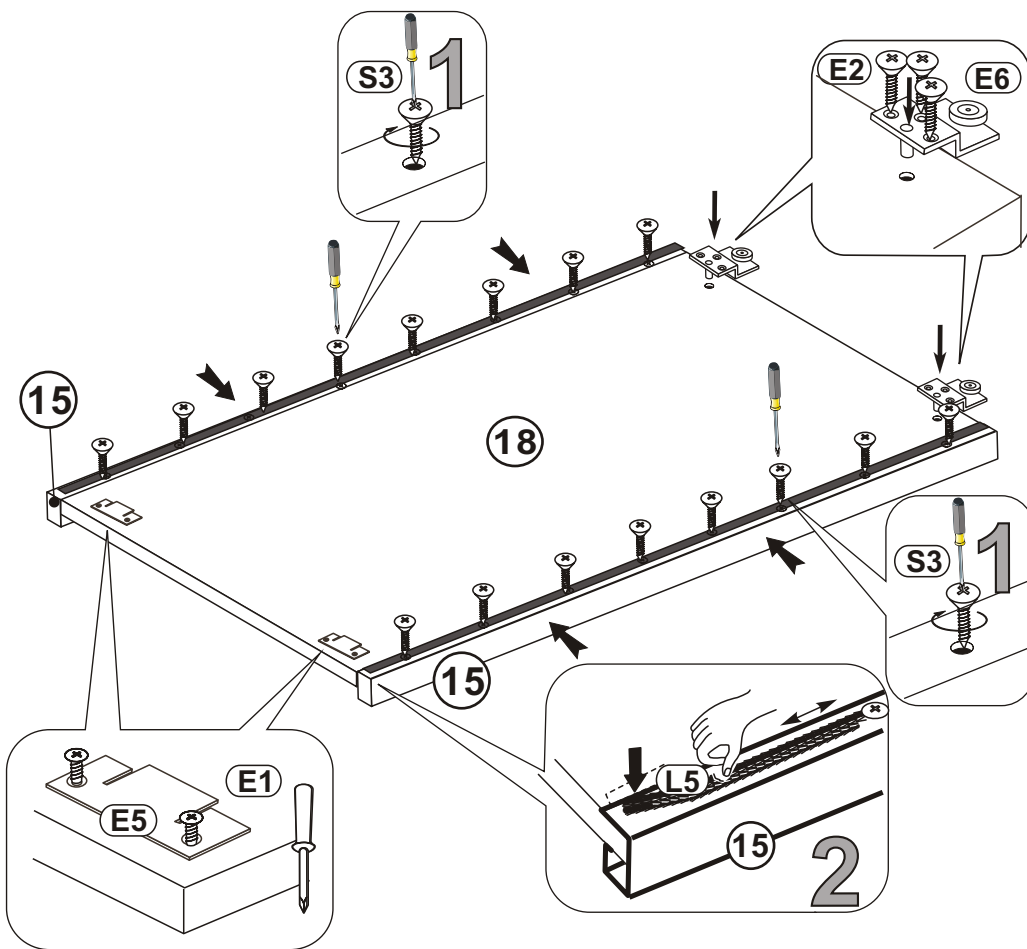
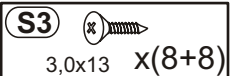
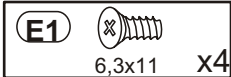
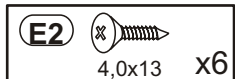
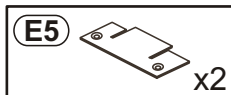
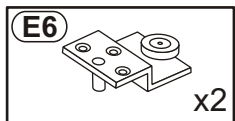

## 8

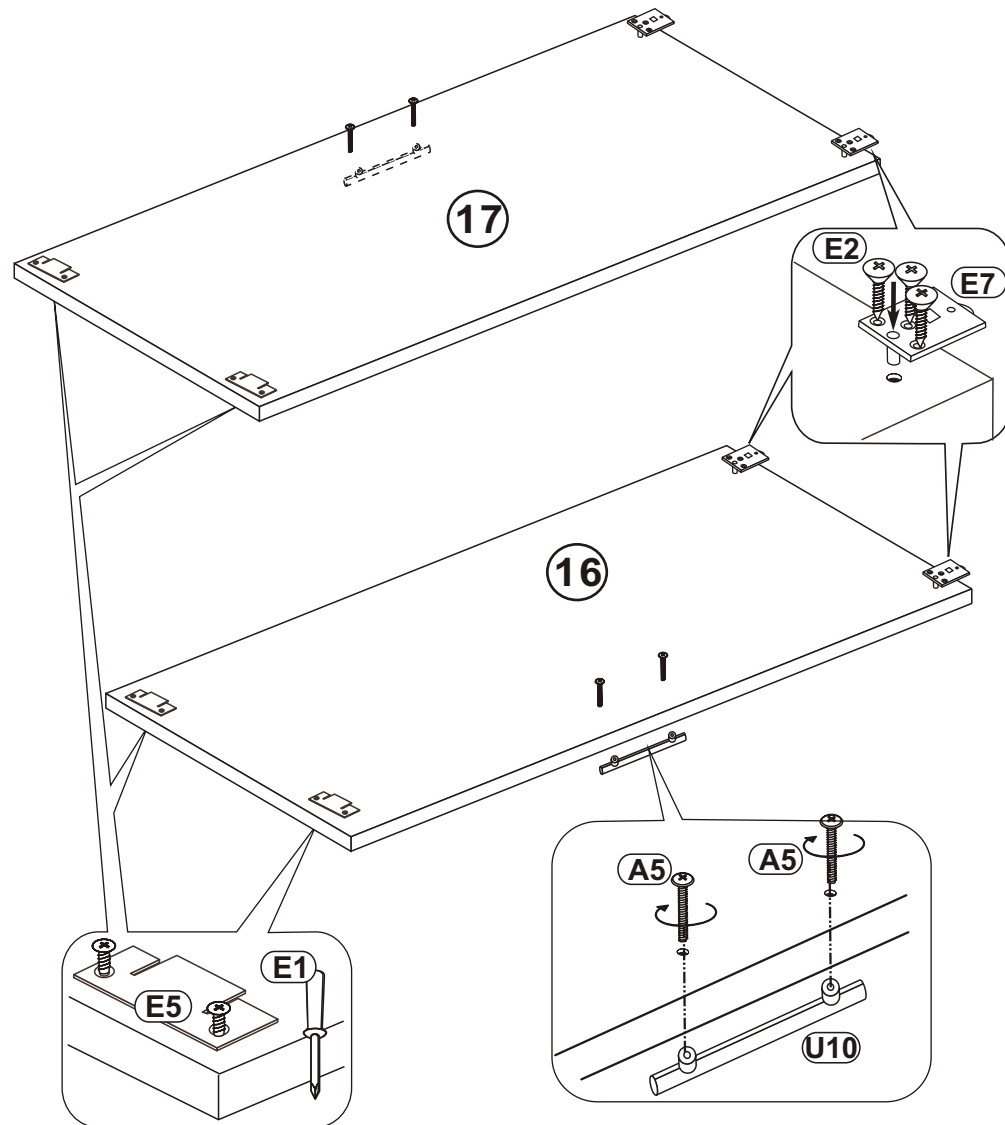
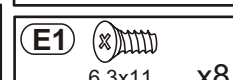
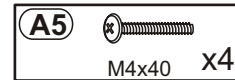
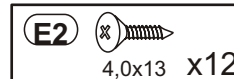
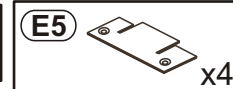
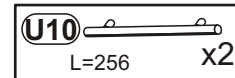
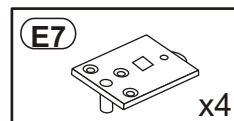

9

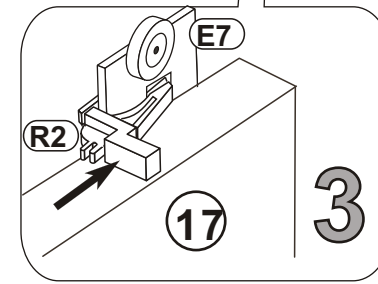
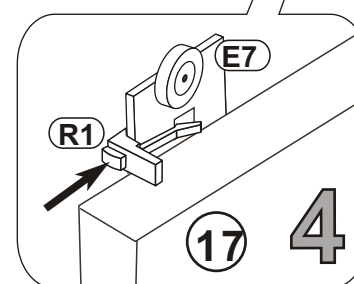
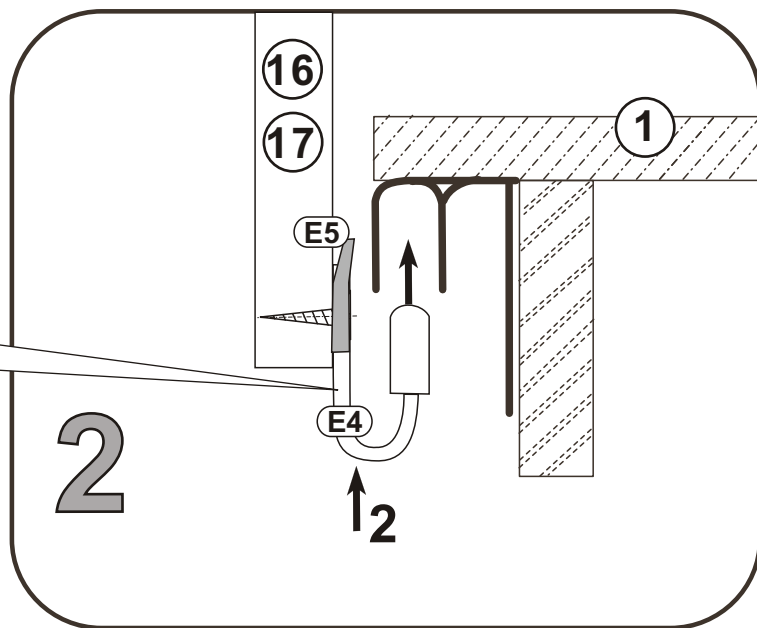
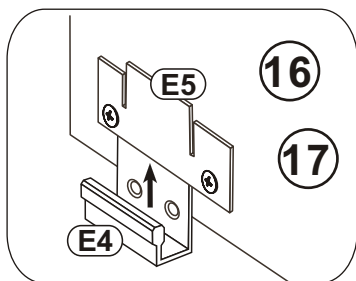
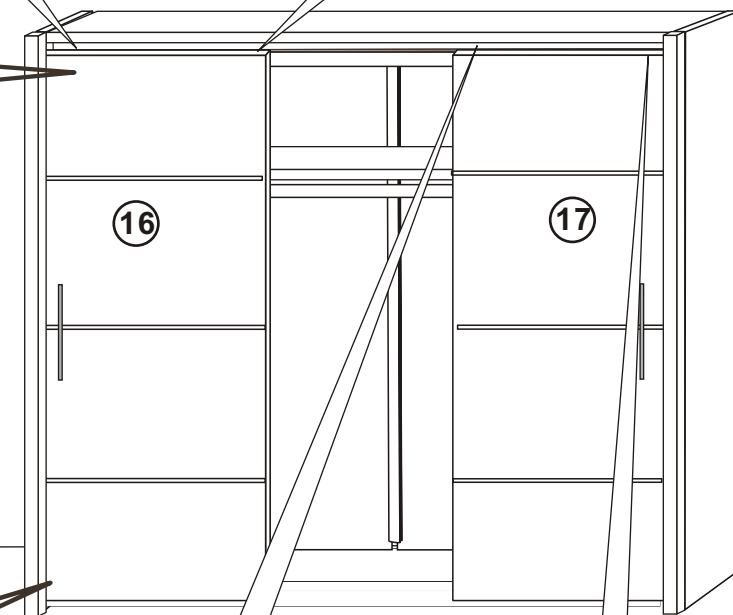
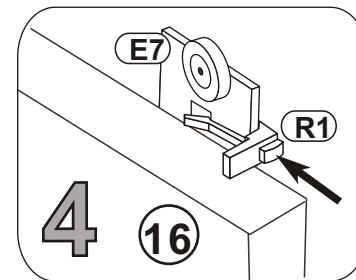
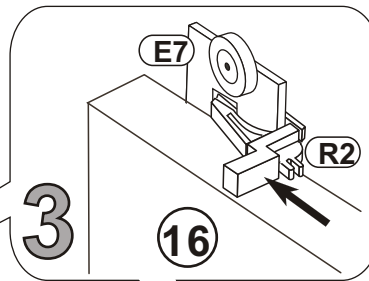
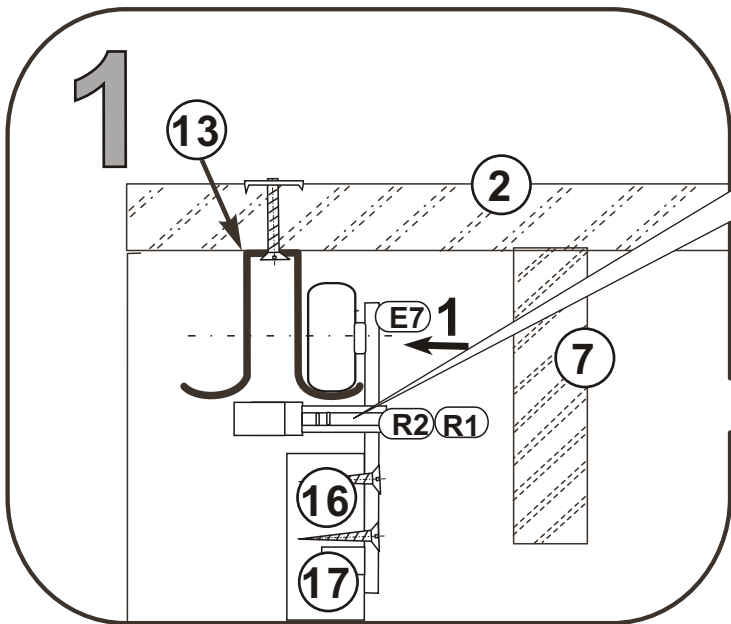
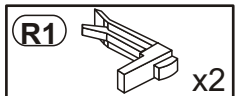
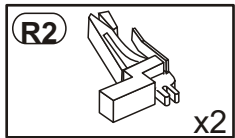
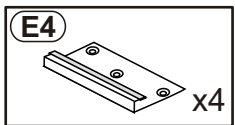



10

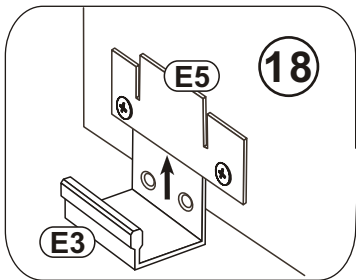
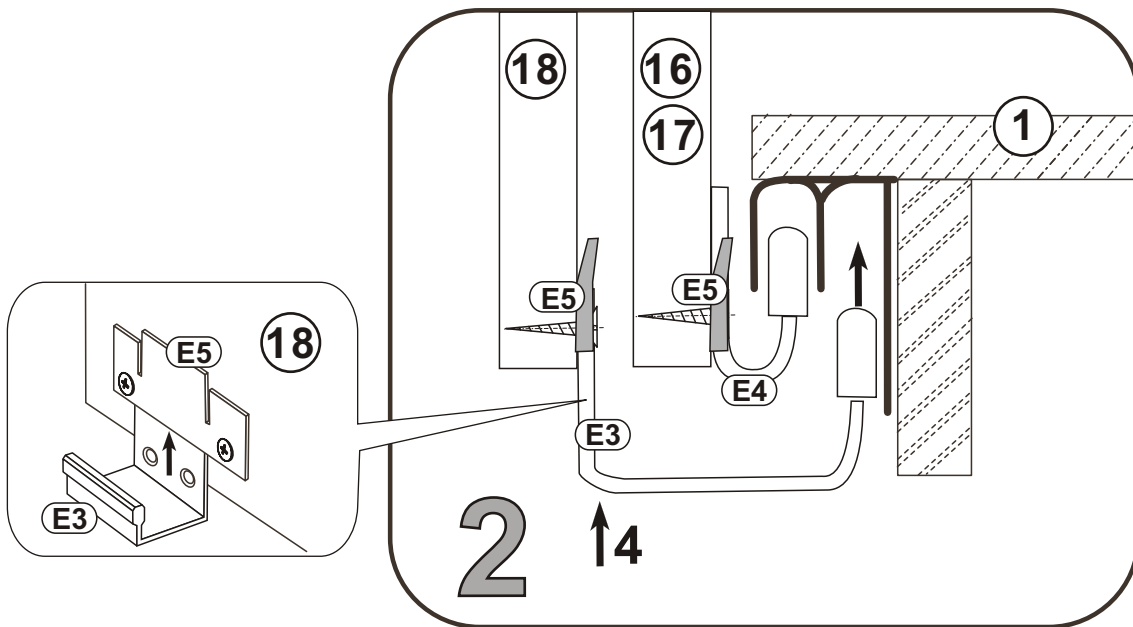
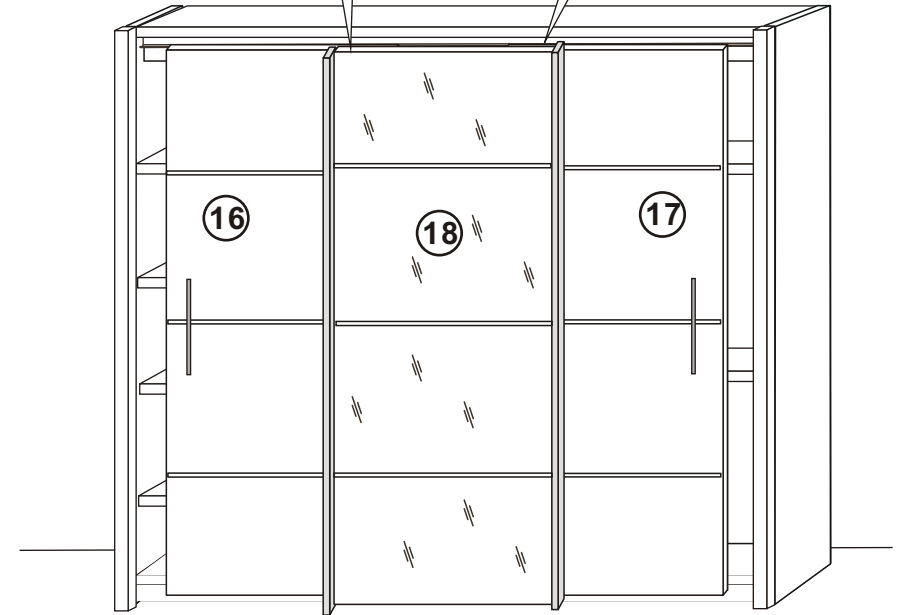
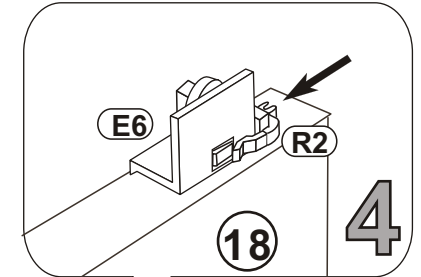
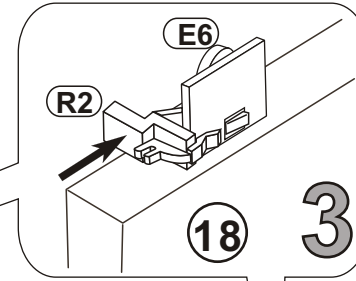
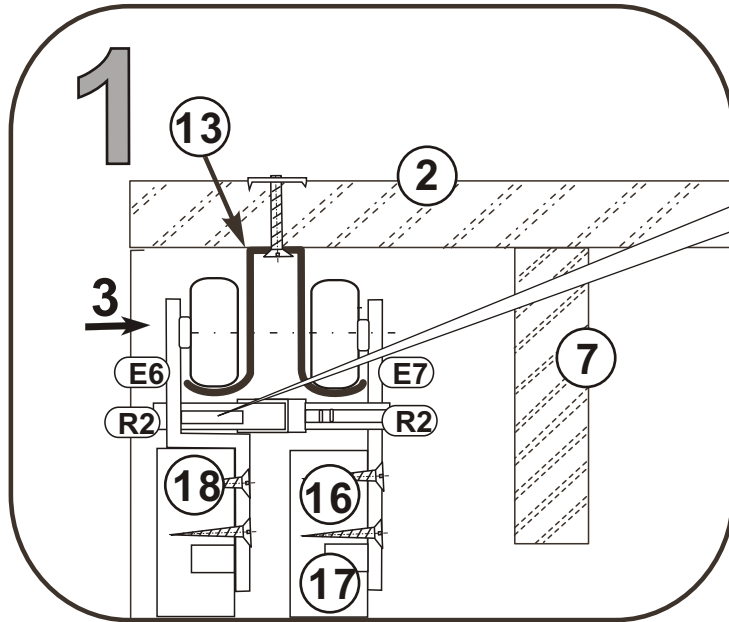
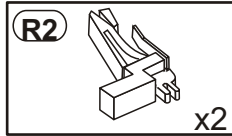
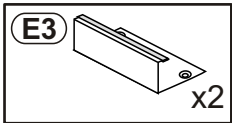

11

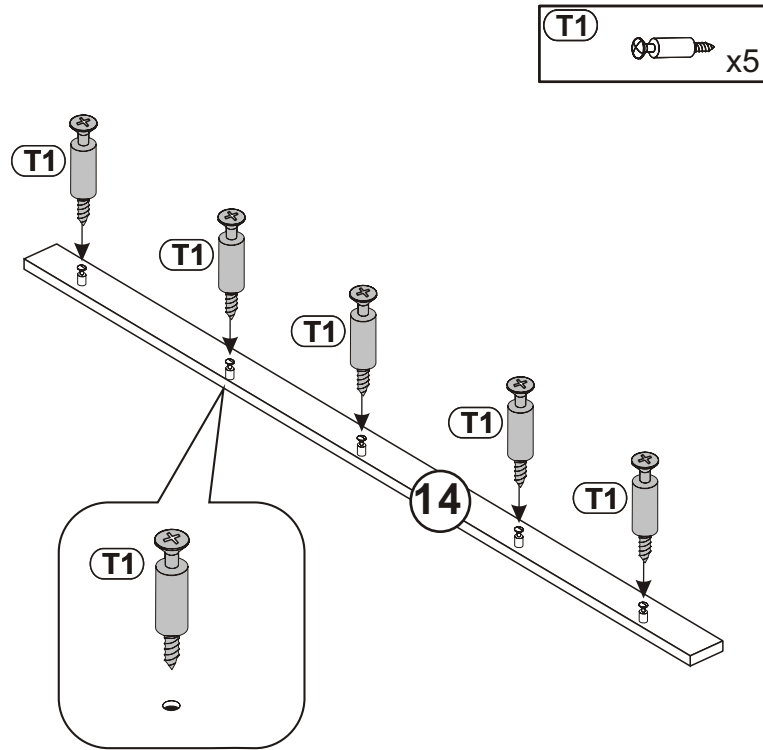

12

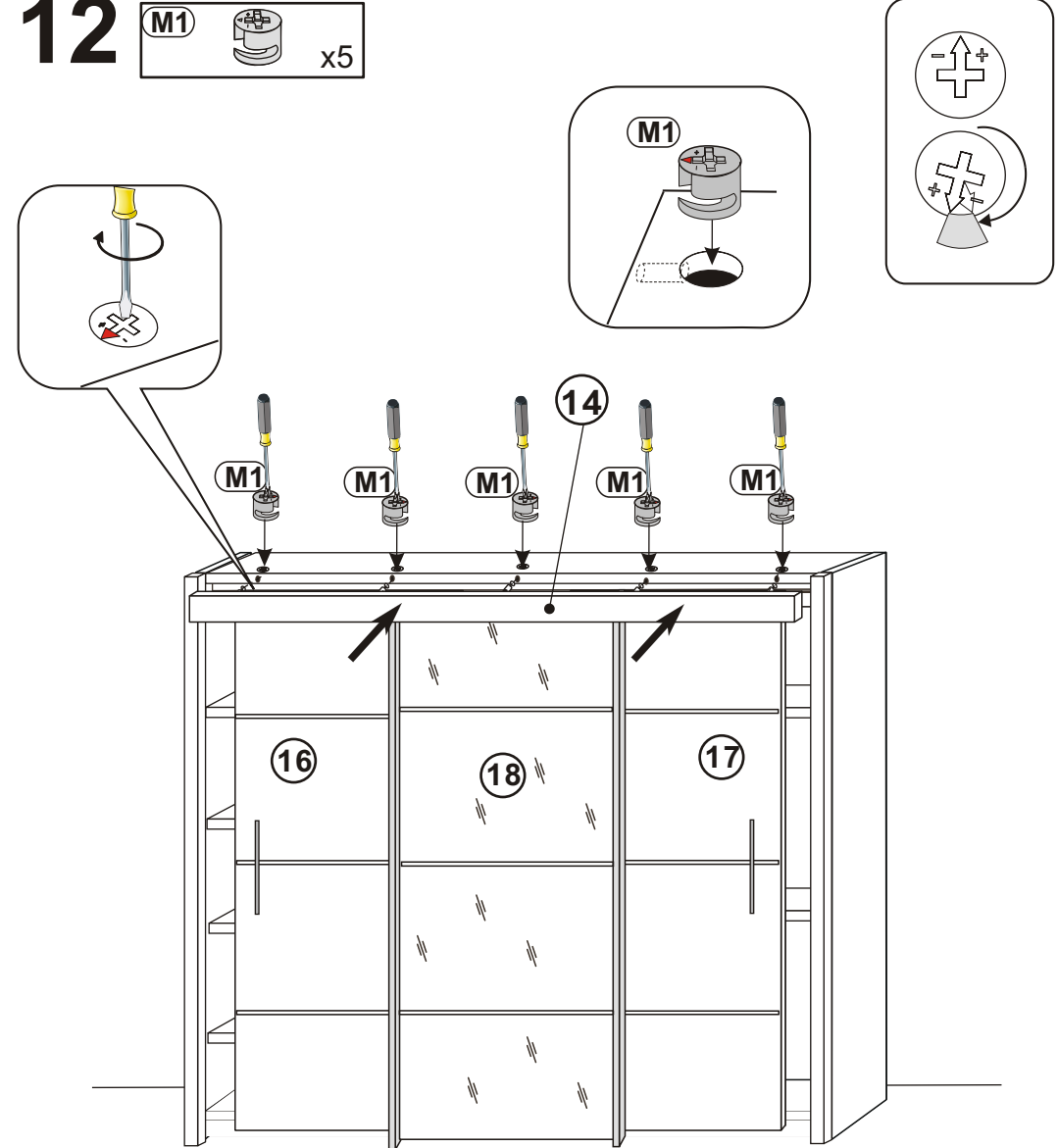

13

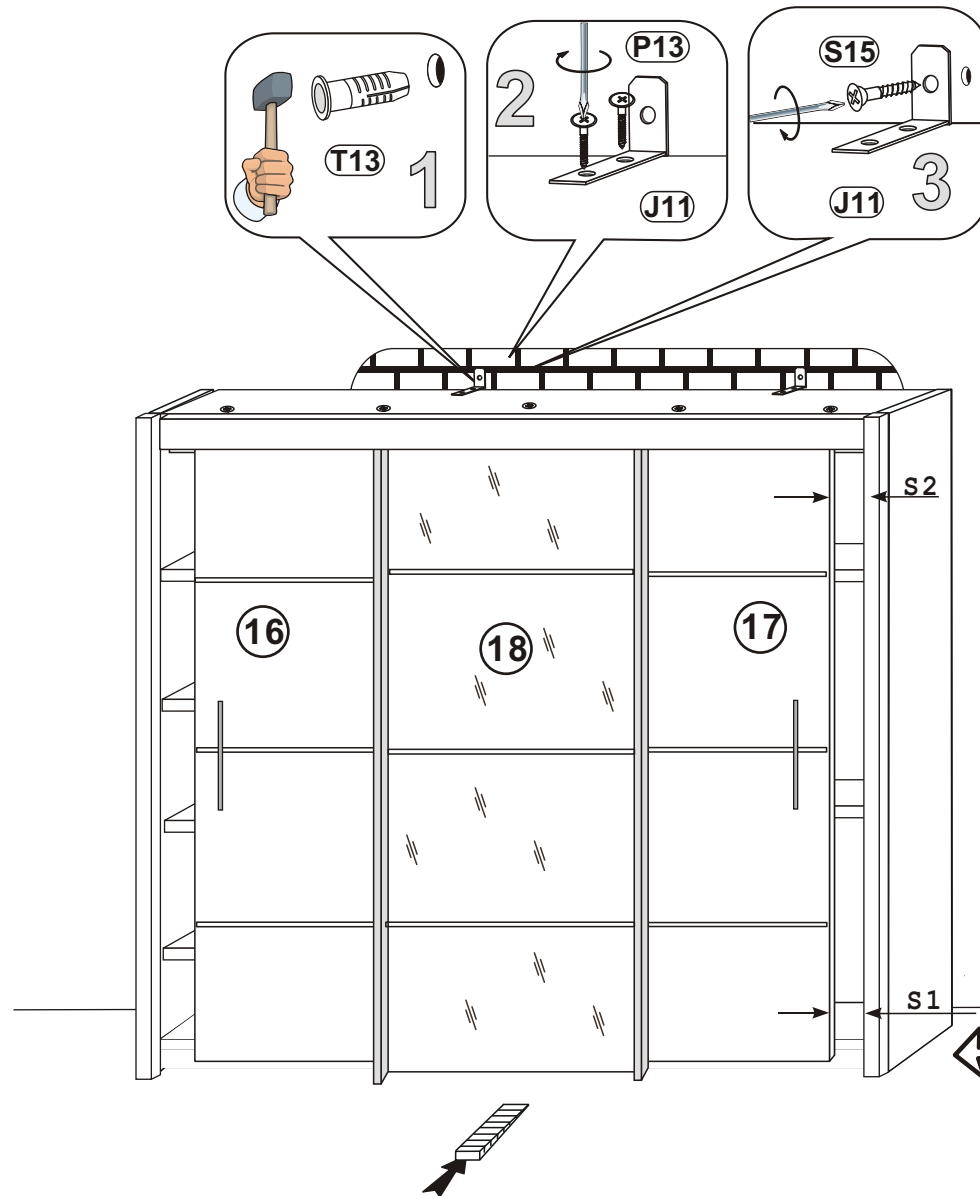

- (PL)** Załączone kołki do zawieszania bryty, do stosowania wyłącznie do ścian betonowych, do innych ścian należy odpowiednie dokupić.
- (GB)** Attached dowels to hang up unit are for concrete walls only. For other types of walls, appropriate dowels must be purchased
- (D)** Die beigelegten Dübel zum Aufhängen des Elements dürfen nur bei Betonwänden eingesetzt werden, bei anderen Wandarten müssen entsprechende Dübel zugekauft werden.
- (F)** Les chevilles jointes, pour pendre l'élément, sont pour les murs bétonnés exclusivement; pour autres murs il faut acheter chevilles adéquates

