

# Acrylic Sinks

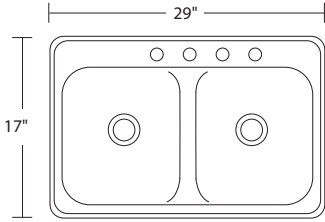

**KSxxA, KSxxAB**  
29" x 17"

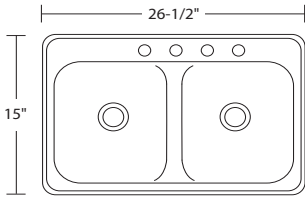

**KSxxB**  
26.5" x 15"

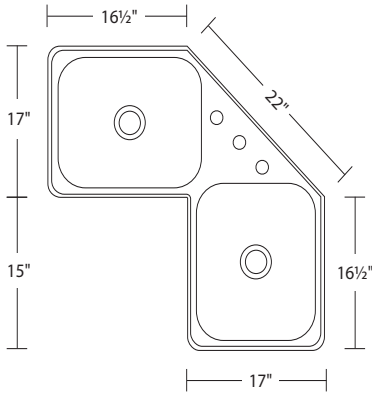

**KSxxV**  
32 1/4" x 32 1/4"

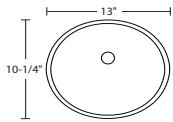

**KSENVxx**  
13" x 10.25"

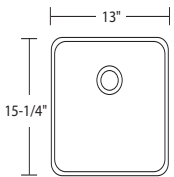

**KSxxH**  
13" x 15.25"

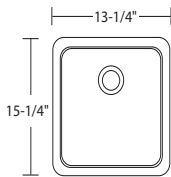

**KSxxHA**  
13.25" x 15.25"

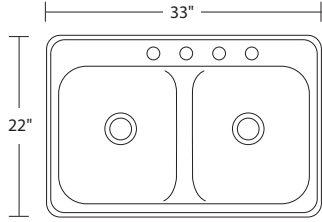

**KSxxDX, KSxxGC, KSxxHL, KSxxID, KSxxIN, KSxxLD, KSxxP, KSxxTE, KSxxVE, KSxxY**  
33" x 22"

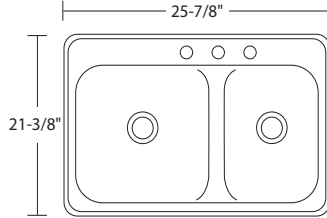

**KSxxK**  
25.875" x 21.375"

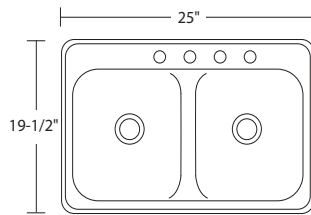

**KSxxE, KSxxEE**  
25" x 19.5"

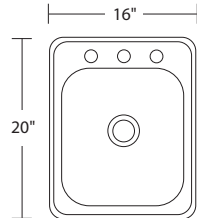

**KPREPxx**  
16" x 20"

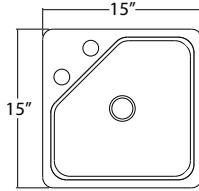

**KSxxSQ2**  
15" x 15"

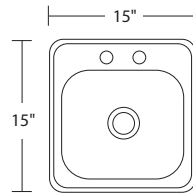

**BARxx**  
15" x 15" x 6.5"

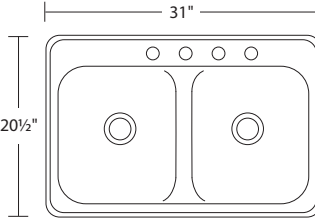

**KSxxLX, KSxxZ**  
31" x 20.5"

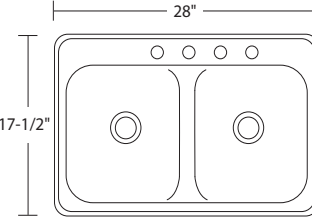

**KSxxN, KSxxS**  
28" x 17.5"

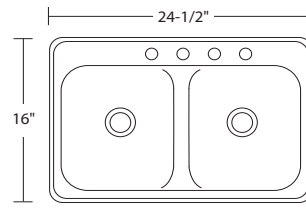

**KSxxMD, KSxxM**  
24.5" x 16"

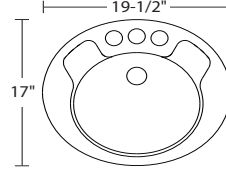

**LAVxx19**  
19.5" x 17"

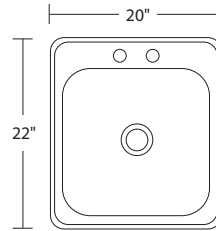

**LTxx**  
20" x 22"

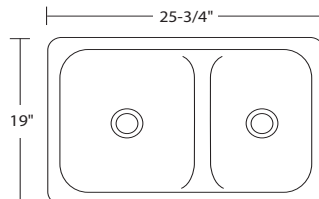

**KSxxKB**  
25.75" x 19"

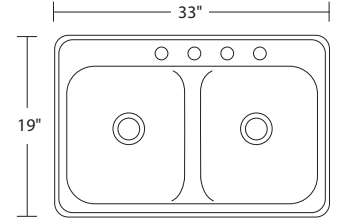

**KSxxC, KSxxCB, KSxxJ, KSxxQ, KSxxR, KSxxSB3**  
33" x 19"

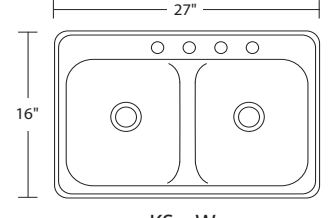

**KSxxW**  
27" x 16"

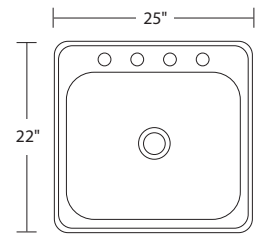

**KSxxX**  
25" x 22"

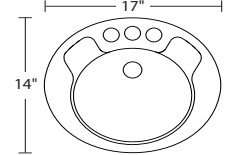

**LAVxx17**  
17" x 14"

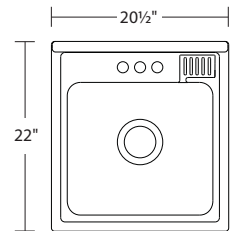

**LTBxx**  
20.5" x 22"

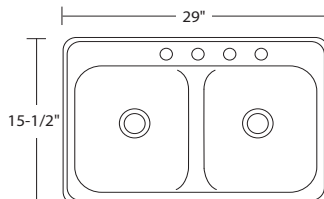

**KSxxxA**  
29" x 15.5"

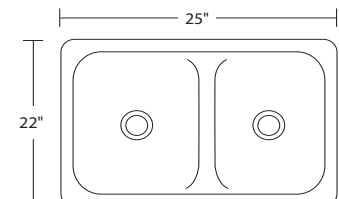

**KSxxCS**  
25" x 22"

## DO YOU HAVE?

Tape measure  
Pencil  
Safety glasses  
Caulk gun  
Caulk (color matched or clear)  
Saber saw or keyhole saw

## IMPORTANT

- + Before you begin, determine appropriate product reference (above).
- + Read installation instructions carefully before starting project.
- + Keep instructions for warranty information.
- + Do not use plumber's putty. May result in product failure. Use a high grade silicone caulk or latex for all necessary locations.

# INSTALLATION INSTRUCTIONS

## REPLACING YOUR OLD SINK:

No cutting of your existing countertop is necessary. Simply place the sink in the hole and make sure the rim of your new sink rests on your countertop. If you need to adjust the hole size, use a saber saw or keyhole saw then continue with the instructions below.

## MOUNTING SINK IN A NEW COUNTERTOP:

- + Place the sink upside down on the countertop in the desired location.
- + With a pencil, trace a line around the outside edge of the sink onto the countertop.
- + Remove sink from the countertop.
- + Measure in 7/8" and draw new lines inside the first sink outline just drawn. Radius corners are not required. As a reference please see cut out dimensions on next page for your product.
- + Cut out the countertop on this new line.
- + Trial fit your sink into the hole, making sure it is centered where you want it.
- + Remove sink. Use a good grade of silicone caulk/adhesive and apply a bead under the lip of the sink, then replace the sink in the hole.
- + Attach sink to countertop with bolts and clips provided-see below. Hand tighten bolts only with three rotations. (Fig. 1)

**IMPORTANT — Do not over tighten bolts. Sink will damage if bolts are over-tightened.**

\*Note: It's not necessary for the bolts and clips to be installed. Their primary purpose is to hold the sink in place while the adhesive dries. If there isn't clearance for them, follow steps 1-7 and fill sink with water to hold in place while adhesive dries.

- + To finish the job, fill any variances between counter top and sink by sealing outside of sink with a good grade of color-matched or clear silicone caulk/adhesive.
- + When installing drain to sink make sure to use a high grade silicone caulk or latex.  
**Do not use plumber's putty.**

## CARE AND CLEANING INSTRUCTIONS

- + Clean surface with nonabrasive liquid detergent and warm water. Use cleaning products such as Soft Scrub Gel®, Comet Gel®, Gel Gloss® or other similar products.
- + DONOT USE ABRASIVE CLEANERS, "steel wool" or wire brushes on surface. Caustic drain cleaners may cause surface damage. Open flames (cigarettes, candles, etc.) may damage surface.
- + Surface damage-light scratches, dulled areas, and small cuts and are restored by first scrubbing with automotive-type white body cleaning compound, such as Meguire's #9 Swirl® Remover, followed by an application of Gel Gloss®. See next page for detailed Scratch Repair Instructions.
- + Remember to always use a cutting board or sink protector when using knives or sharp objects in your sink.
- + Recommendation: When pouring boiling water or placing hot pots or pans into the sink, run some cold water simultaneously.

**WARNING: Some cleaning products are not suitable for use. Read all labels carefully. DO NOT USE if they say "not suitable for use with ABS, acrylic or polystyrene".**

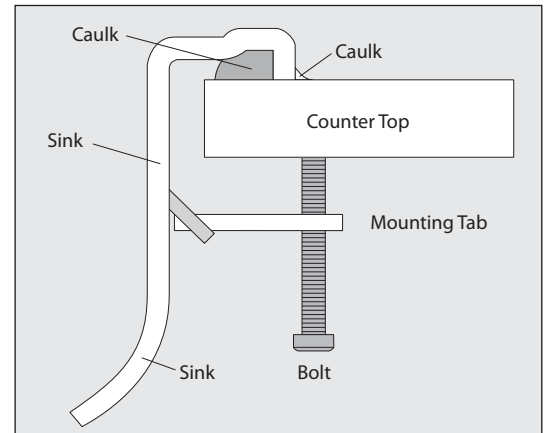
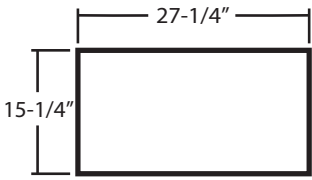

FIGURE 1. Attach sink to countertop as shown.

**Lyons**<sup>®</sup>  
The finishing touch.

**LYONS INDUSTRIES, INC.**  
30000 M-62 West, Dowagiac, MI 49047  
phone (800) 458-9036 fax (269) 782-5159  
lyonsindustries.com  
e-mail lyonsind@lyonsindustries.com  
4000-00153 8/15/11

# SINK TEMPLATE DIMENSIONS



KSxxA, KSxxAB

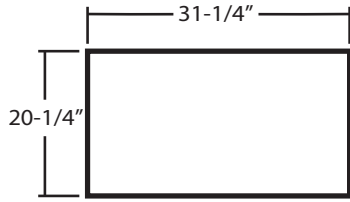

KSxxDX, KSxxGC, KSxxHL,  
KSxxID, KSxxIN, KSxxLD, KSxxP,  
KSxxTE, KSxxVE, KSxxY

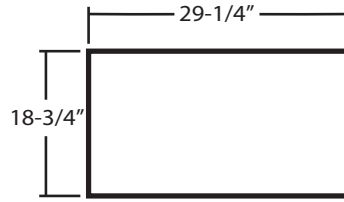

KSxxLX, KSxxZ

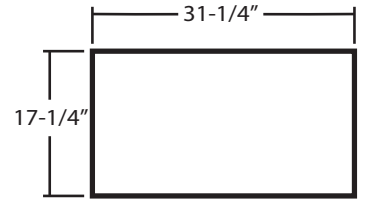

KSxxC, KSxxCB, KSxxJ,  
KSxxQ, KSxxR, KSxxSB3

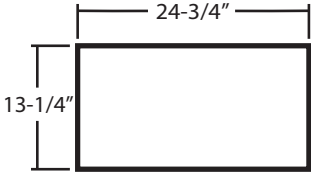

KSxxB

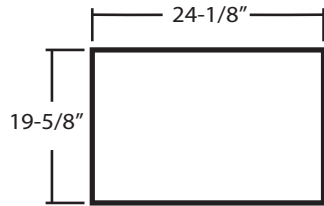

KSxxK

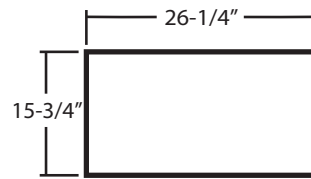

KSxxN, KSxxS

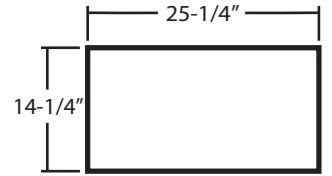

KSxxW

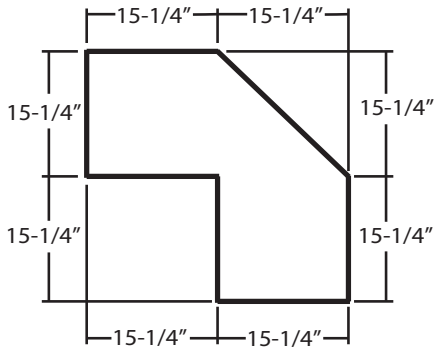

KSxxV

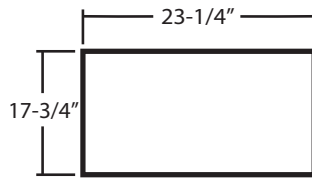

KSxxE, KSxxEE

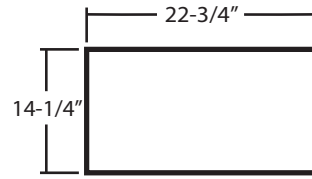

KSxxMD, KSxxM

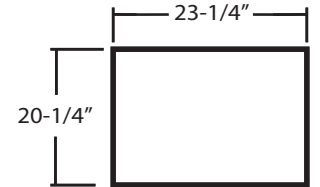

KSxxX

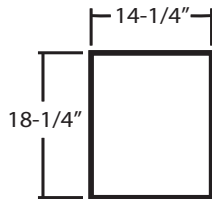

KPREPxx

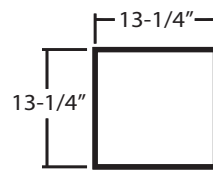

KSxxSQ2

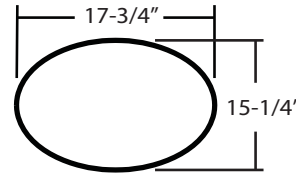

LAVxx19

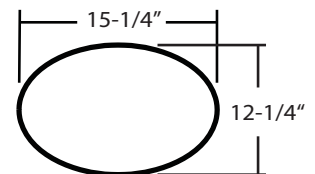

LAVxx17

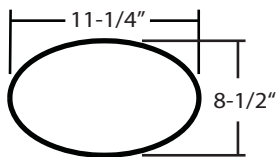

KSENVxx

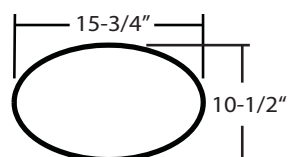

LAVxx15

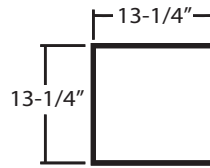

BARxx

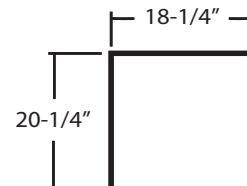

LTxx

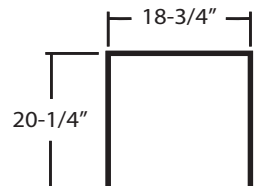

LTBxx

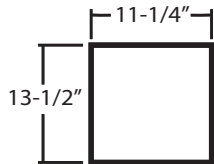

KSxxH

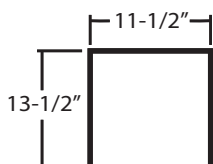

KSxxHA

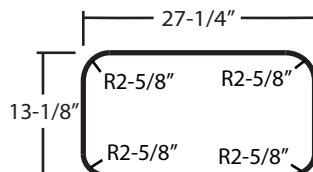

KSUxxA

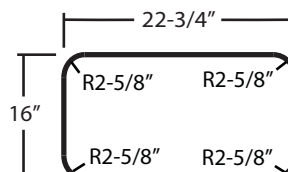

KSUxxKB

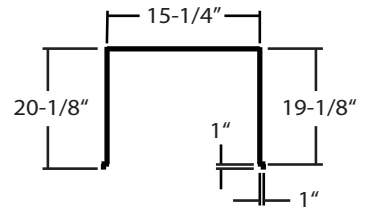

KSxxCS

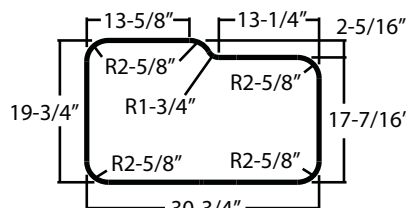

KSxxVE-Undermount

# WARRANTY INFORMATION

Please fill out and return to: LYONS INDUSTRIES, INC. 30000 M-62 WEST, Dowagiac, MI 49047

Name \_\_\_\_\_

Name of Store Purchased From \_\_\_\_\_

Street Address \_\_\_\_\_

Date of Purchase \_\_\_\_\_

City \_\_\_\_\_ State \_\_\_\_\_ Zip \_\_\_\_\_

Location of Store: City \_\_\_\_\_ State \_\_\_\_\_

Phone \_\_\_\_\_

Signature \_\_\_\_\_

Date \_\_\_\_\_

## SCRATCH REMOVAL INSTRUCTIONS

1. For effective scratch removal and polishing, you will need to purchase these items.

1 sheet 1000 grit 3M® wet-dry sandpaper

1 sheet 1500 grit 3M® wet-dry sandpaper

1 sheet 2000 grit 3M® wet-dry sandpaper

1 small container of 3M® rubbing compound #05933

These items can be purchased at most auto supply stores that provide supplies to professional paint and body shops. Call before you go.

Not all auto supply stores will have these items.

2. Start sanding with 2000 grit paper. Use small squares of paper about 2" x 2" for all sanding and use lots of water. The water serves as both a lubricant and to prevent residue buildup on the paper. Residue buildup shortens the effective life of the paper and may scratch the surface you're trying to polish.

3. 2000 grit paper is the finest grit available (the higher the number, the finer the grit). If you can't remove all of the scratches with 2000 grit, switch to 1500 grit. Remember to wash the paper frequently with water as you sand.

4. If all of the scratches can't be removed with 1500 grit, switch to 1000 grit. This should remove most fine scratches. If you have deep scratches or a gouge, coarser paper may have to be used (see chart to right). Be careful! Using grit that is too coarse may actually put in more scratches than it removes.

5. Once you have removed all of the scratches, by sanding with the finest paper possible, repeat the sanding process using successively finer grits of paper until you've once again sanded with 2000 grit.

6. Now use 3M® rubbing compound #05933 on a soft, damp cloth. Polish using considerable pressure to produce a smooth, shiny finish.

SUPERFICIAL SCRATCH  
2000 grit

LIGHT SCRATCH  
1500 – 2000 grit

MEDIUM SCRATCH  
1000 – 2000 grit

DEEP GOUGE  
600 – 2000 grit

## SCRATCH / SANDPAPER GUIDE

### LYONS PREMIUM CAST ACRYLIC KITCHEN SINK — LIFETIME LIMITED WARRANTY

Lyons Industries, Inc warrants to the original purchaser that this Kitchen Sink will be free of manufacturing defects, which affect the performance of this product for the use it was intended. The warranty period begins when the consumer/user purchases the unit.

#### FROM DATE OF PURCHASE

**1<sup>st</sup> Year** - Should the unit be otherwise than warranted, Lyons Industries, Inc will repair or exchange a defective unit. The exchange of a unit will be limited to supplying a replacement unit or component part of comparable size and style, and does not include any cost of removal, installation or transportation.

**2<sup>nd</sup> Year** - Should the unit be otherwise than warranted, Lyons Industries, Inc will pay 50% of the sink value toward repair or exchange of a defective unit. The exchange of a unit will be limited to supplying a replacement unit or component part of comparable size and style, and does not include any cost of removal, installation or transportation.

**3<sup>rd</sup> Year** - Should the unit be otherwise than warranted, Lyons Industries, Inc will pay 25% of the sink value toward repair or exchange of a defective unit. The exchange of a unit will be limited to supplying a replacement unit or component part of comparable size and style, and does not include any cost of removal, installation or transportation.

**4 or More Years** - Should the unit be otherwise than warranted, Lyons Industries, Inc will pay 10% of the sink value toward repair or exchange of a defective unit. The exchange of a unit will be limited to supplying a replacement unit or component part of comparable size and style, and does not include any cost of removal, installation or transportation.

Lyons Industries, Inc reserves the right to require the return, at the purchaser's expense, of the damaged product for repair or exchange before providing the services under this warranty.

Warranty does not cover damage that can be repaired by following the Scratch Removal Instructions or the Care and Cleaning Instructions. This warranty excludes normal wear and tear. This warranty shall be voided by improper maintenance contrary to use and care Instructions.

This warranty does not apply to units installed in commercial or business establishments, hotels, or apartments. Nor does the warranty apply if the unit is moved from its place of initial installation, subject to accident, abuse or misuse. No warranty will apply if the unit is not installed in accordance with the instructions supplied by Lyons Industries, Inc, local building codes and ordinances or if the care and cleaning instructions have not been followed.

Any implied warranty of fitness for a particular use or purpose, or warranty of merchantability is limited in duration to the express warranty provided herein unless a shorter period is allowed by law. Lyons Industries, Inc shall not be liable for incidental or consequential damages for any damage to building, its contents or occupants. Some states do not allow limitations of incidental or consequential damages so the above limitations and exclusions may not apply to you. In such a state, liability shall be limited to the extent permitted by state law.

Any claim under this warranty must be made in writing, with your original proof of purchase enclosed to Lyons Industries, Inc, 30000 M-62 West, Dowagiac, Michigan 49047 to request performance by Lyons Industries, Inc under the terms of this warranty. After such notice, a prompt investigation of the claim shall be made by Lyons Industries, Inc who will promptly perform its obligation under the terms of this warranty.

FOR ASSISTANCE CALL (800) 458-9036