

Operating Instructions

QLEENO™



Model QS101

WARNING

The owner and/or operator shall have an understanding of the product, its operating characteristics and safety instructions before operation. For your safety, read, understand, and follow the information provided with and on this product before using. If the operator is not fluent in English, the product and safety instructions shall be read to the operator in their native language.



This is the safety alert symbol. It is used to alert you to potential personal injury hazards. Obey all safety messages that follow this symbol to avoid possible injury or death.

Protect your investment! Register your Qleeno at www.qleenousa.com

SFA Companies, Inc.
10939 N. Pomona Ave. Kansas City, MO 64153
customerservices@shinnfuamerica.com



Read this manual and follow all the Safety Rules and Operating Instructions before using the product.

qleeno rev 102011

TABLE OF CONTENTS

| | |
|--|----|
| Warnings | 2 |
| Safety and General Information | 4 |
| Product Description and Specifications | 4 |
| Preparation | 5 |
| Operation | 7 |
| Troubleshooting and Maintenance | 8 |
| Replacement Parts | 11 |
| Warranty | 12 |

SIGNAL WORDS

| | |
|---|--|
|  DANGER Indicates situation which, if not avoided, will result in death or serious injury |  WARNING Indicates situation which, if not avoided, could result in death or serious injury |
|  CAUTION Indicates situation which, if not avoided, could result in minor or moderate injury | NOTICE Indicates situation which, if not avoided, could result in damage to property |

WARNING

- Read, understand and follow all instructions provided with/on this machine.
- Inspect the device before each use to make sure there are no defects or damage. The machine shall not be used if it has been damaged, isn't working properly, has been subjected to wet conditions or has been left outdoors.
- This machine requires an extension cord. Do not run over the extension cord. Do not use the machine if the electrical cord shows signs of damage. Inspect the cord carefully if it becomes twisted, bent, crushed or is run over. If damage is observed, replace the cord before using Qleeno.
- Do not use Qleeno to remove explosive or flammable materials. It should not be used in a flammable or explosive environment.
- Do not modify this device mechanically or electrically. Do not attempt to alter or defeat safety devices in any way.
- Never insert hands, feet or other foreign objects into or close to the brush mechanism while Qleeno is in operation. Always make sure the machine is disconnected when inspecting the rotating brush mechanism.
- Qleeno should only be used by properly trained operators.
- Ensure wheel height is properly adjusted and machine does not pull in any direction.

| | |
|------------------|------------------------|
| Serial No. _____ | Date of Purchase _____ |
|------------------|------------------------|

WARNING

- If using detergents with Qleeno, follow all instructions from the manufacturer. Use only non-foaming detergents.
- As much as practical, operate Qleeno on a surface clear of obstructions and other people. Use in well-lit areas.
- Qleeno is only suitable for use on flat surfaces, and is not for use on stairs.
- The operator should always remain behind the machine while in use.
- Do not release the handle while Qleeno is running. Always maintain positive control of the machine. Always turn off the machine when not in use.
- Keep children away from this equipment. Qleeno is not a toy and may be dangerous in the hands of an untrained user.
- Never leave the machine unattended while the electrical cord is connected to a power source.
- Exercise caution when operating Qleeno around tables and shelves where there is a risk of falling objects.
- Always turn Qleeno completely off and disconnect it from the power source when not in use or before storing, making adjustments, changing brushes, performing any type of cleaning, maintenance, or repair work.
- Disconnect electrical power by pulling on the plug, not the cord.
- When performing maintenance specified in this manual, follow all instructions. Use of unauthorized parts or failure to follow maintenance instructions may result in injury and damage to property.
- Maintenance or service other than prescribed in this manual must be performed by qualified repair personnel.

CAUTION

- Do not use or store Qleeno outdoors. Do not store in a wet or damp environment.
- Always turn off machine completely when not in use.
- Do not place, transport or store items on top of Qleeno. Do not use without the motor cover in place.
- It is recommended that an annual inspection be done by qualified personnel.
- Use only original, manufacturer approved replacement parts.

NOTICE

- Never use or store Qleeno in temperatures under 32° F/0° C. Liquid left in the reservoir may freeze. Empty reservoir completely if transporting Qleeno through environment with possible freezing conditions.
- Only use brushes and accessories recommended by the manufacturer. Use of non-approved equipment may adversely affect function and safety of the machine.
- Vacuum or sweep the surface of loose objects prior to using Qleeno. The Qleeno suction system is designed for water only.
- Do not use or store this device near strong magnetic fields (such as an MRI machine). Qleeno contains magnetic materials.
- Ensure that all brushes are properly installed prior to starting the machine.
- Floor coverings should be tested for suitability before using Qleeno. The manufacturer is not responsible for damage to the machine or flooring if Qleeno is used with improper brush, pad or detergent.

SAFETY AND GENERAL INFORMATION

Save these instructions. For your safety, read, understand, and follow the information provided with and on this product before using. The owner and operator of this equipment shall have an understanding of its safe operating procedures before attempting to use. The owner and operator shall be aware that use and repair of this product may require special skills and knowledge. Instructions and safety information shall be conveyed in the operator's native language before use of this equipment is authorized. If any doubt exists as to the safe and proper use of this product, remove from service immediately.

Inspect before each use. Do not use if broken, bent, cracked or damaged parts are noted. Any equipment that appears damaged in any way, or operates abnormally shall be removed from service immediately. It is recommended that an annual inspection be done by qualified personnel. Labels and Operator's Manuals are available from manufacturer.

PRODUCT DESCRIPTION

Qleeno is an electric powered, low-profile, wet floor scrubber. It scrubs and dries in one pass, and utilizes water and any common household floor cleaner. Qleeno is intended for commercial use only and is not a consumer product.

SPECIFICATIONS

| | |
|--------------------------|----------------------------|
| Working width | 15 in. (12" pad) |
| Operating time, per tank | 10 - 30 min. |
| Tank Volume | 0.8 gal. |
| Voltage | 230/115V 50/60Hz |
| Rated Power | 1500W |
| Size (W x L x H) | 16-1/2" x 38-7/8" x 7-1/2" |
| Weight (empty) | 66 lbs. |
| Brush Pressure | 26.5 lbs. |



PREPARATION

⚠ WARNING: Always turn Qleeno completely off and disconnect from power source when making adjustments, changing brushes, performing any type of cleaning, maintenance, or repair work.

⚠ CAUTION: Never use Qleeno without an extension cord, brush or pad holder with pad. Use only accessories and equipment supplied or recommended by the manufacturer.

Before Each Use

1. Inspect Qleeno to make sure no damage has occurred during transport, storage or previous use.
2. Inspect squeegee ring and change if edges or suction hoses show excessive wear.
3. Inspect brush or scouring pad - replace if necessary.
4. Ensure that correct brush/scouring pad is securely mounted to machine.
5. Adjust casters to proper height (ref. page 6).
6. Fill water tank with fresh water and chemical (if desired).

NOTICE: Follow chemical manufacturer's instructions when using cleaning agent. Use only non-foaming cleaning agents.

NOTICE: Qleeno is not intended to be used as a buffer. Do not fill water tank with wax.

NOTICE: After removing water tank, always carry with drain end down - water tank can spill if carried incorrectly. When replacing, set rear of tank on metal posts in frame side and insert tank ports in matching frame orifices.

NOTICE: Always empty dirty water before each use.



Carry water tank drain end down - water can leak through ports in front.

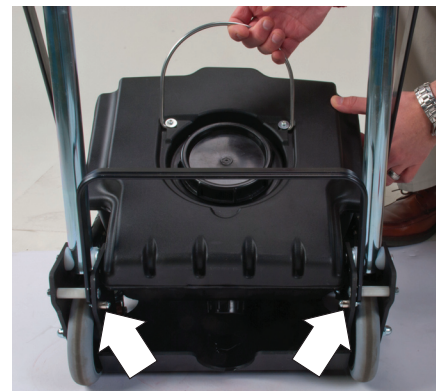

Place Water tank on metal posts at rear frame.

Mounting the brush/scouring pad

1. With Kick Stand folded up, lift Qleeno to upright (vertical) position and turn brush/scouring pad holder counter-clockwise to remove it.
2. Mount brush and turn clockwise until it contacts mounting tabs on hub (ref. photo below).
3. If using scouring pad, fasten the pad to the velcro on the pad holder, then mount in same way as brush.

NOTICE: For best results and longer pad life, ensure scouring pad is concentric with holder.



Unfolding the Handle

Unlock handle support locks on both sides of handle, raise handle to desired position and re-lock handle supports. Handle is adjustable to vertical position or intermediate positions to accommodate the user.



Adjusting the Casters

NOTICE: The Qleeno brush/pad should always operate as close to horizontal as possible, and should not cause the machine to drag or pull in any direction. Due to normal usage, the casters may require occasional adjustment.

1. Pull knob on adjustment arm (ref. photo) and raise/lower the caster to desired position.

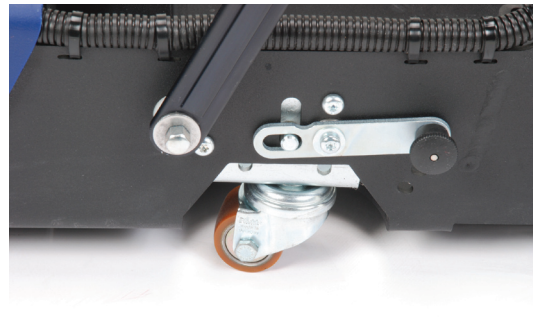
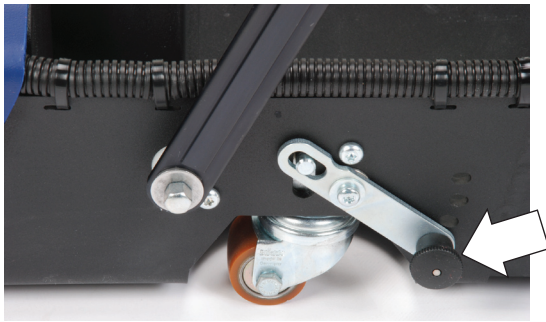

2. Knob will lock into one of four detents in side of machine.

OPERATION

Starting Qleeno

1. Qleeno requires the use of an extension cord. Handle should be upright and locked.
2. Mount brush or pad holder with scouring pad according to the instructions on previous page.
3. Connect to common household current (110V) electrical outlet via extension cord.
4. Tilt Qleeno backwards slightly before starting to avoid damaging the scrubber. Start Qleeno by pressing Start/ Stop Scrubber button on control pattern. The machine will perform a brief function test, after which the scrubber, water flow and suction will all commence.
5. Regulate water flow with Decrease Water Flow or Increase Water Flow buttons on control panel. Adjust water suction with button shown below.

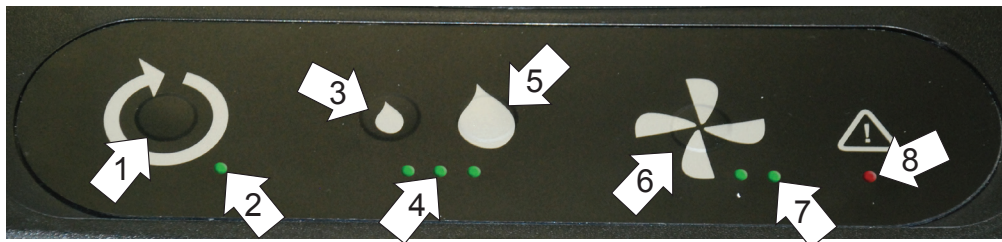

- | | | |
|-----------------------------|--------------------------------|----------------------------|
| 1. Start/Stop Scrubber | 3. Decrease Water Flow | 6. Start/Stop Suction |
| 2. Scrubber Indicator Light | 4. Water Flow Indicator Lights | 7. Suction Indicator Light |
| | 5. Increase Water Flow | 8. Warning Light (red) |

Normal Operation

Best results can be obtained by always using a full tank of clean water and chemical (if required). Move Qleeno in slow, overlapping lines over one portion of the surface at a time.

NOTICE: *Change direction slowly - do not move Qleeno in sudden or jerking motions.*

Judicious monitoring of water flow should provide the user with approximately 10 - 25 minutes of working time (low water flow setting - .03 gal/min; med water flow setting - .05 gal/min; high water flow setting - .10 gal/min).

Turning off Qleeno

1. Turn off water flow by pressing Decrease Water Flow button on control panel until all indicator lights go out. Continue cleaning for ten seconds to collect any excess water.
2. Turn Qleeno off by pressing Start/Stop Suction button on control panel. Suction will continue for an additional two seconds.
3. Disconnect power cord from power source.
4. Empty dirty water tank.

After Each Use

1. Clean the hub insert and inside of the hub.
2. Empty water tank. Position Qleeno over a floor drain and hold Decrease Water Flow button down for 3 seconds to empty clean water.
3. Clean brush/pad and squeegee ring.

Transporting Qleeno

⚠ CAUTION: Do not attempt lifting the entire machine without assistance. If transporting Qleeno a short distance, simply tilt the machine back on the transport wheels.

1. Unlock handle support locks, fold handle to lowest position and re-lock handle supports.
2. Lift front of machine and roll Qleeno with weight supported on transport wheels.



TROUBLESHOOTING

| Symptom | Corrective Action |
|--|--|
| Qleeno will not start | • Check electrical connection and fuse. |
| Control panel Warning Indicator Light is on | • Water tank is low. Empty dirty water and refill clean water. |
| Qleeno makes beeping sound and shuts off | • Water tank is empty. Empty dirty water and refill clean water. |
| Water will not flow after starting | • Check filters for clogging. |
| Qleeno leaks water | • Clean water tank seals. • Verify Water Fill cap is tight and properly threaded. • Check water pump on. • Inspect water tank for damage. |
| Qleeno leaks water when lifted for transport | • Check both caps on water tank firmly sealed. |
| Qleeno drags or pulls in one direction while operating | • Adjust casters (see pg. 5) |

MAINTENANCE

⚠ WARNING: Do not remove the motor cover. Maintenance requiring removal of the cover should only be performed by a qualified repair technician.

Changing the Fuse

Wait 15 minutes after shutting down before changing the fuse and attempting to restart the machine. The fuse is a standard 115V/10A, and is located under the control panel, near the electrical connection.

Cleaning the Hub

⚠ WARNING: Always turn Qleeno completely off and disconnect it from the power source when not in use or before storing, making adjustments, changing brushes, performing any type of cleaning, maintenance, or repair work.

NOTICE: The hub should be cleaned after each use to ensure optimum performance.

1. Turn hub insert clockwise to release bayonet lock.
2. Remove and clean hub insert. Clean inside of hub.
3. To reassemble hub, mate grooves on hub insert with screws around hub, seat insert fully and turn counterclockwise to lock in place.

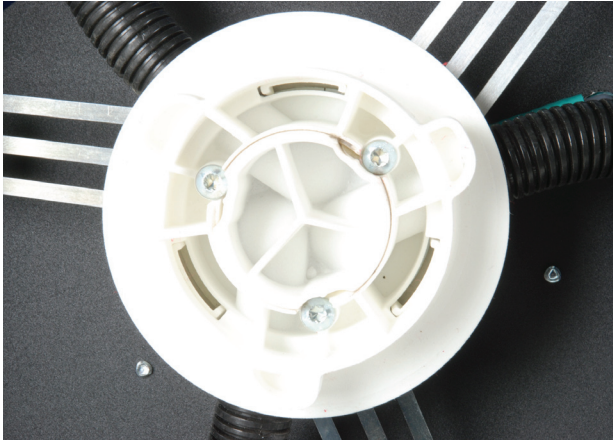

Changing the Squeegee Ring

1. Remove brush or pad holder.
2. Disconnect all three suction hoses from hub.
3. Lift squeegee ring just enough to allow access to nuts on mounting frame.
5. Using an 8mm wrench, remove nuts holding squeegee ring to mounting frame and replace with new ring.
6. To secure squeegee ring, follow steps 1 - 5 in reverse order.

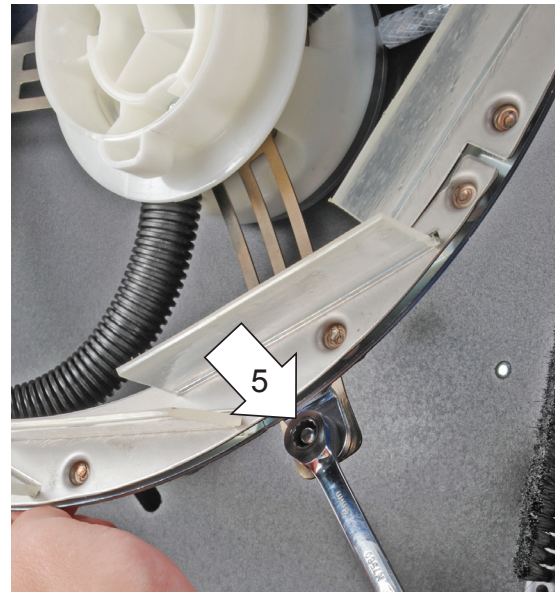
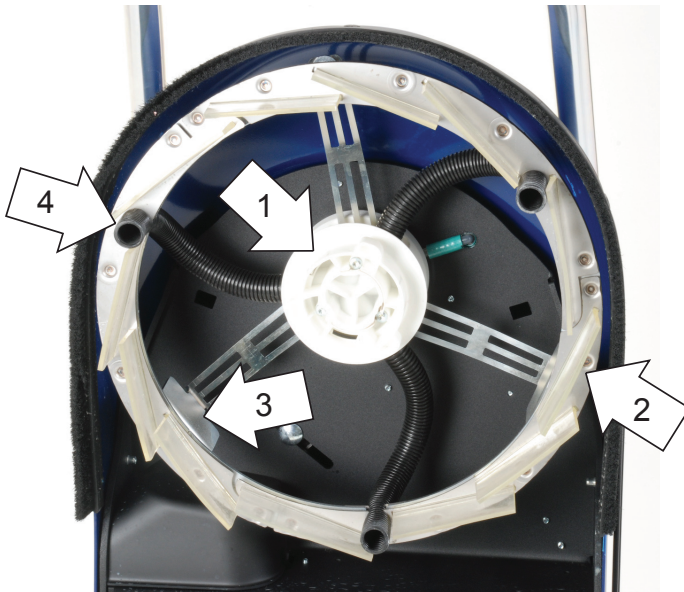

1. Hub
2. Squeegee Ring

3. Squeegee Ring Mounting Frame
4. Suction Hose

5. 8mm Nut

Adjustment of Suction Hoses



NOTICE: *Proper adjustment of the suction hoses is essential to good operation. Check hose adjustment on a regular basis.*

1. Pinch hose to allow insertion into squeegee ring.
2. End of suction hose should be approximately 1-3/16" from squeegee ring surface.

Weekly Maintenance

1. Make sure brush rotates freely.
2. Inspect water tank for leaks and that membrane separating clean and dirty water is in good condition.

Monthly Maintenance

1. Perform Weekly Maintenance.
2. Rinse water hoses by cleaning a section of a floor with a large amount of clean water.
3. Thoroughly clean gaskets around water tank.
4. Clean both fill and drain caps on water tank.
5. Clean inside of both clean water and dirty water tank.

After First 100 Hours of Use

Frequency of use and type of environment will dictate when some maintenance is performed. Lubricate casters with silicone grease or spray. Inspect entire machine for damage, loose screws, nuts and other parts.

Yearly Maintenance

It is recommended that you take your Qleeno to the nearest authorized service center for thorough inspection.

Before long periods of inactivity

1. Perform Monthly Maintenance.
2. Empty machine of all water.
3. Lubricate gaskets with silicone grease.

After long periods of inactivity

1. Inspect gaskets and wipe away excess silicone grease.
2. Perform monthly maintenance.

Approximate Critical Component Expected Lifetime

| | |
|------------------------------|-----------|
| Squeegee | 600 hrs. |
| Vacuum Tube | 600 hrs. |
| Brush | 1000 hrs. |
| AC Motor | 1000 hrs. |
| DC Motor (brush replacement) | 2500 hrs. |

| | |
|------------------|-----------|
| Timing Belt | 1500 hrs. |
| Water Pump | 1500 hrs. |
| Water Tank | 2000 hrs. |
| Casters | 2000 hrs. |
| Transport Wheels | 2000 hrs. |

REPLACEMENT PARTS

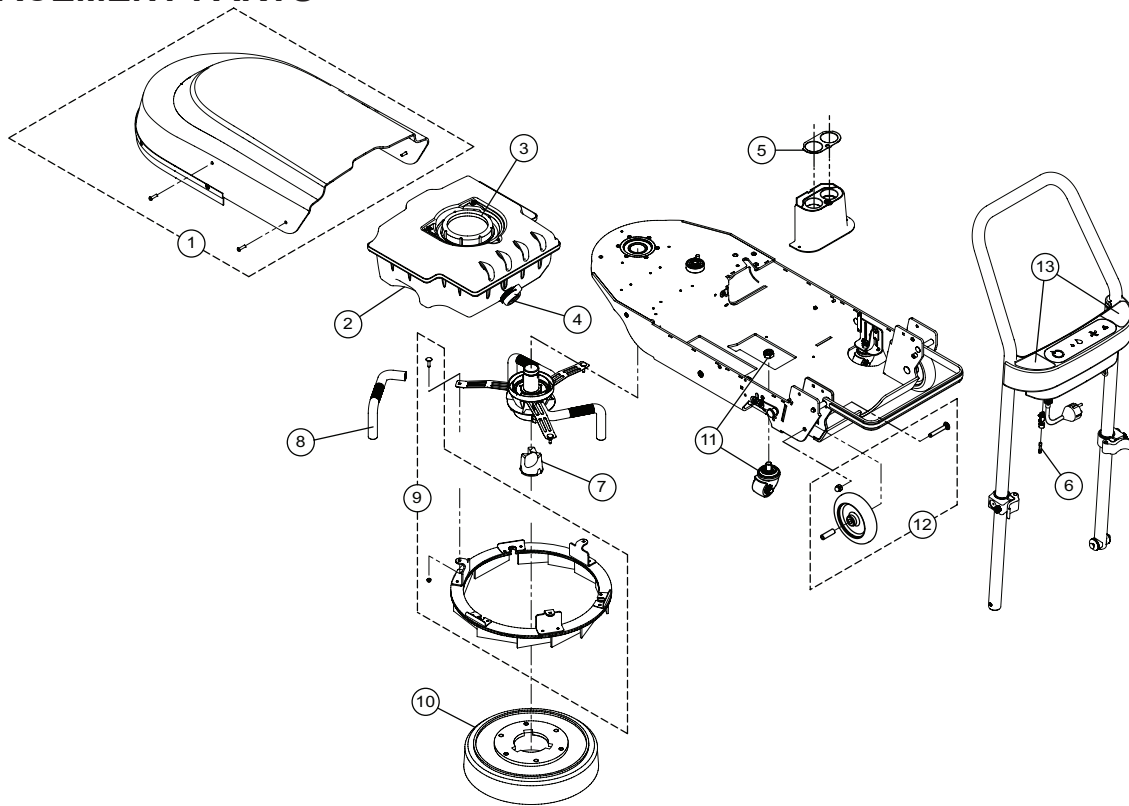

| Item | Part No. | Description | Qty |
|------|-------------------|---------------------------------------|-----|
| 1 | 710-3-9920-107 | Hood Assembly Repair Kit | 1 |
| 2 | 710-4-8700-104 | Water Tank Assy (includes parts 3, 4) | 1 |
| 3 | 710-3-9922-101 | Tank Fill (Large) Cap Repair Kit | 1 |
| 4 | 710-3-9921-109 | Tank Drain (Small) Cap Repair Kit | 1 |
| 5 | 710-6-8706-108 | Water Tank Gasket | 1 |
| 6 | 710-3-9903-107 | Fuse Repair Kit (includes 10 fuses) | 1 |
| 7 | 710-6-8105-102 | Water Distributor | 1 |
| 8 | 710-3-9916-106 | Vacuum Tube Repair Kit | 3 |
| 9 | 710-4-8500-106 | Squeegee Ring Assembly | 1 |
| 10 | 710-4-8501-108 | Brush | 1 |
| 11 | 710-3-9902-105 | Caster Repair Kit | 1 |
| 12 | 710-3-9901-103 | Transport Wheel Repair Kit | 1 |
| 13 | 710-6-8911-109 | Extension Cord, 14 AWG (not shown) | 1 |
| 14 | 710-3-9925-107 | Safety Labels | 3 |
| 15 | qleeno rev 082011 | Owner's Manual | 1 |

For information about Qleeno accessories, go to www.qleenousa.com

TWO YEAR LIMITED WARRANTY

Qleeno®, represented in the United States by **SFA COMPANIES** ("SFA") warrants to the original purchaser that this product is free from defects in material and workmanship for a period of two (2) years from date of purchase. The warranty is non-transferable and is subject to the terms, exclusions, and limitations described below:

- Any damage resulting from misuse or neglect including, but not limited to bent squeegee rings, dented or crushed machine hoods, broken welds or punctured rubber bladders as well as worn out seals, o-rings and springs are the result of misuse and not covered by warranty and no warranty credit will be provided for such damaged components.
- This warranty does not apply to ordinary wear and tear, overloading, alterations (including repairs or attempted repairs not performed by SFA or one of its authorized service centers).
- This warranty is voided by improper fluid use, or use of the product in any manner for which the product was not intended use of the product in accordance with the instructions or warnings provided with the product and any modifications of the product.
- In the unlikely event that a Qleeno product fails due to material defect in workmanship, you may contact SFA for disposition. Please contact our customer service department at (816) 891-6390 before proceeding with shipment or repairs on the product. In such cases, the customer's sole and exclusive remedy for any breach or alleged breach of warranty is limited to the repair or replacement of the defective product.
- Under no circumstances is SFA liable for any consequential such as lost profits or any other incidental damage whatsoever.
- THIS WARRANTY IS LIMITED TO NEW PRODUCTS SOLD THROUGH AUTHORIZED DISTRIBUTORS AND OTHER CHANNELS DESIGNATED BY SFA. NO AGENT, EMPLOYEE OR OTHER REPRESENTATIVE OF SFA, IS AUTHORIZED TO MODIFY THIS WARRANTY.
- THE FOREGOING IS EXCLUSIVE AND IS IN LIEU OF ALL OTHER EXPRESS AND IMPLIED WARRANTIES, INCLUDING BUT NOT LIMITED TO THE IMPLIED WARRANTIES OF MERCHANTABILITY AND FOR A FITNESS FOR A PARTICULAR PURPOSE. ALL OTHER WARRANTIES ARE EXPRESSLY DISCLAIMED. WARRANTY LAWS IN DIFFERENT LOCALITIES MAY VARY AND YOU MAY HAVE RIGHTS BY VIRTUE OF STATE OR LOCAL LAW.
- SFA's liability in all cases is limited to, and will not exceed the purchase price paid for the product.
- "Wear Items" such as accessories, motor carbon brushes, AC motor, squeegees, brushes, pads, vacuum tubes, wheels, casters, belts, bearings, and etc. are excluded unless found defective by Qleeno or SFA or an authorized service center.

Some states do not allow limitations on how long an implied warranty lasts, so the above limitation may not apply to you. Some states do not allow the exclusion or limitation of incidental or consequential damages, so the above limitation or exclusion may not apply to you. This warranty gives you specific legal rights, and you may also have other rights, which vary from state to state.



SFA Companies, Inc.
10939 N. Pomona Ave., Kansas City, MO 64153
816.891.6390
customerservices@shinnfuamerica.com