

# 88 5539 21 Geo Coffee Table

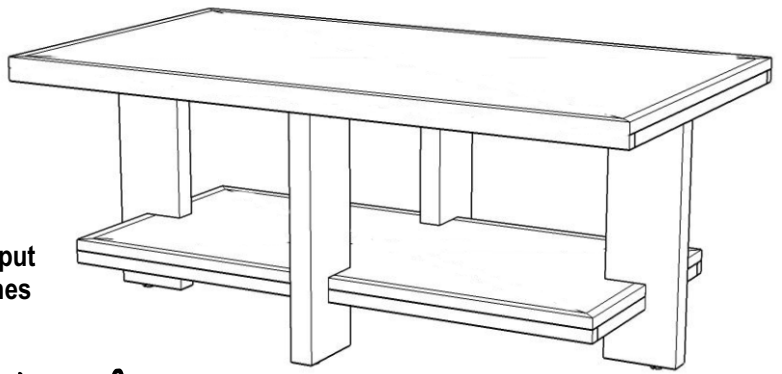

## IMPORTANT NOTE

Carefully remove all the parts from the carton and put them individually on a soft cloth to prevent scratches or other damages occurring to the wood parts.

We have taken great care in the design of this product and request that you carefully and strictly follow our assembly instructions to ensure a completed product as it was designed.

*Home Styles*

## Part List

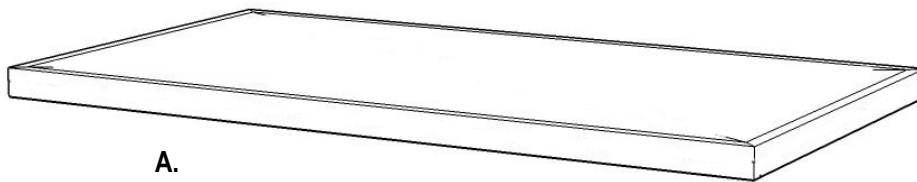

**A.**  
Top  
1 pc.

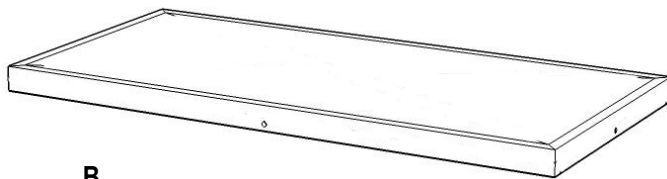

**B.**  
Shelf  
1 pc.

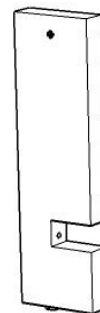

**C.**  
Leg  
4 pcs.

## Hardware List



**Hex Wrench**  
1 pc.



**Head Cap Bolt (long)**  
4 pcs. (+1 extra)



**Spring Washer**  
20 pcs. (+1 extra)

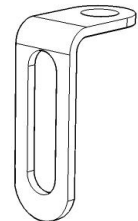

**Steel Plate connector**  
8 pcs. (+1 extra)



**Small Hex Wrench**  
1 pc.



**Head Cap Bolt (short)**  
16 pcs. (+1 extra)



**Flat Washer**  
20 pcs. (+1 extra)

Tools required for assembly : **Phillips** screwdriver

**Home Styles Consumer Assistance Line 888-680-7460 and 877-831-0319**  
**servicedesk@homestyles-furniture.com**

# Assembly Instructions

## IMPORTANT

You should keep Hex Wrench in a safe place as you may need to tighten up the Head Cap Bolts in the future.

## STEP 1

Attach 2X Steel Plate Connectors to each Legs (C) with Head Cap Bolts, Spring Washers and Flat Washers. (See figure 1)

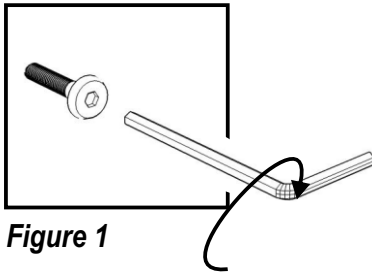
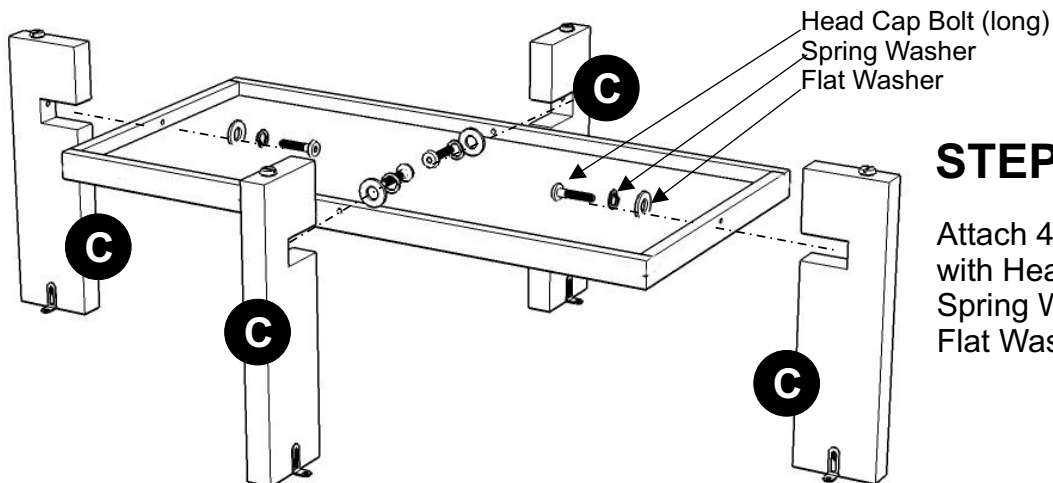
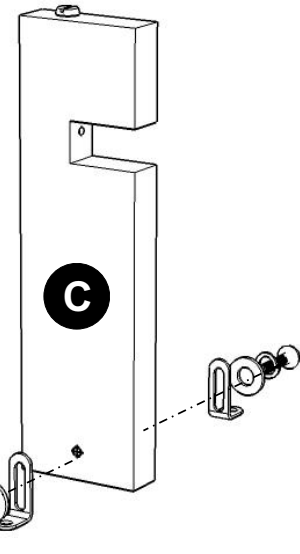

Figure 1

Steel Plate Connector  
Flat Washer  
Spring Washer  
Head Cap Bolt (short)



Head Cap Bolt (long)  
Spring Washer  
Flat Washer

## STEP 2

Attach 4X Leg (C) to Shelf (B) with Head Cap Bolts (long), Spring Washers and Flat Washers.

## STEP 3

Place Top (A) upside down on a soft cloth.

Attach unit in step 2 onto Top (A) with Head Cap Bolts (short), Spring Washers and Flat Washers.

Turn the unit to it's upright position.

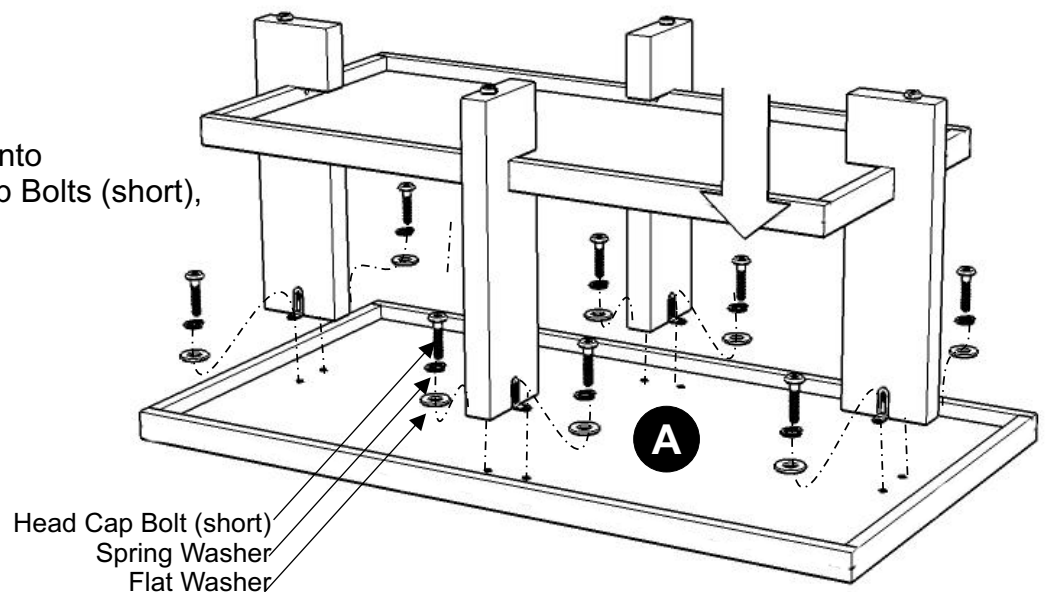

Head Cap Bolt (short)  
Spring Washer  
Flat Washer