

RiverRidge®

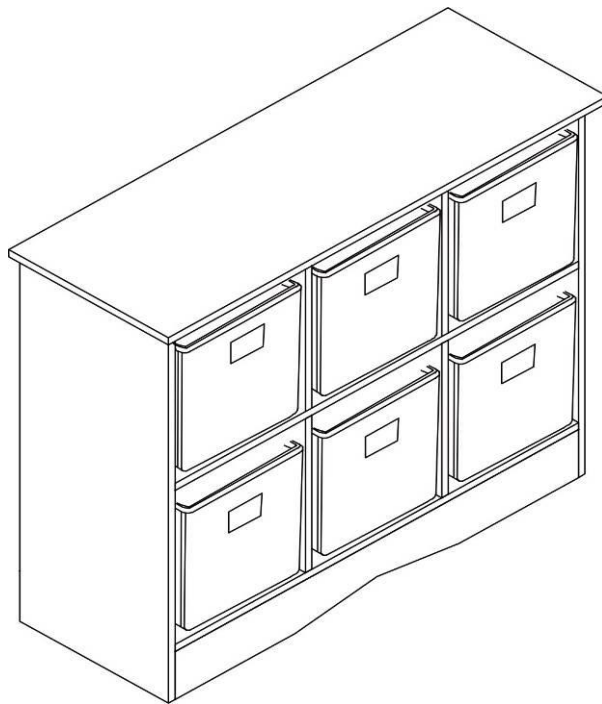

ASSEMBLY INSTRUCTIONS



6 BIN STORAGE CABINET

ITEM# 02-034/02-052/02-053

CAUTION: THIS STORAGE CABINET REQUIRES ASSEMBLY BY AN ADULT BECAUSE OF SMALL PARTS. CARE SHOULD BE TAKEN IN UNPACKING AND ASSEMBLING OF THIS ITEM.

WARNING

Young children may be injured or can be killed when furniture tips over.

Don't use this item as a TV stand.

Use angle-braces wall anchors or other type of tip restraint should be used to secure any furniture to a wall.

ADULT ASSEMBLY REQUIRED

SEND REQUESTS FOR MISSING OR DAMAGED PARTS REPLACEMENTS BY EMAIL TO:
customer.service@ssi-rr.com

WARNING: THIS SHELF UNIT WILL HOLD UP TO 25 POUNDS PER SHELF OR A TOTAL OF 75 POUNDS. DO NOT LOAD EACH SHELF WITH MORE THAN 25 POUNDS. IF LOADED WITH MORE THAN 25 POUNDS PER SHELF AS THIS MAY CAUSE DAMAGE TO THE SHELF AND MAY CAUSE SERIOUS INJURY OR DEATH













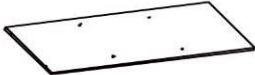
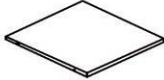

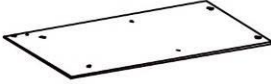
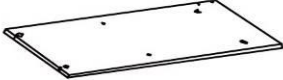

WARNING

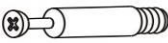
Serious or fatal crushing injuries can occur from furniture tip-over. To help prevent tip-over:

- Place heaviest items in the lowest drawers
 - Unless specifically designed to accommodate, do not set TVs or other heavy objects on top of this product.
 - Never allow children to climb or hanging on drawers, doors or shelves.
 - Never open more than one drawer at a time.
- (OR)
- Do not defeat or remove drawer interlock system.

Use of tip-over restraints may only reduce, but not eliminate the risk of tip-over.

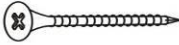
PARTS LIST

| NO | PARTS | QTY | DESCRIPTION |
|----------|---|-------|-------------------------|
| A |  | 1PC | BOTTOM BOARD |
| B |  | 4PCS | DIVIDER PANEL |
| C |  | 1PC | DECORATIVE PANEL |
| D |  | 1PC | SHELF |
| E |  | 1PC | LEFT SIDE PANEL |
| F |  | 1PC | RIGHT SIDE PANEL |
| G |  | 1PC | TOP BOARD |
| H |  | 2PCS | BACK BOARD |
| J |  | 6PCS | STORAGE BIN |
| 1 |  | 8PCS | CAM BOLT |
| 2 |  | 8PCS | CAM LOCK |
| 3 |  | 4PCS | LONG WOOD DOWEL |
| 4 |  | 18PCS | SHORT WOOD DOWEL |
| 5 |  | 22PCS | Back screw M2.5x16mm |
| 6 |  | 2PCS | Bracket |
| 7 |  | 1PC | Plastic anchor |
| 8 |  | 1PC | Wall screw M3.5x30mm |
| 9 |  | 1PC | 11" Cable |

TOOLS NEEDED FOR A SSEMBLY: FLAT &PHILIPS SCREW DRIVER (NOT INCLUDED), THE USE OF A POWER SCREWDRIIVER IS NOT RECOMMENDED

STEP 1

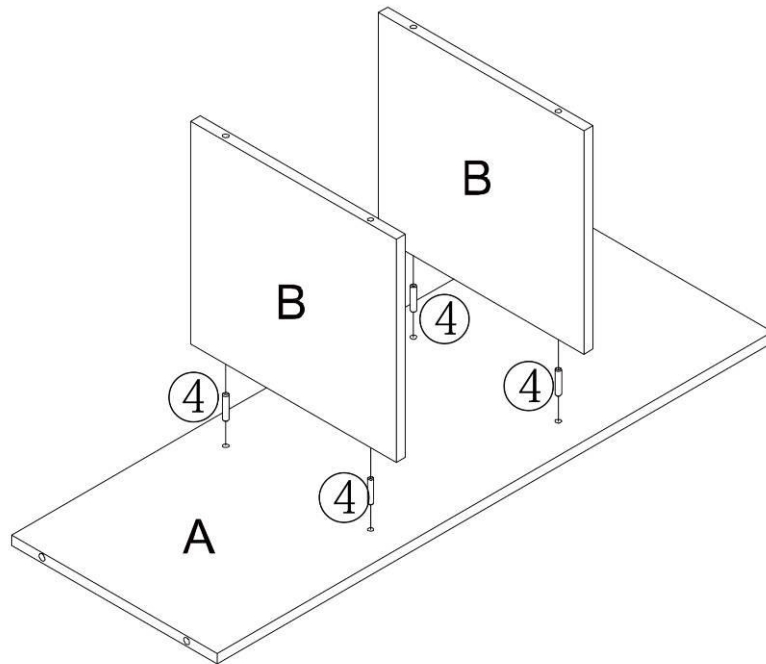

STEP 1

1. Insert 4 wood dowels (4) into the pre-drilled holes on the bottom board (A).
2. Attach the divider panels (B) to the bottom board (A), by inserting wood dowels (4) into the wood dowel holes on the divider panels (B).

STEP 2

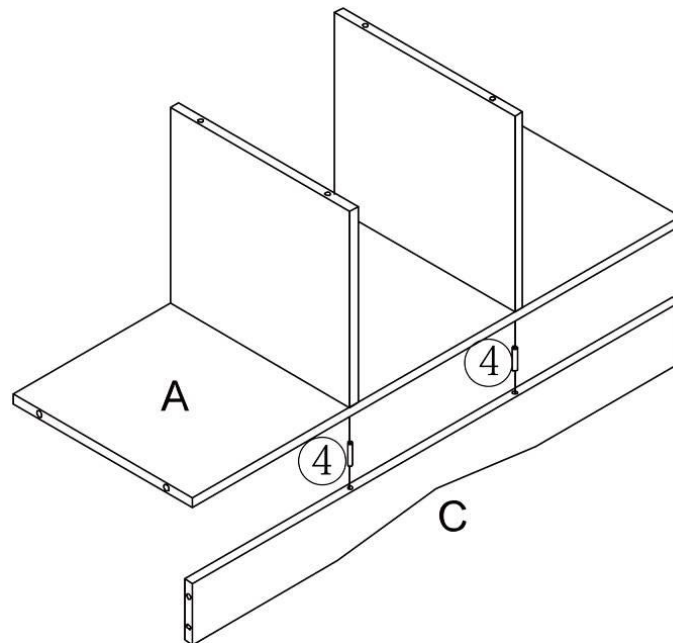

STEP 2

1. Insert 2 wood dowels (4) into the pre-drilled holes on the bottom of bottom board (A).
2. Attach the decorative panel (C) to the bottom board (A), by inserting wood dowels (4) into the wood dowel holes on the decorative panel (C).

STEP 3

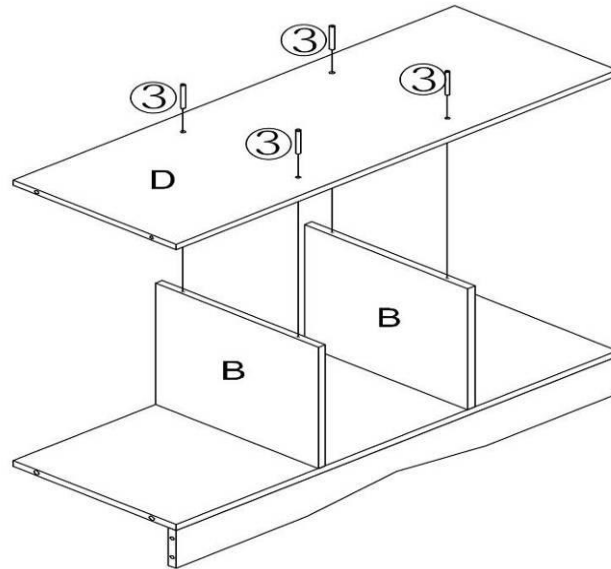

STEP 3

1. Attach the shelf (D) to the divider panels (B) by inserting 4 long wood dowels (3) through the pre-drilled holes on the divider panels (B).

STEP 4

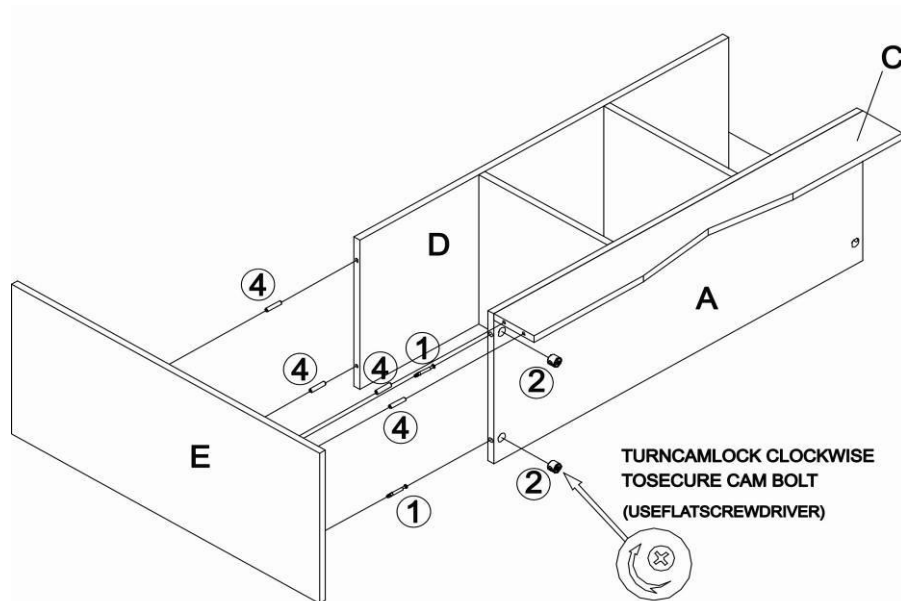

STEP 4

1. Insert 4 wood dowels (4) into the pre-drilled holes on the left side panel (E).
2. Screw in 2 cam bolts (1) into the pre-threaded holes on the left side panel (E).
3. Attach the left side panel (E) to the bottom board (A), the shelf (D), and decorative panel (C) by inserting cam bolts (1), and wood dowels (4) into cam lock holes and wood dowel holes on the bottom board (A), the shelf (D) and decorative panel (C)
4. Insert 2 cam locks (2) into cam lock holes on the bottom board (A), and rotate clockwise to lock the cam bolts (1) in place.

STEP 5

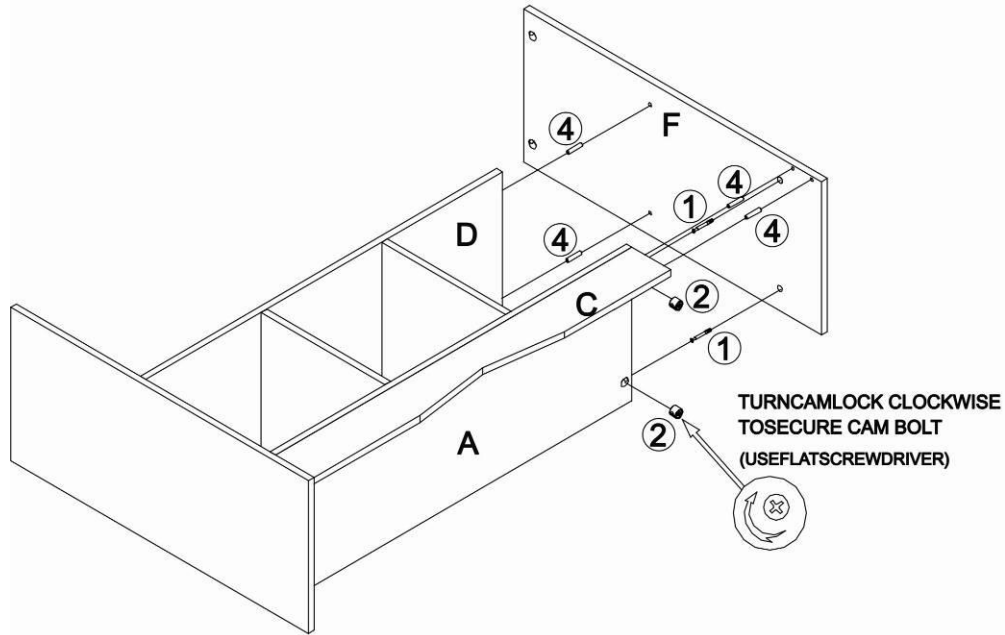

STEP 5

1. Insert 4 wood dowels (4) into the predrilled holes on the right side panel (F).
2. Screw in 2 cam bolts (1) into the pre-threaded holes on the right side panel (F).
3. Attach the right side panel (F) to the bottom board (A), the shelf (D), and decorative panel (C) by inserting cam bolts (1), and wood dowels (4) into cam lock holes and wood dowel holes on the bottom board (A), the shelf (D) and decorative panel (C)
4. Insert 2 cam locks (2) into cam lock holes on the bottom board (A), and rotate clockwise to lock the cam bolts (1) in place.

STEP 6

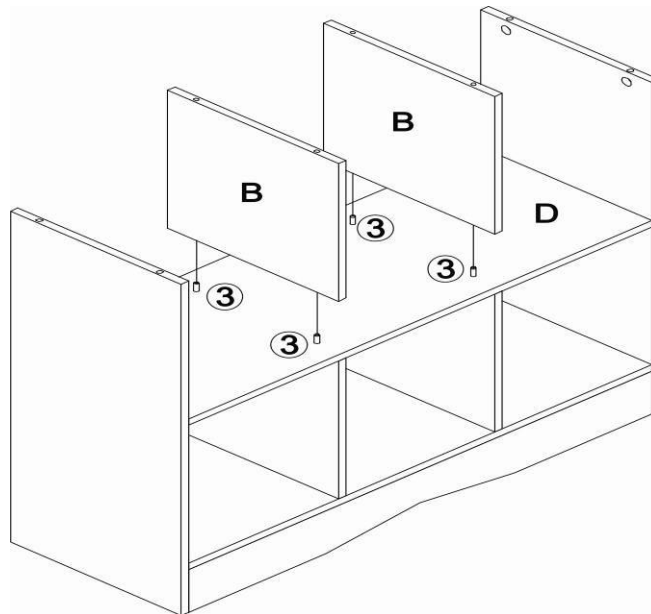

STEP 6

1. Attach the divider panels (B) to the shelf (D) by inserting long wood dowels (3) into the wood dowel holes on the divider panels (B).

STEP 7

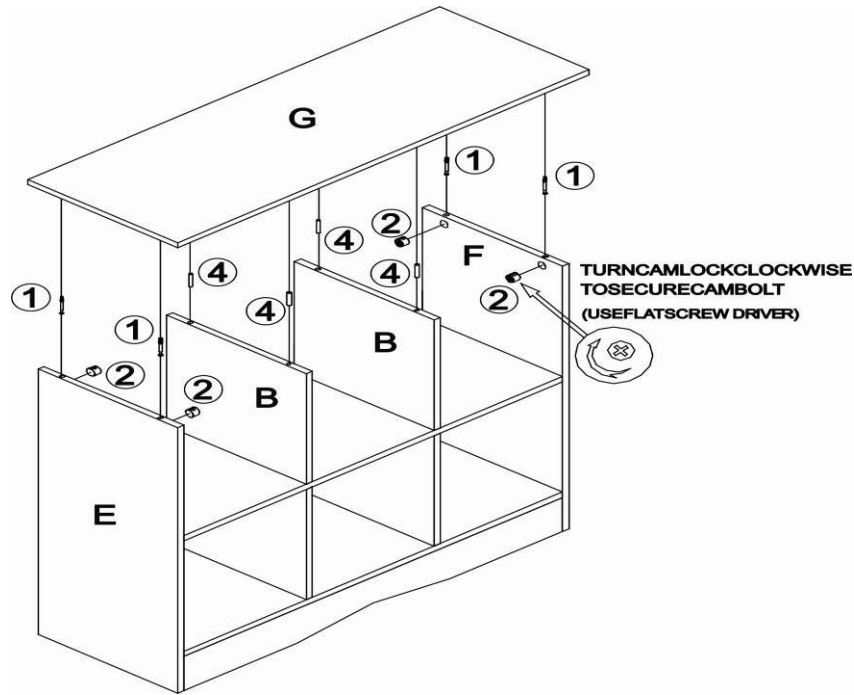

STEP 7

1. Insert 4 wood dowels (4) into the pre-drilled holes on the bottom of top board (G).
2. Screw in 4 cam bolts (1) into the pre-threaded holes on the bottom of top board (G).
3. Attach the top board (G) to the both side panels (E),(F), and the divider panels (B) by inserting cam bolts (1), and wood dowels (4) into cam lock holes and wood dowel holes on the both side panels (E),(F), and the divider panels (B)
4. Insert 2 cam locks (2) into cam lock holes on the both side panels (E),(F), and rotate clockwise to lock the cam bolts (1) in place.

STEP 8

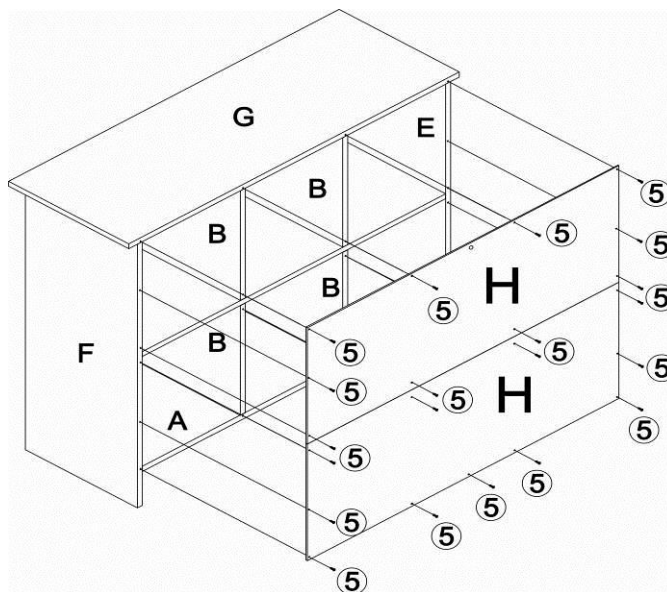

STEP 8

attach the 2 back boards (H) to the back of cabinet by inserting 20 wood screws (5) into the holes on the back boards (H), and tighten into the back of cabinet by using a Philips screwdriver.

STEP 9

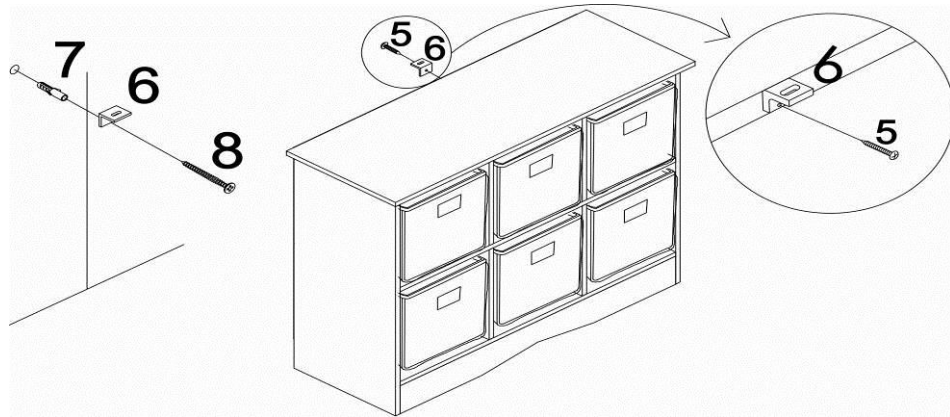

STEP 9

1. Attached one bracket (6) to the back of assembled cabinet by insert 1pc wood Screw (5) through the hole on the bracket(6), then tighten into the top board (G).↵
2. According to the height of bracket(6) that was assembled to the storage cabinet, drill one hole on the wall.↵
3. Insert the plastic anchor (7) into the hole on the wall.↵
4. Attach another one bracket (6) to the plastic anchor (7) on the wall by inserting the wall screw (5) through the hole on the bracket (6) and tighten into the plastic anchor (7).↵

STEP 10

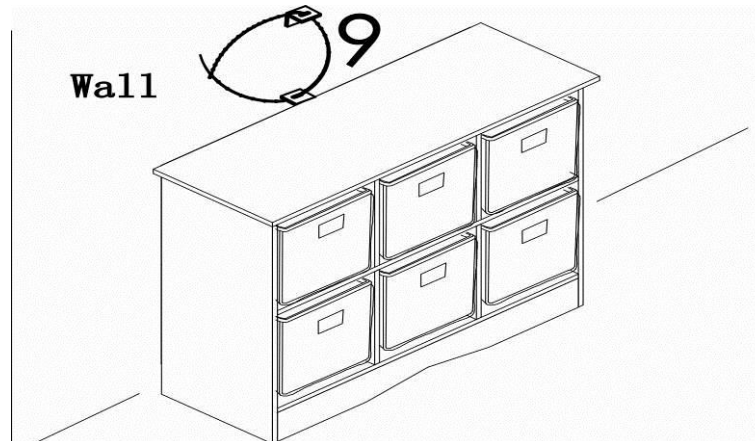

STEP 10

1. Place the storage cabinet against the wall and close to the bracket (6).↵
2. Insert plastic lock strap (9) through the hole on the bracket (6) which assembled on the storage cabinet, then through the hole on the bracket (6) on the wall, then fasten the plastic lock strap (9) to fix the 2 bracket (6) firmly.↵

STEP 11

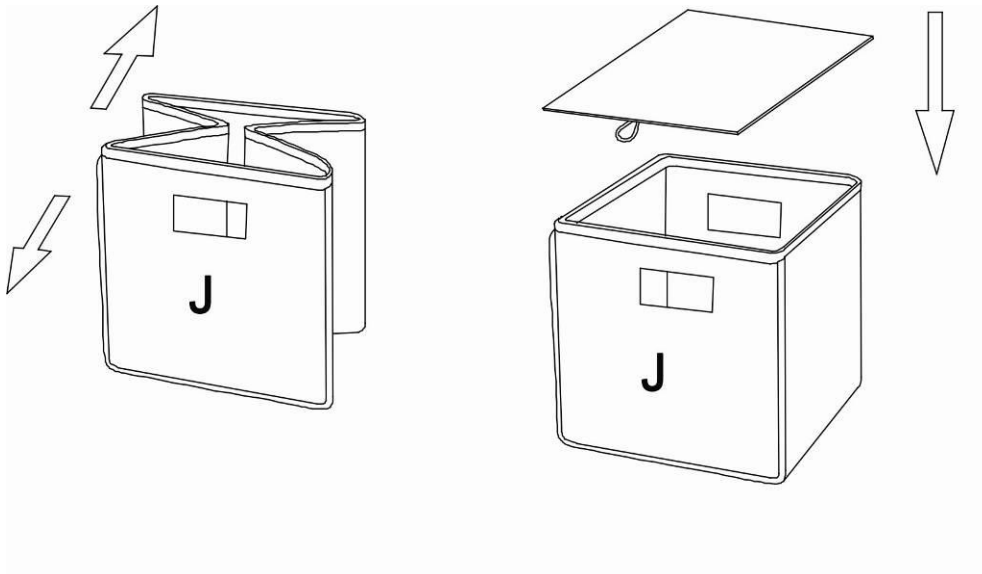

STEP 11

1. Take the bottom board out from the folded soft bin (J)
2. Open the folded storage bin, then put the bottom board into the soft bin (J). (making sure the cloth tab is facing up)

STEP 12

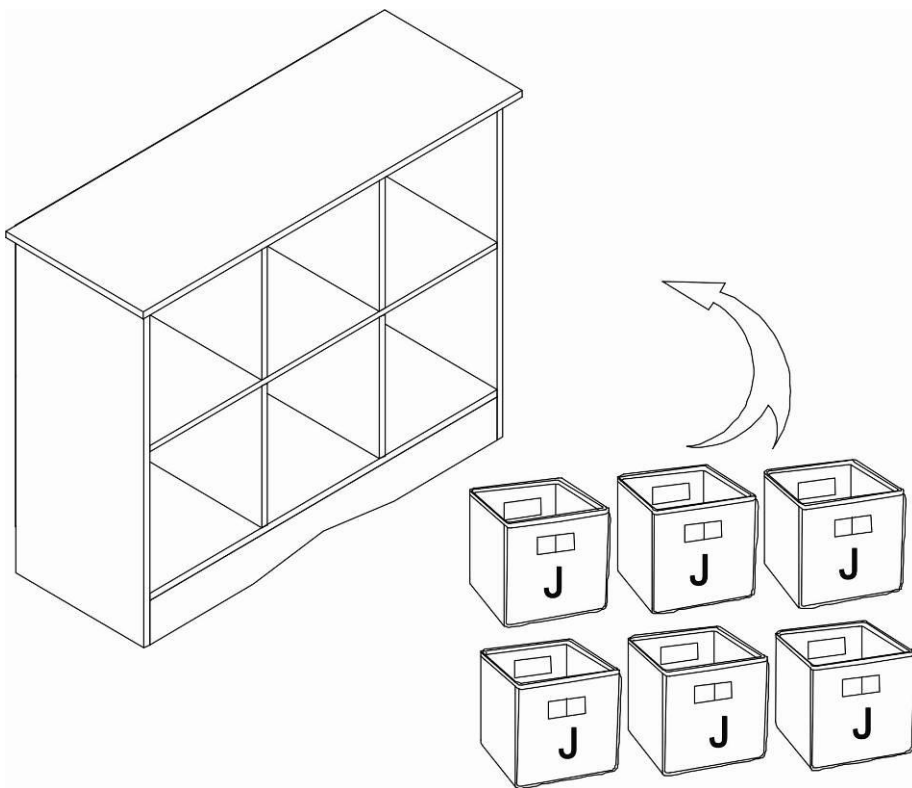

STEP 12

1. Put the 6 small storage bin into the cabinet unit.

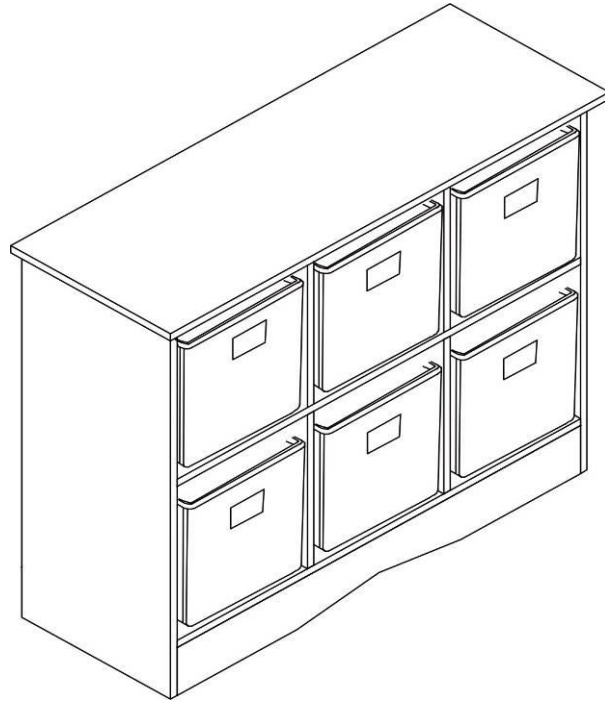

Now you can enjoy your new storage cabinet !

Attention Adults: This storage cabinet should be checked periodically for damage or loose parts/screws. Take appropriate action necessary to correct the hazard such as tightening of screws and taking any damaged parts away from the child.

Thank you for purchasing these RiverRidge Kids items. We hope you enjoy them.

You can contact us at customer.service@ssi-rr.com with any questions or comments.