



CUBO 20 design SLIDE Studio



Lampada da terra / tavolo
 Anno di produzione: 1999
 Versioni: luminosa.
 Materiali: Polietilene.
 Dimensioni: 20 x 20 h 20 cm
 Peso: 0,7 Kg
 Imballaggio: 21 x 21 x 26 cm
 Volume imballaggio: 0,011 m³

Lampadaire / lampe de table
 Année de production: 1999
 Versions: lumineuse.
 Matériaux: Polyéthylène.
 Dimensions: 20 x 20 h 20 cm
 Poids: 0,7 Kg
 Emballage: 21 x 21 x 26 cm
 Volume emballage: 0,011 m³

Floor lamp / table lamp
 Year of production: 1999
 Versions: lighting.
 Material: Polyethylene.
 Dimensions: 20 x 20 h 20 cm
 Weight: 0,7 Kg
 Packaging: 21 x 21 x 26 cm
 Packaging volume: 0,011 m³

DIMENSIONS (cm)			
CODE	LP CUB020	LP CUE021	
LIGHTING	1x	1x Note: earth spike on demand	
COLOURS	LIGHTING COLOURS <input type="radio"/> LIGHT WHITE (code LA) <u>GLOSSY FINISH</u>	LIGHTING COLOURS <input type="radio"/> LIGHT WHITE (code LA) <u>GLOSSY FINISH</u>	1x Energy saving bulb recommended (not included).



CUBO 30 design SLIDE Studio



Lampada da terra / tavolo
 Anno di produzione: 2001
 Versioni: luminosa.
 Materiali: Polietilene.
 Dimensioni: 30 x 30 h 30 cm
 Peso: 2,4 Kg
 Imballaggio: 31 x 31 x 34 cm
 Volume imballaggio: 0,033 m³

Lampadaire / lampe de table
 Année de production: 2001
 Versions: lumineuse.
 Matériaux: Polyéthylène.
 Dimensions: 30 x 30 h 30 cm
 Poids: 2,4 Kg
 Emballage: 31 x 31 x 34 cm
 Volume emballage: 0,033 m³

Floor lamp / table lamp
 Year of production: 2001
 Versions: lighting.
 Material: Polyethylene.
 Dimensions: 30 x 30 h 30 cm
 Weight: 2,4 Kg
 Packaging: 31 x 31 x 34 cm
 Packaging volume: 0,033 m³

DIMENSIONS (cm)			
CODE		LP CUB031 LP CUE031	LP CUB032 LP CUE032
LIGHTING		1x I2 / E2 Note: earth spike on demand	1x E3 / I3 SMALL Note: earth spike on demand
COLOURS		LIGHTING COLOURS <input type="radio"/> LIGHT WHITE (code LA) <u>GLOSSY FINISH</u>	LIGHTING COLOURS <input type="radio"/> LIGHT WHITE (code LA) <u>MATT FINISH</u>
		1x 15W Energy saving bulb recommended (not included).	



CUBO 40 design SLIDE Studio



Lampada da terra / tavolo
 Anno di produzione: 2002
 Versioni: luminosa.
 Materiali: Polietilene.
 Dimensioni: 43 x 43 h 43 cm
 Peso: 4,1 Kg
 Imballaggio: 45 x 45 x 46 cm
 Volume imballaggio: 0,093 m³

Lampadaire / lampe de table
 Année de production: 2002
 Versions: lumineuse.
 Matériaux: Polyéthylène.
 Dimensions: 43 x 43 h 43 cm
 Poids: 4,1 Kg
 Emballage: 45 x 45 x 46 cm
 Volume emballage: 0,093 m³

Floor lamp / table lamp
 Year of production: 2002
 Versions: lighting.
 Material: Polyethylene.
 Dimensions: 43 x 43 h 43 cm
 Weight: 4,1 Kg
 Packaging: 45 x 45 x 46 cm
 Packaging volume: 0,093 m³

DIMENSIONS (cm)			
CODE		LP CUB041 LP CUE041	LP CUB042 LP CUE042
LIGHTING		1x I2 / E2 Note: earth spike on demand	1x E3 / I3 MEDIUM Note: earth spike on demand
COLOURS		LIGHTING COLOURS <input type="radio"/> LIGHT WHITE (code LA) <u>GLOSSY FINISH</u>	LIGHTING COLOURS <input type="radio"/> LIGHT WHITE (code LA) <u>MATT FINISH</u>
		1x 25W Energy saving bulb recommended (not included).	



CUBO 50 design SLIDE Studio



Lampada da terra
 Anno di produzione: 2007
 Versioni: luminosa.
 Materiali: Polietilene.
 Dimensioni: 50 x 50 h 60 cm
 Peso: 8 Kg
 Imballaggio: 51 x 51 x 62 cm
 Volume imballaggio: 0,161 m³

Lampadaire
 Année de production: 2007
 Versions: lumineuse.
 Matériaux: Polyéthylène.
 Dimensions: 50 x 50 h 60 cm
 Poids: 8 Kg
 Emballage: 51 x 51 x 62 cm
 Volume emballage: 0,161 m³

Floor lamp
 Year of production: 2007
 Versions: lighting.
 Material: Polyethylene.
 Dimensions: 50 x 50 h 60 cm
 Weight: 8 Kg
 Packaging: 51 x 51 x 62 cm
 Packaging volume: 0,161 m³

DIMENSIONS (cm)			
CODE		LP CUB051 LP CUE051	
LIGHTING		1x Note: earth spike on demand	
		1x 25W Energy saving bulb recommended (not included).	
COLOURS		LIGHTING COLOURS <input type="radio"/> LIGHT WHITE (code LA) <u>GLOSSY FINISH</u>	



CUBO 75 design SLIDE Studio



Lampada da terra
 Anno di produzione: 2005
 Versioni: luminosa.
 Materiali: Polietilene.
 Dimensioni: 73 x 73 h 73 cm
 Peso: 20 Kg
 Imballaggio: 80 x 80 x 80 cm
 Volume imballaggio: 0,512 m³

Lampadaire
 Année de production: 2005
 Versions: lumineuse.
 Matériaux: Polyéthylène.
 Dimensions: 73 x 73 h 73 cm
 Poids: 20 Kg
 Emballage: 80 x 80 x 80 cm
 Volume emballage: 0,512 m³

Floor lamp
 Year of production: 2005
 Versions: lighting.
 Material: Polyethylene.
 Dimensions: 73 x 73 h 73 cm
 Weight: 20 Kg
 Packaging: 80 x 80 x 80 cm
 Packaging volume: 0,512 m³

DIMENSIONS (cm)			
CODE			LP CUB076 LP CUE076
LIGHTING			1x Note: earth spike on demand
COLOURS			LIGHTING COLOURS <input type="radio"/> LIGHT WHITE (code LA) <u>MATT FINISH</u>
		1x 65W	Energy saving bulb recommended (not included).



CUBO COMPONENTS



DIMENSIONS (cm) - CODE - COLOURS







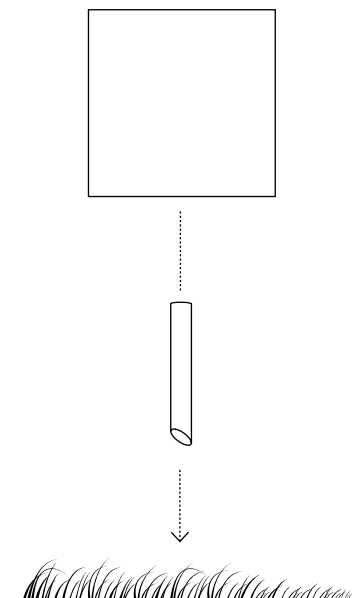
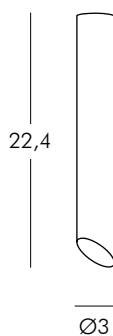







EARTH SPIKE

Material: metal.
Weight: 0,1 Kg
Note: not included.













LP TUB002





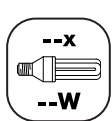

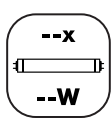
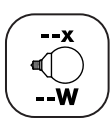
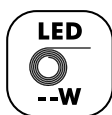





SYMBOLS

 For indoor use.	 Insulation class 1.	 Protected against the intrusion of solid objects $\varnothing > 12$ mm, not against water.
 For indoor and outdoor use.	 Insulation class 2.	 Protected against the intrusion of solid objects $\varnothing > 1$ mm and splashing water.
 Stackable item.	 Insulation class 3.	 Protected against the intrusion of dust and water jets.
 Conformity to the European Community instructions.	 Device proper to direct assembly onto normally inflammable surfaces.	 Fully protected against the intrusion of dust and immersion in water.
 European Community registered model.	 100% recyclable polyethylene.	 Recycling and disposal of electronic waste (WEEE).

LIGHTING SYMBOLS

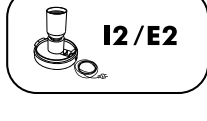
 Small lamp base for E14 - 14 mm light bulb.	 Lamp base for G13 neon tube.	 LED technology lighting system.
 Medium lamp base for E26 - 26 mm light bulb.	 Lamp base for GU10 spotlight.	 Neon tube lighting system.
 Standard lamp base for E27 - 27 mm light bulb.	 Lamp base for G4 halogen bulb.	
 Lighting through energy saving bulb. The upper figure shows the number of allowed bulbs. The lower figure shows the MAXIMUM recommended power.	 Lighting through energy saving fluorescent spotlight. The upper figure shows the number of allowed spotlights. The lower figure shows the MAXIMUM recommended power.	
 Lighting through neon tube. The upper figure shows the number of allowed neon tubes. The lower figure shows the MAXIMUM recommended power.	 Lighting through energy saving globe bulb. The upper figure shows the number of allowed bulbs. The lower figure shows the MAXIMUM recommended power.	
 Lighting through flexible LED tube. The lower figure shows the MAXIMUM recommended power.	 Lighting through circular T9 neon tube. The upper figure shows the number of allowed neon tubes. The lower figure shows the MAXIMUM recommended power.	

WIRING SYMBOLS

 Wiring with metal clamp. IP20 protection. Diameter 11 cm.	 Wiring with special base for KIT LED 1,5 WATT. IP55 protection. Diameter 11,6 cm.
 Wiring with metal base. IP55 protection. Diameter 10 cm. Fastening by hex screw key.	 Wiring with plastic screw base. I3 - IP20 protection. E3 - IP55 protection. Diameter 6 cm.
 Wiring with metal base. IP55 protection. Diameter 20 cm. Fastening by hex screw key.	 Wiring with plastic screw base. I3 - IP20 protection. E3 - IP55 protection. Diameter 10 cm.
 Wiring with plastic base and metal inserts. I2 - IP20 protection. E2 - IP55 protection. Diameter 10 cm. Fastening by slot screwdriver.	 Wiring with plastic screw base. I3 - IP20 protection. E3 - IP55 protection. Diameter 15 cm.
 Wiring with plastic base for LED LP RGB100. IP44 protection. Diameter 10 cm.	 Special metal base. IP20 protection. Several sizes.

MATERIAL PROPERTIES

Material: Linear low-density polyethylene - LLDPE.

Production process: rotational moulding.

Resistant to extreme temperatures (-60°C to +80°C).

UV resistant (except for lighting colours).

High tensile strength.

WARNING

- Keep away from excessive heat sources.
- Avoid any improper use. Do not stand on the products. When the product has to be moved, lift the product off the ground in order to avoid damage.
- Do not overload the pot structure in order to avoid deforming.
- Carefully comply with the maintenance & cleaning instructions.
- In case of malfunctioning or damage of the wiring or any electrical parts, refer to a qualified electrician.

MAINTENANCE & CLEANING

- To prevent dust and dirt from sticking to the plastic surfaces, periodically clean the products with a damp cloth and neutral liquid soap diluted in water.
- Avoid using ethanol or any liquids containing, even in small amounts, acetone, trichloroethylene or ammonia (solvents in general).
- It is recommended the use of SLIDE's "CleanUp" cleaner or a degreaser. Spray the cleaning product on the surface, rub with a damp cloth and rinse abundantly with water (preferably with a high pressure washer). In case of persistent stains use a high pressure washer or scrub eraser. The use of the scrub eraser (melamine foam - Scotch-Brite® Easy Eraser or similar) is only recommended for white colour, as they are slightly abrasive.
- The lacquered version is also suitable for outdoor use, however it is more sensitive to scratches: periodically clean with a polish cleaner, gently rubbing with soft cloth/cotton wool.
- Cushions can be cleaned with a damp cloth, neutral liquid soap and water.
- For metal parts use specific cleaners.

SUSTAINABILITY & RECYCLING

All SLIDE products are 100% recyclable. Furthermore, grey, black and chocolate matt colours are produced with recycled polyethylene. SLIDE has a closed production cycle with no health prejudicial emissions and complying with ecological sustainability rules.

When a product reaches the end of its life, do not treat the product or any of its parts as domestic waste. Dispose by sending to differentiated collection centres.

RESPONSIBILITY & RETURNS

SLIDE declines any liability to damages caused to things or persons by an illegitimate use of the product. SLIDE won't accept any returned goods without having checked the kind of defects first.

WARRANTY

SLIDE products are guaranteed against all manufacturing faults, granted that the items are appropriately used, for twenty-four (24) months from the date of purchase upon presentation of the invoice.

LED KITS only are guaranteed for twelve (12) months from the date of purchase.

Warranty doesn't include parts that are subject to wear and tear due to usage, batteries when provided, wiring and electrical parts that do not have manufacturing faults.