

**W** Walker  
Edison  
furniture company

Item #: V35MWF  
Assembly Instructions

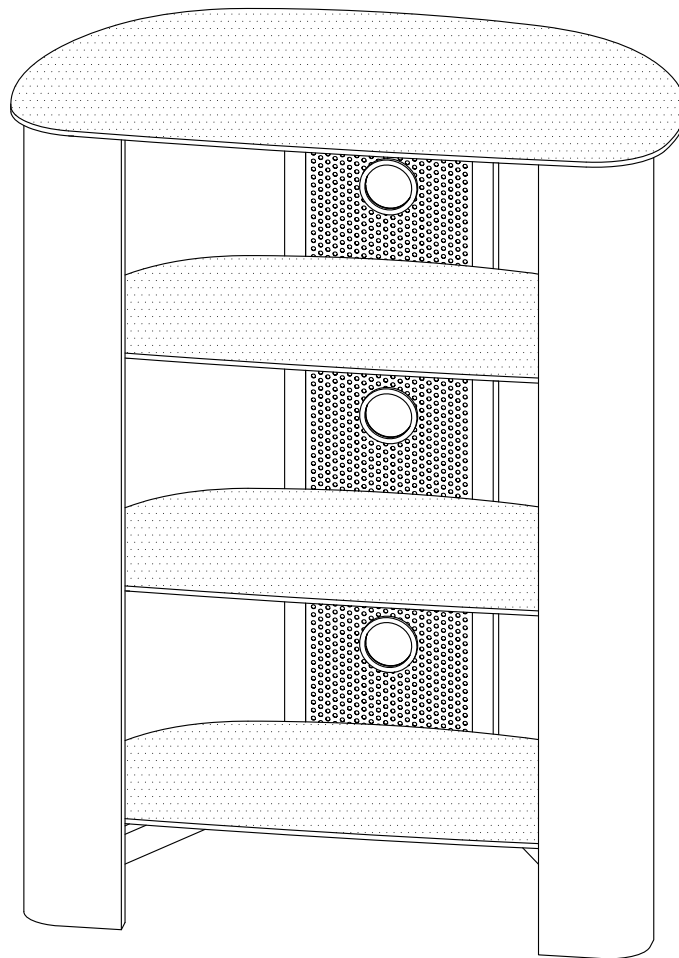







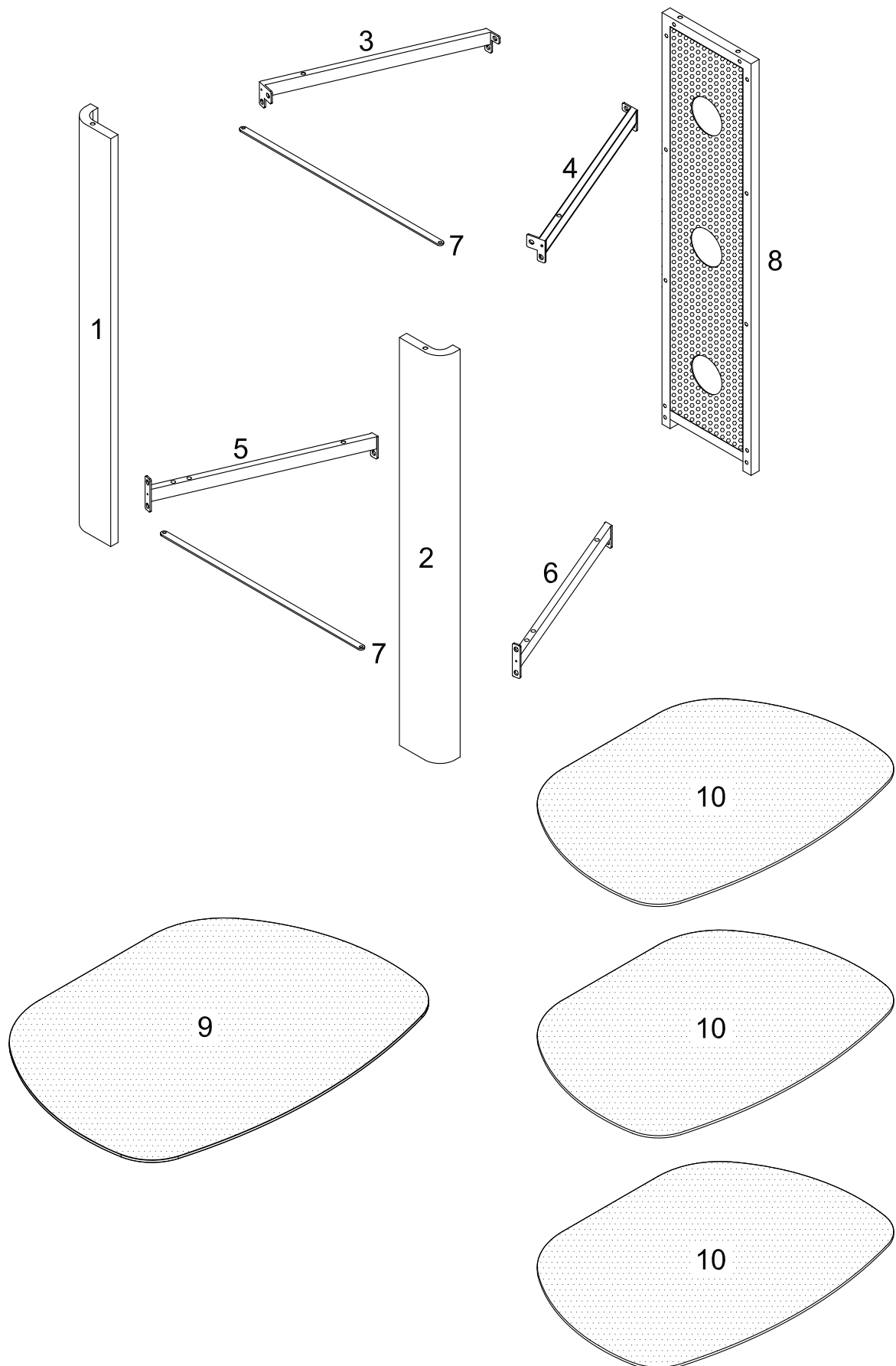

*For our most current instructions, to request missing, lost or broken parts, or for any other Customer Service issues, please visit our website at [www.walkeredison.com](http://www.walkeredison.com) or call us at 877-207-5906.*

Revised 07/2012

# Parts List



# Hardware List

A		Ø1/4"x1/2"	Screw	14 pcs
B		Ø1/4"x1-1/8"	Screw	2 pcs
C		Ø1/4"x3/8"	Screw	4 pcs
D		Ø19x22mm	Suction cup	4 pcs
E		Ø1/4"x1/2"	Pin	8 pcs
F		Ø20mm	Rubber pad	2 pcs
G			Suction cup	2 pcs
H		M4	Wrench	1 pc

*The hardware quantities listed above are required for proper assembly.  
Some extra hardware may also have been included.*

# Step 1

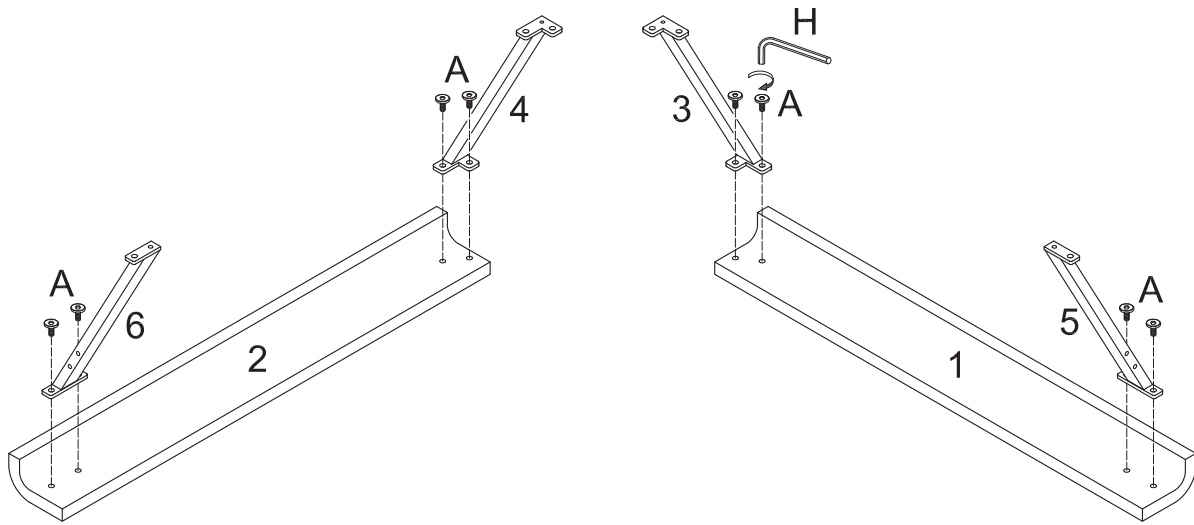

Attach crossbars (4,6) to front panel (2) using screws (A). Attach crossbars (3,5) to front panel (1) using screws (A). Tighten screws (A) with wrench (H).

# Step 2

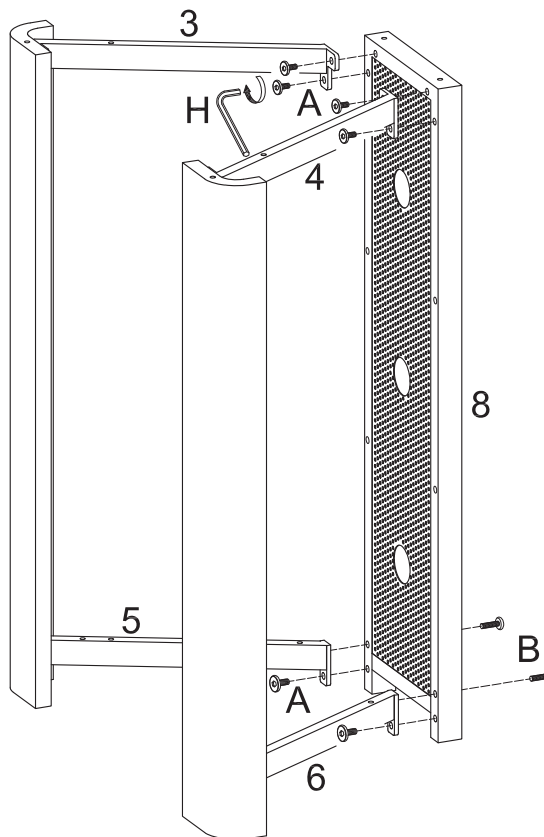

Attach crossbars (3,4) to cable management system (8) using screws (A). Attach crossbars (5,6) to cable management system (8) using both screws (A) and screws (B). *It may be necessary to loosen the screws from Step 1 slightly to align the crossbars properly with the cable management system.* Tighten all screws firmly with wrench (H).

## Step 3

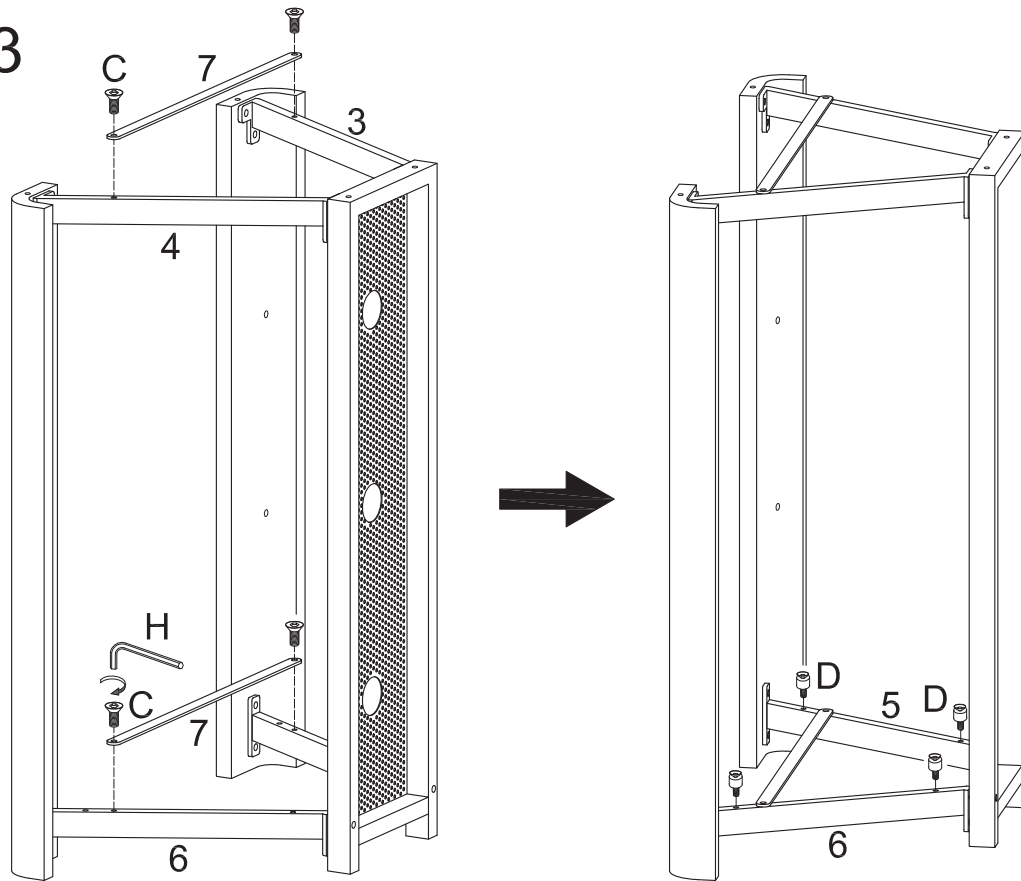

Attach support bars (7) to crossbars (3,4) and crossbars (5,6) using screws (C). Tighten screws (C) with wrench (H). Screw suction cups (D) into crossbars (5,6).

## Step 4

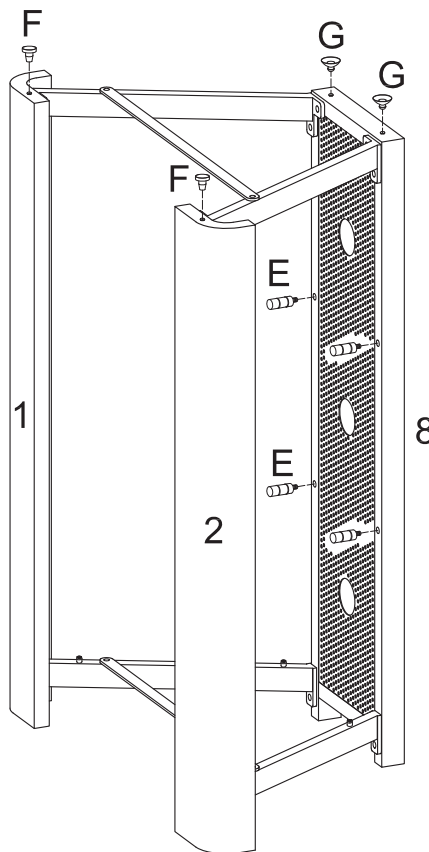

Screw pins (E) into cable management system (8). Insert rubber pads (F) into front panels (1,2). Insert suction cups (G) into cable management system (8).

## Step 5

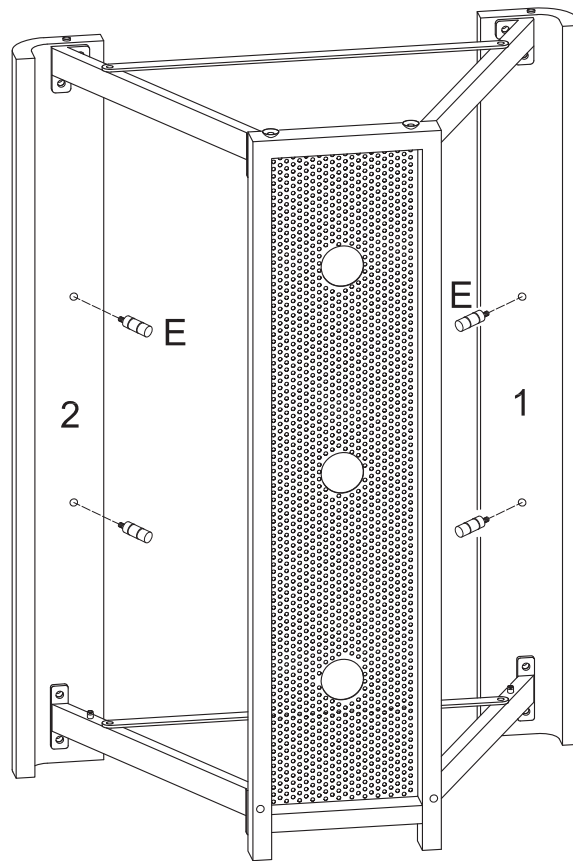

Gently screw pins (E) into front panels (1,2). **Do not use wrench to tighten pins (E), hand tighten only.**

## Step 6

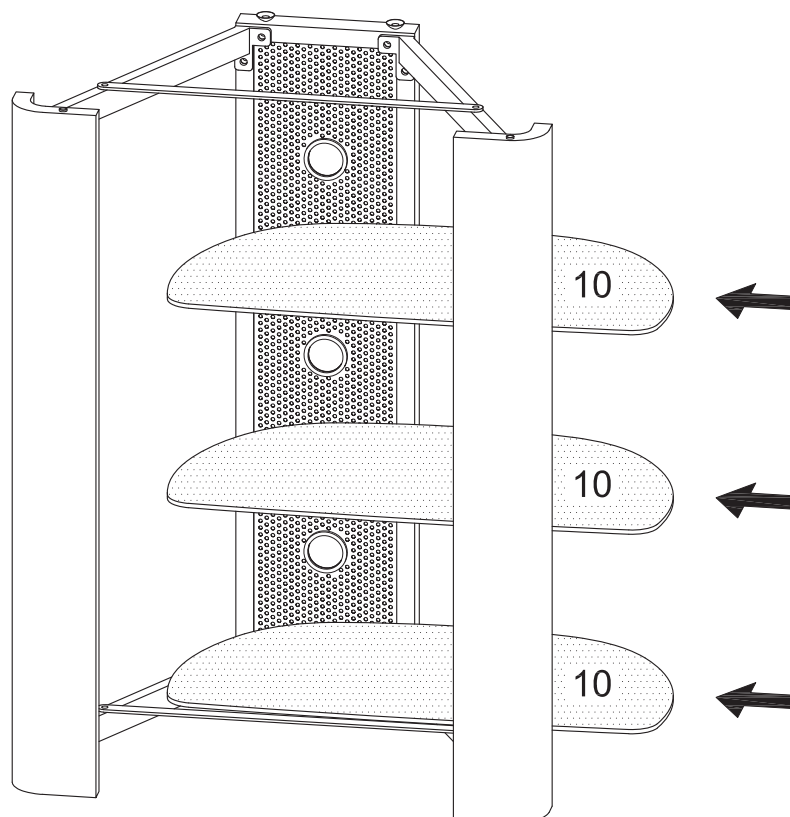

Carefully slide glass shelves (10) into place. *The glass shelves will rest on the pins placed in Steps 4 and 5.*

## Step 7

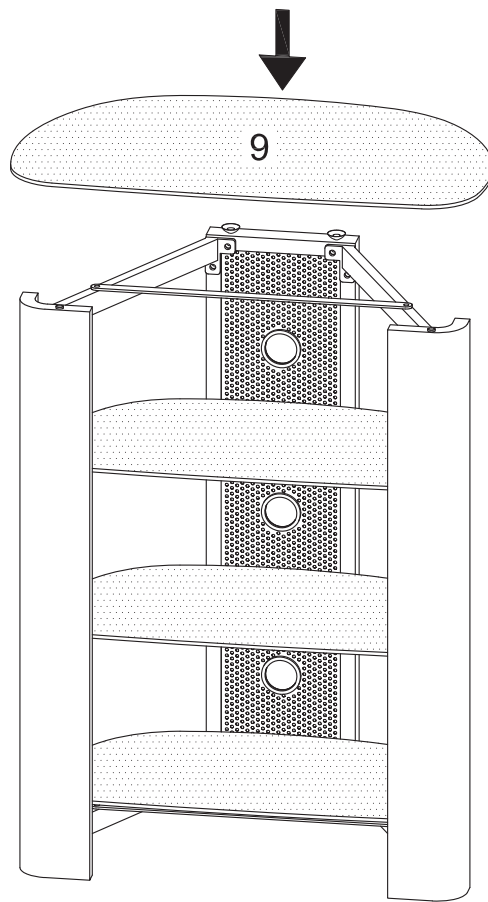

Place glass shelf (9) carefully on top of the stand and gently press down to secure.

## Step 8

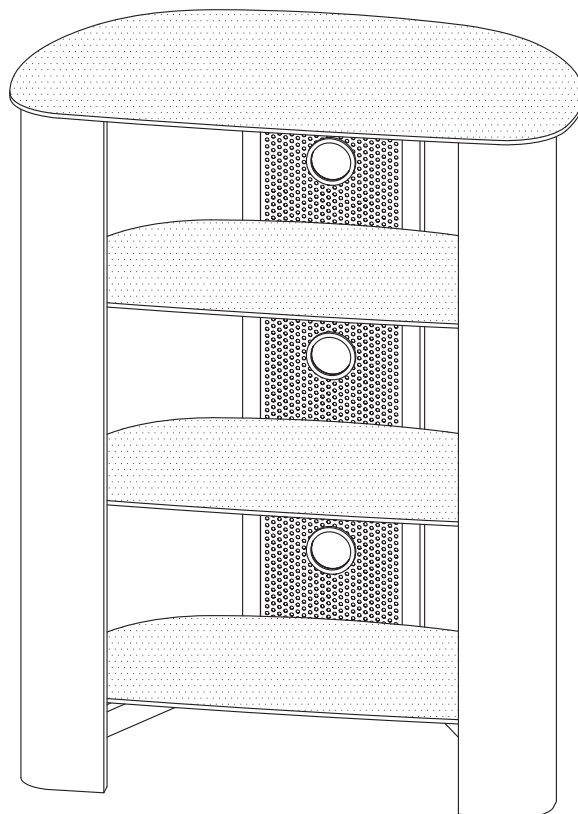

**Final Assembly**