

Limited Warranty

True Innovations seating products are warranted against defects in material and workmanship while owned by the "Original Purchaser". The term "Original Purchaser" is defined as that party or entity which purchases True Innovations furniture from an authorized True Innovations retailer as shown by the **original sales receipt**. This warranty does not apply to "as is" or previously owned seating products.

True Innovations warrants its products to be free from defects in materials and workmanship (normal wear and tear, fading and stretching excepted), for one year from the date of purchase, except as provided below under the limited warranty.

The exceptions or exclusions to this warranty are as follows:

1. Any warranty claim that is submitted after the limited warranty period, or without proper proof of purchase will not include the cost of parts, labor, or delivery.
2. This warranty shall not apply to the True Innovations products which have been subjected to misuse, neglect, alteration, modification, or attachments, either caused by the original purchaser, shipping, storage, accident, fire, flood, or acts of God.

In the event of a defect in material or workmanship covered by this warranty, True Innovations will repair or replace, at their discretion, without charge the warranted furniture within a reasonable amount of time. We reserve the right to require damaged parts to be returned to us upon request. Natural markings such as scars, brands, grain variations, wrinkles, color variations, etc. will be considered normal characteristics and not construed as defects. We cannot warrant leather against scratching or scuffing, as all leather is subject to blemishes with use.

For claims or questions concerning this warranty, please contact True Innovations Customer Service department on the web at www.truecustomersupport.com. Be prepared to provide your name, address, daytime phone number, the model and purchase order number of the product, date of purchase, and the store where it was purchased. True Innovations requires that the original sales receipt be submitted with all requests to confirm that you are the original purchaser according to our written warranty.

This warranty gives you specific rights, and you may also have other rights, which vary from state to state.

All warranties are limited to the original purchaser for normal use by a maximum of two users. Total weight capacity is 500 pounds or less for two users, or 250 pounds or less for a single user.

Should you prefer to speak with a service representative, you may call toll free: 1-855-372-2315.

78 inch EZ No Tools Fabric KD Sofa Assembly Instructions Model CR-43538PB / CR-43539PB

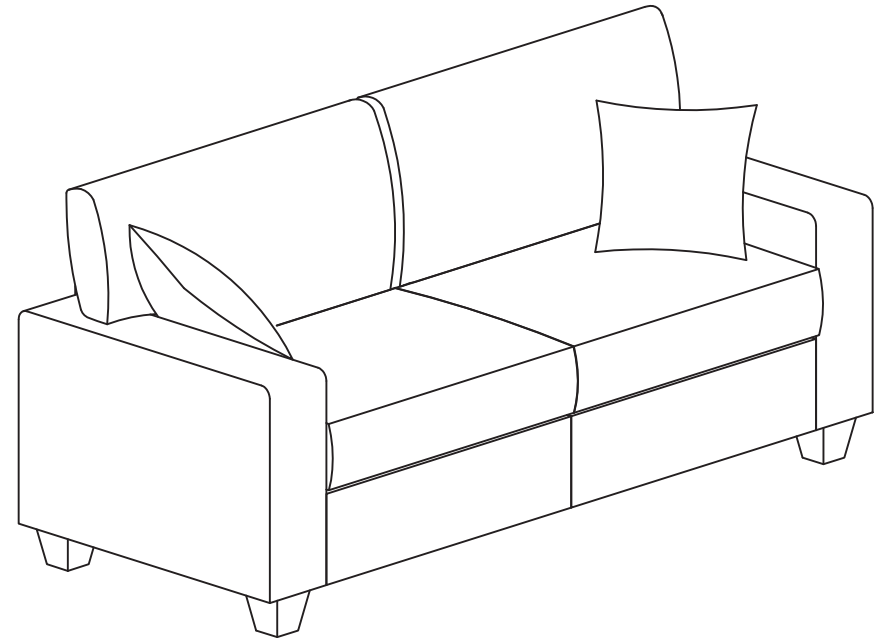

THIS INSTRUCTION BOOKLET CONTAINS IMPORTANT SAFETY INFORMATION.
PLEASE READ AND KEEP FOR FUTURE REFERENCE.

Customer Service: 1-855-372-2315



Thank you for selecting one of True Innovations seating solutions.

It's True...Fast, Friendly Customer Service

At True Innovations, we are committed to excellence. Our primary objective is to provide fast, friendly customer service to all of our customers.

We are here to help if you have any questions, comments, or are in need of warranty replacement parts.

Please call us toll free at: **1-855-372-2315**
 (Monday - Friday 6:00am - 5:00pm P.S.T)
 or visit website:
www.truecustomersupport.com

Step 6 --

Open the vacuum packed Seat Cushions (F) by carefully cutting the bags with a pair of scissors. Fluff all cushions and pillows to allow them to expand. Insert the Back Cushions (H) into the appropriate Back Covers (I). Insert the Seat Cushions (F) into the appropriate Seat Covers (G). Remember to keep the top side of the Seat Cushions (F) with the top side of the Seat Covers (G). Lastly, position all cushions and pillows on the sofa.

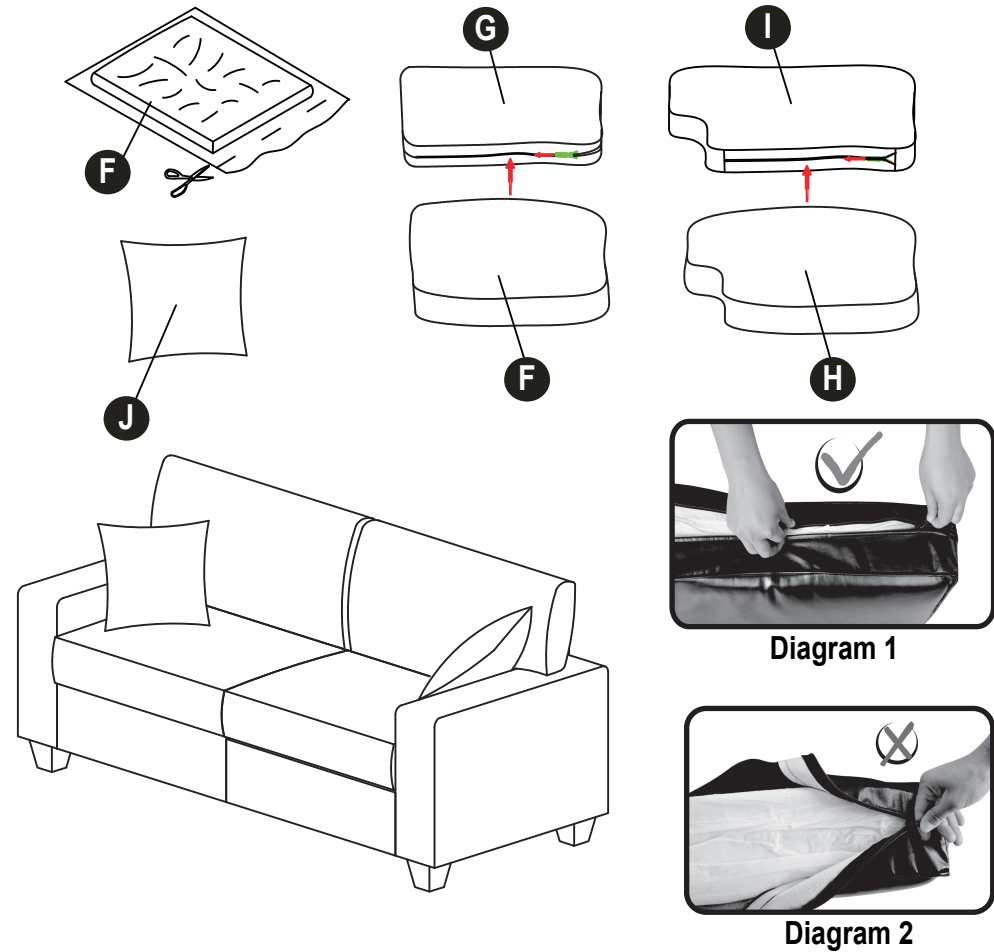

ATTENTION: To close the zipper, please follow diagram 1. Failure to follow this could result in damage to the zipper.

- Step 5 --** Secure the bottom and back flaps with hook and loop tape. Remove the plastic caps on the threaded bolts of each leg. Attach the 2 Wood Legs with Washers and Covers (C) to the middle holes of the sofa (Ensure the plastic spacer is in place). Attach the Wood Legs (B) to the corners of the sofa.

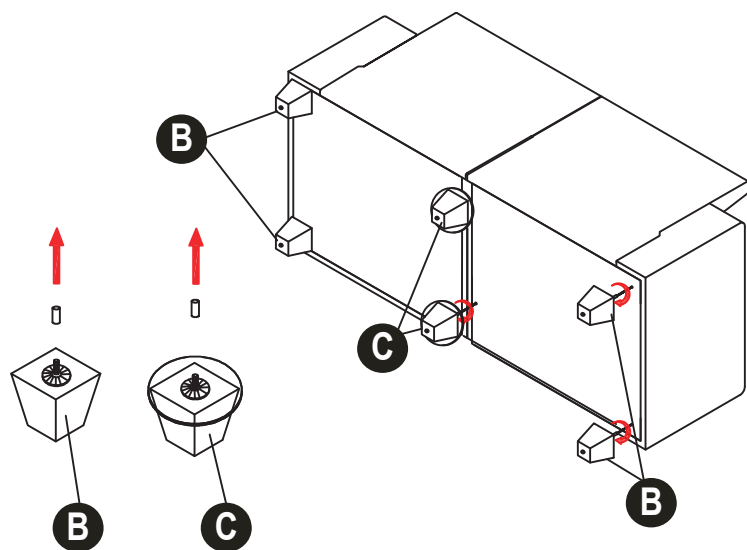
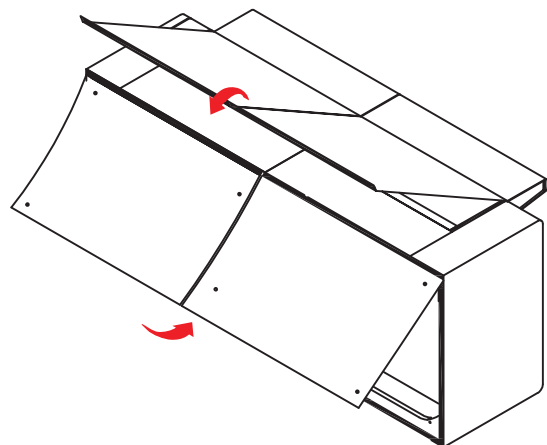

NOTES:

- Please read the instruction sheets completely before assembly.
- Remove all parts from carton and ensure all parts are included prior to assembly.
- Assemble the sofa on a protected surface to avoid scratching the components of sofa.
- Be careful not to cross-thread screws.
- Do not use power tools.
- Two people are recommended for assembly!
- Seat and back cushions may take 24-48 hours to fully expand, which will allow wrinkles caused by packing to fade.

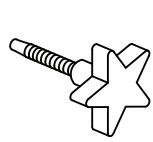

A Thumb Bolts (5)

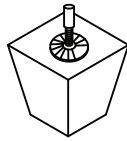

B Wood Legs with Washers (4)

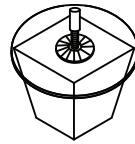

C Wood Legs with Washers and Covers (2)

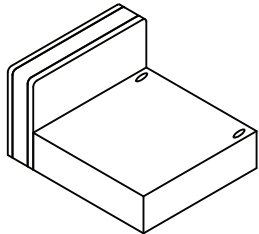

D1 Arm and Seat Frame with "L" Label (1)

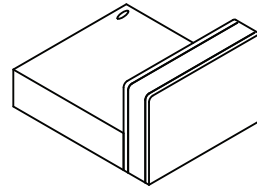

D2 Arm and Seat Frame with "R" Label (1)

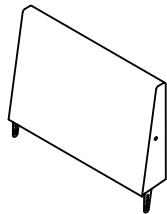

E1 Back Frame with "L" Label (1)

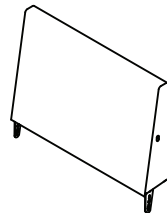

E2 Back Frame with "R" Label (1)

Step 4 -- Move the two assembled parts together. Align the holes of Seat Frames (D) and Back Frames (E) to the other side and secure with three Thumb Bolts (A). Ensure all Thumb Bolts (A) are completely tightened.

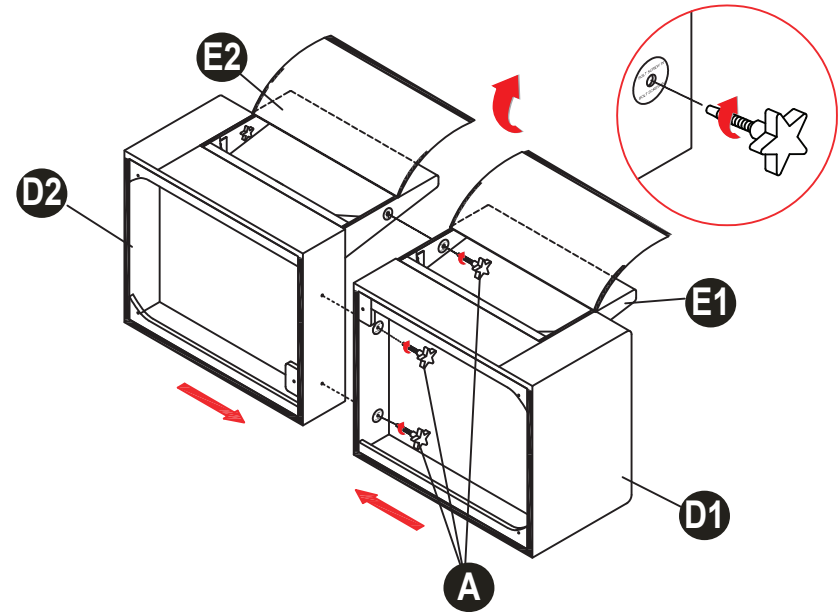

Step 3 -- Turn over the Arm and Seat Frame with "L" Label (D1) and slide the Back Frame with "L" Label (E1) into the seat frame until fully engaged. Align the holes of the Back Frame (E1) to the Arm Frame (D1) and secure with one Thumb Bolt (A).

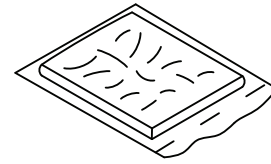
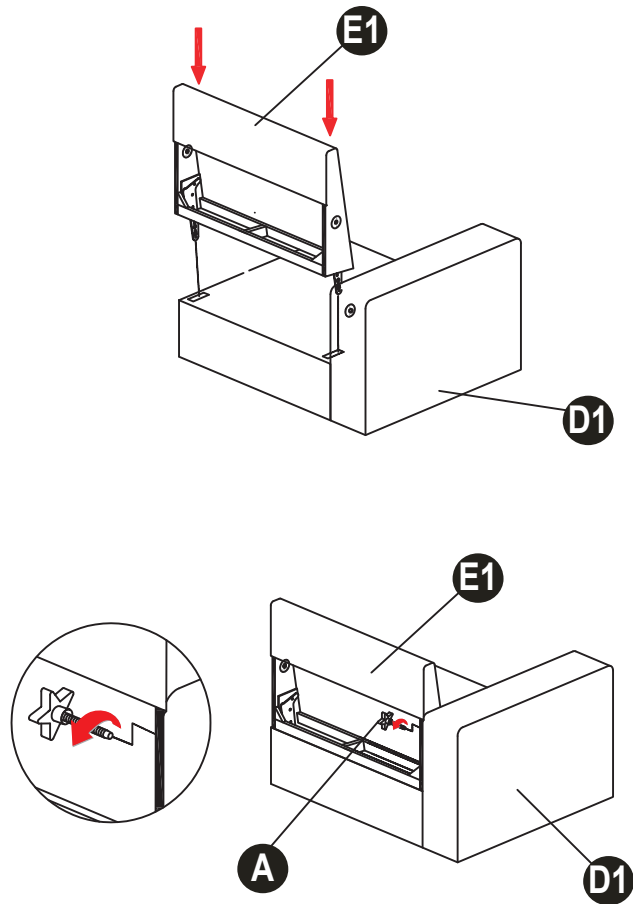

F Seat Cushions (Left & Right) (2)



G Seat Covers (Left & Right) (2)

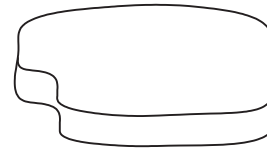

H Back Cushions (Left & Right) (2)

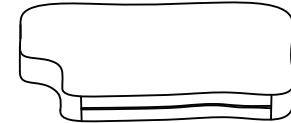

I Back Covers (Left & Right) (2)

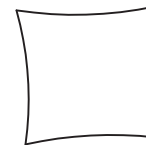

J Throw Pillows (2)



Step 1 -- Remove all parts from the carton and place them on a protected surface or carpet. Place the Arm and Seat Frames (D) upside down and open the bottom flap. Take the Back Cushions (H), Wood Legs (B), Wood Legs with Washer and Covers (C), Back Frames (E) and Thumb Bolts (A) out of the seat box.

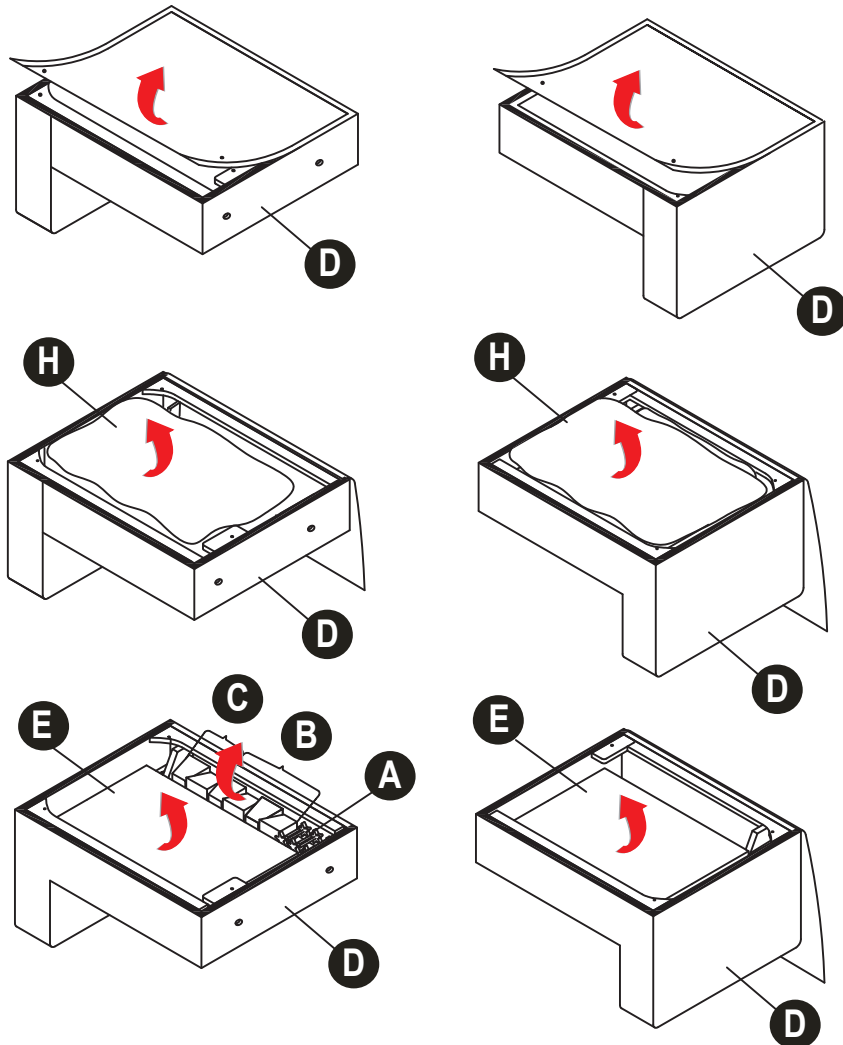

Step 2 -- Turn over the Arm and Seat Frame with "R" Label (D2) and slide the Back Frame with "R" Label (E2) into the seat frame until fully engaged. Align the holes of the Back Frame (E2) to the Arm Frame (D2) and secure with one Thumb Bolt (A).

