

4" KISS CANOPY LED PENDANTS

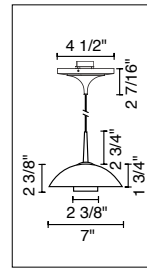

JAS
222 912(bz,mc)/am/MP
222 912(bz,mc)/bl/MP
222 912(bz,mc)/wh/MP

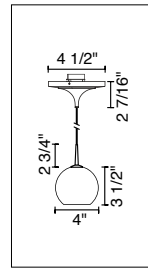

BOBO
222 909(bz,ch,mc)/MP
222 915(bz,ch,mc)/MP
222 917(bz,ch,mc)/MP

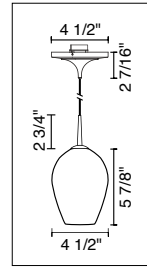

BOLERO
222 336(bz,ch,mc)/MP
222 337(bz,ch,mc)/MP
222 338(bz,ch,mc)/MP
222 339(bz,ch,mc)/MP

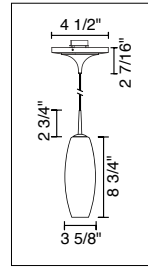

CIRO
222 116(bz,ch,mc)/MP
222 119(bz,ch,mc)/MP
222 121(bz,ch,mc)/MP
222 122(bz,ch,mc)/MP
222 123(bz,ch,mc)/MP
222 124(bz,ch,mc)/MP
222 125(bz,ch,mc)/MP

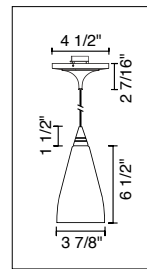

ZARA
222 151(bz,ch,mc)/MP
222 152(bz,ch,mc)/MP
222 154(bz,ch,mc)/MP
222 156(bz,ch,mc)/MP
222 157(bz,ch,mc)/MP

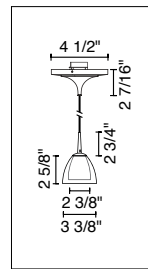

RAINBOW I
222 719(bz,ch,mc)/MP
222 721(bz,ch,mc)/MP
222 722(bz,ch,mc)/MP
222 723(bz,ch,mc)/MP
222 724(bz,ch,mc)/MP
222 913(bz,ch,mc)/MP
222 918(bz,ch,mc)/MP

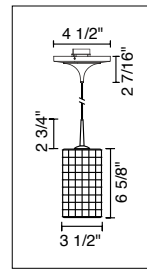

SIERRA
222 114bz/MP
222 114ch/MP
222 114mc/MP

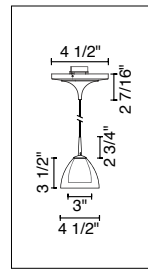

RAINBOW II
222 725(bz,ch,mc)/MP
222 726(bz,ch,mc)/MP
222 727(bz,ch,mc)/MP
222 728(bz,ch,mc)/MP
222 729(bz,ch,mc)/MP
222 816(bz,ch,mc)/MP
222 817(bz,ch,mc)/MP
222 916(bz,ch,mc)/MP
222 919(bz,ch,mc)/MP

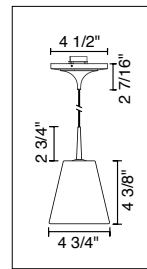

BLING I
222 168(bz,ch,mc)/MP
222 173(bz,ch,mc)/MP
222 178(bz,ch,mc)/MP
222 840(bz,ch,mc)/MP
222 841(bz,ch,mc)/MP
222 842(bz,ch,mc)/MP

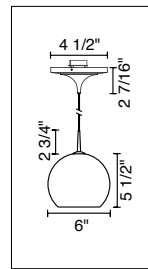

ZON
222 801bz/MP
222 801ch/MP
222 801mc/MP

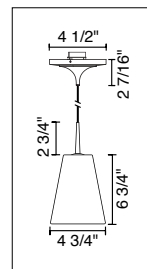

BLING II
222 169(bz,ch,mc)/MP
222 174(bz,ch,mc)/MP
222 179(bz,ch,mc)/MP
222 843(bz,ch,mc)/MP
222 844(bz,ch,mc)/MP
222 845(bz,ch,mc)/MP

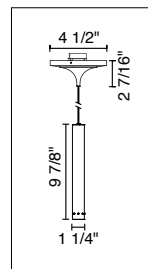

KEPLER
135 850ch/m/MP
135 850mc/m/MP
135 850-lch/m/MP
135 850-lmc/m/MP

4" KISS CANOPY LED PENDANTS

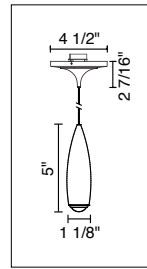

HAVANA
135 721al/MP
135 721ch/MP
135 721-lal/MP
135 721-lch/MP

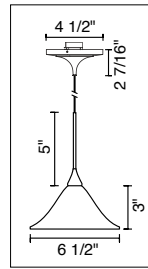

BELLA
222 091(bz,ch,mc)/MP
222 092(bz,ch,mc)/MP
222 094(bz,ch,mc)/MP
222 096(bz,ch,mc)/MP
222 099(bz,ch,mc)/MP

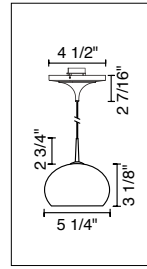

LAGUNA
222 810(bz,ch,mc)/MP
222 811(bz,ch,mc)/MP
222 812(bz,ch,mc)/MP
222 813(bz,ch,mc)/MP
222 814(bz,ch,mc)/MP
222 815(bz,ch,mc)/MP

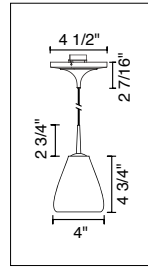

LUCY
222 126(bz,ch,mc)/MP
222 127(bz,ch,mc)/MP
222 128(bz,ch,mc)/MP

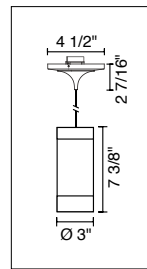

SILVA
222 711(bz,ch,mc)/MP
222 712(bz,ch,mc)/MP
222 713(bz,ch,mc)/MP
222 714(bz,ch,mc)/MP
222 715(bz,ch,mc)/MP
222 716(bz,ch,mc)/MP

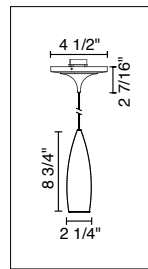

HAVANA II
135 700ch/MP
135 700mc/MP

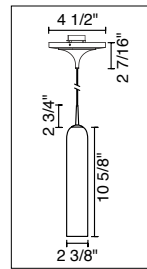

CHIANTI
222 820(bz,ch,mc)/MP
222 821(bz,ch,mc)/MP
222 822(bz,ch,mc)/MP
222 823(bz,ch,mc)/MP

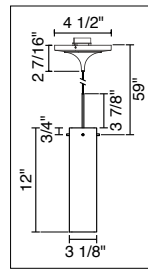

HOUSTON
222 850(bz,ch,mc)/MP
222 851(bz,ch,mc)/MP
222 852(bz,ch,mc)/MP
222 853(bz,ch,mc)/MP

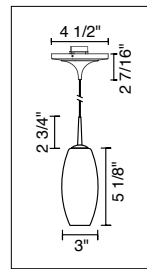

MINI CIRO
222 830(bz,ch,mc)/MP
222 831(bz,ch,mc)/MP
222 832(bz,ch,mc)/MP
222 833(bz,ch,mc)/MP

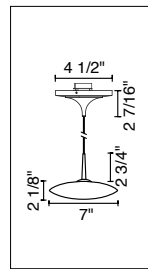

POISE
222 297bz/MP
222 297ch/MP
222 297mc/MP

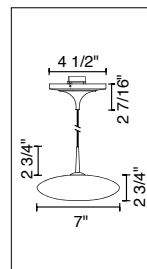

MYSTIQUE
222 190(bz,ch,mc)/MP
222 191(bz,ch,mc)/MP

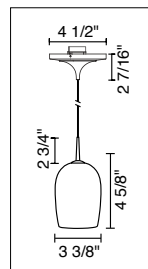

QUEENY
222 321(bz,ch,mc)/MP
222 322(bz,ch,mc)/MP
222 323(bz,ch,mc)/MP
222 324(bz,ch,mc)/MP
222 325(bz,ch,mc)/MP
222 370(bz,ch,mc)/MP
222 371(bz,ch,mc)/MP
222 372(bz,ch,mc)/MP
222 373(bz,ch,mc)/MP

4" KISS CANOPY LED PENDANTS

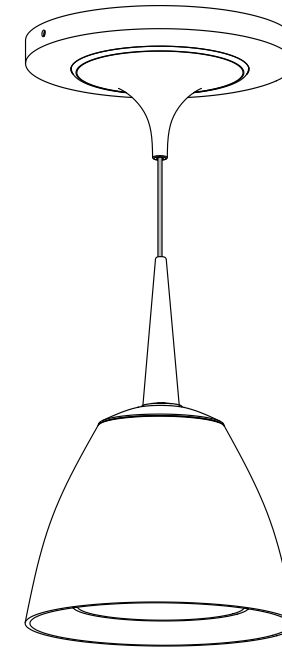

TECHNICAL SPECIFICATIONS

Description: Kiss pendant fixture with canopy and 75 Watt transformer
Design: Bruck-Team
Lamp: 3 Watt LED

CONTENTS OF DELIVERY

canopy and fixture complete



IMPORTANT SAFETY INSTRUCTIONS



- Save these instructions and refer to them when additions to or changes to the fixture are made.
- THIS PRODUCT MUST BE INSTALLED BY A PERSON FAMILIAR WITH THE CONSTRUCTION AND OPERATION OF THE PRODUCT AND THE HAZARDS INVOLVED, IN ACCORDANCE WITH THE APPLICABLE NEC CODE.
- Do not install this fixture in damp or wet locations.
- CAUTION - Do not install any fixture assembly closer than 6 inches from any curtain, or similar combustible material.
- Turn off power prior to any work on the systems.
- Warranty is void in case of unauthorized modifications and/ or improper use.

READ ALL OF THESE INSTRUCTIONS BEFORE INSTALLATION

INSTALLATION INSTRUCTIONS

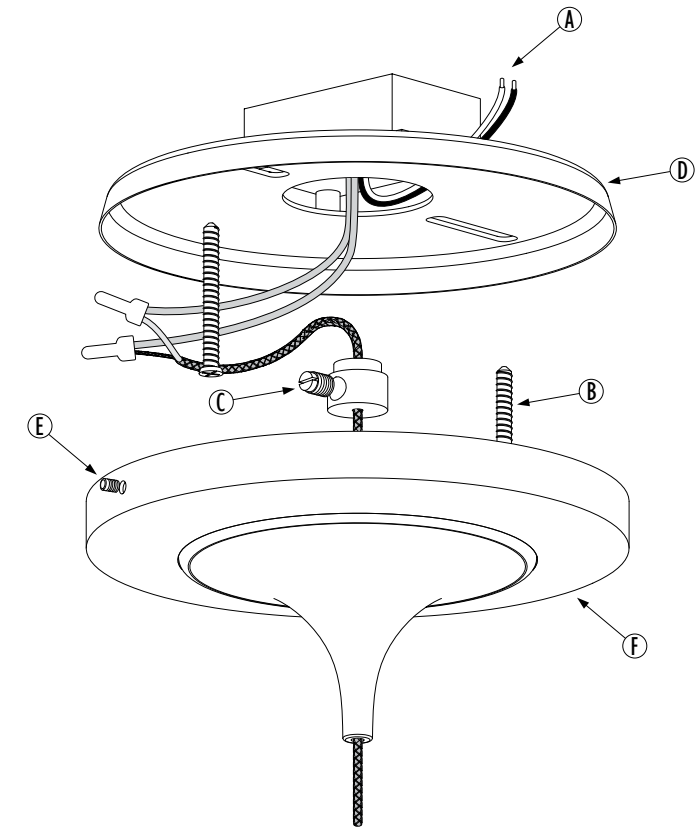

INSTRUCTIONS FOR USE

- Connect the two wires from the transformer (A) to the power cables in the wall.
- Align the screws (B) with the J-box and tighten until firmly connected. Adjust the cable length by loosening the center cable lock (C) and coiling excess cable around the canopy.
- Place the canopy cover (F) over the mounting plate (D) and secure it with the allen screw (E) located on the side of the base.