

4 DC

METAL RETRO ROUND TABLE (Yellow Original)

MODEL: 71120

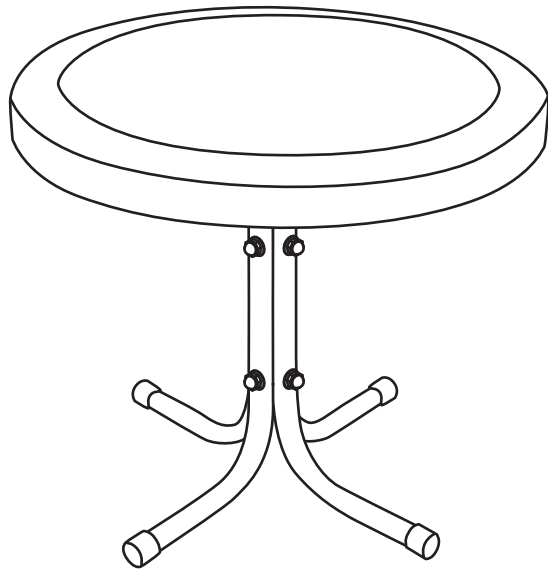

Dimensions: 22"(Dia.) x 19.5"(H)

NEED ASSISTANCE ?

Call 4D CONCEPTS directly for parts or assembly assistance.

Individual stores do not stock parts

Call our Toll-free number 5 days a week except holidays:

Monday through Friday 8.00am to 5.00pm

Pacific Standard Time

1-888-310-4DCO or 1-888-310 4326

IMPORTANT: Before calling please have the model number and the packing code number ready for our customer service representatives.

You will find the model number printed on the carton label and the packing code printed in black ink on the side of the carton.

Model 71120 Packing code

It is important that you retain the model number and the packing code along with the original receipt of purchase for future reference.

Made in China

71120 ASSEMBLY INSTRUCTION

PARTS LIST:

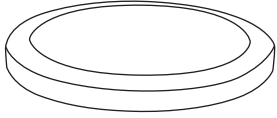
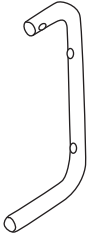

(A) Table Top Qty: 1	(B) Leg Qty: 4
	

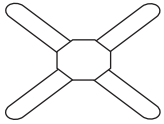
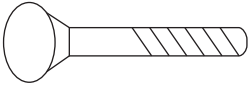
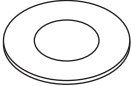
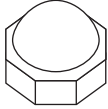
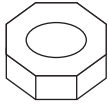
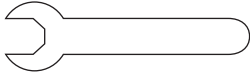
HARDWARE LIST:

1. Cross shape bolt Qty: 2	2. Screw 6 x 40 mm Qty: 4	3. Washer Qty: 12
		
4. Round top nut Qty: 8	5. Nut Qty: 4	6. Spanner Qty: 1
		

ATTENTION : DO NOT TIGHTEN ALL OF THE NUTS UNTIL THE FINAL STEP IS COMPLETED. IMPORTANT TO FULLY TIGHTEN BEFORE USING THE TABLE.

Step 1

Item	Drawing	Qty
1		2
3		4
4		4

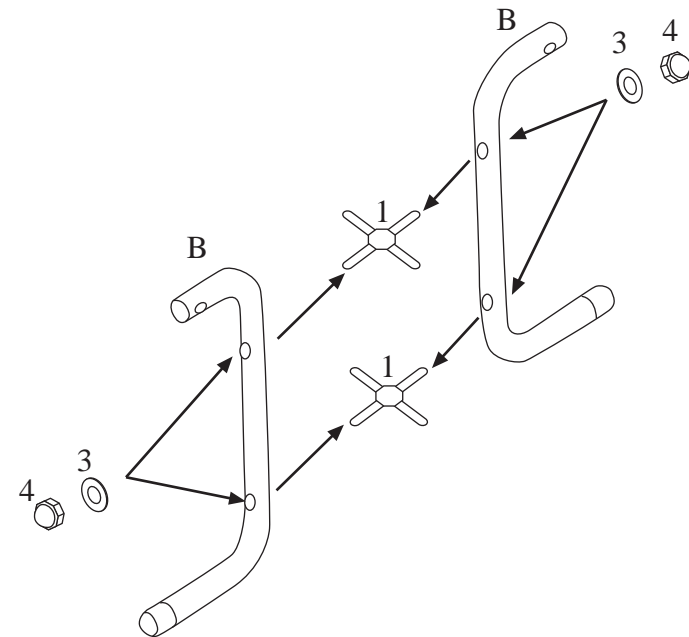



Attach each leg (B) to cross shaped bolt (1) with washer (3) & round top nut (4). Assemble as shown.

Hint: Assemble opposite legs to the cross shaped bolt (1). Then attach the remaining legs (B).

ATTENTION : DO NOT TIGHTEN ALL OF THE NUTS UNTIL THE FINAL STEP IS COMPLETED. IMPORTANT TO FULLY TIGHTEN BEFORE USING THE TABLE.

Step 2

Item	Drawing	Qty
3		4
4		4

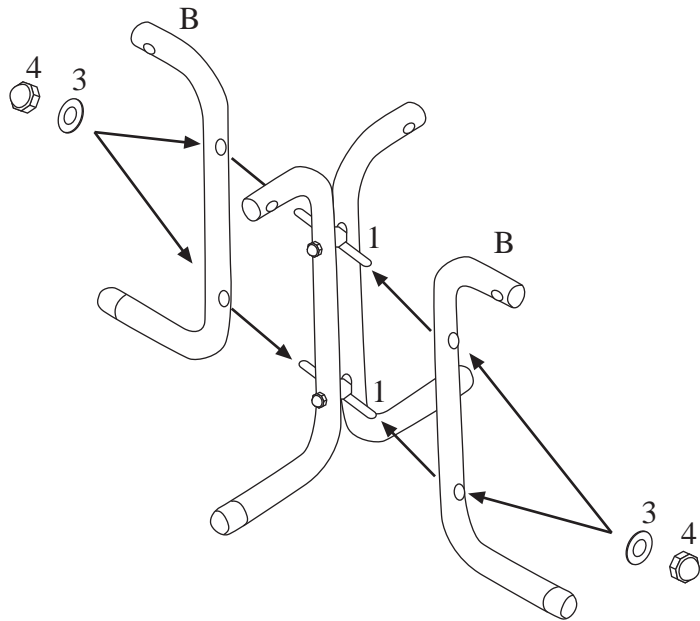



Attach each leg to cross shaped bolt (1) with washer (3) & round top nut (4). Assemble as shown.

IMPORTANT:

Exposure to harsh weather conditions may encourage rusting of the steel metal components. Protection from these conditions is recommended.

Step 3

Item	Drawing	Qty
2		4
3		4
5		4

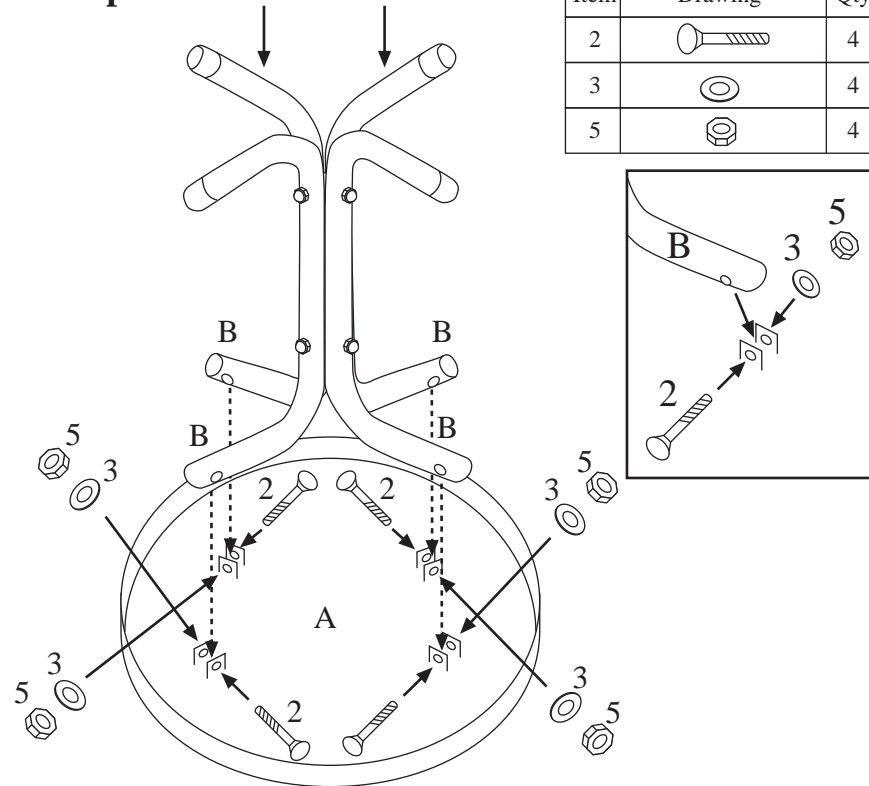

Put the table top (A) on the leg assembly (B) and then fix it with screw (2), washer (3) & nut (5). Assemble as shown.