

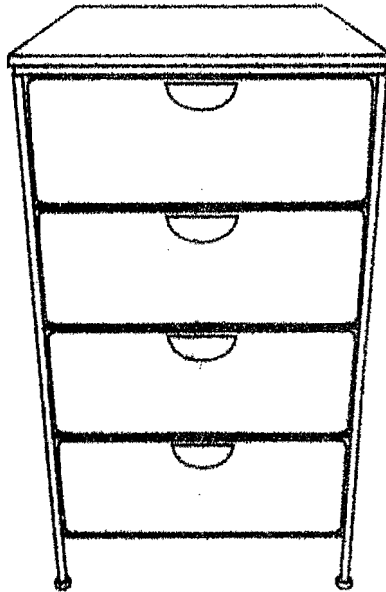

4D CONCEPTS
WICKER AND METAL
AUTUMN 4 DRAWER CHEST
263070



NEED ASSISTANCE ?

Call 4 D CONCEPTS directly for parts or assemble assistance

Individual stores do not stock part

Call our Toll-free number Five days a week, except holidays:

Monday through Friday 8:00am to 5:00pm

West Coast Time

1 - 888 - 310 - 4326

Important : Before calling for assistance, please have the Model number, Part number, and Packing code ready for one of our Customer Service Representatives. You will find the model number and part number on the first pages of the instruction sheet. You will find the packing code jet printed or stamped on the long side of the carton.

MODEL # : 263070

PACKING CODE # : _____

It's important that you retain the model number and the packing code along with the original receipt of purchase for future reference.

A)	B)	C)	D)	E)	F)	G)	H)	I)	J)
Drawer 4pcs	Stand-Left 1pc	Stand-Right 1pc	Bottle Frame 1pc	Middle Frame 3pcs	Supporter 2pcs	Top 1 pc	Ø5 x 23mm Screws 4 pcs	Ø5 x 10mm Screws 4 pcs	Ø5 x 10mm Screws+Nuts 4 sets

STEP 1

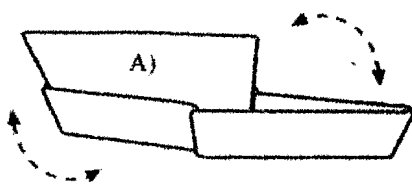

STEP 2

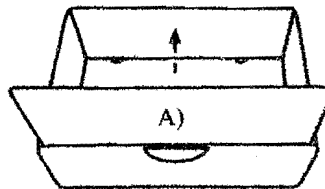

STEP 3

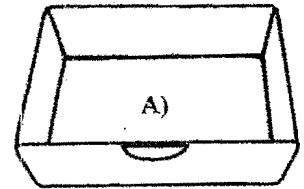

STEP 4

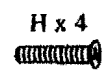
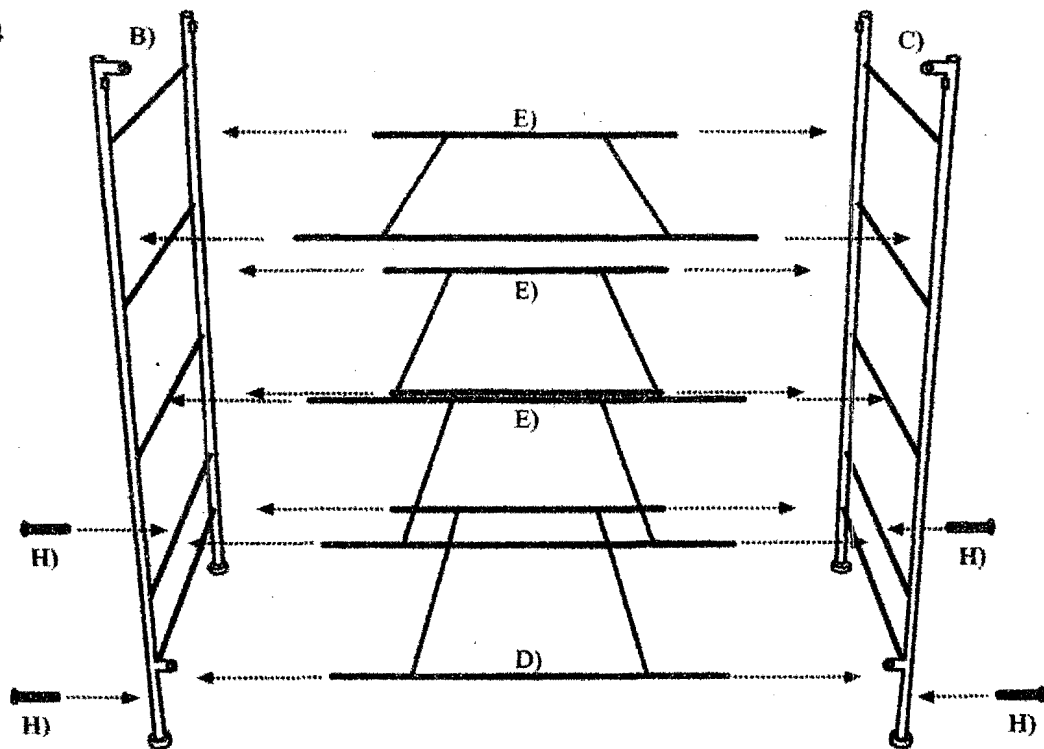

STEP 5

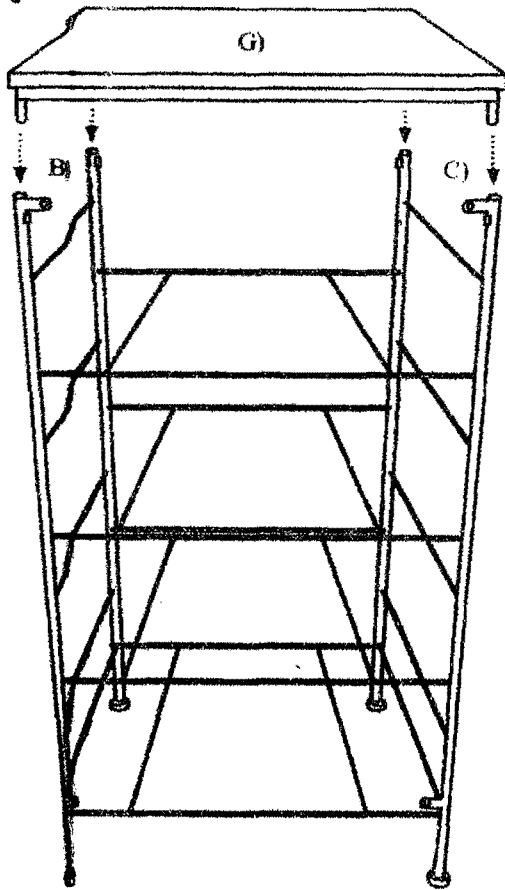

STEP 6

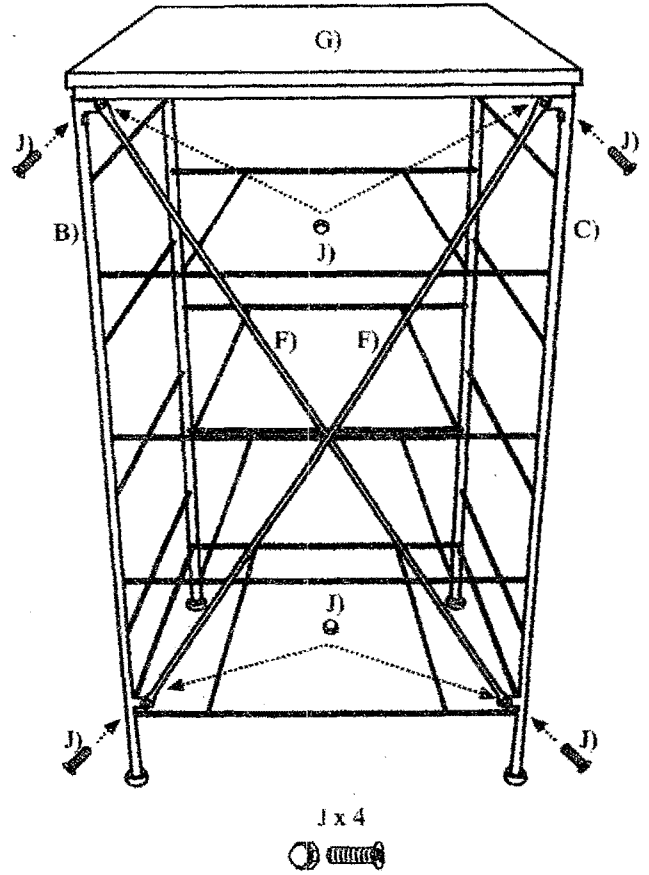

STEP 7

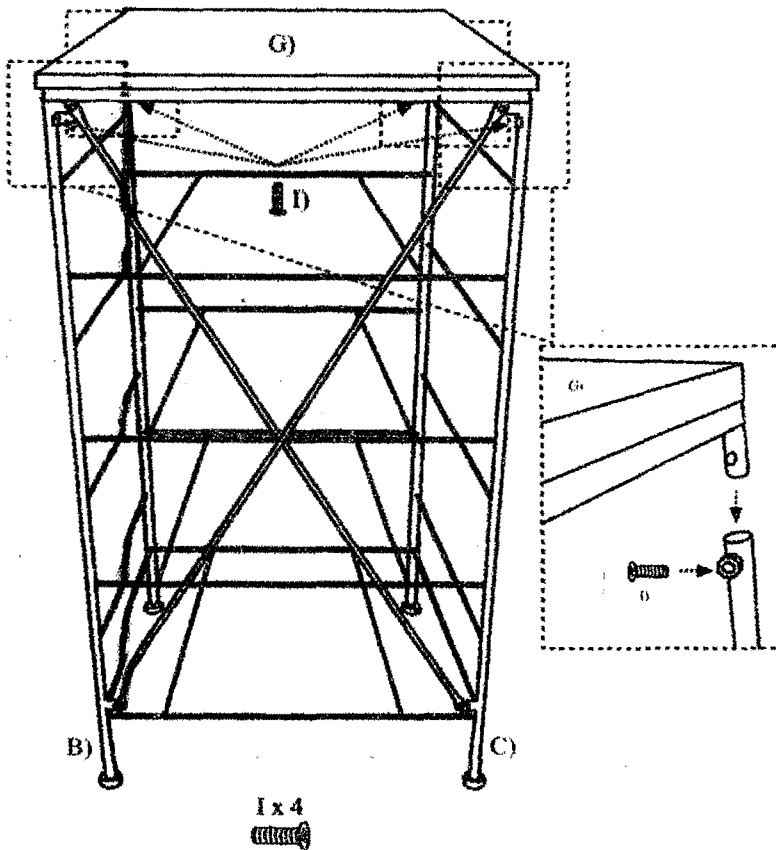

STEP 8

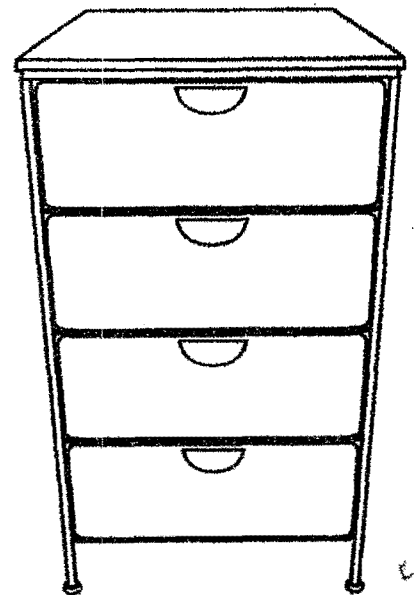

** BE SURE ALL ARE FULLY TIGHTENED BEFORE USE.