

### Table of Contents

Installing Vanities.....	1
Installing Vanity Top.....	1
Removing and Installing Doors .....	2
Adjusting Door Face Alignment .....	3
Removing and Re-installing Drawers.....	4
Adjusting Drawer Faces .....	4
Cleaning .....	6



If you have questions, don't hesitate to call our Customer Service  
Toll Free 1-800-445-0494, 7AM-4PM Pacific Coast Time.

Thank you for purchasing Strasser Woodenworks Products for your bath.

Crafted in USA to Last a Lifetime



## **CAUTION!** Remove Doors and Drawers

**Always** remove drawers and doors from your cabinets during installation (see pages 3 and 5) and store them away from the work area. This will make your cabinets lighter, easier to move and position, and safer to handle. Drawers and doors open unexpectedly and unbalance the cabinet while you are moving it, causing personal injury or damage to your cabinet. Plus, drawer and door faces will be protected from damage during installation if stored away from your project.

Damage caused during installation is not covered by warranty.

## Installing Vanities

The key to a good installation of a vanity ensemble is to understand that walls and floors are never exactly level, plumb, or square.

Securing a vanity or ensemble to your walls is important. However, forcing a square cabinet to fit against not-so-square walls will distort the cabinet frame and cause drawer and door hardware to mis-align and bind. While our hardware is fully adjustable to compensate for this visually, the drawers may not open and close smoothly. **Never** close gaps by overly tightening the securing screws. **Always** use shims between the cabinet and wall and floor where gaps exist before tightening securing screws.

Place the vanity or ensemble into its exact final position and level.  Use shimming underneath where necessary.

We recommend screwing to wall studs in at least two positions along the back and one in the side, if the side is against a wall. Shim where necessary at securing points between wall and cabinet if the wall is not exactly straight or plumb.

## Installing Vanity Tops

Install faucet and drain according to manufacturers instructions into the countertop before installing the top onto the vanity. Set countertop onto the vanity and check for fit and clearance of faucets, drain and plumbing inside the vanity. Remove top.

Using clear bath caulking/adhesive place 1" long beads on the top edge of the vanity: one in the middle of the back and each side; and approximately every 12" along the front. Place the countertop on the vanity and position snugly against the wall and center left to right. Clean any excess caulking from the vanity side panels under the countertop edge. Then, run a bead of caulking along the back of the top at the wall to seal that contact.

Let the caulk set overnight and proceed to connect the water supply lines and drain. Make faucet spigot and handle adjustments, etc. Turn on the water supply and check for leaks at all fittings. Fill the basin with water and then drain while checking for leaks.

**IMPORTANT** Check inside and around the vanity on the floor for water from leaks the next day and also in about a week. A slow leak can accumulate water under the vanity and will cause damage to the vanity. Without follow up checks you may never notice this until there is a problem. Damage from leaks is not covered by the warranty.

## Re-install Doors and Drawers

Once your cabinets are in their final positions and secured, re-install and adjust doors and drawers according to directions on pages 2 - 4.

## Removing and Re-installing Doors with 6-way Adjustable Hinges

To remove doors, loosen screw indicated on both hinges of a door at least 2 full turns. Slide door outward as shown and disengage.

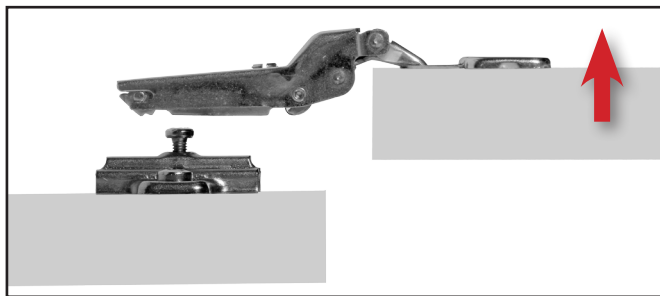
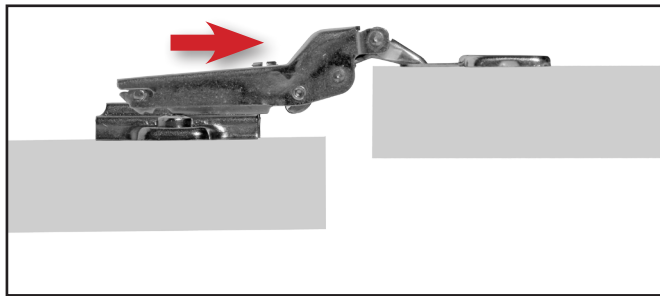
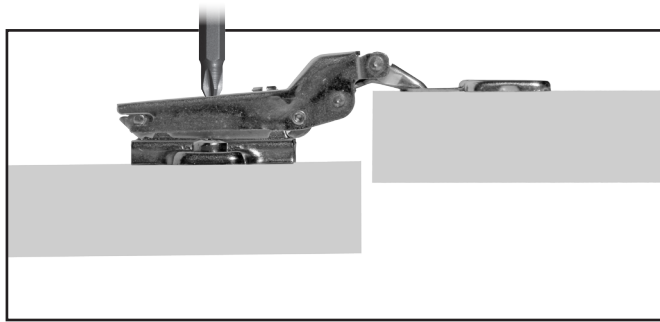

To re-install doors, simply reverse the removal process. Tighten screws part way, adjust door position, and tighten the screws securely.

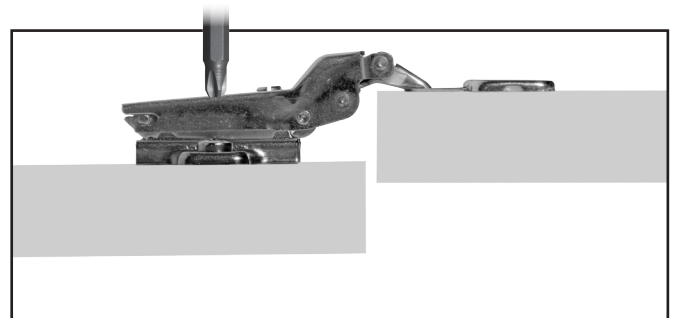
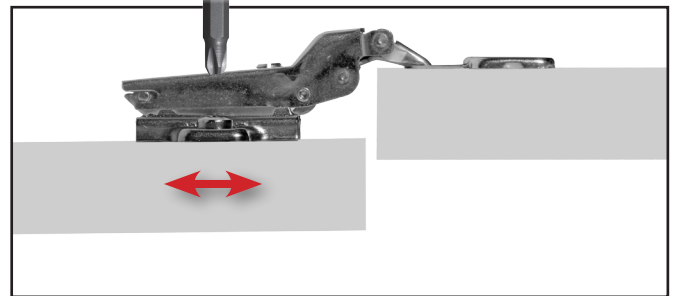
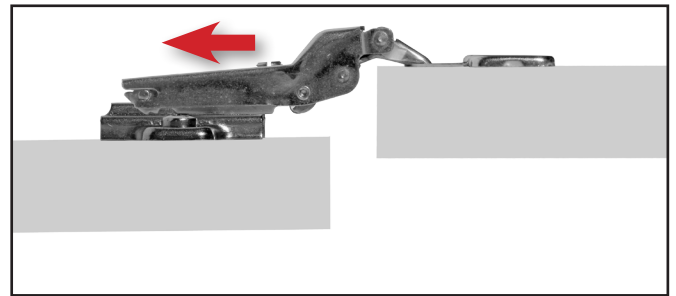
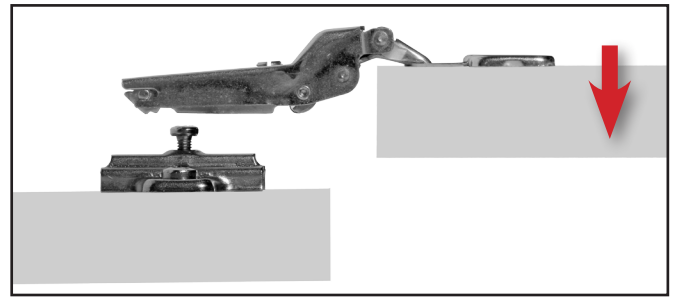

## Adjusting Door Face Alignment

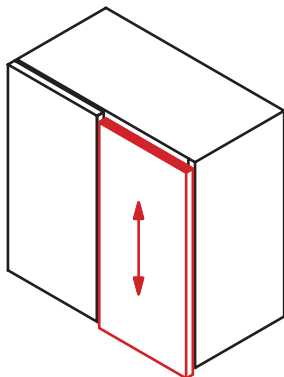

Adjusting door up & down

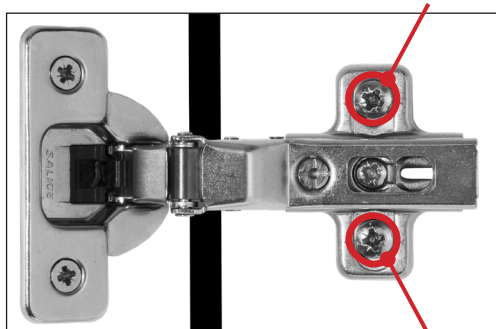

Loosen indicated screws on **both** hinges to adjust door up/down. **Never** adjust one hinge without also adjusting the other hinge.

Note: you may need to tap hinge hardware up or down as it may be stuck to cabinet finish initially.

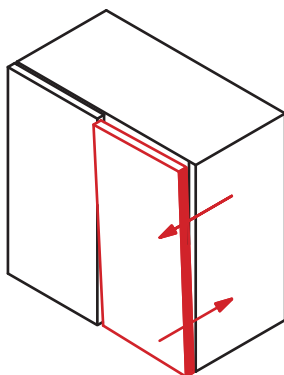

Adjusting door in & out

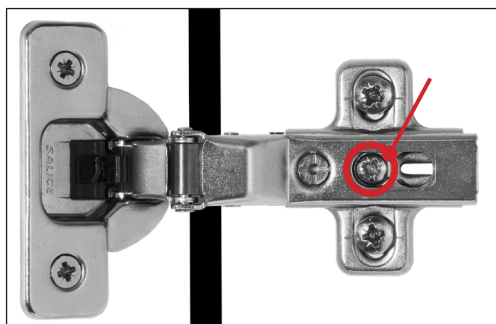

Loosen indicated screw  $\frac{1}{2}$  turn and adjust door in/out. Then tighten.

**Note:** as the door corner at the hinge moves in one direction, the diagonally opposite corner moves in the other direction.

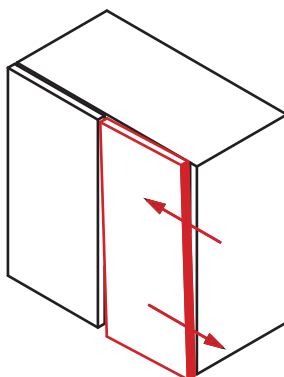
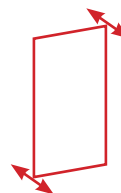

Adjusting door left & right

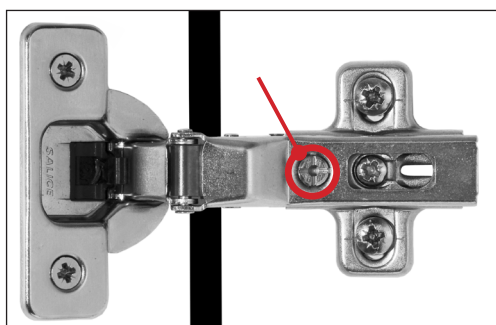

Simply turn indicated screw to adjust door left/right.

## Removing and Re-installing Drawers

To remove a drawer, simply open completely while lifting the drawer box to disengage the drawer box from the cabinet.

To re-install, align the nylon wheels and drawer guides and insert the drawer.

## Adjusting Drawer Face Alignment



To adjust drawer face alignment loosen the two drawer face adjusting screws inside the drawer box slightly and move the face to the desired position. Once you are satisfied, tighten all of these screws on all drawers.

Then, screw the provided set screws into the small holes beneath the adjusting screws to secure the faces to the drawer boxes.

## Cleaning

- **Always** use only a damp soft cloth to clean your bath cabinets.
- **Never** use abrasive cleansers on any part of your bath cabinets.
- **Never** use a scouring sponge.
- **Never** use bleach, solvents (like nail polish remover), or harsh cleaners on your cabinets.
- **Never** use cleaners containing abrasives (liquid or powder) to clean this vitreous china top. Doing so will damage the gloss finish.
- **Clean** the top frequently with a damp cloth or sponge with non-abrasive cleaners.
- **Do not** drop hard items onto the surface or into the basin. Vitreous china may chip when impacted.

If you have questions, don't hesitate to call our Customer Service  
Toll Free 1-800-445-0494, 7AM-4PM Pacific Coast Time.

Thank you for purchasing Strasser Woodenworks Products for your bath.

Crafted in USA. to Last a Lifetime

