

USER'S MANUAL

# LEVEL 1 FITNESS™

## 605 MAGNETIC BIKE

MODEL NUMBER: 99605

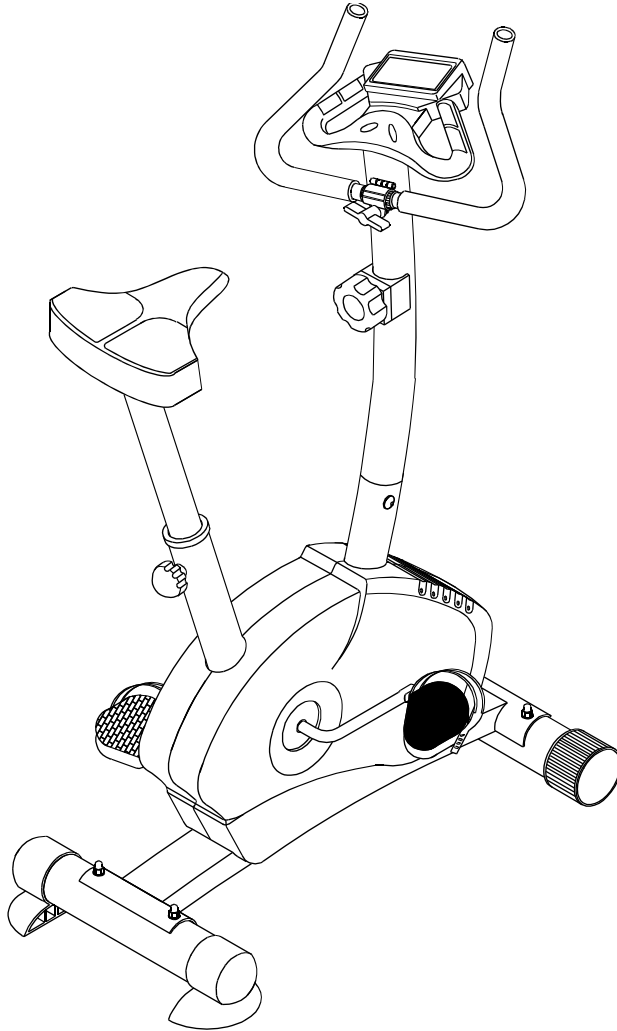

USER WEIGHT LIMITATION: **250lbs.**

TOLL FREE CUSTOMER SERVICE NUMBER: **1.888.535.8637**

SERIAL NUMBER (found on frame):

APPLICATION STANDARD



## PREASSEMBLY

### **Open the boxes:**

You are now ready to open the boxes of your new equipment. Make sure to inventory all of the parts that are included in the boxes. Check the Hardware Comparison Chart for a full count of the number of parts included for this product to be assembled properly. If you are missing any parts, please **DO NOT TAKE THE UNIT BACK TO THE RETAIL STORE**. Instead, call our Customer Service Department Monday through Friday, 8:00am until 4:00pm, Pacific time (excluding holidays) at: 1.888.535.8637

### **Gather your tools:**

Before starting the assembly of your unit, make sure that you have gathered all the necessary tools you may require to assemble the unit properly. Having all of the necessary equipment at hand will save time and make the assembly quick and hassle-free.

### **Clear your work area:**

Make sure that you have cleared away a large enough space to properly assemble the unit. Make sure the space is free from anything that may cause injury during assembly. After the unit is fully assembled, make sure there is a comfortable amount of free area around the unit for unobstructed operation.

### **Invite a friend:**

Some of the assembly steps may require heavy lifting. It is recommended that you obtain the assistance of another person when assembling this product.

### **User Weight Limitation:**

Please note that there is a weight limitation for this product. **If you weigh more than 250lbs. it is not recommended that you use this product. Serious injury may occur if the user's weight exceeds the limit shown here.** This product is not intended to support users whose weight exceeds this limit.

PRECAUTIONS**For future service or related questions:**

Please staple your receipt and/or write in the name and phone number of the retail store where you purchased your Level 1 Fitness Exercise Bicycle.

Name: \_\_\_\_\_ Phone Number: \_\_\_\_\_ Receipt: \_\_\_\_\_

**Precautions:**

**WARNING:** Read the owners manual and follow it carefully before using your Exercise Bicycle. This product is for in-home use only, not for commercial or rental use. It is the responsibility of the owner to ensure that all users of this bicycle are adequately informed of all warnings and precautions.

- Use the bicycle only as described in this manual. Read all warnings that are posted on the Exercise Bicycle.
- Place on a level surface, with 3 feet (1 m) of clearance all around the entire bicycle. To protect the floor or carpet from damage, place a mat under the bicycle.
- Inspect the Exercise Bicycle for worn or loose components prior to use. Tighten all bolts and components prior to use.
- Keep the bicycle indoors, away from moisture and dust. Do not put the bicycle in a garage or covered patio, or near water.
- Keep children and pets away from the bicycle at all times.
- The bicycle should not be used by persons weighing more than 250lbs.
- Wear appropriate exercise clothing when using the bicycle. Do not wear loose clothing that could become caught in the bicycle. Athletic support clothes are recommended for both men and women. Always wear athletic shoes. Never use the bicycle with bare feet, wearing only stockings, or in sandals.
- Always examine your bicycle before using to ensure all parts are in working order.
- Never insert any object or body parts into any opening.
- To move your Exercise Bicycle from one location to another, simply lift up on the rear of the seat and push forward. There are rolling casters provided on the front stabilizer that allow the bicycle to roll forward or backwards. The rear stabizier must be lifted off the ground to enable the casters to roll.

**HARDWARE COMPARISON CHART**

**Hardware chart:**

For your convenience, we have identified the hardware used in the assembly of this product. This chart is provided to help you identify those items that may be unfamiliar to you.

No.	Description	Qty.
7	Saddle post knob	1
18	Allen key wrench	1
19	Screw driver	1
20	Carriage bolt (for front & rear stabilizer)	4
21	Cap nut (for front & rear stabilizer)	4
22	Washer (for front & rear stabilizer & handlebar post)	4
31	Pedal (R & L)	2

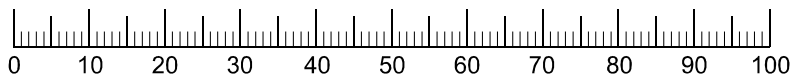
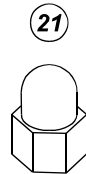
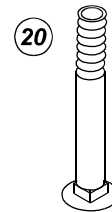
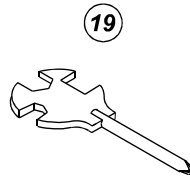
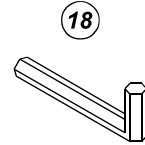
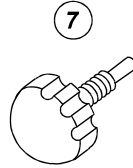

MILLIMETERS

**ASSEMBLY****STEP 1:**

Attach the front stabilizer (2) and the rear stabilizer (3) to the main frame (1) using 2 carriage bolts (20), 2 washers (22) and 2 cap nuts (21) for each as shown in FIG 1.

Screw the pedals (31) onto the crank set (32) as shown in FIG 2. The pedals are marked with R for RIGHT and L for LEFT at the screw. Tighten the left pedal counter-clockwise and the right pedal clockwise.

Connect the upper computer cable (12) with the cable at the back of the computer (16). Attach the computer (16) to the handlebar post (4) using 4 bolts (35) as shown in FIG 3.

FIG 1.

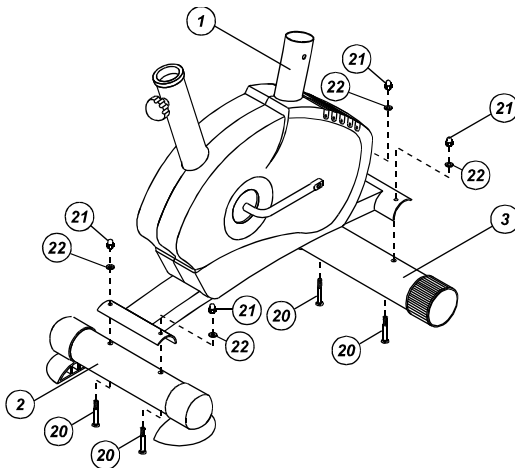

FIG 2.

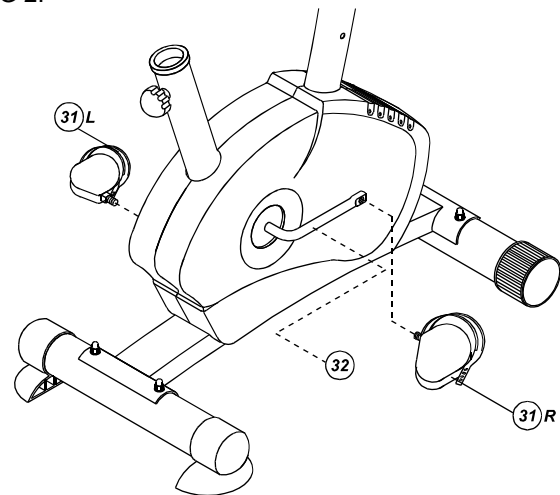
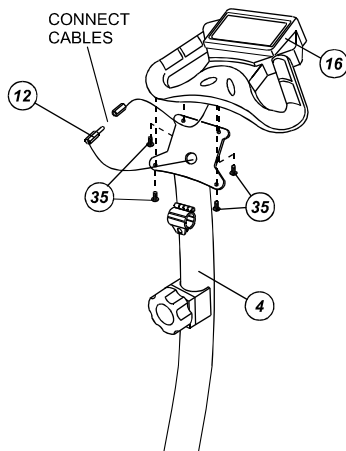

FIG 3.



**ASSEMBLY****STEP 2:**

Plug the upper computer cable (12) into the lower computer cable (13). Hook the stopper of the tension control (10) with the box of the tension control cable (11) securely. Unscrew the 4 pre-assembled hexagon bolts (23). Then insert the handlebar post (4) into the main frame (1) and secure using the 4 hexagon bolts (23) and washers (24) as shown in FIG 4.

Open the clamp located on the Handlebar Post (4), and insert the Handlebar (33). Close the clamp and secure with (36) and T-Knob (9) as shown in FIG 5. Ensure it is tightened very well.

FIG 4.

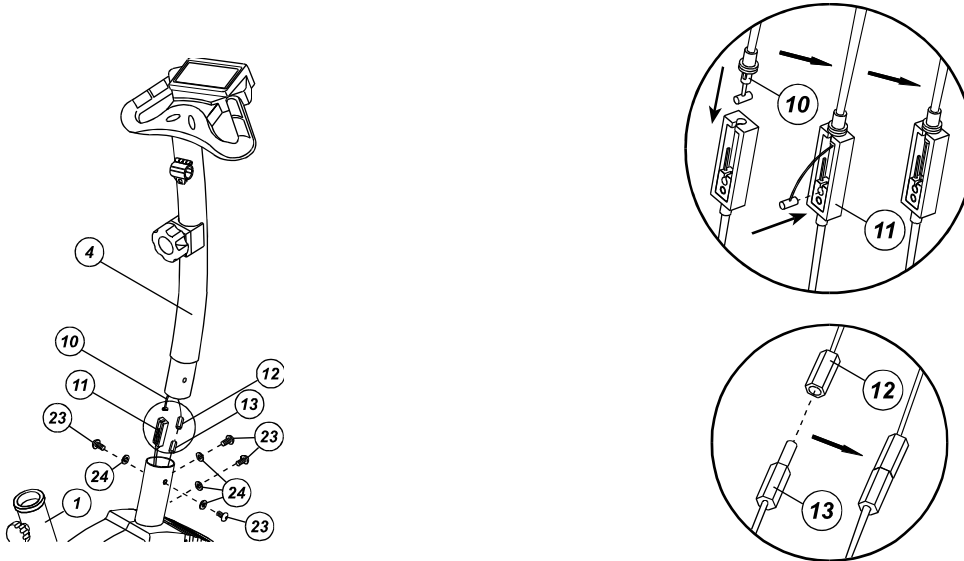
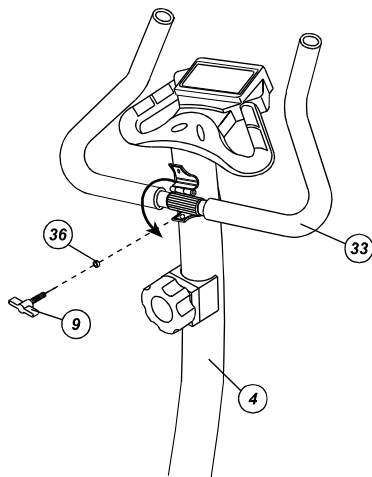

FIG 5.



**ASSEMBLY****STEP 3:**

Attach the saddle post (5) onto the saddle (6) using 3 washers (25) and 3 locknuts (26) as shown in FIG 6.

Slide the foam grips (34) onto each side of handlebar (33) as shown in FIG 7. A small amount of soapy water applied to the inside of the foam grips will make it easier. Cap the ends of the handlebar (33) with 2 end caps (17).

Loosen the saddle post knob (7). Insert the saddle post (5) into the main frame (1), choose the desired position and retighten the saddle post knob (7) as shown in FIG 8. Ensure that the knob is always firmly tightened before use.

FIG 6.

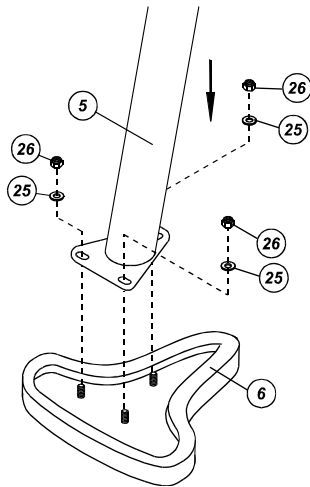

FIG 7.

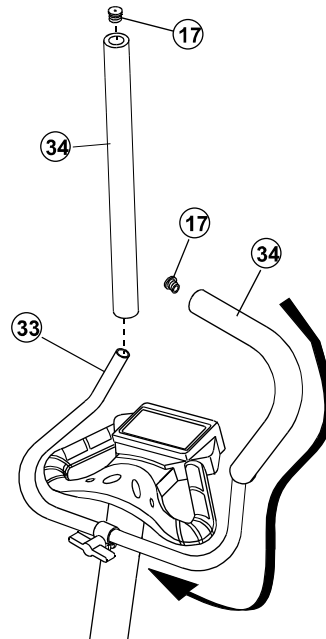
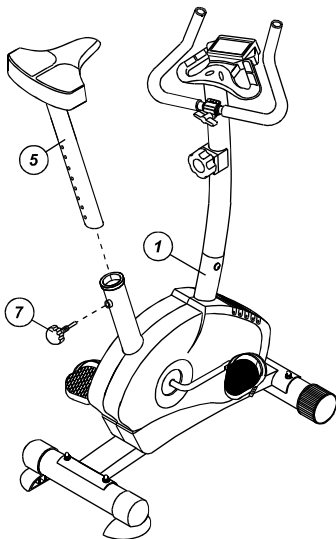
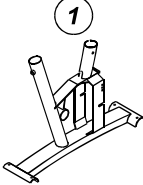
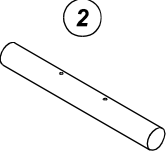
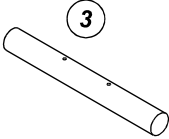
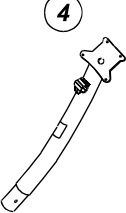

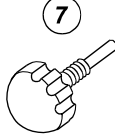
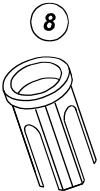
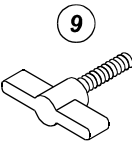
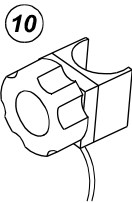
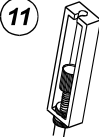
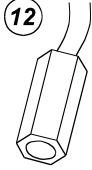
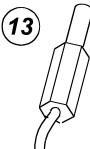
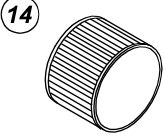
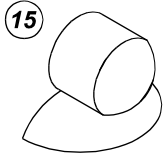
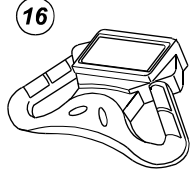

FIG 8.











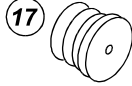
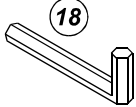
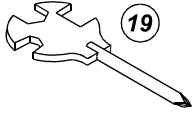
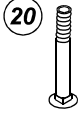
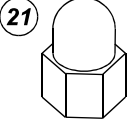
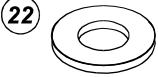
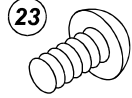
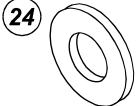
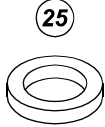

## PARTS LIST

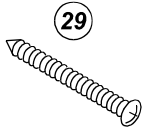
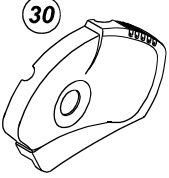
No.	Description	Qty.	Order Number	
1	Main frame	1	99605-01	
2	Front stabilizer	1	99605-02	
3	Rear stabilizer	1	99605-03	
4	Handlebar post	1	99605-04	
5	Saddle post	1	99605-05	
6	Saddle	1	99605-06	
7	Saddle post knob	1	99605-07	
8	Fastener (for saddle post)	1	99605-08	
9	T- knob (for handlebar)	1	99605-09	
10	Tension control	1	99605-10	
11	Tension control cable	1	99605-11	
12	Computer cable (upper)	1	99605-12	
13	Computer cable (lower)	1	99605-13	
14	Front stabilizer cap	2	99605-14	
15	Rear stabilizer cap	2	99605-15	
16	Computer	1	99605-16	

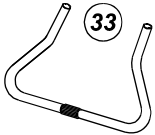
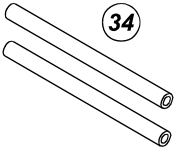

## PARTS LIST

No.	Description	Qty.	Order Number	
17	End caps (pair)	2	99605-17	
18	Allen key wrench	1	99605-18	
19	Screw driver	1	99605-19	
20	Carriage bolt (for front & rear stabilizer)	4	99605-20	
21	Cap nut (for front & rear stabilizer)	4	99605-21	
22	Washer (for front & rear stabilizer & handlebar post)	4	99605-22	
23	Hex. Bolt (for handlebar post)	4	99605-23	
24	Washer (for handlebar post)	4	99605-24	
25	Washer (for saddle )	3	99605-25	
26	Locknut (for saddle)	4	99605-26	
27	Bolt (for tension control)	1	99605-27	
28	Washer (for tension control)	1	99605-28	
29	Screw (for chain cover)	3	99605-29	
30	Chain cover (R & L)	1	99605-30	
31	Pedal (R & L)	1	99605-31	
32	Crank set	1	99605-32	
33	Handlebar	1	99605-33	
34	Foam grips (pair)	1	99605-34	
35	Bolt (for computer)	4	99605-35	
36	Washer (for T-knob)	1	99605-36	
37	Screws (for Main frame)	2	99605-67	

## LEVEL 1 FITNESS 605 MAGNETIC BIKE

PARTS LIST

<b>No.</b>	<b>Description</b>	<b>Qty.</b>	<b>Order Number</b>
A1001	Washer (for flywheel)	2	99605-A1001
A1002	Washer (for flywheel)	3	99605-A1002
A1003	Nut (for flywheel)	2	99605-A1003
A1004	Bolt (for idle wheel fixture)	1	99605-A1004
A1005	Bolt (for idle wheel fixture)	1	99605-A1005
A1006	Nut (for idle wheel)	1	99605-A1006
A1007	Steel sleeve	1	99605-A1007
A1008	Screw (for sensor)	1	99605-A1008
B2001	Flywheel set	1	99605-B2001
B2002	Belt wheel	1	99605-B2002
B2003	Idle wheel	1	99605-B2003
C3001	Ball bearing set	1 set	99605-C3001
C3002	Spring	1	99605-C3002
D4001	Poly-v belt	1	99605-D4001
D4002	Sensor	1	99605-D4002
D4003	Magnet	1	99605-D4003
D4004	Idle wheel fixture	1	99605-D4004

PARTS DIAGRAM

A MAJORITY OF THE PARTS SHOWN HERE HAVE BEEN PREASSEMBLED AT THE FACTORY.

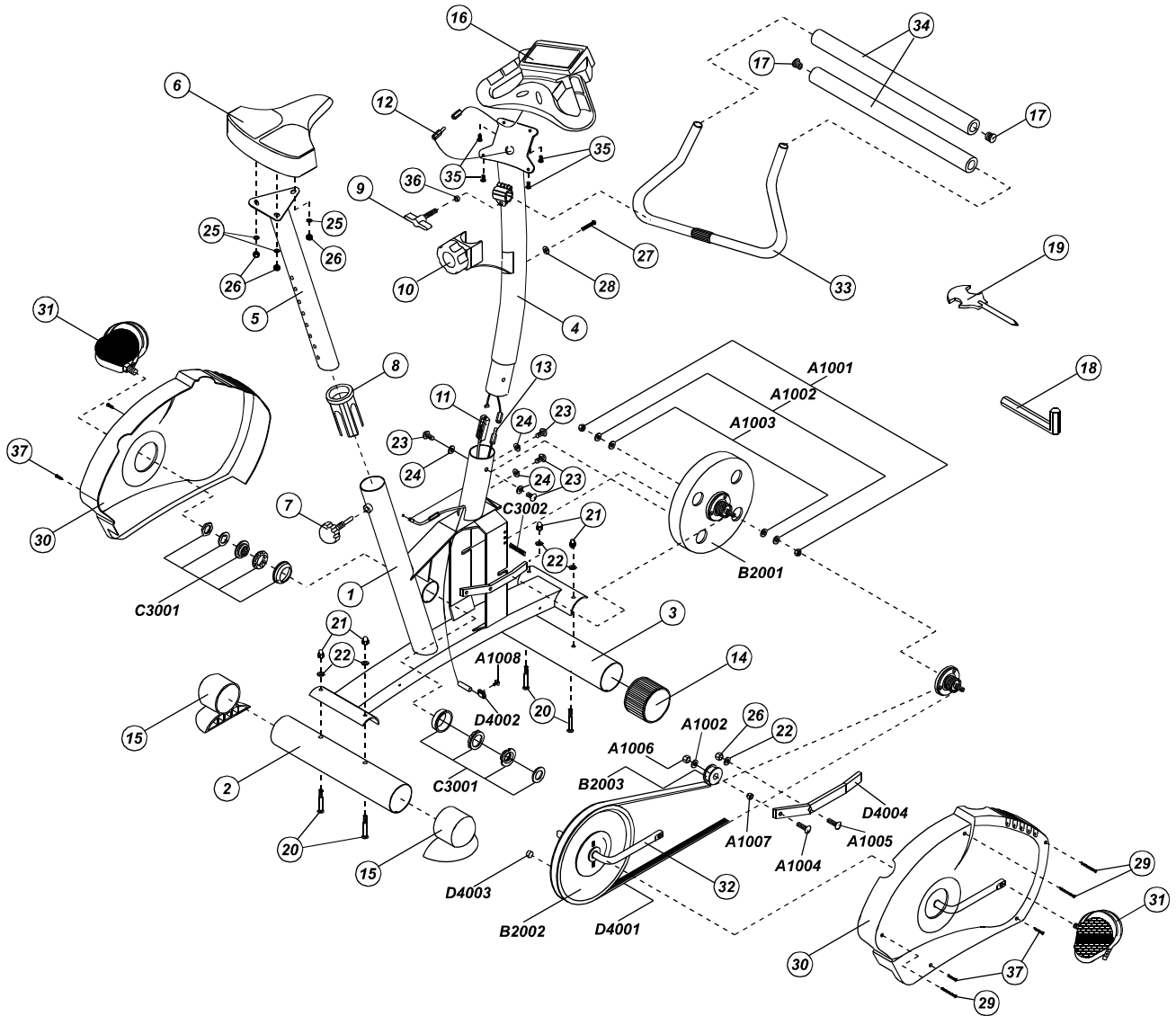

### OPERATING INSTRUCTIONS

Please refer to the separate operating instructions for the computer monitor that are included in the next section of this manual. The instructions below are for the operation of the bicycle only.

- Mount the exercise bicycle carefully. Make sure that the saddle post is securely mounted onto the frame, and is completely tightened down using the saddle post locking knob prior to mounting.
- Begin to pedal the bicycle. Keep both hands on the main handlebars except when reading your pulse rate (see computer section). Note that the main handlebars can be adjusted by loosening the locking knob and adjusting the handlebar location closer to the user or farther away. Be sure to lock these handlebars in place prior to commencing the exercise.
- Alter the resistance level of the pedaling action by turning the tension control dial on the front of the frame. There are 8 resistance settings. Setting number 1 is the lightest tension level, and number 8 is the highest or most difficult. The tension can be changed in either direction during the workout to suit your fitness level.
- Do not attempt to turn the tension control beyond level 1 or level 8. Doing so may result in permanent damage to the tension control system.

COMPUTER OPERATION**FUNCTION BUTTONS:**

**MODE** - Use to select the function to be preset. Hold for three seconds to display ACCUMULATED VALUES.

**SET** - Press to increase the value of TIME, DISTANCE, CALORIES or PULSE.

**RESET** - Press to reset all the values to zero except ACCUMULATED DISTANCE.

**RECOVER** - Press this button to start the RECOVERY function.

**BATTERY REPLACEMENT:**

1. Install two AA or UM-3 batteries into the battery case at the back of the monitor.
2. Ensure that the batteries are correctly positioned on the positive and negative terminals.
3. If the display appears blank or only partially illuminated, take out the batteries, wait for 15 seconds, and then reinsert.
4. Whenever the batteries are removed, all the function values will be reset to zero.  
Dispose of used batteries properly.

**FUNCTIONS:****AUTO ON/OFF –**

The monitor will turn on automatically by pressing any key or starting exercise. If you stop exercising for more than 4 minutes the monitor will turn itself off and reset all function values to zero (except ACCUMULATED DISTANCE).

**SPEED –**

Current speed will be shown on the main screen at all times from 0.0 - 99.9Km per Hour or Mile per Hour.

**PRESET –**

How to preset TIME, DISTANCE, CALORIES and PULSE:

1. Press the MODE button until the area of the lower screen that you want to preset is flashing.
2. Press the SET button until the desired number is displayed.
3. Once exercise has started, the monitor will begin to count down.

**COMPUTER OPERATION**

4. The monitor will beep for 10 seconds at the completion of workout that was preset. Press any button to stop the beeping.

**REMARKS –**

1. It is suggested to preset only one item. If more than one item is set, the first to reach the preset value will sound the alarm.
2. For the PULSE function, the monitor will not beep after reaching the preset value. The pulse display will flash continuously while the actual heartbeat detected is over the preset value.

**TIME –**

Displays the total workout time from 00:00 up to 99:59 minutes.

**DISTANCE –**

Displays the training distance from 0.0 to a maximum of 999.9 Kilometers or Miles in increments of 0.1 Kilometers or Miles.

**CALORIES –**

Displays estimated calories burned during training from 0.0 to a maximum of 999.9 KCAL in increments of 0.1 KCAL.

**PULSE –**

User's current heart rate is displayed in beats per minute (BPM). Place the palms of your hands on both of the pulse sensors and wait for 30 seconds for the most accurate reading.

**RECOVERY –**

The RECOVERY function measures your body's ability to recover after exercise. You can find the result displayed in the first left square of the lower screen. Recovery is measured on a scale of F1.0 to F6.0 in increments of 0.1. While F1.0 means the best, F6.0 means the worst. In addition, your peak heart rate right after exercising is displayed in the second right square of the lower screen. In order to measure recovery rate accurately, users must test it immediately once the workout is finished by first pressing the RECOVERY button and then stop exercising completely. After pressing the RECOVERY button be sure to put both hands on the pulse sensors. The test will last for 1 minute and the result will be displayed on the monitor. You can improve your recovery rate through exercise. You can exit the RECOVERY mode by pressing the RECOVERY button again.

## IMPORTANT STEPS

### **Warning:**

Before using this product, please consult your personal physician for a complete physical examination. Your doctor should approve frequent and strenuous exercise first. If any discomfort should result from your use of this product, stop exercising and consult your doctor. Proper usage of this product is essential. Please read your manual carefully before exercising.

Please keep all children away from the equipment during use and when equipment is unattended.

Always wear appropriate clothing, including athletic shoes, when exercising. Do not wear loose clothing that could become caught during exercising.

Make sure that all bolts and nuts are tightened when equipment is in use. Periodic maintenance is required on all exercise equipment to keep it in good condition.

### **Before beginning:**

How you begin your exercise program depends on your physical condition. If you have been inactive for several years, or are severely overweight, you must start slowly and increase your time gradually, a few minutes per week.

Initially you may be able to exercise only for a few minutes in your target heart rate zone. However, your aerobic fitness will improve over the next six to eight weeks. Don't be discouraged if it takes longer. It's important to work at your own pace. Ultimately, you'll be able to exercise continuously for 30 minutes. And the better your aerobic fitness, the harder you will have to work to stay in your target heart rate zone. But remember these essentials:

- Contact your physician before starting a workout or training program. Have your doctor review your training and diet programs to advise you of a workout routine you should adopt.
- Begin your training program slowly with realistic goals that have been set by you and your doctor.
- Supplement your program with some type of aerobic exercise such as walking, jogging, swimming, dancing and/or bicycling. Monitor your pulse frequently. If you do not have an electronic heart rate monitor, have your physician show you the proper way to manually check your pulse by using your wrist or neck. Establish your target heart rate based on your age and condition.
- Drink plenty of fluids during the course of your routine. You must replace the water content lost from excessive exercising to avoid dehydration. Avoid drinking large amounts of cold liquids. Fluids should be at room temperature when consumed.



The Surgeon General  
has determined that lack  
of physical activity is  
detrimental to your health.™

**MAINTENANCE REQUIRED**

**Following are the steps required to maintain your 605 Magnetic Bike.**

1. Before use each time, check to insure that all nuts and bolts are tightened. Pay close attention to the seat mount, seat post and pedals.
2. When the workout is complete, wipe off the sweat from your workout that has fallen on the electronics or any painted parts, including the frame. This will help to prevent corrosion.
3. Apply some type of light machine oil (we recommend WD-40) to moving parts including the area around the pedal crank arms where they go into the crank, as well as the pedal axles. Only a very small amount (1 or 2 sprays) is required. This only needs to be done every 6-12 months depending upon use of the product.

If you have any questions, call our toll-free customer service number at 888-535-8637.



## TRAINING INSTRUCTIONS

### TRAINING INSTRUCTIONS:

To achieve a considerable improvement of your physical fitness level and general health, some aspects of how to find the most efficient amount of training should be followed: NOTE: If you have not been physically active for a long period of time be sure to avoid health risks and consult your general physician before starting to exercise.

#### Intensity -

To achieve maximum results the right intensity has to be chosen. The heart rate is used as a guideline to calculate the right intensity. As a rule of thumb the following formula is commonly used:

$$\text{Maximum heart rate} = 220 - \text{Age}$$

While exercising your heart rate should always be between 60% and 85% of your maximum heart rate. For your personal training rates please see the target heart rate chart page in this manual. When starting to exercise you should keep your rate at 60% of your maximum heart rate in the first couple of weeks. With increasing improvement of fitness the heart rate should be slowly increased to 85% of your maximum heart rate.

#### Fat burning -

The body starts to burn fat at approximately 60% of the maximum heart rate. To reach an optimum fat burning rate, it is advisable to keep the heart rate between 60% and 70% of the maximum heart rate. The optimum training amount consists of three workouts per week of 30 minutes each.

#### Example -

You are 52 years of age and would like to start exercising.  
Maximum heart rate:  $220 - 52(\text{age}) = 168$  beats per minute  
Minimum heart rate:  $168 \times 0.6 = 101$  beats per minute  
Highest heart rate:  $168 \times 0.7 = 117$  beats per minute

During the first few weeks it is advisable to start with a heart rate of 101, afterwards increase it to 117. As your fitness level improves the training intensity should be increased to 70% - 85% of your maximum heart rate. Increasing the resistance, frequency or length of your workout periods can do this.

### TRAINING ORGANIZATION:

#### Warm up -

Before every training session you should warm-up for 5-10 minutes. Here you can do some light stretching or training with low resistance. You will find a warm-up and cool-down stretching guide printed in this manual.

#### Training session -

During the actual training session a rate of 70% -85% of your maximum heart rate should be chosen. The time length of your training session can be calculated with the following rule of thumb:

- Daily training session: approx. 10 min. per unit
- 2-3 x per week: approx. 30 min. per unit
- 1-2 x per week: approx. 60 min. per unit

#### Cool down -

To introduce an effective cool-down of the muscles and the metabolism the intensity of your workout should be drastically decreased during the last 5 - 10 minutes of exercise. Stretching is also helpful for the prevention of muscle aches. You will find a warm-up and cool-down stretching guide printed in this manual.

#### Success -

Even after only a short period of regular exercising you will notice that your fitness level will increase and you will constantly have to increase the resistance to reach your target heart rate.

## TARGET HEART RATE

### Finding your pulse:

To make sure your heart is beating in its target zone, you'll need to know how to monitor your heart rate. The easiest way is to feel the pulse in the carotid artery on either side of your neck, between the windpipe and the large neck muscles. Count the number of beats in ten seconds, and then multiply that number by six. This gives you the number of beats per minute.

How fast should your heart beat during aerobic exercise? Fast enough to reach and stay in its "target zone," a range of beats per minute that is largely determined by your age and physical condition. To determine your target zone, consult the chart we have provided.

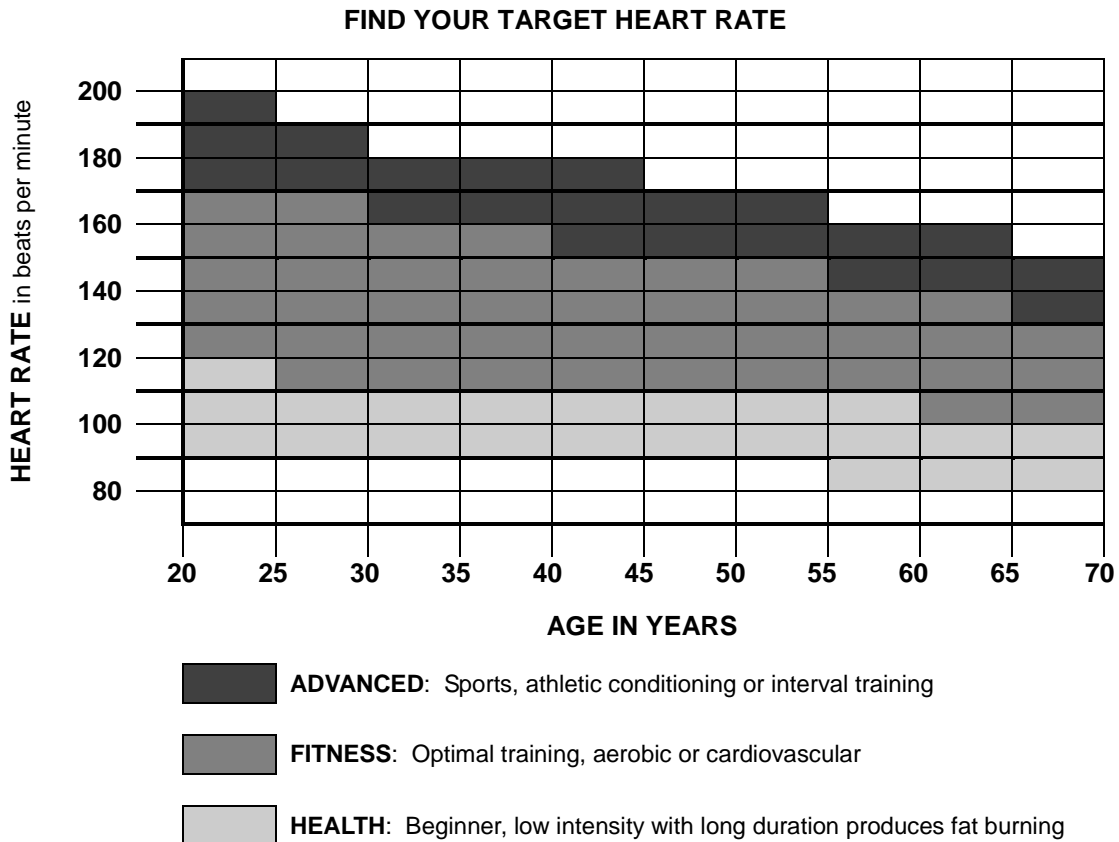

### Aerobic exercise:

Is any sustained activity that sends oxygen to your muscles via your heart and lungs. It will improve the fitness of your lungs and heart: your body's most important muscle. Aerobic fitness is promoted by any activity that uses your large muscle groups - arms, legs or buttocks, for example. Your heart beats quickly and you breathe deeply. An aerobic exercise should be part of your entire exercise routine.

**MUSCLE CHART****Targeted muscle groups:**

The exercise routine that is performed on this product will develop primarily lower body muscle groups. These muscle groups are shown on the chart below.

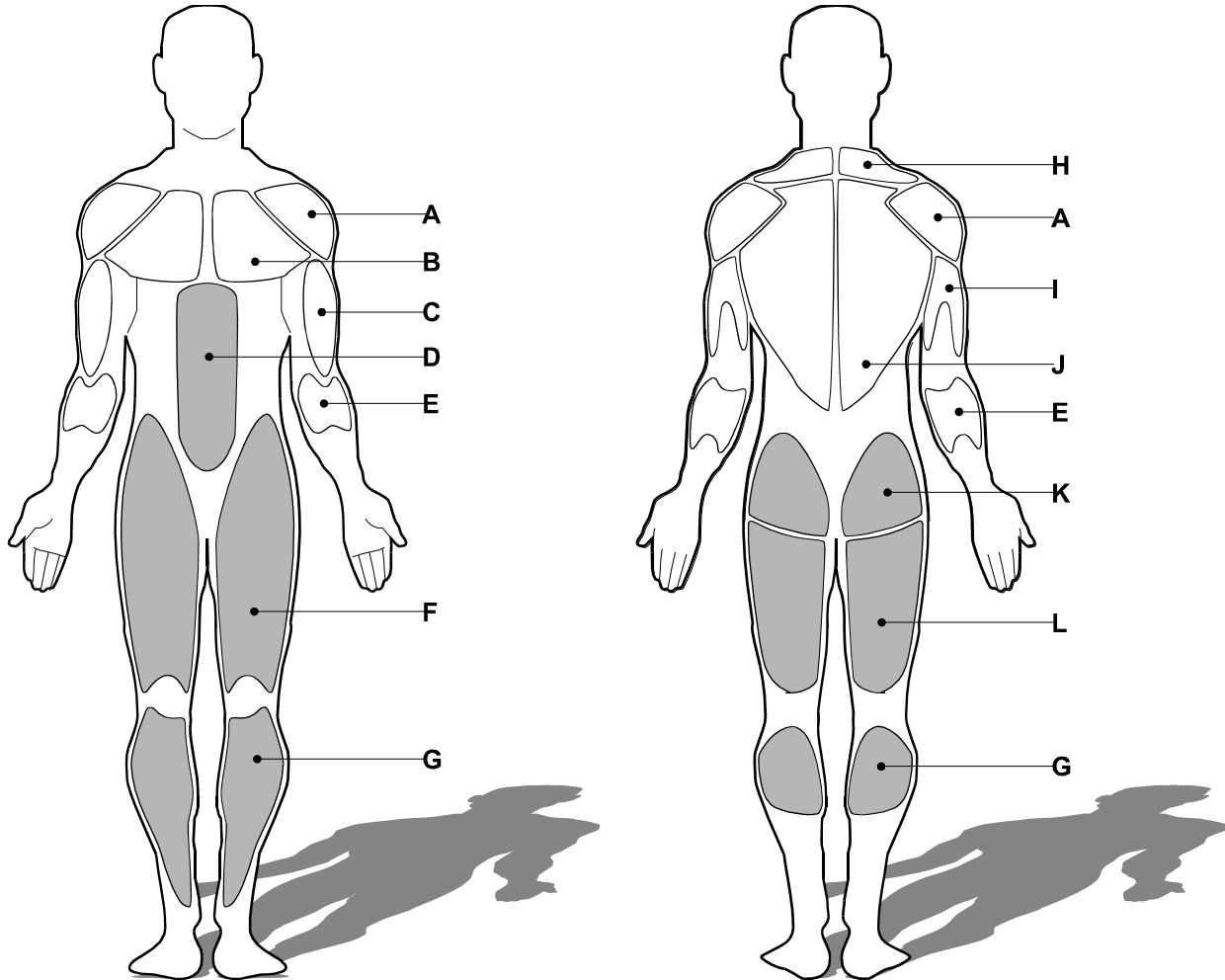

Shoulder muscles	<input type="checkbox"/> A	<input type="checkbox"/> B	Pectoral muscles
Bicep muscle	<input type="checkbox"/> C	<input type="checkbox"/> D	Abdominal muscles
Forearm muscles	<input type="checkbox"/> E	<input type="checkbox"/> F	Quadricep muscles
Calf muscles	<input type="checkbox"/> G	<input type="checkbox"/> H	Trapezius muscles
Tricep muscles	<input type="checkbox"/> I	<input type="checkbox"/> J	Back muscles
Gluteal muscles	<input type="checkbox"/> K	<input type="checkbox"/> L	Hamstring muscles

## STRETCHING ROUTINE

### **Warm up and cool down:**

A successful exercise program consists of a warm-up, aerobic exercise, and a cool-down. Do the entire program at least two and preferably three times a week, resting for a day between workouts. After several months, you can increase your workouts to four or five times per week.

Warming up is an important part of your workout, and should begin every session. It prepares your body for more strenuous exercise by heating up and stretching out your muscles, increasing your circulation and heart rate, and delivering more oxygen to your muscles. At the end of your workout, repeat these exercises to reduce sore muscle problems. We suggest the warm-up and cool-down stretches on the following pages:

### **Toe Touch:**

Slowly bend forward from your waist, letting your back and shoulders relax as you stretch toward your toes. Reach down as far as you can and hold for 15 counts.

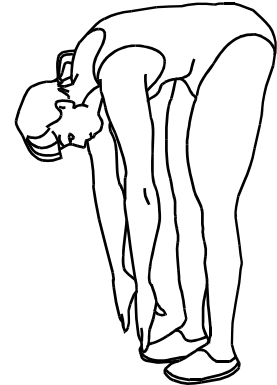

### **Shoulder Lift:**

Lift your right shoulder up toward your ear for one count. Then lift your left shoulder up for one count as you lower your right shoulder.



### **Head Roll:**

Rotate your head to the right for one count, feeling the stretch up the left side of your neck. Next, rotate your head back for one count, stretching your chin to the ceiling and letting your mouth open. Rotate your head to the left for one count, and finally, drop your head to your chest for one count.



STRETCHING ROUTINE**Hamstring Stretch:**

Sit with your right leg extended. Rest the sole of your left foot against your right inner thigh. Stretch toward your toe as far as possible. Hold for 15 counts. Relax and then repeat with left leg extended.

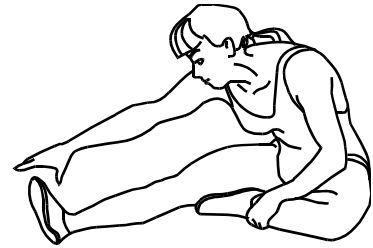
**Inner Thigh Stretch:**

Sit with the soles of your feet together with your knees pointing outward. Pull your feet as close into your groin as possible. Gently push your knees towards the floor. Hold for 15 counts.

**Side Stretch:**

Open your arms to the side and continue lifting them until they are over your head. Reach your right arm as far upward toward the ceiling as you can for one count. Feel the stretch up your right side. Repeat this action with your left arm.

**Calf-Achilles Stretch:**

Lean against a wall with your left leg in front of the right and your arms forward. Keep your right leg straight and the left foot on the floor; then bend the left leg and lean forward by moving your hips toward the wall. Hold, and then repeat on the other side for 15 counts.

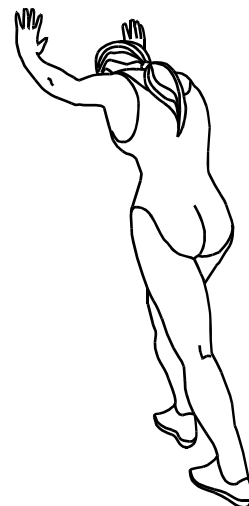

## WARRANTY

**Warranty Coverage:** Phoenix Health and Fitness, Inc. ("Phoenix Health and Fitness") warrants to the original purchaser that each new product to be free from defects in workmanship and material, under normal use and conditions.

**Period of Coverage:** The Warranty on this product runs for a period of NINETY (90) days on parts and TWO (2) years on the steel frame from the date of your purchase.

It is recommended that the Original Receipt be kept with the product manual.

**Remedy Provided by Phoenix Health and Fitness:** Phoenix Health and Fitness will provide a replacement part free of charge if a defect is found during the Warranty period. You must pay any charges for shipping and handling outside of the Continental United States and for labor. You may select any reputable service center to install any replacement part.

Parts repaired or replaced pursuant to this Warranty shall be warranted for the unexpired portion of the Warranty applying to the original product. Any technical advice furnished before or after delivery in regard to the use or application of Phoenix Health and Fitness products is furnished without charge and on the basis that it represents Phoenix Health and Fitness' best judgment under the circumstances but that the advice is used at your sole risk.

**Procedure for Obtaining Your Remedy Under This Warranty:** In the event you discover a defect in this product, please phone our Customer Service Department at 1 (888) 535.8637 between the hours of 8:00 a.m. and 4:00 p.m. (Pacific Standard Time). You may order your free replacement part at that time, and you may obtain assistance from our Customer Service professionals. Parts will be shipped to you within ninety (90) days of your notification to our Customer Service Department of your Warranty claim. To help us assist you, please have the following information ready:

- Model name or number from the cover of the manual;
- Serial number located on the frame of the unit; and
- The part description and the order number.

You may also fax your parts request to Phoenix Customer Service at 562-903-8558. You must include the part number and ship to address along with your telephone number.

**Limitations on Warranty:** This Warranty does not apply to you if you have purchased this product for resale. This Warranty does not cover any problems, damages or failures that are caused by accident, improper assembly, failure to observe cautionary labels on the product, failure to operate the product correctly, abuse or freight damage. Phoenix Health and Fitness does not warrant against any damage or defects that may result from repair or alterations made to the product by a repair facility.

This Warranty shall terminate if you sell or otherwise transfer this product. This Warranty does not apply to any product shipped or handled outside of the United States. This Warranty does not apply if the product is used for rental or commercial use. Consequential and incidental damages are not recoverable under this Warranty. (Some states do not allow the exclusion or limitation of incidental or consequential damages, so the above limitation or exclusion may not apply to you.)

THIS WARRANTY IS EXPRESSLY IN LIEU OF ALL OTHER EXPRESS WARRANTIES. ALL IMPLIED WARRANTIES, INCLUDING WARRANTIES OF MERCHANTABILITY OR FITNESS FOR ANY PARTICULAR PURPOSE, ARE LIMITED IN DURATION TO ONE (1) YEAR FROM THE EFFECTIVE DATE OF THIS WARRANTY. PHOENIX HEALTH AND FITNESS IS NOT LIABLE FOR CONSEQUENTIAL OR INCIDENTAL DAMAGES RESULTING FROM ANY DEFECT IN PARTS NOR FOR ANY BREACH OF EXPRESS OR IMPLIED WARRANTIES. PHOENIX HEALTH AND FITNESS' SOLE LIABILITY UNDER THIS WARRANTY IS LIMITED TO THE TERMS DESCRIBED IN THIS FORM.

THIS WARRANTY GIVES YOU SPECIFIC LEGAL RIGHTS, AND YOU MAY ALSO HAVE OTHER RIGHTS WHICH VARY FROM STATE TO STATE.

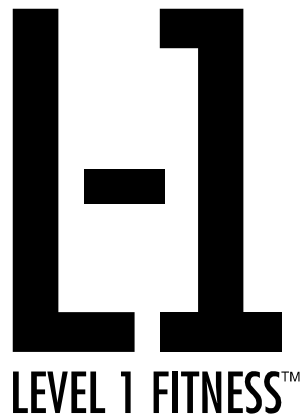

Distributed by:

Phoenix Health and Fitness  
9115 Dice Road  
Unit 12  
Santa Fe Springs, CA 90670

Toll Free Customer Service:  
**1.888.535.8637**

Website:  
[www.phoenixhealthandfitness.com](http://www.phoenixhealthandfitness.com)