

# Elite

BY MAXI-MATIC

P L A T I N U M

## 4 QT. DIGITAL PRESSURE COOKER

Model: EPC-414(A~Z)

### INSTRUCTION MANUAL

Before operating your new appliance, please read all instructions carefully and keep for future reference.



Questions? Elite's customer service team is ready to help.

Call us toll-free at 800-365-6133 ext. 120/107/105.

For more Elite products, visit us at [www.maxi-matic.com](http://www.maxi-matic.com) or email us at [info@maxi-matic.com](mailto:info@maxi-matic.com).

Recipes are included in this manual.

# TABLE OF CONTENTS

IMPORTANT SAFEGUARDS	2-3
SAFETY WARNING/ADDITIONAL SAFETY TIPS	4
E1 - E4 ERROR INDICATOR	4
ABOUT YOUR PRESSURE COOKER	5
SHORT CORD PURPOSE/POLARIZED PLUG	6
PARTS IDENTIFICATION	7
PRESSURE COOKER LID MARKINGS	8
RUBBER SEAL RING ASSEMBLY	8
BEFORE FIRST USE	9
<i>Lid assembly</i>	9
PREPARING YOUR PRESSURE COOKER	10-12
<i>Opening the lid</i>	10
<i>Closing the lid</i>	11
OPERATING INSTRUCTIONS	13-18
<i>How to use the menu buttons</i>	13-15
<i>How to use the pressure cook time button</i>	15-16
<i>How to use the delay timer</i>	16-17
<i>How to brown/saute with your pressure cooker</i>	17
<i>How to use the keep warm function</i>	18
<i>How to use the slow cook function</i>	18
<i>How to use the steam function</i>	19
<i>How to cook with frozen foods</i>	19
<i>How to use the pressure cooker for canning</i>	20-21
HELPFUL TIPS	22
HOW TO CLEAN YOUR PRESSURE COOKER	23
TROUBLESHOOTING	24-25
COOKING TIME CHART	26-29
RECIPES	30-66
<i>Savory pressure cooker recipes</i>	30-50
<i>Desserts</i>	50-55
<i>Canning recipes</i>	56-59
<i>Slow cooker recipes</i>	60-66
WARRANTY AND RETURN INSTRUCTIONS	67-68

# IMPORTANT SAFEGUARDS

When using pressure cookers, basic safety precautions should always be followed:

1. Read all instructions before operation.
2. Do not operate while unattended.
3. Do not touch hot surfaces. Use handles or knobs.
4. Close supervision is necessary when the pressure cooker is used near children.
5. DO NOT allow children to operate under any circumstance.
6. Do not place the pressure cooker in a heated oven.
7. Extreme caution must be used when moving a pressure cooker containing hot liquids.
8. Do not use pressure cooker for other than intended use.
9. To protect against electrical shock do not immerse cord, plugs, or main body in water or other liquid.
10. This appliance cooks under pressure. Improper use may result in scalding injury.
11. Make certain unit is properly closed before operating. See "Operating Instructions".
12. Do not fill the unit over 2/3 full. When cooking foods that expand during cooking such as rice or dried vegetables, do not fill the unit over 1/2 full. Over filling may cause a risk of clogging the vent pipe and developing excess pressure. Failure to follow this procedure can result in injury to person(s) and/or damage to the unit.
13. Be aware that certain foods, such as applesauce, cranberries, pearl barley, oatmeal or other cereals, split peas, noodles, macaroni, rhubarb, or spaghetti can foam, froth, and sputter, and clog the pressure release device (steam vent). These foods should not be cooked in a pressure cooker.
14. When the normal operating pressure is reached, turn the heat down so all the liquid which creates the steam does not evaporate.
15. Always check the pressure release devices for clogging before use.
16. Do not open the pressure cooker until the unit has cooled and all internal pressure has been released. If the handles are difficult to push apart, this indicates that the cooker is still pressurized – do not force it open. Any pressure in the cooker can be hazardous. See Operating Instructions.
17. Do not use this pressure cooker for pressure frying with oil.
18. DO NOT place the product near flammable materials or use in a humid environment.
19. DO NOT damage the Seal Belt and DO NOT replace it with anything other than the replacement belt designated for this unit.
20. DO NOT tamper with the Steel Ring in the Lid (2) with any tools or external forces. If the Steel Ring is damaged, please stop using immediately and replace the Lid.
21. Clean the Filter (17) regularly to keep the cooker clean.
22. NEVER use additional weight on the Pressure Limiting Valve (3) or replace the Pressure Limiting Valve (3) with anything not intended for use with this unit.
23. The surface of contact between the Inner Pot (6) and the Electronic Heater (14) should always be clean. DO NOT use the Inner Pot with other heating sources. DO NOT replace the Inner Pot with a container other than what is recommended by the manufacturer.
24. The Inner Pot consists of a non-stick layer surface. To avoid scratching the non-stick surface, please use wooden or plastic utensils.

# IMPORTANT SAFEGUARDS

25. Food should not be kept warm for more than 4 hours in order to maintain the freshness of the food. The pressure cooker should not be used for more than 6 hours continuously. Serious Injury and/or damage may occur if any safeguards are ignored.
26. If steam escapes around the Lid during the cooking process, please unplug from the power supply immediately and allow to cool. Check that the Rubber Seal Ring (18) is securely and properly fitted to the Inner Lid (2). If problem persists, contact the manufacturer for exchange or repair.
27. If there is any malfunction of the cooker during the cooking process, please stop using the device and return to the manufacturer for repair or exchange.
28. Do not let cord hang over edge of table or counter, or touch hot surfaces.
29. Unplug from outlet when not in use and before cleaning. Allow to cool before putting on or taking off parts.
31. Do not operate this appliance with a damaged cord or plug or after it malfunctions or has been damaged in any manner. Bring it to a qualified technician for examination, repair or electrical or mechanical adjustment. DO NOT disassemble the product, or replace parts with parts not intended for this unit.
32. Always attach plug to appliance first, then plug cord into the wall outlet. To disconnect, turn any control to off, then remove plug from wall outlet.
33. Do not use outdoors.
34. Do not place on or near a hot gas or electric burner, or in a heated oven.
35. Any other servicing should be performed by an authorized service representative.
36. The use of accessory attachments not recommended by the appliance manufacturer may cause injuries.
37. Some countertop and table surfaces, such as Corian®, wood and / or laminates, are not designed to withstand prolonged heat generated by certain appliances. It is recommended by countertop manufacturers and Maxi-Matic that a hot pad or trivet be placed under your appliance to prevent possible damage to the surface.

**SAVE THESE INSTRUCTIONS  
FOR HOUSEHOLD USE ONLY**

# Safety Warning

- There is a potential risk of fire, electric shock or injury to persons if the product is not used as instructed. Protection against electric shock is assured only if the main power cord is connected to a properly grounded 120V | 60Hz power receptacle.
- This product is to be used in an indoor environment only and is not intended for commercial use. Dry locations only.
- All parts and accessories for this appliance must be used properly according to the instructions. All parts and accessories must be the original provided from manufacturer. All other parts or accessories that is not intended for use with this appliance is strictly prohibited.
- The use of an extension cord, power adapter or other electric devices is highly not recommended.

## Additional Safety Tips

- Always keep hands and face away from Pressure Release Device when releasing pressure.
- Use extreme caution when removing the lid after cooking. Always tilt the lid away from you, so any remaining steam is away from your face.
- Never attempt to open lid while cooking, or before float valve (4) has dropped. Do not attempt to defeat this safety feature by forcing lid open.
- Do not cover or block the pressure valves.
- Do not touch the pot or lid except for the handle immediately after using.
- To avoid burns, allow food to cool before tasting. The temperature of the food gets considerably hotter than with conventional cooking.

## LED Error Indicator

- If any of the below error codes appear on the pressure cooker display, unplug the power cord and re-plug after 10 minutes. If the error code remains, contact the manufacturer for a replacement part.
- See Troubleshooting on page 25 for instructions regarding an E4 error.

Indicator Code	Problems/Causes
E1	Open Circuit of the Sensor
E2	Short Circuit of the Sensor
E3	Overheating
E4	Signal Switch Malfunction

# ABOUT YOUR PRESSURE COOKER

This digitally controlled and automatic pressure cooker uses advanced technology so you and your family can enjoy the benefits of better, faster and healthier cooking. Your Elite Platinum Pressure Cooker seals in steam to cook hotter and faster while maintaining important nutrients for healthier meals. Cooking fast and with less water saves vital natural resources and energy! The unit features easy touch-button settings, a countdown timer, and a cooking pot large enough for family gatherings! It's the easiest pressure cooker to use on the market. It may seem like a complicated unit but rest assured, this pressure cooker is simple to use, makes meals quick and easy, and overall it saves you money! Please accept our thanks for purchasing an Elite Platinum Pressure Cooker and Enjoy!

## **PRESSURE COOKER WITH MULTIPLE FUNCTIONS:**

- Multiple functions for cooking, stewing, braising, simmering, and roasting.
- Cooking will be done automatically by selecting the different menu choices on the unit. When the food has completed its cooking cycle, there will be a (3) beep indicator, followed by the unit automatically switching to the Keep Warm mode.
- A delay timer allows the user to delay the start of cooking by up to 24-hours. When the timer is set, the count-down will start. At the end of the countdown, the cooker will start to heat up.
- The pressure cooker also has its own memory. During interruptions such as a power failure, the unit will automatically renew the cooking cycle where the unit left off when the power resumes.

## **RAPID COOKING; TIME & POWER SAVING:**

Pressure cooking is an ideal method for making fast, tasty meals! Pressure cooking allows even the busiest cooks to prepare meals from scratch easily and best of all, quickly. Your new Elite Platinum 4Qt. pressure cooker can be used to cook meats, seafood, beans, grains and even dessert - all in just minutes. It saves you time and energy consumption by cooking foods fast while retaining valuable nutrients.

## **PRESERVES NUTRIENTS & PROMOTES HEALTHY EATING:**

Cooking inside a pressure-sealed pot produces steam which helps break down the fibers in food and intensify the flavors of food with the marinades or seasonings you've used. The shortened cook-time combined with steam-infused cooking result in a higher retention of nutrients when compared to conventional cooking methods such as boiling, steaming or roasting.

## SHORT CORD PURPOSE

**NOTE:** A short power cord is provided to reduce the risk of personal injury resulting from becoming entangled in or tripping over a longer cord.

**Longer power-supply cords or extension cords are available and may be used if care is exercised in their use.**

If an extension cord is used: (1) the marked electrical rating of the extension cord should be at least as great as the electrical rating of the product; (2) the extension cord should be arranged so that it will not drape over the countertop or tabletop where it can unintentionally be pulled on or tripped over by children or pets.

## POLARIZED PLUG

If this appliance is equipped with a **polarized plug** (one blade is wider than the other), please follow the below instructions:

To reduce the risk of electrical shock, this plug is intended to fit into a polarized outlet only one way. If you are unable to fit the plug into the electrical outlet, try reversing the plug. If the plug still does not fit, contact a qualified electrician. Never use the plug with an extension cord unless the plug can be fully inserted into the extension cord. Do not alter the plug of the product or any extension cord being used with this product. Do not attempt to defeat the safety purpose of the polarized plug.

### STOP

This is NOT a Stovetop Pressure Cooker.

Under NO circumstances should this Pressure Cooker or any of its parts or components be placed ON or NEAR a Stovetop, Range, or Open Flame.

Doing so will cause serious damage to the Pressure Cooker and/or injury to person.

### NOTE

The Inner Pot (6) consists of a non-stick surface. To avoid scratching the non-stick surface, please use wooden or plastic utensils.

# PARTS IDENTIFICATION

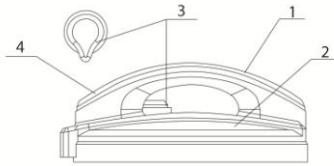
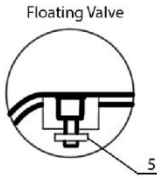

Dismantling of condensation cup

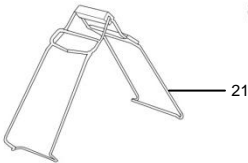
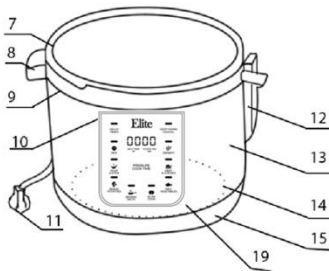
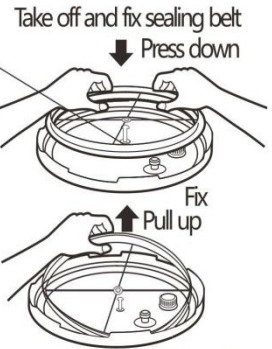
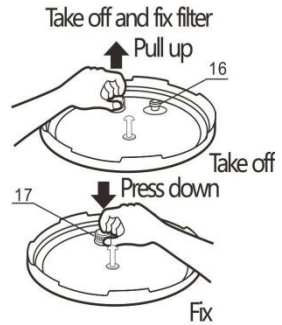

- |                                |                               |                                |
|--------------------------------|-------------------------------|--------------------------------|
| 1. Handle                      | 9. Upper Ring                 | 17. Filter                     |
| 2. Lid                         | 10. Control Panel             | 18. Rubber Seal Ring           |
| 3. Pressure Limiting Valve     | 11. Power Cable               | 19. Sensor                     |
| 4. Float Valve (external view) | 12. Condensation Cup          | 20. Stainless Steel Rack       |
| 5. Float Valve (internal view) | 13. Main Body                 | 21. Tongs/Rack or Plate Lifter |
| 6. Inner Pot                   | 14. Electronic Heater         |                                |
| 7. Outer Pot                   | 15. Bottom Ring               |                                |
| 8. Handle                      | 16. Seal Ring for Float Valve |                                |



# PRESSURE COOKER LID MARKINGS

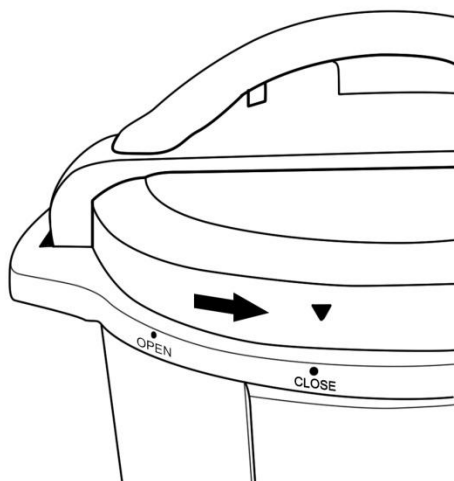

Please note the "OPEN" and "CLOSE" markings on the Upper Ring (9) of the pressure cooker body (13) and the "▽" on the rim of the Lid (2). To properly close and secure the pressure cooker Lid (2), always line up the "CLOSE" marking on the Upper Ring (9) and the "▽" on the rim of the Lid (2). (Figure 1)

1

# RUBBER SEAL RING ASSEMBLY

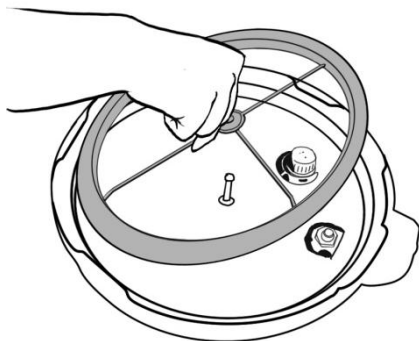

2A

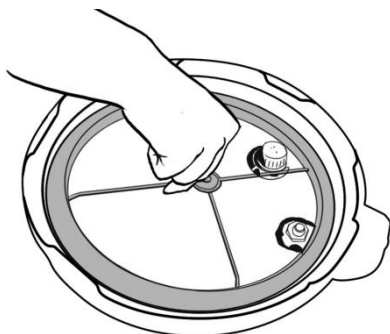

2B

Always ensure the Rubber Seal Ring (18) is securely fitted onto the metal ring in the interior of the Lid (2). The Rubber Seal Ring (18) should fit around the outside of the entire metal ring. Make sure the crease in the Rubber Seal Ring (18) meets with the metal ring all the way around. Then place the metal ring and Rubber Seal Ring (18) back into the Lid (2) making sure the hole in the center of the metal ring's cross-section is lined up with the metal pin in the center of the Lid (2). Press down firmly until the metal ring is secured onto the Lid (2) (Figures 2A – 2B).

# BEFORE FIRST USE

Working Pressure	PSI	Maximum Pressure	Keep Warm Temperature	Delay Timer
0~70kPa	12 PSI	90kPa	140°F ~ 175 °F	0.5~24 HR

1. Remove packaging materials such as cardboard, plastics or Styrofoam and discard appropriately.
2. Clean all the parts by wiping with a soft damp cloth or sponge and dry thoroughly.

## LID ASSEMBLY:

**How to open the lid:** Hold the handle (1) firmly, turn the lid (2) clockwise until it loosens and lift vertically (Figures 3-4).

**Note:** For new units, the seal of the lid (2) may be slightly stronger than normal and may be slightly difficult to unlock. Once the lid (2) has been opened and closed several times, it will loosen up.

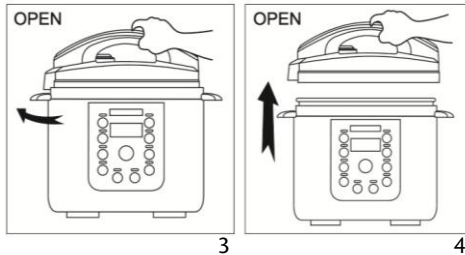

**How to close the lid:** Hold the handle (1) and close it downwards at the Opened Lid position (Figure 5). Turn counter-clockwise until you reach the Closed Lid position (Figure 6).

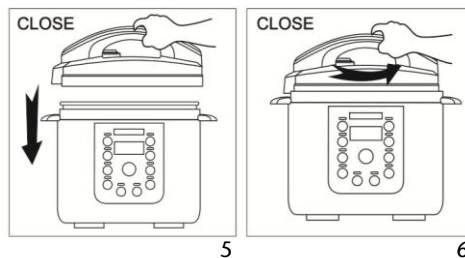

# PREPARING YOUR PRESSURE COOKER

1. **Opening the lid:** Hold the handle (1) firmly, turn the lid (2) clockwise until it loosens and lift vertically (See Figures 7-8).

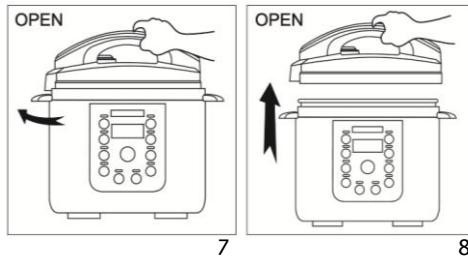

2. Remove the inner pot (6) and add desired ingredients. The amount of water and food should not exceed  $\frac{2}{3}$  of the height of the inner Pot (6) (Figure 9). For food that will expand in water, the level should not exceed  $\frac{1}{2}$  of the Inner Pot (6) (Figure 10). The minimum level for cooking would be  $\frac{1}{5}$  of the Inner Pot (6) (Figure 11).

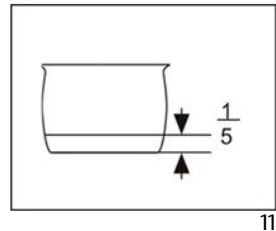
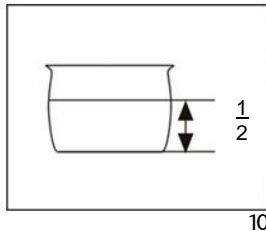
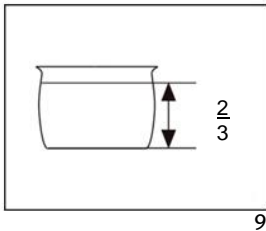

3. Be certain the inner receptacle, where the Electronic Heater is located, is clean and dry before inserting the Inner Pot (6) into the pressure cooker and adjust the pot left and right to ensure optimal contact between the Inner Pot and the Electronic Heater (Figure 12).

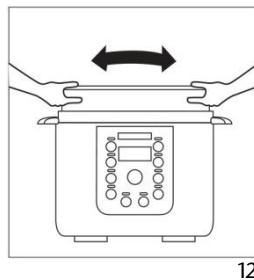

## Cooking Rice

When cooking rice, the maximum amount of rice allowed for this 4 quart pressure cooker is 8 cups of uncooked rice.

Normally one cup of rice requires one cup of water. This may vary according to taste.

# PREPARING YOUR PRESSURE COOKER (CONT.)

4. **Closing the Lid:** Make sure the Rubber Seal Ring (18) is fitted properly onto the metal ring inside the lid (2). Observe the Rubber Seal Ring (18) inside the lid (2) and ensure that it is fitted onto the outer part of the metal ring all the way around. **(Caution: If the rubber seal ring is damaged, do not use the pressure cooker. Contact Customer Service to repair or replace.)**
5. Lift the lid (2) from the rested position. Close the lid (2). Hold the handle (1) and turn it Counter-Clockwise to the "LOCKED" position. (A clamping sound can be heard. See Figures 13-14).

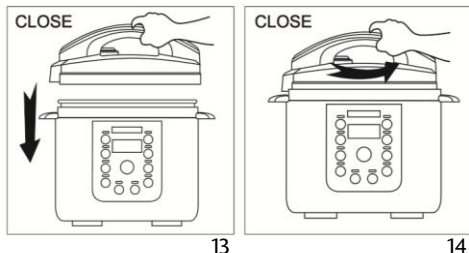

*Note: To ensure you are properly closing the lid (2), please make sure the pressure limiting valve (3) is on your left side when you are facing the front of the pressure cooker (when facing the control panel (10)).*

6. Adjust the Pressure Limiting Valve (3) to the "Air Tight" position, and ensure that the Float Valve (5) sinks.
7. When adjusting the Pressure Limiting Valve (3) to either the "Airtight" or the "Exhaust" positions, line up the marking on the Pressure Limiting Valve (3) with the arrow on the Handle (1) as shown in Figures 15 and 16.

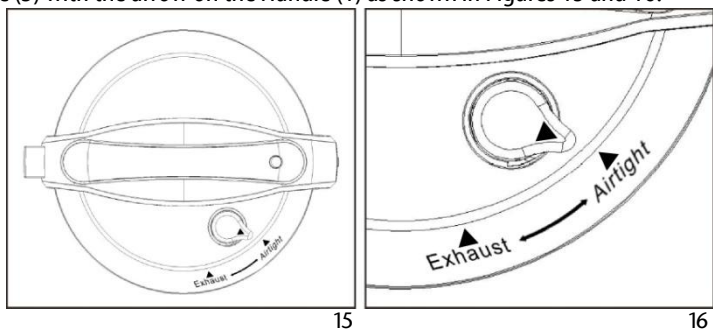

# PREPARING YOUR PRESSURE COOKER (CONT).

## NOTES & TIPS #1:

Please note that the Pressure Limiting Valve (3) will be loose when you are not using the unit for cooking. It will rock slightly and will turn 360° manually. Once the pressure cooker is in operation and the pressure has built up to its capacity, the Pressure Limiting Valve (3) will tighten but on the surface it will resemble a bobble-head, only allowing itself to be turned to “Exhaust”. Once all the pressure has released, it will become loose again.

## NOTES & TIPS #2:

During the Pressure Building process, you may notice steam or pressure escaping from the Pressure Limiting Valve (3). Carefully adjust the valve by moving it gently or turning it side to side gently using tongs or similar utensil until it seals properly.

If any steam is escaping around the lid, it means that the Rubber Seal Ring (18) may not have completed a tight seal when the lid was locked. This can happen to brand new units. Try pressing down firmly on the Lid (2). This should allow the Rubber Seal Ring (18) to seal and stop any more steam from releasing.

If this does not fix the issue, cancel the cooking process, release pressure manually or naturally, remove the lid and check the Rubber Seal Ring (18) and the Float Valve (5). See page 8 on how to install the Rubber Seal Ring (18). Note that the Float Valve (5) is properly assembled and you are able to pull it up and down with ease by grasping the Float Valve Seal Ring (16). Reposition the lid and ensure that it is secure. Start the cooking process again.

Please note that steam escaping from the Valve (3) or around the lid is normal for the first 5 minutes or so during the **pressure building process**. If it continues beyond 10 minutes or steam is still releasing when the timer has begun counting down, press down firmly on the Lid (2) to help form a tighter seal. If this does not fix the issue, press the **KEEP WARM/CANCEL** button and follow the instructions to release all pressure before removing the lid to check the Float Valve (5) or the Rubber Seal Ring (18).

## NOTES & TIPS #3:

\*\*At any point during the selection process or the cooking process, you can press the **CANCEL** button to cancel your selection or to cancel the cooking process.

# OPERATING INSTRUCTIONS

## HOW TO USE THE **MENU BUTTONS**:

There are eight **MENU BUTTONS** programmed for your pressure cooker. They are **SLOW COOK, SOUP & STEW, BEANS/GRAINS, BROWN/SAUTÉ, DESSERTS, STEAM, MEAT & CHICKEN, and RICE**. The default times are programmed for quick and easy cooking for small portions of food. (When cooking food that is more than 3lbs. or more than 6-cups, please use the Timed Cooking function.) Each of the default times is programmed to detect the weight of food being cooked and how much liquid is inside the pot during the cooking cycle. The unit will automatically build up the pressure, cook the food and go to **KEEP WARM** when cooking is complete.

MENU BUTTON	DEFAULT COOKING TIME	COOKING TIME RANGE
RICE	12 MIN	N/A
SOUP & STEW	25 MIN	1-90 MIN
MEAT & CHICKEN	12 MIN	5-60 MIN
SLOW COOK	6 HOURS	0.5-9.5 HOURS
BEANS & GRAINS	40 MIN	10-90 MIN
BROWN/SAUTÉ	5 MIN	3-8 MIN
STEAM	5 MIN	3-25 MIN
DESSERTS	18 MIN	5-33 MIN

1. Prepare desired food and place into cooking pot.
2. Secure the Lid (2) onto the unit, turn it Counter-clockwise to lock it properly in place.
3. Make sure the Pressure Limiting Valve (3) is set to the "Airtight" position.
4. Plug the power cord into a 120V power outlet.
5. The LED screen will display **00 00**.
6. Choose the desired **MENU BUTTON**. The Default Cook Time will display for the selected setting. For example, if **RICE** is selected, the display will show **P12**. **There is no need to press any other button.**
7. The **RICE** Indicator will blink five times and then illuminate solid once it begins operation.
  - While the unit is building up pressure the LED display will show a scrolling **00:12**. **The unit may take between 5-20 minutes to build up pressure depending on weight of contents inside.**

### NOTES & TIPS #4:

When programming to pressure cook, the LED screen will not begin to countdown until the pressure has built up to capacity. Once it begins to pressure cook, the LED display will show a **solid 00:XX** (XX being the number of minutes you have programmed to cook).

# OPERATING INSTRUCTIONS (CONT.)

8. The pressure cooker will begin to operate based on a cooking time of 12 minutes. When proper pressure is achieved, the display will show **00:12** and the cooking time will begin to countdown. (The time displayed will depend on the selected **MENU BUTTON** and the **DEFAULT COOK TIMES CHART** on page 13).
  9. When the unit has pressurized, it will begin to pressure-cook the food. You may hear quiet hissing or sizzling sounds coming from inside of the unit during this time. **\*\*See Notes & Tips #2** if there is steam escaping from the Lid (2) or the Pressure Limiting Valve (3).
  10. When cooking has completed, the pressure cooker will beep 3-times and automatically go to **KEEP WARM**. The display will show **bb** during **KEEP WARM**.
  11. The **KEEP WARM** indicator light will illuminate and the Pressure Cooker will begin naturally releasing the pressure. (See Notes & Tips #6). Depending on the contents inside, natural pressure release may take some time to fully release. As a safety feature, the lid will not open unless all pressure is released. **Do not force the lid open**. Once all pressure has released, the Float Valve (4) should sink and the lid should open easily. If the lid feels tight, please allow additional time for pressure to fully release before attempting to open the lid.
  12. You may also Quick Release the pressure. To use Quick Release, move the Pressure Limiting Valve (3) to the "Exhaust" position to release the pressure until the Float Valve (4) sinks (Figures 17-18).
- **CAUTION: Use an oven mitt or long utensil. Keep hands and face away from Pressure Limiting Valve (3) while in the Exhaust position. Failure to comply may cause serious injury.**

## NOTES & TIPS #5:

When cooking soups or stews with other hearty ingredients such as potatoes or meat, as much as 5 or 6 cups of liquid must be used to prevent ingredients from over-cooking or burning.

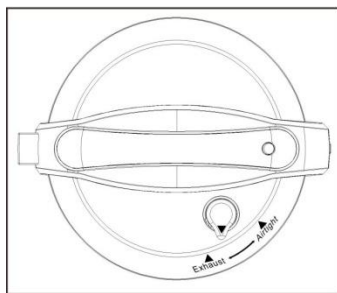

17

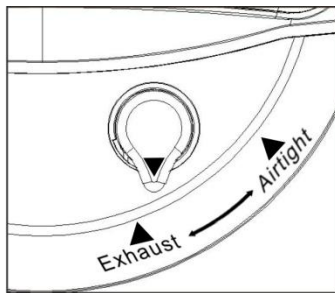

18

13. Always be certain the pressure is released completely before unlocking the lid (2) and opening it.
14. Press **CANCEL** to end operation and remove food to serve immediately or allow the unit to remain in **KEEP WARM** mode. (It is not recommended to keep food warm for over 4-hours).

# OPERATING INSTRUCTIONS (CONT.)

## NOTES & TIPS #6:

- a. **NATURAL RELEASE** is recommended when cooking foods that will not have the tendency to overcook such as Potatoes, Beans, Soups & Stews. During the Natural Release time period, the pressure cooker may still be heated and cooking the food slightly. In Natural Release, do not move the **Pressure Limiting Valve (3)** to EXHAUST immediately after cooking. Depending on the contents inside, Natural Release may take some time to fully release. Gently tap the **Valve (3)** using an oven mitt or utensil. If it is loose and turns easily and no steam is released from the **Valve (3)**, then all pressure has been released. As a safety feature, the lid will not open unless all pressure is released. **Do not force the lid open.** Once all pressure has released, the **Float Valve (4)** should sink and the lid should open easily. If the lid feels tight, please allow additional time for pressure to fully release before attempting to open the lid.
- b. **QUICK RELEASE** is recommended when cooking foods that you wish to be Medium or Medium-Rare such as Beef Roasts or Lamb. This will release the pressure quickly and prevent the food from over-cooking.
- **CAUTION: Use an oven mitt or long utensil. Keep hands and face away from Pressure Limiting Valve (3) while in the Exhaust position. Failure to comply may cause serious injury.**

## HOW TO USE THE “PRESSURE COOK TIME” BUTTON:

Setting your own cook time is ideal for cooking meat or poultry that weighs more than 3-pounds. It is also suggested for slow-cooking certain recipes that require cooking for more than 30-minutes. The programmed cook time can be set up to 90-minutes.

- The **PRESSURE COOK TIME BUTTON** is used in combination with the **MENU BUTTONS**.
- **TIP:** Check the chart on page 13 for the "Cooking Time Range" for each **MENU BUTTON**.
1. Prepare desired food and place into cooking pot.
  2. Secure the Lid (2) onto the unit, turn it Counter-clockwise to lock it in place properly.
  3. Make sure the Pressure Limiting Valve (3) is set to the "Airtight" position.
  4. Plug the power cord into a 120V power outlet.
  5. The LED screen will display **00 00**.
  6. Press a **MENU BUTTON** and then quickly press the **PRESSURE COOK TIME** button to adjust the cooking time. Each incremental press of the button increases the cooking time by 1 minute. Hold the button down for rapid increase of cooking time.
    - Example 1: If you first press **BEANS** and then quickly press the **PRESSURE COOK TIME** button, you will be able to set the cook time between 10 – 90 minutes.
    - Example 2: If you first press **DESSERTS** and then quickly press the **PRESSURE COOK TIME** button, you will be able to set the cook time between 5 – 33 minutes.
    - You can do this using all of the **MENU BUTTONS** except **RICE**.
  7. Press the **PRESSURE COOK TIME** button past the maximum time allowed to start over at the beginning of the "Cooking Time Range" for each **MENU BUTTON**.

(continued on next page)



# OPERATING INSTRUCTIONS (CONT.)

- **TIP:** If you cannot adjust the **PRESSURE COOK TIME**, it is because too much time has passed since you first pressed the **PRESSURE COOK TIME BUTTON**. Cancel the cooking process. Press desired **MENU BUTTON** and then quickly press the **PRESSURE COOK TIME BUTTON** continuously until you've reached the desired cook time.
- 8. **There is no need to press any other button.**
- 9. The Indicator Light will blink five times and then illuminate solid when it begins operation.
- 8. When proper pressure is achieved, the display will show the desired cook time and the cooking time will begin counting down.
- 9. When cooking has completed, the pressure cooker will beep 3-times and automatically go to **KEEP WARM**. The display will show **bb** during **KEEP WARM**.
- 10. The **KEEP WARM** indicator light will illuminate and the Pressure Cooker will begin naturally releasing the pressure. (See Notes & Tips #6).

## HOW TO USE THE DELAY TIMER:

If you wish to Program your pressure cooker to automatically cook prepared food at a later time, you can program the pressure cooker to delay cooking by up to 24-hours. (\*See Notes & Tips #7). This setting is used in combination with the **MENU BUTTON SELECTIONS** in the chart shown on page 13 and with the **PRESSURE COOK TIME BUTTON**.

1. Prepare desired food and place into cooking pot.
2. Secure the Lid (2) onto the unit, turn it Counter-clockwise to lock it in place.
3. Make sure the Pressure Limiting Valve (3) is set to the "Airtight" position.
4. Plug the power cord into a 120V power outlet.
5. The LED screen will display **00 00**.
6. Press the **DELAY TIMER** button. The LED screen will show **0:30** which is equal to 30 minutes of delay time. Press it again for each additional 0.5-hour or hold for rapid increase. The maximum Delay period is 24-hours in half-hour increments. Pressing the delay timer button again after reaching the 24-hour setting will automatically reset the delay timer to zero. (The time that displays on the LED screen shows how long the user wants the unit to wait before the cooking process begins.)
7. EX: If you wish to program the pressure cooker to automatically turn on in 3-hours, press the **DELAY TIMER** button until the LED screen displays **3:00**.
8. After programming a Delay time of 3 hours, choose a **MENU BUTTON** or customize your **PRESSURE COOK TIME**.

## MENU SELECT BUTTONS:

- Select one of the 8 Pre-Set **MENU BUTTONS**.
- Once you have selected your desired function, the pressure cooker will count down the delay time of 3 hours and then start cooking.

(continued on next page)

# OPERATING INSTRUCTIONS (CONT.)

## PRESSURE COOK TIME:

- Press a **MENU BUTTON** and then quickly press the **PRESSURE COOK TIME** button to reach the desired cook time. Follow the instructions under "How to use the PRESSURE COOK TIME button."
  - Once the desired **DELAY TIME** and **PRESSURE COOK TIME** are selected, the **DELAY TIMER** and the **MENU BUTTON** will illuminate and the unit will begin counting down the delayed time before cooking begins.
9. Once the pressure cooker completes its countdown, the unit will begin to pressurize and follow the cooking sequence for the chosen **PRESSURE COOK TIME** selection.
  10. When cooking is complete, the pressure cooker will keep 3-times and automatically go to **KEEP WARM**. The display will show **bb** during **KEEP WARM**.
  11. The **KEEP WARM** indicator light will illuminate. This indicates the Pressure Cooker is Naturally Releasing the pressure. (See Notes & Tips #6).

## **NOTES & TIPS #7:**

When the pressure cooker enters into the Pressurized Sequence, the LED screen will display a solid 00:XX (XX being the number of minutes you have programmed to cook).

For foods with a high volume of liquid (Stews, soups, porridges, etc.) **IT IS NOT RECOMMEND TO USE QUICK RELEASE**. This is to avoid liquid splatter from the ventilation in the Pressure Limiting Valve (3).

Use **NATURAL RELEASE**: User should wait for the temperature to drop and the Float Valve to sink on its own prior to opening the lid.

**CAUTION: It is not recommended to use the Delay Timer function to cook foods that may spoil. Leaving raw foods inside the pressure cooker for long periods of time prior to cooking may result in the food spoiling. Cook food that can be left out such as rice, beans, grains or other foods that will not spoil.**

## HOW TO **BROWN/SAUTÉ** WITH YOUR PRESSURE COOKER:

Before Pressure Cooking, most recipes will benefit from the golden color, richer flavors and moist results gained from Browning/Sautéing.

To Brown or Sauté your meats or vegetables prior to pressure cooking:

1. Remove lid (2) and plug in the pressure cooker.
2. Press the **BROWN/SAUTÉ** button. Press the **PRESSURE COOK TIME** button to adjust the time. There is no need to press any other button.
3. Add oil or butter as directed in your recipe and then place food into the Inner Pot (6).
4. Stir or turn food as needed until desired color and consistency is reached.
5. Press the **Keep Warm/Cancel** button if you want to cancel the **BROWNING** function before the timer finishes counting down.
  - Allow the unit to rest 2-3 minutes after cancelling the **BROWNING** function before beginning to pressure cook.
6. Continue your recipe by adding liquid, attaching lid (2) and selecting desired program/cook time.

# OPERATING INSTRUCTIONS (CONT.)

## HOW TO USE THE **KEEP WARM** FUNCTION:

Food can be prepared at an earlier time and kept warm inside the pressure cooker using the **KEEP WARM** function. Food should not be kept warm for more than 4-hours. Additional time may cause a change in flavor, appearance and cause food to spoil.

1. Prepare desired food and place into cooking pot.
2. Secure the Lid (2) onto the unit, turn it Counter-clockwise to lock it in place properly.
3. Plug the power cord into a 120V power outlet.
4. The LED screen will display **00 00**.
5. Press the **KEEP WARM/CANCEL** button once. The **KEEP WARM/CANCEL** indicator light will illuminate solid and the display will read **bb**. It is recommended to set the Pressure Limiting Valve (3) to "Exhaust" at this time.
6. To cancel, simply press the **KEEP WARM/CANCEL** button again until indicator light is no longer illuminated.
7. Remove food and serve.
8. Unplug power cord and allow to cool completely before dismantling and cleaning.

## HOW TO USE THE **SLOW COOK** BUTTON:

1. Prepare desired food and place into Inner Pot (6).
2. Secure the Lid (2) onto the unit, turn it clockwise to lock into place.
3. Set the Pressure Limiting Valve (3) to the "Exhaust" position.
4. Plug the power cord into a 120V power outlet.
5. The LED screen will display **00 00**.
6. Press the **SLOW COOK** button once and the display will show the default **SLOW COOK** time of **06:00**. **Quickly** continue to press the **SLOW COOK** button to increase cook time in increments of 30 minutes.
6. Hold the **SLOW COOK** button down for rapid increase of cooking time.
  - **NOTE:** The longest **SLOW COOK** time allowed is 9.5 hours.
  - **TIP:** If you cannot adjust the **SLOW COOK** time, it is because too much time has passed since you first pressed the **SLOW COOK** BUTTON. Cancel the cooking process. Then press the **SLOW COOK** button continually until you've reached the desired cook time.
7. **There is no need to press any other button.**
8. The **SLOW COOK** indicator will blink five times and then illuminate solid once it begins operation.
  - **The unit may take between 5~20 minutes to reach temperature before beginning count down.**
9. When cooking is complete, the cooker will beep 3-times and automatically go to **KEEP WARM**. The display will show **bb** during **KEEP WARM**.
10. The **KEEP WARM** indicator light will illuminate. Press **CANCEL** to end the operation.

# OPERATING INSTRUCTIONS (CONT.)

## HOW TO USE THE **STEAM** BUTTON:

Place wire rack into Inner Pot. A stainless steel wire rack or trivet no larger than 8.25" in diameter is recommended for use with this pressure cooker.

1. Place heat resistant dish or container on top of wire rack.
2. Add water to a level just below the top of the rack.
3. Place food in heat resistant container on the rack. Do not fill pot more than 2/3 full with food. If steaming rice, put rice in an 8 inch or smaller bowl and place on rack.
4. Secure the Lid onto the unit, turn it Counter-clockwise to lock it in place properly.

➤ The **STEAM** function can be used w/ pressure (turn Pressure Limiting Valve to AIRTIGHT), or w/o pressure (turn Pressure Limiting Valve to EXHAUST).

5. Press the **STEAM** button, the display will show **P5** as the default cook time.
  6. Set the desired cooking time by pressing the **PRESSURE COOK TIME** button once for each additional minute or hold for rapid increase. The longest steam time allowed is 25 minutes.
  7. Once desired **STEAM** time is displayed, **there is no need to press any other button.**
  10. The Indicator Light will blink five times and then illuminate solid when it begins operation.
  9. When proper pressure is achieved, the display will show the desired cook time and the cooking time will begin counting down.
  11. When cooking has completed, the pressure cooker will beep 3-times and automatically go to **KEEP WARM**. The display will show **bb** during **KEEP WARM**.
  12. The **KEEP WARM** indicator light will illuminate and the Pressure Cooker will begin naturally releasing the pressure. (See Notes & Tips #6).
  8. Press the **CANCEL** button to end operation.
- **CAUTION! Never put your face or hands directly over the cooker when removing lid, escaping steam can cause serious burn injury.**

## HOW TO COOK WITH **FROZEN** FOODS:

Cooking frozen food inside a pressure cooker is quick and easy but has certain restrictions. Only cook individual cuts of frozen meats that are up to 1 inch thick, the cooking time does not need to be altered. Pressure will not be achieved until the internal temperature has reached a preset level. If the recipe states the meat should be cooked for 10 minutes after pressure has been achieved, it will still be the same, but it will take longer to reach the required pressure point.

It is not recommended to pressure cook larger cuts of frozen meats such as a whole roast, a block of frozen ground meat or a whole chicken. Larger cuts will require increased cooking times of up to one third more, and the results may not be the same when compared to meats that were thawed (or at least partially thawed) and browned before cooking.

# OPERATING INSTRUCTIONS (CONT.)

## HOW TO USE THE PRESSURE COOKER FOR **CANNING**:

It is recommended to purchase a separate instructional book that is specific to Canning. These books can be purchased at a local book store. This pressure cooker can be used to do basic pressure canning and the water-bath method. Low-Acidic fruits and vegetables and High-Acidic fruits and vegetables are recommended. It is not recommended to can foods such as meat or seafood products in this unit. It is not recommended to use this pressure cooker for canning at high or low altitudes.

Before using this unit for canning purposes, check with the UDSA for food preservation guidelines or read the publications listed at [http://www.uga.edu/nchfp/publications/publications\\_usda.html](http://www.uga.edu/nchfp/publications/publications_usda.html).

1. Always use canning supplies specifically manufactured for canning purposes. It is recommended to use mason jars that are 32-ounces or smaller. Do not stack jars on top of each other.
2. Always inspect your canning supplies to ensure proper function and safety. Avoid using jars with chips, nicks, cracks or other imperfections in the glass, rims or lids.
3. Wash jars thoroughly in hot water according to manufacturer's instructions.
4. Prepare food and fill mason jars and seal according to manufacturer's instructions.
5. Always make sure there is 1-inch of headspace in the jars.
6. Use a thin utensil to release any trapped air between the food and the jar by pressing food firmly to the sides to dislodge any air bubbles.
7. Set jar lids onto the jar and screw on the outer rings until tight, then unscrew ¼ turn.
8. Place jars into the inner pot.
9. If desired, use clean dish towels to tuck around the jars to prevent them from touching each other or the sides of the inner pot.
10. Fill inner pot with 6-cups of water. (Certain canning recipes may require a different amount of water.)
11. Secure the lid onto the pressure cooker, turn it Counter-clockwise to lock it in place properly.
12. Make sure the Pressure Limiting Valve (3) is set to the "Airtight" position.
13. Plug the power cord into a 120V power outlet.
14. Follow canning recipe for the type of food you are canning and program the **Pressure Cook Time (under a specific Menu Button)** for the specified time frame for the size of jars and type of food recipe you are using by following the directions under **How to use the Menu Buttons** and **How to use Set Pressure Cook Time** in this manual.
15. When the unit has reached optimum pressure, it will begin to pressure-seal the mason jars. The programmed time will begin to count down until it reaches zero.
16. When time has expired, the pressure cooker will beep 3-times and automatically go to Keep Warm.
17. The Keep Warm indicator light will illuminate. This indicates the Pressure Cooker is

## OPERATING INSTRUCTIONS (CONT.)

Naturally Releasing the pressure (See Notes & Tips #6).

18. Open lid once pressure has completely released.
19. Carefully remove jars using special canning utensils or tools. **CAUTION: Jars are hot!**
20. Set jars on a towel or cooling rack and allow to cool completely in a draft-free location.
21. Follow recipe instructions on cooling and storage.

### NOTES & TIPS #8:

While the jars are cooling, a small “click” sound will come from the lids to indicate the lids are sealing properly.

After approximately one hour, check to be sure the flat lids have obtained a good seal by pressing down with your thumb; the lid should remain stiff with no movement.

If you have not achieved a good seal within 2 hours, the canning did not work properly and the ingredients will need to be refrigerated and used within 3 days or frozen in a freezer container.

### NOTES & TIPS #9:

If recipes require the use of a trivet, riser (wire rack), foil, or heat-resistant/pressure-resistant oven-safe cookware, you may use these accessories in this pressure cooker.

If you do not have a wire rack that will fit, simply use 3-4 mason jar lids or regular jar lids for a simple 1-inch riser.

# HELPFUL TIPS

- Read this manual thoroughly and follow all instructions.
- Be familiar with the recipe and have all ingredients prepped before you begin.
- Be sure the lid is secured and locked properly before beginning.
- You may wish to brown some meats before cooking with other ingredients. To do so, follow instructions on page 17.
- Cut foods into equal-sized pieces to promote even cooking. In recipes that call for multiple ingredients, cut those that cook more quickly into larger pieces and those that cook more slowly into smaller pieces.
- Many different cooking liquids can be used in a pressure cooker: wine, beer, bouillon, fruit juices, water, broth and more.
- After becoming familiar with your pressure cooker, you can readily adapt conventional recipes to be used with a pressure cooker. In general, cut cooking times by two thirds. The amount of liquid used may also have to be reduced because there is very little evaporation in the pressure cooker. Reduce the required liquid so there is only about 1/2 cup more than desired in the finished product. Remember, however, there must always be some liquid in the pressure cooker to produce the necessary steam. Try using this rule; 1 cup of liquid for the first 15 minutes of pressure cooking then 1/3 cup of liquid for each subsequent 15 minutes. This can still vary, so if your unit will not build pressure you will have to add more liquid until it is able to build pressure. (See 3rd down in Troubleshooting).
- Since flavors are more intense, reduce the amounts of herbs and seasonings when adapting from conventional recipes. Fresh herbs are better for pressure cooking than dried.
- In general, pressure cookers cook foods in about 1/3 the time of conventional cooking methods.
- Increase cooking times by about 10% when cooking in high altitudes of over 3,500 feet.
- If you wish to cook food in less time than the pre-programmed amount, observe the timer and press CANCEL when desired cooking time has elapsed.
- Always check to make sure your gasket and float valve are clean, unobstructed and in good working order.
- When cooking under pressure, never fill above the fill line of the inner pot markings.
- If you are making soup and you are at the fill line, do not release pressure manually because hot liquid could spray out.
- Never attempt to open lid while under pressure and while float valve (4) is still up!!! Always open pressure cooker with the lid facing away from you.
- When manually releasing pressure, evaporation of some liquid may occur (i.e. when making rice or risotto). This is normal, but caution must be used to prevent injury.

# HOW TO CLEAN YOUR PRESSURE COOKER

1. Always make sure the Pressure Cooker is unplugged, depressurized and completely cooled down before dismantling.
  2. Use a non-abrasive sponge or damp wash cloth to clean the exterior of the outer body (13) and the exterior surface of the pressure cooker. **NEVER** immerse the pressure cooker in any liquids.
  3. Remove the Condensation Cup (12) and rinse it thoroughly and let dry. Clean the Upper Ring (9) with a damp sponge or wash cloth.
  4. Clean the Lid (2) with warm soapy water, including the Rubber Seal Ring (18), Pressure Limiting Valve (3), Filter (17), Vent, Float Valve (5) and let dry thoroughly.
    - The Pressure Limiting Valve (3) pops off easily by gently reaching underneath it and gently prying upwards. Be careful not to damage the thin wire spring under it.
    - On the underside of the lid below the Pressure Limiting Valve (3), is a small metal filter cap which can be easily removed to clean.
  5. Let parts dry completely before reassembling.
  6. Wash the Inner Pot (6) and Wire Rack (20) with a non-abrasive sponge and allow to air dry or use a towel. It is not recommended to use any type of scouring pad that can scratch the non-stick surface of the Inner Pot (6).
  7. Clean the Pressure Limiting Valve (3) and the holes with a small brush to ensure smooth flow of steam during the release cycle.
  8. Store the inner pot inside of the Pressure Cooker. Store Pressure Cooker in a cool, dry location.
- **NOTE:** Any servicing required shall be performed by an authorized service representative or from the original manufacturer or distributor.

## How to Clean the Filter:

If you wish to clean the filter (17), you may remove it by pulling vertically. To re-attach, simply line up the filter (17) and press down to secure the filter (Figure 23).

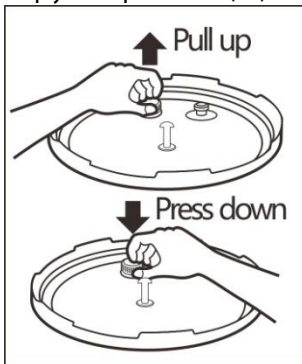

23



# TROUBLESHOOTING

PROBLEM	SOLUTION
<p>Is the Airtight/Exhaust Pressure Limiting Valve (3) on the top of the lid supposed to be loose?</p>	<p>If you are not cooking or using the unit, the Valve (3) will be loose. It will turn 360 degrees and may even come off if you pull on it. Once you start using the pressure cooker and the pressure has built up, and the Valve is set to "Airtight" properly, it will resemble a bobble head.</p> <p>Sometimes during cooking and pressurizing, steam may escape from the Valve. It indicates the Valve is not seated properly/securely. Simply use tongs or similar utensil and gently/carefully adjust it so it is seated properly.</p>
<p>When I choose a Menu Button (ex: MEAT &amp; CHICKEN), nothing happens? What's wrong?</p>	<p>Nothing is wrong. Make sure the Valve (3) on top is set to Airtight and the Lid (2) is locked securely. Once you have selected the Menu Button, simply leave the unit alone and it will start to heat up and build up pressure.</p> <p>Once the unit has built up enough pressure, the display will change to a countdown timer that displays your desired cooking time of the Menu Button you selected. This is the time the unit will start cooking the food. Pressurizing can take anywhere from 5 minutes up to 20 minutes depending on the quantity of food you are cooking.</p> <p>The unit will then start to cool down and de-pressurize on its own. It will beep 3 times. The countdown timer will change to bb and the Keep Warm light will illuminate.</p> <p>During this time, the food inside is still cooking. Depending on if you want your food to be cooked longer, you can allow the unit to naturally release the pressure by letting the unit sit. (Some meats will keep cooking once the pressure is released, so if you prefer your meat to be Medium or Medium-Rare, we suggest the quick release.)</p> <p>Once the pressure has completely released, the floating valve (4) will drop down. You can unlock the lid and open to check on your food.</p>
<p>When I set the pressure using the Preset Menu Buttons, it will begin to build pressure and heat up, but in about 5-minutes the unit beeps 3 times and goes to Keep Warm and my food did not cook completely. What is happening?</p>	<p>The unit is detecting that not enough liquid has been added to your recipe. The pressure cooker has an automatic over-heat protection sensor that will automatically set itself to OFF or Keep Warm when it detects that not enough liquid is present so that it does not over-heat. Make sure all pressure is released, open the lid and add in increments of 1/2 cups of liquid until the unit will properly build up pressure and cook.</p> <p>The unit is detecting that there is a leak in the pressure and that it is not sealed properly. Firmly push down on the lid to help the seal form or release any built up pressure and safely remove the lid to check the unit thoroughly. Make sure the rubber gasket ring is in place, the lid is securely locked, and that the Valve on top of the lid is set to the "Airtight" position. Reset the unit by unplugging it. Wait 10-seconds and plug it back in. Program the unit again.</p> <p>Both of the above solutions will cause some liquid to have evaporated and it is recommended to add back in any liquid that has evaporated otherwise you will keep encountering the same issue.</p>

PROBLEM	SOLUTION
<p>Steam is being released around the rim of the lid during the pressurizing sequence. How do I fix this?</p>	<p>See Notes &amp; Tips #2.</p> <p>The Rubber Seal Ring (18) did not make a proper seal. Cancel all the functions. Exhaust any remaining pressure and steam. Open the lid and remove it entirely. Check the Rubber Sealing Ring to make sure it is positioned properly. Rub a wet cloth along it to make sure it is clean of debris and it is smooth. Re-assemble the lid, lock it securely in place and restart the cooking process.</p>
<p>Steam is being released from the Pressure Limiting Valve (3) during the pressurizing sequence. How do I fix this?</p>	<p>See Notes &amp; Tips #2.</p> <p>The Valve (3) may not be positioned properly. Simply use tongs or similar utensil or oven mitt and carefully adjust it so it is seated properly. If the steam continues to release, you may need to Cancel all the functions. Exhaust any remaining pressure and steam. Remove the Pressure Limiting Valve and check the thin wire spring on the underside of it. Make sure it is not bent or loose. If steam still continues to escape, the Valve may be faulty and replacement or repair may be necessary. Please contact the manufacturer.</p>
<p>Pressurized Steam is being quietly released from the Floating Valve (4) area during the pressurizing sequence. How do I fix this?</p>	<p>This may happen during the initial start-up of the Pressurizing Sequence. Simply use tongs or similar utensil or oven mitt and carefully adjust it so it is seated properly. This will help settle the lid and all the valves properly. The pressure will quickly push up on the Floating Valve and seal it properly then finish the pressurizing sequence.</p>
<p>My food is finished cooking and all the pressure is released, but I cannot unlock and open my lid. What is stuck?</p>	<p>Make sure all the pressure and steam has been completely released. Make sure the small Floating Valve (4) is no longer in the up position. It may be stuck in the UP position, simply tap the lid slightly to make it go back down. Then turn the lid clockwise to unlock the lid. If it is still stuck, unplugging the unit may help.</p>
<p>What is the clear, round plastic part that came with my pressure cooker?</p>	<p>It is the Condensation Cup: Refer to part (12) under Parts Identification within this manual to attach the condensation cup to the side of the pressure cooker. This catches the water and steam that drips off the lid when the lid is opened in the upright position.</p>
<p>I've programmed the pressure cooker to cook but it's just sitting there and nothing appears to be happening.</p>	<p>The unit is still building up pressure. Normally this takes between 5-20 minutes. However, if you are cooking a very full pot of food, the pressure build up time can take up to 30 minutes.</p>
<p>The unit is DEAD or has NO POWER.</p>	<p>The fuse in the unit has shorted out. This happens if the unit is cooked without enough liquid in the inner pot or if there is too much electrical current going to the cooker. Please contact customer service at (800) 365-6133 ext. 120/107/105 for a replacement fuse.</p>
<p>The LED display shows E4 error.</p>	<p>Unplug the power cord from the wall outlet. Wait approximately 15 minutes. Plug the power cord back into the wall outlet. Press "CANCEL" button on the pressure cooker. Select cooking process to begin cooking. If problem persists, contact customer service at (800) 365-6133 ext. 120/107/105 for a replacement thermofuse.</p>
<p>My food is burned at the bottom of the inner pot.</p>	<p>There is not enough liquid in the inner pot. Add more liquid to your inner pot contents.</p>

# COOKING TIME CHART

Courtesy of [www.healthfoods.com](http://www.healthfoods.com)

Please note that all the below information is for your reference only and can be adjusted according to the user's preference.

## Meat/Poultry

- Always cook meat or poultry with at least 1-3 cups of liquid. If the cooking time exceeds 15 minutes, use 2 cups of liquid. If weight of meat or poultry is 3lbs, use 3 cups of liquid. Preserved or salted meats should be immersed in water.
- Cooking times for meat and poultry may vary according to the quality and quantity of meat or poultry being cooked.
- Unless indicated. The cooking times given below are for 3 pounds of meat or poultry unless noted otherwise. Additionally, the denser the cut, the longer the cooking time should be.

Type of Meat	Approximate Cooking Minutes	Pressure Release
Beef/Veal, roast or brisket	38-42	Quick Release
Beef Meatloaf, 2 lbs.	13-18 or use the Meat Button	Quick Release
Beef, meatballs, 1-2 lbs.	7-12 or use the Meat Button	Natural Release
Beef, Corned	55-65	Natural Release
Pork, roast	43-47	Natural Release
Pork, ribs, 2 lbs.	18 or use the Meat Button	Quick Release
Pork, ham shank	25-28	Natural Release
Leg of Lamb	42-45	Natural Release
Chicken, whole, 2-3 lbs.	15-18 or use the Meat Button	Quick Release
Chicken, pieces, 2-3 lbs.	12-15 or use the Meat Button	Quick Release
Cornish Hens, two	12-15 or use the Meat Button	Quick Release
Meat/Poultry soup/stock	15-20 or use the Meat Button	Quick Release

## Seafood

- Cooking times may vary according to the type of seafood being cooked.
- Cook seafood on a cooking rack with a trivet on the bottom of the pot (if available), and add at least 3/4 cup of liquid. Lightly grease cooking rack with vegetable oil when cooking fish.

Type of Seafood	Approximate Cooking Minutes	Pressure Release
Clams	3-5	Quick Release
Crabs	3-5	Quick Release
Lobster, 1 1/2 - 2 lbs.	3-5	Natural Release
Mussels	3-5	Quick Release
Shrimp	2-3	Quick Release
Fish, whole, gutted	7-8	Quick Release
Fish, Soup or Stock	7-8	Quick Release

## Vegetables

- Always cook with at least 1-2 cups of liquid.
- Add 1-2 additional minutes to cooking time when preparing frozen vegetables.
- Use the quick-release release method at the end of cooking cycle so vegetables will not become soggy. (Below chart is for quantity approximately half a pot).

Type of Vegetable	Approximate Cooking Minutes	Pressure Release
Asparagus, thick whole	2-5	Quick Release
Asparagus, thin whole	1-2	Quick Release
Beans, fava, shelled	5	Quick Release
Beans, green, whole	4-5	Quick Release
Beans, lima, shelled	3	Quick Release
Beets, small, whole	2-3	Quick Release
Beets, large whole	23	Quick Release
Beets, 1-inch slices	5	Quick Release
Broccoli, flowerets	3	Quick Release
Brussel sprouts, whole	5	Quick Release
Carrots, 1-inch chunks	5	Quick Release
Carrots, 1/4-inch slices	1-2	Quick Release
Cauliflower, flowerets	3-5	Quick Release
Corn on-the-cob (4-6)	4	Quick Release
Escarole, coarsely chopped	2-3	Quick Release
Kale, coarsely chopped	2-3	Quick Release
Okra, small pods	3-5	Quick Release
Onions, whole	3	Quick Release
Potatoes, 1 1/2-inch chunks	7	Quick Release
Potatoes, new, small whole	6	Quick Release
Potatoes, sweet and yams, whole, medium	10-12	Quick Release
Potatoes, sweet and yams, 2" chunks	7-8	Quick Release
Spinach, fresh, coarsely chopped	3	Quick Release
Squash, acorn, halved	8	Quick Release
Squash, butternut, 1-inch chunks	5	Quick Release
Squash, summer, zucchini or yellow, 1/2-inch slices	6	Quick Release
Turnips, small quartered	4	Quick Release
Turnips, 1 1/2 inch chunks	4	Quick Release

**\*Split peas and rhubarb can foam, froth, and sputter, and can clog the pressure release device (steam vent). These foods should not be cooked in a pressure cooker.**

## Dried Beans and Other Legumes

- Place beans or legumes in pressure cooker. Add 3 cups of water for each cup of beans or legumes.
- Add 1 tablespoon of vegetable oil for each cup of water to cut down on foaming. Do not add salt until after cooking.
- Let pressure drop naturally after cooking.
- Cooking times may vary according to the quality of the beans or other legumes. If still hard after recommended cooking times, continue cooking uncovered. Add additional water, if necessary. (Below chart is for quantity approximately half a pot).

Type of Legume	Approximate Cooking Minutes	Pressure Setting
Azuki	7-8	Natural Release
Black Beans	10-12	Natural Release
Black Eyed Peas	11-12	Natural Release
Chick Peas (garbanzo)	11-13	Natural Release
Gandules (pigeon peas)	8-10	Natural Release
Great Northern	10-14	Natural Release
Kidney Beans, Red	12-14	Natural Release
Lentils, green	10-12	Natural Release
Lentils, soup	8-10	Natural Release
Lentils, red	10-15	Natural Release
Lima Beans	7-8	Natural Release

**\* Applesauce and cranberries, can foam, froth, and sputter, and can clog the pressure release device (steam vent). These foods should not be cooked in a pressure cooker.**

## Grains

Before cooking, soak certain grains, such as wheat berries and pearl barley in four times their volume of lukewarm water for at least four (4) hours or overnight if required. Do not add salt to water, since it may toughen the grains and inhibit hydration.

- Do not soak rice.
- Rinse under lukewarm water (this also applies to rice)
- Cook each cup of grain in the amount of water specified.

Type of Grain	Approximate Cooking Minutes	Pressure Setting
Rice, basmati – 1 1/2 cups	7-8	Natural Release
Rice, converted – 1 1/2 cups	7-8	Natural Release
Rice, long grain – 1 1/2 cups	7-8	Natural Release
Rice, brown – 1 1/2 cups	17-22	Natural Release
Rice, wild – 3 cups	25-27	Natural Release
Wheat, berries – 3 cups	1	Natural Release

**\* Pearl barley, oatmeal or other cereals can foam, froth, and sputter, and can clog the pressure release device (steam vent). These foods should not be cooked in a pressure cooker.**

### Meat/Poultry (Larger Cuts)

- Always cook meat or poultry with at least 1-3 cups of liquid. If the cooking time exceeds 15 minutes, use 2 cups of liquid. If weight of meat or poultry is 3lbs, use 3 cups of liquid. Preserved or salted meats should be immersed in water.
- Cooking times for meat and poultry may vary according to the quality and quantity of meat or poultry being cooked.

Category	Meat	Pressure Cooker Cook Times (Approx)	
Beef, fresh	rib roast, bone in (4 to 6 pounds)	42-80 minutes cook time	
	rib roast, boneless, rolled (4 to 6 pounds)		
	round or rump roast (2 ½ to 4 pounds)	30-45 minutes cook time	
	4 to 8 pounds (breast)	30-80 minutes cook time	
	8 to 12 pounds	35 to 45 minutes cook time	
Chicken, fresh	whole roasting hen (5 to 7 pounds)	25 - 35 minutes cook time	
	breast, halves, bone-in (6 to 8 ounces)	8-15 minutes cook time or press Chicken button	
	breast, halves, boneless (4 ounces)		
	legs or thighs (4 to 8 ounces)	8-20 minutes cook time or press Chicken button	
	Pork, fresh	loin roast, bone-in or boneless (2 to 5 pounds)	25 - 50 minutes cook time
		crown roast (4 to 6 pounds)	35 - 70 minutes cook time
		tenderloin (½ to 1 ½ pounds)	8-15 minutes cook time
Ham, smoked		fresh, cook-before-eating, bone-in, half (5 to 7 pounds)	45 - 70 minutes cook time
		fully cooked, bone-in, half (5 to 7 pounds)	35 - 60 minutes cook time
	fully cooked, spiral cut, whole or half (7 to 9 pounds)	50 - 85 minutes cook time	

*Recipes on this page are courtesy of Joelle Hunter.*

**MACARONI N' CHEESE**

SERVES 8

***Ingredients***

- |                             |   |
|-----------------------------|---|
| 2 Tbsp butter               | 3 pounds elbow noodles (or your favorite small pasta) |
| 2 shallots, minced          | 1 loaf original Velveeta, cut into cubes              |
| 12 cups water               | 2 cups shredded mozzarella cheese                     |
| 2 Tbsp seasoned salt        | 2 cups shredded cheddar cheese                        |
| 1 Tbsp Worcestershire sauce | 1/2 jar diced pickled jalapeños                       |
| 1 Tbsp dry mustard          |   |

***Directions***

Follow the "**BROWNING**" instructions in this manual: Melt butter and sauté shallots for 2-3 minutes. Cancel "**BROWNING**." Add water, salt, Worcestershire sauce, dry mustard & pasta and cook under pressure for 1 minute. Release pressure, open lid and add cheeses & jalapeños; stir well. Close lid and let cheese melt for 2-3 minutes, then stir again. (For extra creamy "TV" Mac & cheese, stir in 2 cups whole milk, half & half or heavy cream at the end).

Recipes are courtesy of [www.recipezaar.com](http://www.recipezaar.com) and [www.fastcooking.ca](http://www.fastcooking.ca).

Please note that all of the information is for your reference only and can be adjusted according to the user's preference.

## **BEEF IN PEPPER SAUCE**

SERVES 4

### *Ingredients*

#### **Pepper Sauce**

1 red bell pepper or green bell pepper  
 1/2 cup baby carrot  
 1 (8 ounce) can tomato sauce (1 tbsp to be use later)  
 2 garlic cloves  
 2 teaspoons ground ginger  
 1 teaspoon turmeric

1 teaspoon salt  
 1/2 teaspoon black pepper  
 1/2-1 teaspoon cayenne pepper (depends on how spicy you like it)  
 1/2 teaspoon ground cardamom  
 2 tablespoons olive oil

2 lbs boneless sirloin steaks, cut into strips  
 salt & pepper  
 1 cup water  
 1/2 teaspoon paprika

1/2 teaspoon cumin  
 1/2-1 onions, sliced  
 1 green bell pepper, sliced

### *Directions*

- Remove 1 tablespoon of tomato sauce from the can to be used later. Blend the ingredients for the pepper sauce (green pepper through cardamom) in a food processor until there are no chunks left. Set aside.
- Follow the "**BROWNING**" instructions in this manual: add enough olive oil, sprinkle the beef with salt & pepper then brown in the cooker without the lid.
- Once browned, cancel "**BROWNING**" and add water, reserved tomato sauce, paprika & cumin to the beef. Close and lock the pressure cooker lid. Adjust the pressure valve on top to Airtight and press the **MEAT & CHICKEN** function switch.
- When the pressure cooker has finished the cooking cycle, release the pressure by carefully setting the valve to Exhaust on the top of the lid. Once the pressure has released, the lid can be turned and unlocked.
- Add the pepper mixture, sliced onions & green peppers to the meat and sauce, close and lock lid and press the **MEAT & CHICKEN** function again.
- When the pressure cooker has finished the cooking cycle, release the pressure by carefully setting the valve to Exhaust on the top of the lid. Once all the pressure has released, the lid can be turned and unlocked.
- Vegetables and meat should be tender. Serve immediately over white rice if desired.



## CHICKEN PICCATA

SERVES 6

### *Ingredients*

6 chicken breast halves	1 cup pimento stuffed olive, minced
1/2 cup all-purpose flour	1/4 cup sour cream
1/4 cup olive oil	1 tablespoon potato starch or flour
4 shallots	1/4 cup fresh parmesan cheese, grated (1 ounce)
3 garlic cloves, crushed	fontinella cheese, grated
3/4 cup chicken broth	1 lemon, thinly sliced, to garnish
1/3 cup fresh lemon juice	1 teaspoon dried basil
1 tablespoon sherry wine	
2 teaspoons salt	
1/4 teaspoon white pepper	

### *Directions*

- Lightly dust chicken pieces with flour.
- Follow the "**BROWNING**" instructions in this manual: heat oil. Add chicken breasts, two at a time, and sauté in hot oil until brown on all sides. Remove from inner pot and set on a paper towel lined dish.
- Add shallots and garlic to the inner pot and sauté for 3 to 5 minutes, scraping bottom of pan to loosen browned particles remaining from chicken. Stir in broth, lemon juice, sherry, salt, pepper, basil, and olives.
- Cancel "**BROWNING**."
- In the cooking pot, add chicken pieces skin side down back in. Close and lock the pressure cooker lid. Adjust the pressure valve on top to Airtight and press the **MEAT & CHICKEN** function switch.
- When the pressure cooker has finished the cooking cycle, release the pressure by carefully setting the valve to Exhaust on the top of the lid. Once the pressure has released, the lid can be turned and unlocked.
- Stir chicken mixture, then transfer just the chicken to serving platter, and cover to retain heat.
- Whisk sour cream and starch together. Stir into cooking liquid inside the pressure cooker and cook over manual heat 1 minute, stirring constantly.
- Spoon sauce over chicken. Sprinkle with cheese and garnish with lemon slices.

## SPARE RIBS

SERVES 6 -8

### *Ingredients*

1 cup brown sugar	1/4 teaspoon cayenne
1/4 cup soy sauce	1 teaspoon garlic powder
1/2 teaspoon paprika	2 lbs pork ribs
1 tablespoon vinegar	1 cup of chicken/beef stock

### *Directions*

- Prepare sauce ingredients inside cooking pot.
- Divide ribs up evenly so it fits into the pressure cooker.
- Coat each piece thoroughly with the sauce.

- Place ribs into pressure cooker pot after coating with sauce.
- Add the 1 cup of stock to the bottom of pot.
- Close and lock the pressure cooker lid. Adjust the pressure valve on top to Airtight and press the **MEAT & CHICKEN** function switch.
- When the pressure cooker has finished the cooking cycle, release the pressure by carefully setting the valve to Exhaust on the top of the lid. Once the pressure has released, the lid can be turned and unlocked.

## TRADITIONAL MEAT LOAF

SERVES 4

### *Ingredients*

1 1/2 lb mixture of chopped or ground lean beef, pork and veal	1 medium onion, minced	1 garlic clove
Freshly ground pepper	1 egg	
2 slices bread, soaked in water and squeezed dry	2 tablespoons chicken stock	
1 teaspoon salt	1 cup tomato sauce	
2 tablespoons parsley	2 teaspoons Worcestershire sauce	
	1 cup water	
	2 tablespoons olive oil	

### *Directions*

- In a bowl, combine the chopped meat, salt, pepper, bread, parsley, onion, garlic, egg, chicken stock and Worcestershire sauce. Shape into two small loaves. Wrap each in wax paper and chill several hours to firm.
- Follow the "**BROWNING**" instructions in this manual add the oil and brown the loaves well on all sides. Cancel "**BROWNING**." Remove and set on oven-safe dish (not included) that will fit into the pressure cooker.
- Pour out the oil and combine the tomato sauce and water, and season with salt and pepper. Spread the ketchup over the meat loaves and lower the oven-safe dish into the pressure cooker.
- Close and lock the pressure cooker lid. Adjust the pressure valve on top to Airtight and press the **MEAT & CHICKEN** function switch.
- When the pressure cooker has finished the cooking cycle, release the pressure by carefully setting the valve to Exhaust on the top of the lid. Once the pressure has released, the lid can be turned and unlocked.
- Remove dish using a removing utensil/tool. Slice and serve immediately.

## JAMBALAYA

SERVES 4-6

### *Ingredients*

1 tablespoon vegetable oil	1 onion, chopped
1/2 lb boneless skinless chicken breasts, cut into 1" pieces	3 garlic cloves, minced
1/2 lb fully cooked Andouille or Italian sausage, sliced	1 green bell pepper, chopped
1/2 lb uncooked shrimp, peeled and deveined	3 stalks celery, sliced
2 teaspoons Creole seasoning	1 cup long grain rice
1 teaspoon dried thyme leaves	16 oz canned chopped tomatoes, undrained
1/8 teaspoon cayenne pepper	1 cup chicken stock
	3 tablespoons fresh parsley, minced

### *Directions*

- Follow the "**BROWNING**" instructions in this manual, add oil and add chicken, sausage and shrimp. Sprinkle half of the Creole seasoning, half the thyme and half the cayenne. Cook for 3-5 minutes uncovered, stirring frequently, until chicken and shrimp are thoroughly cooked. Remove chicken, sausage and shrimp with a slotted spoon and set aside.
- Add onion, bell pepper, celery and remaining Creole seasoning, thyme and cayenne to skillet and cook for 4-5 minutes, stirring frequently.
- Add chicken, sauce, shrimp and rice, tomatoes with their juice and stock back into the pot. Cancel "**BROWNING**."
- Close and lock the pressure cooker lid. Adjust the pressure valve on top to Airtight and press the **SOUP & STEW** function switch.
- When the pressure cooker has finished the cooking cycle, release all the pressure by carefully setting the valve to Exhaust on the top of the lid. Once all the pressure has released, the lid can be turned and unlocked. Serve with rice if desired.

## CORNISH HENS BRAISED IN WHITE WINE

SERVES 4

### *Ingredients*

2 tablespoons olive oil	1 tablespoon minced parsley
2 Cornish hens, trussed	1 tablespoon flour
1/2 teaspoon salt	1/2 cup dry white wine
1/4 teaspoon freshly ground black pepper	1/2 cup chicken stock
1/2 teaspoon thyme	1/4 lb mushrooms, cleaned and sliced
1/2 teaspoon basil	

### *Directions*

- Follow the "**BROWNING**" instructions in this manual heat the olive oil and brown the Cornish hens on all sides. Sprinkle them with salt and pepper, thyme, basil and parsley. Remove and set aside. Cancel "**BROWNING**."
- In the cooking pot, stir in the flour, and then pour in the wine and stock and add the hens back in.

- Close and lock the lid and program the pressure cooker for 40-minutes.
- When the pressure cooker has finished the cooking cycle, release the pressure by carefully setting the valve to Exhaust on the top of the lid. Once the pressure has released, the lid can be turned and unlocked. Serve with rice or a salad if desired.

Recipes courtesy of [www.peggyunderpressure.com](http://www.peggyunderpressure.com)

## **SOUTHERN TANGY PULLED ROAST BEEF**

SERVES 4

### ***Ingredients***

3-4 Lb. Chuck Roast	2 to 4 oz butter (half a stick or 1 stick)
1 Packet of Ranch Dressing Powder	1 Jar of Peppercornis
1 Packet of Au Ju Mix Powder	

### ***Directions***

Place about 4 peppers into bottom of the cooking pot first. Then place chuck roast on top of them. This will lift roast up off bottom of pan and prevent burning and overheating.

Open packets of seasonings and sprinkle them both over top of the roast, covering as much as possible. Place a few more peppercornis on top of roast, and around it. Then pour about 1/4 to 1/2 of the peppercornis liquid into the pot. Add 1/2 cup of water, put whole piece of butter directly on top of roast.

Program the pressure cooker to cook for 60-minutes.

You can serve this roast any way you like.

## **BALSAMIC CHICKEN AND ONIONS**

SERVES 4

### ***Ingredients***

2 lbs. Chicken Thighs (You can use chicken breast to cut down on calories.)  
 1 Ham Hock  
 2 Cups Chopped Carrots (Frozen or fresh, but don't use baby carrots)  
 2 Cups Pearl Onions (Frozen or fresh)  
 1 Cup Dried Mixed Berries (You can use any kind, a mix or just golden raisins.)

2 Bay Leaves  
 4 Cloves of Garlic  
 1 Cup Balsamic Vinegar  
 1 Cup Red Wine Vinegar  
 1/2 Cup Chicken Broth (Optional: since the chicken releases a lot of liquid already.)

*Directions*

Season the chicken on both sides with salt and pepper. Then place ham hock and chicken into bottom of inner pot. Place all remaining ingredients into pot. The chicken will brown on the side touching the bottom of the pot.

Close and lock the lid on your pressure cooker. Make sure the Pressure Valve is set to Airtight.

Press **MEAT & CHICKEN** program button on your machine OR program the pressure cooker for 17-minutes.

When the pressure cooker finishes the cooking cycle, it's time to release the pressure. Carefully turn the Pressure Valve on the top to EXHAUST and wait for all steam and pressure to release. The Float Valve will drop, allowing you to unlock the lid.

You'll notice that the level of liquids inside the pot has almost doubled. Use a pair of tongs and carefully remove the chicken. Set chicken aside and go back to the remaining sauce. Ladle out or pour out half of that liquid and return it back to the pressure cooker to reduce/thicken the sauce. Follow instructions in this manual for "**BROWNING**." Reduce the sauce so it becomes nice and thick. Help it along by adding flour or cornstarch if you like.

Once the sauce is thickened to the desired consistency, cancel "**BROWNING**" and return chicken carefully back into the sauce. Set the pressure cooker to Keep Warm until ready to serve. Serve with rice or mashed potatoes.

**HAWAIIAN BBQ CHICKEN**

SERVES 4

***Ingredients***

3lbs. Chicken (Frozen or Fresh; Breast, Thighs, Wings or Drumettes)  
 1 Cup BBQ Sauce  
 2 Cups Diced Pineapples (Canned or Fresh)

1 Cup Coconut Milk  
 1 Tbsp Chili Flakes (Or more to taste)  
 Shredded Coconut (garnish)  
 Juice of Limes (garnish)

*Directions*

Mix BBQ Sauce, Coconut Milk and Chili Flakes together. In main cooking pot of your pressure cooker, place the pineapples at the very bottom. This will be closest to the heat source and will render out the pineapple juice so the pressure cooker will use the juices to steam and pressurize since the BBQ sauce mixture is quite thick and may burn if you place it on the very bottom.

Start dipping chicken pieces in the BBQ sauce mixture, a thin coat is fine. Add them into the pot one by one. Pour the remaining sauce mixture over the chicken when you're done. Shut the lid of the pressure cooker, turn to lock it. Set the pressure valve to Airtight. Program pressure cooker for 10-minutes.

Once the cooking cycle is finished, release pressure and unlock lid. The chicken and pineapples will have released liquids during the pressure cooking process so there will be lots of liquid inside. Remove just the chicken with a pair of tongs and set aside temporarily. At this time, you can use a potato masher and mash down the pineapples so they become pulpy. (If you want the sauce

extra thick, you can also make a roux with a bit of the liquid ladled out in a little bowl, mix a bit of flour with it until smooth and pour it back into the pot.)

Once the sauce has thickened to your desired consistency, place the chicken back in. Now it's ready to serve with rice or on its own. Garnish with a healthy heap of shredded coconut and a squeeze of lime juice.

## **ITALIAN POT ROAST**

SERVES 4

### ***Ingredients***

3-lbs Beef Rump Roast (Cut into 2" chunks; you can choose to leave the roast whole, but cooking time will be 60-75 minutes)

1 Jar/Can of Roasted Red Bell Pepper

1 Jar/Can of Sun Dried Tomatoes in Olive Oil

1 Jar/Can of Marinated Artichokes in Water

1 Whole Onion (Finely Sliced)

4 Whole Garlic (Minced)

1 Package of Mushrooms (Chopped)

2 Tbsp Italian Seasoning

### ***Directions***

Remove the fat from the roast and use a sharp knife to cut the meat into whole 2 inch chunks. Pre-cook the meat in the pressure cooker first to do a "wash". This removes all the unwanted fat and gristle from the meat so it leaves the end result cleaner.

Place the meat into the pressure cooker and pour in 3-4 cups of water. Season with salt and pepper if you wish. Shut the lid and lock into position. Set the valve to AIRTIGHT and program pressure cooker for 10-minutes.

When the pressure cooker is pressurized and cooks for 10-minutes, it'll automatically beep and go to Keep Warm. You can release the pressure by setting the pressure valve to EXHAUST. Remove the meat into a bowl. Discard all the grimy water. Rinse the meat in the bowl to remove any remaining residue and then place back into the cooking pot of the pressure cooker again.

Add the remaining ingredients in with the meat. Julienne the bell peppers, and chop the artichokes. Leave the sun dried tomatoes as is unless they need chopping as well. Include the olive oil and water from the jars of bell peppers, sun dried tomatoes and artichokes. Do not drain. Pour them into the pressure cooker pot.

Add the onions and mushrooms and garlic. Add the Italian Seasoning.

Lock the lid and set the pressure cooker to cook for an additional 20-minutes. When the pressure cooker beeps, allow the pressure to naturally release or help it along by setting the valve to EXHAUST. Release the pressure before opening the lid.

You can use the cooking juices from the cooking to make gravy. Use a slotted spoon and ladle out all the meat and vegetables, and put them into a

separate serving platter. In a small bowl, mix half a cup of water with 1 tbsp of flour and mix until it becomes a runny white goo. Stir it while slowly pouring in the flour mixture and keep stirring and simmering until the gravy becomes a nice thick consistency.

Serve your pot roast over mashed potatoes or some pasta or with a side of roasted potatoes. Top with the fresh gravy.

## **ST. PATRICK'S BANGERS AND MASH**

### ***Ingredients***

1 Package of 6-8 Bangers  
5-6 Baking Potatoes (Peeled and Diced)  
1 Cup Milk

1/2 Cup Butter  
Salt & Pepper  
1 Whole Onion (Sliced into rings)

### **FOR THE POTATOES:**

1/2 Cup Sour Cream  
1/2 Cup Parmesan Cheese

### **OTHER EQUIPMENT:**

Potato Masher  
Sheet of Foil

### ***Directions***

Peel and dice potatoes and place in bottom of pressure cooker pot. (You can leave the peels on, just scrub them real well if you do.) Lightly toss with salt and pepper. Add the cup of milk. Slice tabs of butter and place them over the potatoes. Carefully lay a sheet of foil over the potatoes and place sausages onto the foil and make sure they do not risk rolling off. Top the sausages with onions.

Close lid and secure into place. Adjust the pressure valve to "AIRTIGHT" and program the pressure cooker for 20-minutes. The 20-minutes will begin to count down and the internal hot pressure will continue to cook the food.

Once the allotted time has expired, the machine will beep and go to keep warm automatically. You can choose to either release all pressure manually by turning the valve to Exhaust or let it drop down naturally. When all pressure has released, the float valve will drop down and allow you to turn and open the lid.

Remove the sausages in the foil. You'll notice that the sausages are cooked but look grey.

Now onto the potatoes. Start mashing them carefully with a potato masher directly inside the pressure cooker pot - avoid scratching the non-stick of the inner pot. Add more milk, salt or butter if you prefer to get potatoes to desired consistency. To serve, you may slice the sausages instead of leaving them whole if you prefer.

**APPLES AND ONION PORK TENDERLOIN**

SERVES 4

***Ingredients***

- |                                      |  |
|--------------------------------------|--|
| 3-5 lb. Pork Rump or Pork Tenderloin | 2 Cups Apple Juice                                       |
| 3 Apples (Sliced)                    | 1 Cup Broth (Chicken, Beef or Vegetable, doesn't matter) |
| 1 Whole Onion (Sliced)               | Salt & Pepper to taste                                   |
| 2 Bay Leaves                         |  |

***Directions***

Remove any unwanted fatty pieces from pork. Season with salt and pepper on both sides.

Place onions and apples into cooking pot. Pour in apple juice and broth. Place the pork rump directly into pot. Shut the lid and turn it to lock it into place. Make sure Pressure Valve is set to Airtight. Program pressure cooker for 60-minutes. It'll take 5-10 minutes for the machine to heat up and build up the pressure. The 60-minute cook time will begin to count down.

When the pressure cooker is finished with the cooking cycle, it will beep and automatically go to keep warm. At this point, you can manually release the pressure or allow it to Natural Release. Once the float valve has dropped and the lid is safe to open, unlock and lift the lid up. Release any remaining pressure and turn to open the lid. The onions and apples should melt as soon as you stir them. The pork is super juicy and tender. Slice into thick slices and serve over mashed potatoes or stuffing and ladle on the apple and onion gravy.

**ITALIAN POTATO, RICE, & SPINACH SOUP**

SERVES 6

***Ingredients***

- |                                  |  |
|----------------------------------|--|
| 1/4 cup olive oil                | 2 tablespoons fresh lemon juice                      |
| 6 leeks, white part only, sliced | 3 tablespoons tomato paste                           |
| 3 garlic cloves, crushed         | 1 tablespoon light brown sugar                       |
| 2 carrots                        | 10 ounces fresh spinach, rinsed, cut in large pieces |
| 1/2 cup Arborio rice             | 1/4 cup parmesan cheese, grated                      |
| 3 potatoes, cut in large chunks  | 1/4 cup fontinella cheese, grated                    |
| 5 cups chicken stock             | 2 teaspoons dried basil                              |
| 1/2 cup parsley, chopped         | 1/4 teaspoon pepper                                  |
| 1/2 cup celery, chopped          |  |
| 1 bay leaf                       |  |
| 1 teaspoon salt                  |  |

***Directions***

- Follow the "**BROWNING**" instructions in this manual and heat oil. Add leeks, garlic, and carrots and sauté in hot oil for 2 minutes. Cancel "**BROWNING**."
- Add rice and potatoes. Stir well.
- Add broth, parsley, celery, bay leaf, salt, pepper, basil, lemon juice, tomato paste and brown sugar. Stir well.
- Close and lock the pressure cooker lid. Adjust the pressure valve on top to Airtight and press **SOUP & STEW**.



- Cooking should be approximately 15-20 minutes.
- When the pressure cooker has finished the cooking cycle, release all pressure by carefully setting the valve to Exhaust on the top of the lid. Once all pressure has released, the lid can be turned and unlocked.
- Lift lid. Ladle the soup into large serving bowl or individual bowls.
- Combine the cheeses and sprinkle over soup. Serve with Italian bread.

## SOUTH OF THE BORDER SPICY CHILI

SERVES 6

Chili is a nutritionally sound and complete meal. You can make it more or less fiery by adjusting the amount of chili powder used.

### **Ingredients**

2 tablespoons olive oil	1 bay leaf
2 medium onions, chopped	2 teaspoons celery seed
3 garlic cloves, minced	Salt to taste
1 1/2 lb ground beef	1 tablespoon flour
2 teaspoons ground cumin	1 1/2 cups crushed tomato
2 tablespoons chili powder, or to taste	1 cup beef stock
1 1/2 teaspoons oregano	1 1/2 cups cooked pinto or red kidney beans

### **Garnishes**

Grated cheddar or Monterey Jack cheese  
 Finely chopped onion  
 Shredded lettuce

### *Directions:*

- Follow the "**BROWNING**" instructions in this manual: heat oil and sauté the onion and garlic until onion is wilted.
- Add beef and cook until browned. Mix cumin, chili powder, oregano, bay leaf, celery seed, salt and flour. Stir in crushed tomato and beef stock. Cancel "**BROWNING.**"
- Add the beans.
- Close and lock the pressure cooker lid. Adjust the pressure valve on top to Airtight and press the **BEANS & GRAINS** function switch.
- When the pressure cooker has finished the cooking cycle, release all pressure by carefully setting the valve to Exhaust on the top of the lid. Once all pressure has released, the lid can be turned and unlocked.
- Serve chili in bowls, passing the garnishes separately.

## SAUSAGE AND LENTIL SOUP

SERVES 4

### *Ingredients*

3-4 Cups Dried Lentils	2 Bay Leaves
1-2 Cups Chopped Sausage (any sausage to your liking)	2 Tbsp Beef Bullion (Or 2 Cups Beef Broth)
2 Cups Crushed Roasted Tomatoes	6 Cups Fresh Water (Less or more depending on the size of your pressure cooker.)
1 Cup Mirepoix (chopped mixture of celery, carrots and onions.)	Salt & Pepper to taste
4 Garlic cloves, minced	

### *Directions*

- Follow the "**BROWNING**" instructions in this manual: sauté the mirepoix and garlic until they are fragrant. Cancel "**BROWNING**."
- Add remaining ingredients into the cooking pot. Shut lid and lock properly into position. Adjust the Pressure Valve to "Airtight". Program pressure cooker for 15-minutes.
- When the cook time is complete and it's ready to release the pressure, make sure you are careful. Since it's a big pot of soup, there may be some spitting at the pressure valve when you turn it to exhaust. Sometimes a folded up dish rag or towel over the valve will help.
- When it is safe to open the lid, give the soup a good stir. It may appear a bit watery but depending on if you want to keep it more on the brothy side or you want to thicken it a bit, you can thicken it by mixing a bit of the broth liquid with flour until it becomes a thick roux and pour the roux back into the soup and stir it. Season with salt and pepper to your preference. Serve with a dollop of sour cream or plain greek yogurt.

## KIELBASA, BUTTERNUT SQUASH & KALE SOUP

SERVES 4

### *Ingredients*

1 Package Kielbasa Sausage (Chopped into half-moon size)	2 Cups Fresh Kale
4 Cups Chicken Broth	4 Cloves Garlic, Minced
2 Cups Chopped Butternut Squash	Water
2 Sprigs of Fresh Rosemary	1 Shot Glass Sherry, Cooking Wine or White Wine
1 Onion, Chopped	1 Cup Wild Rice (I ran out, so I just used brown rice)

### *Directions*

Follow the "**BROWNING**" instructions in this manual: add a bit of olive oil and place the first 4 ingredients in and sauté for 4 minutes. Pour in shot glass of cooking wine or sherry and sauté for another 2-3 minutes. Cancel "**BROWNING**."

Add the wild rice and chicken broth. Depending on how much soup you want, you can fill up the rest of the pot with water and add in the sprigs of fresh Rosemary. **Do not add the Kale into the soup yet.**

Close and lock pressure cooker lid. Set Pressure Valve to "Airtight" and program the pressure cooker for 10-minutes.

**Note:** If you are making a really large, almost full pot, the pressure cooker will take quite a while to heat up everything inside and come to pressure, about 20 to 30-minutes to build up pressure. Once the pressure has been reached the 10-minutes will begin to count down. Once the 10-minutes have reached 0, the cooker will automatically beep and go to keep warm.

Using a dish rag, carefully release the pressure by turning the Pressure Valve to “Exhaust”. Once the pressure has been completely released, the float valve will drop which will release the locking mechanism on the lid. Now you can turn the lid to unlock it. Give everything a good stir. When the soup is ready to serve, you can add the kale and let the heat of the soup cook it just slightly. It will take less than a minute. Add salt and pepper to taste as you serve.

**(This step is optional).** Use an Immersible Hand Blender and in the soup mixture. Give it a few pulses to blend the soup into a smooth creamy texture. Now add the chopped carrots, potatoes and ham to the soup. Add salt and pepper.

Place Ham Hock back in and shut the lid. (Don’t let the soup sit idle for too long because it will thicken as it sits and keeps warm. If it becomes too thick, add water or chicken stock.)

Program pressure cooker to cook for another 5-minutes.

If the soup mixture is too thick, the machine might have a hard time building up pressure because the thick mixture might be over-heating at the bottom of the pot. If this happens, the machine will just beep fairly soon and put itself on Keep Warm. Leave the machine alone. It will have built up enough pressure in that time so just let it sit and drop down in pressure automatically. The carrots and potatoes are cut up small enough that it should cook fairly quickly. If not, you can always open up the lid, thin the soup down a bit and restart it. When the soup is finished, serve while it’s hot with some butter toast or croutons.

## **FISHERMAN’S SEAFOOD CHOWDER**

SERVES 4

### ***The Soup Base Ingredients***

A Mild Roux Mix  
1 Tbsp Flour

1 Tbsp Butter  
1 Cup White Wine

### ***The Stock & Other Ingredients***

2 Cups Water  
1 Cup Chicken Stock  
1 Whole Onion (Chopped)  
2 Whole Tomatoes (Chopped)  
1/2 Cup Corn (Optional)

1/2 Cup Celery (Optional)  
4 Cloves of Garlic (Chopped)  
1 Can Tomato Sauce  
3 Bay Leaves  
1/2 Tsp Saffron Strands

### ***Directions***

To make a roux, follow the “**BROWNING**” instructions in this manual: melt the butter and then add the flour to the butter and mix with a wooden spoon. Start diluting the roux with the white wine little by little.

To the roux mix, add the chopped onions, garlic and chopped tomatoes, plus the celery. Cook the mixture for just a couple of minutes and cancel "**BROWNING**." The mixture should be thick and creamy. Season with salt and pepper.

Add the water, tomato sauce and chicken stock. Add bay leaves and saffron. Give everything a good mix. The soup base should be pretty watery with a slight hint of thickness. If it's still too thick, add more water or stock or white wine.

**SEAFOOD INGREDIENTS**

- |  |   |
|--|---|
| 1-2 Cups Seafood Mix (Calamari Rings, Scallops, Bay Shrimps, etc.) | 1-2 Cups Whole Mussels                              |
| 1-2 Cups Whole Clams   | 1-2 Cups Langostino Tails                           |
| 1-2 Cups Whole Shrimp (Shells removed)                             | 1-2 Cups Chopped Salmon (Or any other fish is fine) |

Add the seafood to the soup base mix. You always want to leave at least about 2-inches from the top rim to prevent over-flowing. (If you like, you can remove the shells so there is more room.)

Once the seafood has been added, give everything another good stir. Then shut lid and turn to lock it into position. Adjust Pressure Valve to "Airtight".

Program the pressure cooker for 10-minutes.

When the pressure cooker is finished with its cooking cycle, it will beep and go to keep warm automatically and start dropping the pressure down by itself. This recipe, you can choose to release the pressure manually or let it drop down in pressure by itself, it doesn't make a difference. But always check that "Pressure Float Valve" has dropped before attempting to turn the lid to unlock and open it.

Serve with slices of sourdough bread or crackers.

**LEEK & ASPARAGUS RISOTTO**

SERVES 4 -6

***Ingredients***

- |                             |  |
|-----------------------------|--|
| 1 1/2 tablespoons olive oil | 1 1/2 cups Arborio rice                        |
| 1 1/2 tablespoons butter    | 4 cups vegetable broth                         |
| 1 1/2 tablespoons water     | 1/4 lb asparagus, chopped into 1 inch segments |
| 2 garlic cloves, minced     | 1 1/4 cups parmesan cheese, shredded           |
| 1 1/2 cups leeks, sliced    |  |

***Directions***

- Follow the "**BROWNING**" instructions in this manual: heat the olive oil and butter.
- Add the garlic and leeks, sauté until soft then cancel "**BROWNING**."
- Add rice, stir thoroughly and then add broth.
- Close and lock pressure cooker lid. Adjust pressure valve to Airtight and press RICE.
- While risotto cooks, steam asparagus in water. Then sauté in olive oil. Season with salt and pepper.

- When the pressure cooker has finished the cooking cycle, release all pressure by carefully setting the valve to Exhaust on the top of the lid. Once all pressure has released, the lid can be turned and unlocked. Add the sautéed asparagus, and Parmesan cheese.
- Serve immediately.

## CHICKEN NOODLE

SERVES 6

### *Ingredients*

8 boneless skinless chicken thighs	2 sprigs fresh sage
3 carrots, large dice	1 teaspoon poultry seasoning
1 onion, chopped	salt and pepper, to taste
3 stalks celery, finely diced	1 lb egg noodles, frozen such as Reames brand
2 garlic cloves, chopped	1 cup frozen peas
8 cups chicken stock	3 tablespoons stock
1 bay leaf	1 lemon, juice of
5 sprigs fresh thyme	1/4 cup parsley, chopped
1 sprig fresh rosemary	

### *Directions*

- Follow the "**BROWNING**" instructions in this manual: saute onion, celery and garlic until lightly browned. Cancel "**BROWNING**." Add chicken, carrot, chicken stock, bay leaf, herbs & seasonings.
- Close and lock pressure cooker lid. Adjust pressure valve to Airtight.
- Program to cook for 10 minutes. Allow pressure to naturally release.
- Open pressure cooker lid when safe to do so.
- Add frozen egg noodles, close and lock pressure cooker lid. Adjust pressure valve to Airtight and program to cook 3 minutes.
- When the pressure cooker has finished the cooking cycle, release all pressure by carefully setting the valve to Exhaust on the top of the lid. Once all pressure has released, the lid can be turned and unlocked.
- Remove sprigs of fresh herbs. Add peas & chopped parsley for color and juice of 1 lemon. Stir and serve.

## CREAM OF GARDEN TOMATO SOUP

SERVES 4-6

### *Ingredients*

1 tablespoon vegetable oil	teaspoon dried)
1 tablespoon butter	1 teaspoon salt
1 large yellow onion, finely chopped (you can also use a white onion)	1/4 teaspoon black pepper, freshly ground
3 lbs tomatoes, coarsely chopped	1/2 cup chicken broth (or vegetable broth or water)
2 teaspoons fresh thyme, chopped (or 1	3/4 cup heavy cream

### *Directions*

- Follow the "**BROWNING**" instructions in this manual: heat oil and butter in the pressure cooker until butter melts. Add the onion and cook, stirring occasionally, until wilted, about 5 minutes. Cancel "**BROWNING**."
- Add tomatoes and their juices, thyme, salt, pepper, and broth and stir to mix.
- Lock on the lid and set Valve to Airtight. Press **SOUP & STEW** button.
- When the pressure cooker has finished the cooking cycle, release all pressure by carefully setting the valve to Exhaust on the top of the lid.
- Once all pressure has released, the lid can be turned and unlocked.
- Use immersion blender to puree soup (or transfer soup to blender or food processor and puree in smaller batches to avoid burning yourself).
- If after blending you see any chunks of tomato peel, put soup through strainer or food mill to remove.
- If using right away, place soup in large pan and stir in cream. Reheat gently without boiling then add garnish of choice and serve.
- If not using right away, store in the refrigerator until ready to use; then stir in the cream, heat and serve.

## BROWN RICE

SERVES 4-6

### *Ingredients*

4 cups water	3 dashes Mrs. Dash seasoning mix, original
2 cups long brown rice	3 tablespoons butter
4 chicken bouillon cubes	pepper

### *Directions*

- Add all ingredients to Inner Pot.
- Lock on the lid and set Valve to Airtight. Press **RICE** button.
- When the pressure cooker has finished the cooking cycle, release all pressure by carefully setting the valve to Exhaust on the top of the lid.
- Once all pressure has released, the lid can be turned and unlocked.
- Remove and serve.

**BABY BACK RIBS – FAST & EASY**

SERVES 2-3

***Ingredients***

- |                            |                          |
|----------------------------|--------------------------|
| 3 lbs beef back ribs       | 1/4 teaspoon paprika     |
| 1/2 teaspoon salt          | 2 tablespoons olive oil  |
| 1/4 teaspoon black pepper  | 1 cup beer               |
| 1/2 teaspoon onion powder  | 12 ounces barbecue sauce |
| 1/4 teaspoon garlic powder |                          |

***Directions***

- Cut ribs into serving pieces.
- Mix spices together to create a dry rub. Apply the dry rub to the ribs.
- Follow the "**BROWNING**" instructions in this manual: heat oil and brown the ribs on all sides. Cancel "**BROWNING**."
- Add beer. Close and lock lid securely, set the Valve to Airtight.
- Press **MEAT & CHICKEN** button.
- When the pressure cooker has finished the cooking cycle, release all pressure by carefully setting the valve to Exhaust on the top of the lid.
- Once all pressure has released, the lid can be turned and unlocked.
- Add barbecue sauce and serve immediately.

**POT ROAST WITH MUSHROOM GRAVY**

SERVES 6-8

***Ingredients***

- |                                     |   |
|-------------------------------------|---|
| 3 lbs chuck roast, 2-3 inches thick | 2 (10 3/4 oz) cans cream of mushroom soup |
| 2 tablespoons vegetable oil         | 1 cup water (or beef or chicken stock)    |
| 1 envelope onion soup mix           |   |

***Directions***

- Follow the "**BROWNING**" instructions in this manual: brown meat on all sides in oil.
- Mix all other ingredients and add to pot, coating meat. Cancel "**BROWNING**."
- Close and lock lid securely, set the Valve to Airtight.
- Program the pressure cooker to cook 50-60 minutes.
- When the pressure cooker has finished the cooking cycle, release all pressure by carefully setting the valve to Exhaust on the top of the lid.
- Once all pressure has released, the lid can be turned and unlocked.
- Thin gravy with beef stock or thicken to your own taste.

**CHICKEN STOCK**

SERVES 6

***Ingredients***

- |   |  |
|---|--|
| 2 lb chicken parts, primarily backs,<br>but also including gizzards, necks, hearts<br>and wings | 2 sprigs parsley                                     |
| 1 medium onion, peeled and halved   | 6 peppercorns or 1/4 teaspoon ground<br>black pepper |
| 1 celery stalk, cut in several pieces   | 1 teaspoon thyme                                     |
| 1 large carrot, scraped and cut in several<br>pieces  | 2 bay leaves   |
|   | Salt to taste  |
|   | 6 cups water   |

***Directions:***

- Combine all ingredients in the pressure cooker's inner pot.
- Close and lock lid securely, set the Valve to Airtight.
- Program Pressure Cook Time for 45 minutes.
- When the pressure cooker has finished the cooking cycle, release all pressure by carefully setting the valve to Exhaust on the top of the lid.
- Once all pressure has released, the lid can be turned and unlocked.
- Strain by pouring it through a strainer which has been lined with a couple of layers of damp cheesecloth, damp kitchen towel or damp paper towels. Press with the back of a wooden spoon to extract as much liquid as possible. Cool, then refrigerate overnight and remove any congealed fat that has collected on the surface.

**OLD FASHIONED MEAT LOAF**

SERVES 4

***Ingredients***

- |   |                                  |
|---|----------------------------------|
| 1 1/2 lb mixture of chopped or ground lean<br>beef, pork and veal | 1 garlic clove                   |
| 1 teaspoon salt   | 1 egg                            |
| Freshly ground pepper   | 2 tablespoons chicken stock      |
| 2 slices bread, soaked in water and<br>squeezed dry               | 2 teaspoons Worcestershire sauce |
| 2 tablespoons parsley   | 2 tablespoons olive oil          |
| 1 medium onion, minced  | 1 cup tomato sauce               |
|   | 1 cup water                      |

***Directions***

- In a bowl, combine the chopped meat, salt, pepper, bread, parsley, onion, garlic, egg, chicken stock and Worcestershire sauce.
- Shape into two small loaves. Wrap each in wax paper and chill several hours to firm.
- Follow the "**BROWNING**" instructions in this manual: heat oil and brown the loaves well on all sides. Cancel "**BROWNING**."
- Transfer to the cooker basket.
- Pour off the oil and combine the tomato sauce and water, and season with salt and pepper.
- Spread the ketchup over the meat loaves and lower the basket into the pot.
- Close and lock lid securely, set the Valve to Airtight.
- Set Pressure Cook Time to 25 minutes.



- When the pressure cooker has finished the cooking cycle, release all pressure by carefully setting the valve to Exhaust on the top of the lid.
- Once all pressure has released, the lid can be turned and unlocked.
- Slice and serve immediately.

## TOMATO PASTA SAUCE

SERVES 2-3

### *Ingredients*

3 tablespoons canola oil	3 teaspoons dried basil
1/2 cup onion, finely chopped	2 teaspoons dried oregano
3/4 cup carrot, finely chopped	1 teaspoon dried parsley
3/4 cup celery, finely chopped	1 or 2 bay leaves
2 garlic cloves, minced	1/4 cup dry red or white wine
1 large can crushed canned tomatoes	1/2 cup water
1/4 cup tomato paste	Salt and freshly ground pepper, to taste

### *Directions*

- Follow the "**BROWNING**" instructions in this manual: heat the oil and sauté the onion, carrot, celery and garlic until they are softened. Cancel "**BROWNING**."
- Add all the remaining ingredients. Close and lock lid securely, set the Valve to Airtight. Program to pressure cook for 10 minutes.
- When the pressure cooker has finished the cooking cycle, release all pressure by carefully setting the valve to Exhaust on the top of the lid.
- Once all pressure has released, the lid can be turned and unlocked.
- Reduce the sauce if it is not thick enough.

## POTATO AND GREEN BEAN CASSEROLE

SERVES 4-6

### *Ingredients*

3 potatoes, peeled and cut in 1" cubes	1 green pepper, diced
3/4 lb green beans	1 tablespoon minced parsley
1 tablespoon olive oil	Salt and freshly ground pepper
1 medium onion, minced	1/2 cup chicken stock
1 garlic clove, minced	

### *Directions*

- Add all ingredients to the inner pot. Close and lock lid securely, set the Valve to Airtight.
- Program Pressure Cook Time to 7 minutes.
- When the pressure cooker has finished the cooking cycle, release all pressure by carefully setting the valve to Exhaust on the top of the lid.
- Once all pressure has released, the lid can be turned and unlocked.
- Serve and Enjoy.

## LEMON CHICKEN

SERVES 4

### *Ingredients*

3 1/2 lb chicken cut into serving pieces	2 teaspoons oregano
1/4 cup plus 2 tablespoons olive oil	Salt and freshly ground pepper to taste
1/4 cup lemon juice	1/2 cup chicken stock

### *Directions:*

- In a small bowl, mix together 1/4 cup oil, lemon juice, oregano, salt and pepper. Pour over the chicken and marinate for several hours, or overnight.
- Dry the chicken well on paper towels and sprinkle with salt and pepper. Reserve the marinade.
- Follow the "**BROWNING**" instructions in this manual: heat the remaining 2 tablespoons oil and brown the chicken pieces on all sides. Cancel "**BROWNING**."
- Reserve chicken pieces on warm platter. Pour off the fat and add to the inner pot the reserved marinade and the chicken stock.
- Close and lock lid securely, set the Valve to Airtight.
- Press **MEAT & CHICKEN** button.
- When the pressure cooker has finished the cooking cycle, release all pressure by carefully setting the valve to Exhaust on the top of the lid.
- Once all pressure has released, the lid can be turned and unlocked.
- Serve the chicken with the sauce spooned over it.

## OLD FASHIONED BAKED BEANS

SERVES 4

### *Ingredients*

2 cups dry navy beans (also called white beans or pea beans)	2 fl oz (1/2 small can) tomato paste
3 tablespoons oil	3 tablespoons brown sugar
1 large onion, diced	2 tablespoons molasses
1 clove garlic, minced	1/2 teaspoon prepared mustard
1 3/4 cups water	1/4 teaspoon cumin
	1/8 teaspoon chili powder

### *Directions*

Rinse and then soak the beans in water for about 8 hours. You can begin soaking them in the morning so they will be ready to cook at supertime. Drain the soaking water after the beans are hydrated. Add all ingredients except the beans to the inner pot and stir. Then add the beans. Close and lock lid securely, set the Valve to Airtight. Press the **BEANS & GRAINS** button. When the pressure cooker has finished the cooking cycle, allow all pressure to naturally release. Once all pressure has released, the lid can be turned and unlocked. Serve with whole wheat bread.

**MACARONI PUTTANESCA**

SERVES 4-5

***Ingredients***

- 1 26oz jar of puttanesca, marinara or your favorite sauce
- 1 16oz box of macaroni (or any type of pasta)
- 1 bag of frozen meatballs
- 1 onion, diced
- 1 bell pepper, diced (any color)
- 2 cloves garlic, minced
- salt & pepper
- Olive oil for browning
- (recipe may be doubled for larger portions)

***Directions:***

- Remove lid. Start browning function. Add oil to inner pot. Add onion, bell pepper and garlic to inner pot.
- Stir while browning. Season with salt & pepper.
- Keep browning until onions are caramelized.
- Add jar of sauce, box of macaroni, and frozen meatballs to inner pot.
- Add 1-1.5 cups of water to inner pot. Place lid onto pressure cooker and lock into place.
- Set pressure limiting valve to "Airtight."
- Press **RICE** button.
- When the pressure cooker has finished the cooking cycle, release the pressure by carefully setting the valve to Exhaust on the top of the lid. Once the pressure has released, the lid can be turned and unlocked. Remove and serve.

DESSERTS

**APPLESAUCE**

Makes about 4 1/2 cups

***Ingredients***

- |   |                             |
|---|-----------------------------|
| 3 lb apples, peeled, cored, and quartered | Optional: Grated lemon zest |
| 3/4 teaspoon ground cinnamon              | Optional: Fresh lemon juice |
| 1/3 cup water or apple juice              | Optional: Honey             |

***Directions***

- Place the apples, cinnamon, and water (or juice) into pot.
- Close and lock lid securely, set the Valve to Airtight.
- Press **DESSERTS** button.
- When the pressure cooker has finished the cooking cycle, release all pressure by carefully setting the valve to Exhaust on the top of the lid.
- Once all pressure has released, the lid can be turned and unlocked.
- You can serve the applesauce chunky, or puree it in a food processor.
- Prior to serving, if desired, stir in the lemon zest, lemon juice, and honey to taste.
- Serving Suggestion: Top warm applesauce topped with some raisins and chopped, toasted walnuts.

## CREAMY CHEESECAKE WITH FRUIT GLAZE

Makes one 7-inch cheesecake

### *Ingredients*

1 tablespoon butter	2 teaspoons grated lemon zest
4 tablespoons bread crumbs or cookie crumbs	2 tablespoons flour
Two 8-oz packages of cream cheese	6 tablespoons sour cream
3/4 cup sugar	2 eggs
1/4 cup heavy cream	2 egg yolks
2 teaspoons vanilla	2 cups water

### *Directions*

- Butter a 7 inch spring-form mold or other suitable baking dish safe (not included) to use in this pressure cooker.
- Sprinkle with bread or cookie crumbs and set aside.
- Blend the cream cheese, sugar, cream, vanilla, lemon zest, flour, and sour cream. Beat in the eggs and egg yolks, and pour the entire mixture into the mold.
- Center the uncovered pan on a 24" long piece of aluminum foil. Cover the top of the pan with another piece of foil and pinch around the edges to seal. Scrunch up the ends of the length of foil and bring them together over the pan to create a handle.
- Set the rack in the pressure cooker and pour in the water.
- Lower the foil-covered mold into the pressure cooker and place on the rack.
- Close and lock lid securely, set the Valve to Airtight
- Press the **DESSERTS** button.
- When the pressure cooker has finished the cooking cycle, allow all pressure to naturally release.
- Once all pressure has released, the lid can be turned and unlocked.
- Remove the pan from the pressure cooker using the foil handle. Loosen the foil, cool, then chill for at least 4 hours or overnight.
- Before serving, arrange fruit or spread fruit preserves in a thick layer over the cheesecake.
- Release and remove the rim of the spring-form pan.

## ORANGE-FLAVORED CANDIED YAMS

SERVES 4

### *Ingredients*

1 cup orange juice	1/2 cup brown sugar
2 large sweet potatoes (yams)	1 teaspoon grated orange zest
Salt, to taste	2 tablespoons butter

### *Directions*

- Pour orange juice into pressure cooker. Peel sweet potatoes and cut them in half lengthwise. Arrange in a pressure cooker steamer basket (not included) and sprinkle with salt, brown sugar and orange zest. Dot with butter.
- Lower steamer basket into pressure cooker.

- Close and lock the pressure cooker lid. Adjust the pressure valve to Airtight and press **DESSERTS**.
- When pressure cooker has finished the cooking cycle, release all pressure by carefully setting the valve to Exhaust on the top of the lid. Once all pressure has released, the lid can be turned and unlocked. Lift out the sweet potatoes.
- Boil down the sauce until thickened and pour over the sweet potatoes.

## SPICED APPLE CRUNCH

SERVES 3

### **Ingredients**

1 cup dry bread crumbs (unseasoned)	1 lemon (juice and rind)	3 apples, sliced
1/4 cup sugar	1/4 cup butter, melted	
1/2 teaspoon cinnamon	2 cups water	

### *Directions:*

- Butter a 15 cm (6") baking dish (not included). Combine bread crumbs (or graham wafer crumbs), sugar, cinnamon, juice and lemon rind. Place alternate layers of apples and crumbs in baking dish. Pour melted butter over ingredients and cover baking dish firmly with aluminum foil.
- Place water, rack, and then baking dish in pressure cooker.
- Close and lock lid and program the pressure cooker for 20-minutes.
- When pressure cooker has finished the cooking cycle, release all pressure by carefully setting the valve to Exhaust on the top of the lid. Once all pressure has released, the lid can be turned and unlocked
- If you wish to add more color and crunch, run the dish quickly under the broiler. Be sure to watch carefully to prevent burning.

## OLD FASHIONED RICE PUDDING

SERVES 4

It's recommended to eat on the same day or the rice may become chewy.

### **Ingredients**

1 tablespoon butter	1 egg
1/4 cup long grain rice	1/4 cup evaporated milk
2 cups milk	1/2 teaspoon vanilla
1 cup water	Cinnamon
1/3 sugar	1/2 teaspoon salt

### *Directions:*

- Follow **BROWNING** instructions in this manual: Melt butter and stir in rice, coating it with the butter. Pour in fresh milk and water, and stir in sugar and salt. Cancel **BROWNING**.
- Close and lock lid and program the pressure cooker for 10-minutes.
- When the pressure cooker has finished the cooking cycle, release all pressure by carefully setting the valve to Exhaust on the top of the lid. Once all pressure has released, the lid can be turned and unlocked.

- In a small bowl mix together the egg, evaporated milk and vanilla. Stir in a little of the hot liquid from pressure cooker, then add mixture to the pressure cooker.
- Cover again and set to cook for 5 more minutes.
- When the pressure cooker has finished the cooking cycle, release all pressure by carefully setting the valve to Exhaust on the top of the lid. Once all pressure has released, the lid can be turned and unlocked. Cool 10 minutes, stirring occasionally.
- Transfer to individual dessert bowls, continue cooling, then refrigerate. Serve sprinkled with cinnamon.

## PEARS STEWED IN RED WINE

SERVES 4

### *Ingredients*

2 cups water	4 firm pears, peeled but not cored, stems on
1/2 cup sugar	3/4 cup red wine
2 slices lemon	1 cup frozen raspberries
2 cinnamon sticks	4 tablespoons heavy cream
1/4 teaspoon mace	

### *Directions:*

- Follow the **BROWNING** instructions in this manual: combine the water, sugar, lemon, cinnamon sticks and mace. Simmer until sugar is dissolved.
- Cancel **BROWNING**.
- Place pears into pressure cooker cooking pot, trimming bottoms if necessary so they stand upright. Add liquid from the saucepan.
- Close and lock lid and program the pressure cooker for 10-minutes.
- When the pressure cooker has finished the cooking cycle, release all pressure by carefully setting the valve to Exhaust. Once all pressure has released, the lid can be turned and unlocked.
- Add the red wine.
- Lock lid in place again and program to cook for 10 more minutes. When the pressure cooker has finished the cooking cycle, release all pressure by carefully setting the valve to Exhaust. Once all pressure has released, the lid can be turned and unlocked.
- Carefully remove only the pears and transfer to a deep container.
- Boil down the remaining sauce until it is syrup. Cool, then pour over the pears and keep at room temperature overnight.
- To serve, defrost and purée the raspberries in a processor until smooth.
- Spoon 4 tablespoons of the purée on four dessert dishes or shallow bowls. Place a pear upright in the center of each dish. Spoon some syrup over the pears.
- Dribble 1 tablespoon of cream in a circle over the sauce. With the aid of a knife, swirl the cream into the sauce in an attractive design and serve.

**CINNAMON APPLE FLAN WITH MAPLE SYRUP**

SERVES 6

***Ingredients***

5 tablespoons maple syrup	1/4 teaspoon vanilla
1/4 teaspoon cinnamon	6 tablespoons sugar
2 apples, peeled and cut in 1/4" slices	2 1/2 cups milk
3 whole eggs 3 egg yolks	

***Directions:***

- Follow the **BROWNING** instructions in this manual: combine the maple syrup and the cinnamon. Add the apple slices and slowly simmer until the apples are tender.
- Divide the mixture into 6 greased oven-safe custard cups (not included). In a large bowl, whisk eggs and egg yolks. Stir in vanilla, sugar and milk. Pour mixture slowly into the custard cups. Cover tightly with foil.
- Fill the pressure cooker cooking pot with 2 1/2 cups water. Place as many custard cups as will fit in the pressure cooker steamer basket (if available) and lower into pressure cooker.
- Close and lock lid and program the pressure cooker for 10-minutes.
- When the pressure cooker has finished the cooking cycle, release all pressure by carefully setting the valve to Exhaust on the top of the lid. Once all pressure has released, the lid can be turned and unlocked.
- Remove the lid, take out the basket, loosen the foil and cool the custard.
- Refrigerate. To serve, loosen the custard from the molds with a knife and invert onto dessert dishes.

**COCONUT RICE PUDDING**

SERVES 4

**INGREDIENTS:**

1 Cup Arborio Rice	1/2 Tsp Freshly Ground Cloves
3 Cups Coconut Milk (Unsweetened)	1 Whole Vanilla Bean
2 Cups Almond Milk (Unsweetened)	3 Strips Orange Zest Strip
1 Cup Water	2 Cans Sweetened Condensed Milk
3 Cinnamon Sticks	

***Directions:***

- Follow the **BROWNING** instructions in this manual: add all liquid ingredients (except the condensed milk). Add spices to the mixture. Leave cinnamon sticks and orange zest strips whole. Using a knife, gently slice a long slit down the middle of the vanilla pod. Scrape the vanilla bean into the pot and swish it around. Add the whole vanilla pod also and bring the whole mixture to a light simmer. Cancel **BROWNING**.
- Add rice and give it a quick stir. Close lid and turn to lock into place. Adjust the Pressure Valve to Airtight. Program the pressure cooker for 15-minutes.
- Once the cooking is complete, let it drop down in pressure on its own, do not manually release the valve to Exhaust. The pressure should drop on its own in about 10-minutes. Once all pressure is released, the Float Valve will drop, allowing you to unlock and open the lid. Press the CANCEL button to turn off the Keep Warm feature. Remove cinnamon sticks, orange zest and vanilla pod and discard.

- Open two cans of Sweetened Condensed Milk and add to the rice pudding and stir. Allow to cool slightly, then cover and place into refrigerator to cool completely.
- Serve warm or cold with a drizzle of honey if desired. Garnish with sliced strawberries, blueberries, orange zest or nutmeg.

## **PUMPKIN BOURBON CHEESECAKE**

**SERVES 6**

### ***Ingredients***

#### **Crust:**

4-6 Macaroons  
4 Sheets Graham Crackers

1-2 Tbsp Butter

#### **Filling:**

2 (8oz.) Cream Cheese  
1/2 Cup White Sugar  
1 Tsp Vanilla Bourbon Extract  
1 Tsp Whiskey or Bourbon

3/4 Cup Canned Pumpkin  
2 Eggs  
1/2 Tsp Cinnamon  
1/4 Tsp Nutmeg  
1/4 Tsp All Spice or Pumpkin Spice

### ***Directions:***

- Using a food processor, process the Crust ingredients into a coarse and crumbly mixture. Grease spring-form pan (not included) so cheesecake doesn't stick. Take the crumbs and start forming and flattening them into pan. Make sure to have the crust come up the sides of the pan as well, about an inch high.
- For the filling, using a mixer or stand mixer, mix together the first three ingredients: cream cheese, sugar, vanilla extract and bourbon. Mix until smooth and then add remaining ingredients until that is smooth as well. Use a spatula and pour the mixture into the spring-form pan over the crust.
- Use a spoon to smooth it out as best as you can. Tap the pan a bit to get rid of any air bubbles.
- Pour 2 cups of water into the main cooking pot of the pressure cooker. Set a rack into the center of the pan and place the spring-form pan onto rack. You do NOT want the water touching the pan, that's what the rack is doing, lifting it up above the water line.
- Shut the lid and turn to lock into position. Adjust Pressure Valve to "Airtight". Program the pressure cooker for 15-minutes. The cook time will go by pretty fast, when it beeps and goes to keep warm automatically, allow the unit to drop down in pressure by itself.
- During this time, you can whip up some garnishes. You can use Whipped Cream, chopped up nuts or pumpkin butter. Put a few tablespoons of it into a little bowl and microwave it for about 20 seconds. Add a dash of whiskey to it if you want it runnier. Give it a good whisk.
- Once the pressure cooker has completely dropped down in pressure, you can open the lid and remove the cheesecake carefully. It may look too moist, but let it rest for a few minutes and then pop it into the refrigerator for at least 3-4 hours to firm up.
- Slice and garnish with pumpkin butter, whipped cream and chopped nuts and serve immediately.



Recipes courtesy of [www.allrecipes.com](http://www.allrecipes.com)

## DILL PICKLES

### *Ingredients*

8lbs 3 to 4 in long pickling cucumbers	16 garlic cloves, peeled and halved
4 cups white vinegar	8 sprigs fresh dill weed
12 cups water	8 heads fresh dill weed
2/3 cup of pickling salt	

### *Directions*

- Wash cucumbers, and place in the sink with cold water and lots of ice cubes. Soak in ice water for at least 2 hours but no more than 8 hours. Refresh ice as required. Sterilize 8 (1 quart) canning jars and lids in boiling water for at least 10 minutes.
- In a large pot over medium-high heat, combine the vinegar, water, and pickling salt. Bring the brine to a rapid boil.
- In each jar, place 2 half-cloves of garlic, one head of dill, then enough cucumbers to fill the jar (about 1 pound). Then add 2 more garlic halves, and 1 sprig of dill. Fill jars with hot brine. Seal jars, making sure you have cleaned the jar's rims of any residue.
- Follow the instructions for "How to use the Pressure Cooker for CANNING" in this manual and process sealed jars in a boiling water bath. Process quart jars for 15 minutes.
- When the unit has reached optimum pressure, it will begin to pressure-seal the mason jars. The programmed time will begin to count down until it reaches zero.
- When time has expired, the pressure cooker will beep and automatically go to Keep Warm.
- The Keep Warm indicator light will illuminate. This indicates the Pressure Cooker is Naturally Releasing the pressure. (See Notes & Tips #5)
- Open lid once pressure has completely released.
- Carefully remove jars using special canning utensils or tools. **CAUTION: Jars are hot!**
- Set jars on a towel or cooling rack and allow to cool completely in a draft-free location.
- Store pickles for a minimum of 8 weeks before eating. Refrigerate after opening. Pickles will keep for up to 2 years if stored in a cool dry place.

## JALAPENO PEPPER JELLY

### *Ingredients*

3 Green Bell Peppers, minced	½ tsp cayenne pepper
2 4oz cans diced jalapeno peppers	1 6fl oz of liquid pectin
1 ½ cups distilled white vinegar	4 or 5 drops green food coloring
6 ½ cups sugar	

### *Directions*

- In a large, stainless steel saucepan, combine peppers, vinegar, sugar, and cayenne pepper. Cook over medium high heat. Stir frequently until mixture begins to boil.
- Stir in pectin; boil 5 minutes longer, stirring constantly, and mix in food coloring. Skim off foam, and remove from heat.
- Sterilize canning jars and lids in boiling water for at least 10 minutes.

## CANNING RECIPES

- Ladle into sterilized jars and follow the instructions for “How to use the Pressure Cooker for CANNING” in this manual and process sealed jars for 5 minutes in a boiling water bath.
- When the unit has reached optimum pressure, it will begin to pressure-seal the mason jars. The programmed time will begin to count down until it reaches zero.
- When time has expired, the pressure cooker will beep and automatically go to Keep Warm.
- The Keep Warm indicator light will illuminate. This indicates the Pressure Cooker is Naturally Releasing the pressure. (See Notes & Tips #5)
- Open lid once pressure has completely released.
- Carefully remove jars using special canning utensils or tools. **CAUTION: Jars are hot!**
- Set jars on a towel or cooling rack and allow to cool completely in a draft-free location.

### FIG PRESERVES

#### *Ingredients*

16 cups of fresh figs	8 cups sugar
1 Tbsp baking soda	4 cups water
12 cups boiling water	1 lemon, sliced

#### *Directions:*

- In a large mixing bowl place figs and sprinkle with baking soda. Pour the boiling water over the figs and soak for 1 hour.
- Drain figs and rinse thoroughly with cold water. In a large pot combine the sugar and the 4 cups of water; bring to a boil and cook for 10 minutes.
- Add the figs and lemon slices to the syrup and cook over low heat for 1 hour, stirring occasionally.
- Sterilize canning jars and lids in boiling water for at least 10 minutes.
- Carefully spoon figs into hot, sterilized jars and spoon syrup over figs, leaving 1/2 inch of head space. Top jars with lids and screw bands on tightly.
- Follow the instructions for “How to use the Pressure Cooker for CANNING” in this manual and process sealed jars for 10 minutes in a boiling water bath.
- When the unit has reached optimum pressure, it will begin to pressure-seal the mason jars. The programmed time will begin to count down until it reaches zero.
- When time has expired, the pressure cooker will beep and automatically go to Keep Warm.
- The Keep Warm indicator light will illuminate. This indicates the Pressure Cooker is Naturally Releasing the pressure. (See Notes & Tips #5)
- Open lid once pressure has completely released.
- Carefully remove jars using special canning utensils or tools. **CAUTION: Jars are hot!**
- Set jars on a towel or cooling rack and allow to cool completely in a draft-free location.

## FRESH GARDEN SALSA

### *Ingredients*

7 cups of fresh tomatoes, peeled, cored, seeded and diced	½ cup of vinegar
6 green onions, sliced	2 Tbsp lime juice
2 or 3 jalapeno peppers, diced	4 drops of hot pepper sauce
4 cloves of garlic, minced	2 Tbsp fresh minced cilantro
	2 tsp salt

### *Directions:*

- Sterilize canning jars and lids in boiling water for at least 10 minutes.
- Combine all ingredients in a large saucepan.
- Heat to a boil. Reduce heat and simmer 15 minutes.
- Ladle hot salsa in to hot jars leaving 1/2 inch headspace. Remove air bubbles. Wipe rim. Center hot lid on jar. Apply band and adjust until fit is fingertip tight.
- Follow the instructions for “How to use the Pressure Cooker for CANNING” in this manual, process filled jars for 15 minutes.
- When the unit has reached optimum pressure, it will begin to pressure-seal the mason jars. The programmed time will begin to count down until it reaches zero.
- When time has expired, the pressure cooker will beep and automatically go to Keep Warm.
- The Keep Warm indicator light will illuminate. This indicates the Pressure Cooker is Naturally Releasing the pressure. (See Notes & Tips #5)
- Open lid once pressure has completely released.
- Carefully remove jars using special canning utensils or tools. **CAUTION: Jars are hot!**
- Set jars on a towel or cooling rack and allow to cool completely in a draft-free location.
- Check lids for seal after 24 hours. Lid should not flex up and down when center is pressed.

## HOMEMADE DRIED APRICOT JAM

### *Ingredients*

4 ½ cups of dried apricots	1 1.75oz package of powdered fruit pectin
4 ½ cups of boiling water	7 cups sugar
1 tsp vanilla extract	¼ cup fresh lemon juice

### *Directions:*

- Soak apricots in boiling water in a bowl until hydrated, about 30 minutes. Blend apricots, remaining water, and vanilla extract in a food processor, working in batches, until blended but still slightly chunky.
- Combine apricot mixture with pectin in a large pot over medium heat; cook until just boiling. Add sugar and lemon juice; boil until sugar has dissolved, 1 to 2 minutes.
- Sterilize jars and lids in boiling water for at least 5 minutes. Pack the apricot jam into the hot, sterilized jars, filling the jars to within 1/4-inch of the top. Run a knife or a thin spatula around the insides of the jars after they have been filled to remove any air bubbles. Wipe the rims of the jars with a moist paper towel to remove any food residue. Top with lids, and screw on rings.
- Place a rack in the bottom of the pressure cooker cooking pot and fill halfway with water. Carefully lower the jars into the pot using a holder. Leave a 2-inch space

## CANNING RECIPES

between the jars. Pour in more boiling water if necessary until the water level is at least 1 inch above the tops of the jars.

- Follow the instructions for “How to use the Pressure Cooker for CANNING” in this manual and process sealed jars for 10 minutes in a boiling water bath.
- When the unit has reached optimum pressure, it will begin to pressure-seal the mason jars. The programmed time will begin to count down until it reaches zero.
- When time has expired, the pressure cooker will beep and automatically go to Keep Warm.
- The Keep Warm indicator light will illuminate. This indicates the Pressure Cooker is Naturally Releasing the pressure. (See Notes & Tips #5)
- Open lid once pressure has completely released.
- Carefully remove jars using special canning utensils or tools. **CAUTION: Jars are hot!**

Place onto a cloth-covered or wood surface, several inches apart, until cool, about 1 hour. Once cool, press the top of each lid with a finger, ensuring that the seal is tight (lid does not move up or down at all). Store in a cool, dark area.

**ITALIAN MEATBALLS**

SERVES 4

***Ingredients***

- |                        |                                |
|------------------------|--------------------------------|
| 1 lb. ground beef      | 1/2 lb. Italian sausage        |
| 2 eggs                 | 1/4 C. milk                    |
| 1/2 C. dry breadcrumbs | 3 Tbsp. grated parmesan cheese |
| 1/2 tsp. garlic powder | salt and pepper                |

In a bowl, beat eggs and add milk. Add beef and Italian sausage. Mix together. Add rest of ingredients and mix until combined. Shape the mixture into 1 inch balls and place on a greased cookie sheet. Bake at 350°F for 15 minutes. Add to pressure cooker.

**Sauce**

- |                           |                          |
|---------------------------|--------------------------|
| 1 15 oz. can tomato sauce | 1 6 oz. can tomato paste |
| 1 small onion chopped     | 1/2 C. green pepper      |
| 1/2 C. beef broth         | 1/3 C. water             |
| 2 garlic cloves minced    | 1 tsp. oregano           |
| 1 tsp. salt               | 1 tsp. sugar             |
| 1 2 tsp. pepper           |                          |

***Directions***

Mix all ingredients in a bowl and pour over the meatballs. Cover pressure cooker with the glass lid. Program to **SLOW COOK** for 4 - 5 hours.

**SLOPPY JOES**

SERVES 4

***Ingredients***

- |                          |                              |
|--------------------------|------------------------------|
| 3 lbs. ground beef       | 1 C. onions diced            |
| 1 C. celery diced        | 1 C. green pepper diced      |
| 1 1/2 C. ketchup         | 2 Tbsp. Worcestershire sauce |
| 1 6 oz. can tomato paste | 3/4 C. water                 |
| 1/2 tsp. paprika         | 3 Tbsp. vinegar              |
| 3 Tbsp. brown sugar      | 1 tsp. dry mustard           |
| salt and pepper          |                              |

***Directions***

Brown ground beef in the pressure cooker by following the **BROWNING** instructions. Add the rest of the ingredients and mix well. Cover with glass lid and program to **SLOW COOK** for 8 hours. Serve on hamburger buns.

## CHILI DIP

SERVES 2-3

### *Ingredients*

1 lb. ground beef	1 16 oz. jar mild picante sauce
2 cans refried beans	8 oz. sour cream
1/2 tsp. chili powder	1/2 C. chopped onion
8 oz. cheddar cheese shredded	Jalapenos or mild chilies to taste

### *Directions*

Brown ground beef and onion in the pressure cooker by following the **BROWNING** instructions. Drain and add back to pressure cooker. Add beans, picante sauce, jalapenos (if using) and chili powder. Program to **SLOW COOK** for 2 - 3 hours. Add cheese and sour cream last 1/2 hour.

Serve with tortilla chips.

## WILD MUSHROOM BEEF STEW

SERVES 3-4

### *Ingredients*

2 lbs. beef for stew, cut into 1-inch pieces	1/4 C. all-purpose flour
1 tsp. salt	1/2 tsp. pepper
1/2 tsp. dried thyme leaves, crushed	3/4 C. ready-to-serve beef broth
1/4 C. tomato paste	1/4 C. dry red wine
2 cloves garlic, minced	1 lb. red-skinned potatoes (1-1/2-inch diameter), cut into quarters
8 oz. assorted mushrooms, such as shiitake, cremini and oyster, cut into quarters	
1 C. baby carrots	Fresh parsley (optional)

### *Directions*

Combine flour, salt, pepper and thyme in small bowl. Place beef into pressure cooker. Sprinkle with flour mixture; toss to coat.

Combine broth, tomato paste, wine and garlic in small bowl; mix well. Add to beef. Add potatoes, mushrooms and carrots; mix well.

Cover with glass lid and program to **SLOW COOK** for 8 to 9 hours, or until beef and vegetables are tender. (No stirring is necessary during cooking.) Stir well before serving. Garnish with parsley, if desired.

## POT ROAST

SERVES 6

### *Ingredients*

3 - 4 lb. pot roast  
1 C. beef broth  
4 - 5 potatoes cut up

large onion cut up  
1 lb. carrots cut in 2 inch pieces  
salt and pepper

### *Directions*

Brown pot roast in the pressure cooker by following the **BROWNING** instructions. Once browned, remove pot roast from inner pot. Add vegetables to the pressure cooker. Top with roast and pour beef broth over it. Salt and pepper to taste.

Cover with glass lid and program to **SLOW COOK** for 8 hours.

## BBQ MEATLOAF

SERVES 4

### *Ingredients*

2 - 2 1/2 lbs. ground beef  
1 egg  
2 tsp. Worcestershire sauce  
1/2 tsp. salt  
2 tsp. prepared mustard  
1 Tbsp. vinegar

3/4 C. barbecue sauce  
1 C. crushed soda crackers  
1/2 C. diced onion  
1/4 C. water  
2 Tbsp. brown sugar

### *Directions*

Mix all ingredients in a large bowl. Form into a meatloaf shape that will fit into your pressure cooker. Cut a strip of foil to go under the meatloaf in the pressure cooker, leaving it long enough so that you can use it to lift the meatloaf out when it is finished cooking.

After placing the meatloaf in pressure cooker, top the meatloaf with an additional 1/3 C. barbecue sauce. Cover with glass lid and program to **SLOW COOK** for 8 - 9 hours.

## CHICKEN MERLOT WITH MUSHROOMS

SERVES 4

### *Ingredients*

2 1/2 to 3 lbs. boneless, skinless chicken thighs  
2 garlic cloves, peeled and minced  
1 6-oz. can tomato paste  
2 Tbsp. quick-cooking tapioca  
2 Tbsp. chopped fresh basil  
1/4 tsp. salt  
2 C. cooked noodles

12 oz. sliced fresh mushrooms  
1 large onion, peeled and chopped  
3/4 C. low-sodium chicken broth  
1/4 C. Merlot or any dry red wine, or additional chicken broth  
2 tsp. granulated sugar  
1/4 tsp. freshly ground black pepper  
2 Tbsp. freshly grated Parmesan cheese

*Directions*

Rinse chicken, pat dry and set aside.

Place the mushrooms, onion and garlic in the pressure cooker. Place the chicken pieces on top of the vegetables.

Combine broth, tomato paste, wine, tapioca, dried basil (if using), sugar, salt and pepper in a medium bowl. Pour mixture over the chicken and vegetables.

Cover with glass lid and program to **SLOW COOK** for 7 to 8 hours.

To serve, spoon chicken mixture over cooked noodles. Sprinkle with Parmesan cheese.

**CHICKEN WINGS IN HONEY SAUCE**

SERVES 2-3

***Ingredients***

3 pounds chicken wings (16 wings)

2 cups honey

1/2 cup ketchup

2 cloves garlic, minced

salt and pepper to taste

1 cup soy sauce

1/4 cup oil

*Directions*

Rinse chicken and pat dry. Cut off and discard wing tips. Cut each wing at joint to make two sections. Sprinkle wing parts with salt and pepper.

Place wing parts on broiler pan. Broil 5-4 inches from heat 20 minutes, 10 minutes a side or until chicken is brown. Transfer chicken to pressure cooker.

For sauce, combine honey, soy sauce, ketchup, oil and garlic in bowl. Pour over chicken wings.

Cover with glass lid and program to **SLOW COOK** for 4-5 hours.

**SOUTHWESTERN CHICKEN**

SERVES 6

***Ingredients***

1 (15-oz) can whole kernel corn, drained

1 (15- oz) can black beans, rinsed and drained

6 boneless, skinless chicken breast halves, rinsed and dried

Flour tortillas

1 (11- oz) can Mexicorn, drained

1 (16- oz) jar chunky salsa (divided use)

Shredded cheddar cheese

*Directions*

Combine the cans of corn, beans and half the salsa in pressure cooker. Top with the chicken. Pour remaining sauce over.

Cover with glass lid and program to **SLOW COOK** for 9.5 hours or until meat juices run clear. Serve with warm tortillas; top with cheese.



## CHICKEN PAPRIKA WITH DUMPLINGS

SERVES 6-8

### *Ingredients*

6 boneless, skinless chicken breasts	1 medium onion chopped
1 tsp. salt	1/2 tsp. black pepper
1 Tbsp. Hungarian paprika	1 cup chicken broth
8 ounces sour cream	1 Tbsp. cornstarch or flour

### **Dumpling Ingredients:**

3 eggs	1/3 cup water
2-1/2 cups all-purpose flour, sifted	

### *Directions*

Add onions to pressure cooker. Add seasonings, chicken and broth.

Cover with glass lid and program to **SLOW COOK** for 5 to 6 hours.

Shortly before serving, stir together sour cream and cornstarch. Remove glass lid and follow

**BROWNING** instructions and stir mixture into pressure cooker and heat through.

Taste and adjust seasonings (sour cream and cornstarch may be omitted if desired). Serve with dumplings (recipe below)

### *Dumplings Instructions*

Beat 3 eggs, add 1/3 cup water and 2-1/2 cups flour. Beat with a spoon until smooth. Drop from teaspoon into boiling salted water and cook until dumplings rise to the top, approximately 10 minutes.

## CHEESY SHRIMP PASTA

SERVES 3

### *Ingredients*

1 (2-lb.) block Velveeta cheese	1 (16-oz.) carton half-and-half
1 (8-oz) Canned Chopped Tomatoes	1 small onion, chopped
4 pods garlic, minced	1 lb. raw shrimp
Cooked pasta of choice	

### *Directions*

Place cheese, half-and-half, tomatoes, onion and garlic in pressure cooker. Cover with glass lid and program to **SLOW COOK** for 4 hours.

Add shrimp and **SLOW COOK** for another 90 minutes or until shrimp are pink.

Cook pasta of choice and spoon sauce over cooked pasta.

## SALMON BAKE

SERVES 3

### *Ingredients*

2 cans salmon, boned and skinned (15 oz. size)	4 cups bread crumbs
1 tsp. lemon juice	1 (8-oz.) can tomatoes
1 chopped green bell pepper	1 (8-oz.) can cream of onion soup
1 can cream of celery soup	4 well beaten eggs
1 tsp. garlic powder	1 teaspoon Greek seasoning
2 chicken bouillon cubes, crushed	1/4 cup milk

### *Directions*

Combine all ingredients except celery soup and milk. Pour into pressure cooker. Cover with glass lid and program to **SLOW COOK** for 5 hours.

Combine cream of celery soup with 1/2 cup of milk and heat in saucepan. Use as a sauce for salmon bake.

## BAKED STUFFED APPLES

SERVES 6

### *Ingredients*

6 medium red tart apples	1 C. light brown sugar
1/4 C. raisins	1 Tbsp. orange peel
1/4 C. butter	2 C. very hot water
3 Tbsp. orange juice concentrate	

### *Directions*

- Wash and core the apples, but don't peel them. In a pan that will fit in your pressure cooker, stand the apples up. Butter the pan first.
- Fill the core cavities with the brown sugar, raisins and orange peel. Top with butter.
- Place the pan in the pressure cooker. Pour the hot water around the pan. Sprinkle the orange juice concentrate over the apples.
- Cover with glass lid and program to **SLOW COOK** for 5 hours. for 3 - 5 hours or until apples are tender.

## PIÑA COLADA BREAD PUDDING

SERVES 4

### *Ingredients*

1 lb. loaf French bread	10 oz. frozen piña colada drink mix
6 oz. pineapple juice	12 oz. evaporated milk
1/2 C. cream of coconut	2 large bananas; sliced
3 eggs	1/4 C. light rum
1 C. raisins	8 oz. pineapple; crushed w/juice
1 t. lemon peel; grated	fresh mint sprigs

### *Directions*

- With a sharp knife, peel crust from bread; discard crust or make into bread crumbs for use in another recipe. Cut bread into 1-inch cubes; set aside. In blender or food processor, fitted with a metal blade, combine 1/2 of the following ingredients; drink mix, pineapple juice, evaporated milk, cream of coconut, and banana slices.
- Process until pureed; pour puree into a 6-cup bowl. Puree remaining 1/2 of liquid ingredients and banana slices as well as eggs and liqueur, if desired.
- Combine both purees; set aside. Combine raisins and crushed pineapple (and the juice); set aside. Place about 2/3 of bread cubes in pressure cooker, sprinkle with 1/2 t. grated lemon peel and spread 1 cup of the raisin-pineapple mixture over bread in pressure cooker. Top with remaining bread cubes, then with remaining 1/2 t. lemon peel and raisin-pineapple mixture. Pour pureed ingredients into pressure cooker.
- Cover with glass lid and program to **SLOW COOK** for 6 hours. Spread pudding into 8 or 10 dessert dishes and serve hot. Garnish with fresh mint sprigs.

## BLUEBERRY BUMP CAKE

SERVES 6

### *Ingredients*

2 21 oz. cans blueberry pie filling	2 packages yellow cake mix
1 C. butter	1 C. chopped walnuts

### *Directions*

Place pie filling in the pressure cooker. Combine dry cake mix and butter, sprinkle over filling. Sprinkle the walnuts on top of that. Cover with glass lid and program to **SLOW COOK** for 2 - 3 hours. Serve warm in bowls.

Top with whipped cream or vanilla ice cream.

**LIMITED WARRANTY\* ONE (1) YEAR**  
**WARRANTY IS ONLY VALID WITH A DATED PROOF OF PURCHASE**

**PLEASE DO NOT RETURN TO STORE.**

**If you have any problems with this unit, contact Consumer Relations for service**

1. Your small kitchen appliance is built with precision, inspected and tested before leaving our factory.
2. It is warranted to the original purchaser to be free from any manufacturing defects under normal use and conditions for one (1) year, cord excluded. This Warranty applies only to the original purchaser of this product.
3. Retail stores/merchants selling this product do not have the right to alter, modify, or in any way revise the terms and conditions of the warranty.
4. If you use your appliance for household use and according to instructions, it should give you years of satisfactory service.
5. At its sole discretion, Maxi-Matic USA will either repair or replace the product found to be defective during the warranty period.
6. The repaired or replacement product will be in warranty for the remaining balance of the one-year warranty period and an additional one-month period.
7. Consumer's remorse is not an acceptable reason to return a product to our Service Center.
8. **This limited warranty covers appliances purchased and used within the 50 U.S. states plus the District of Columbia and does NOT cover normal wear of parts or:**
  - Damages caused by unreasonable use, neglect, normal wear and tear, commercial use, improper assembly or installation of product.
  - Damages caused in shipping.
  - Damages caused by replacement or resetting of house fuses or circuit breakers.
  - Defects other than manufacturing defects.
  - Breakage caused by misuse, abuse, accident, alteration, lack of proper care and maintenance, or incorrect current or voltage.
  - Lost or missing parts of the product. Parts will need to be purchased separately.
  - Damages of parts that are not electrical; i.e. cracked or broken plastic/glass, scratched/dented inner pots.
  - Damage from service or repair by unauthorized personnel.
  - Extended warranties purchased via a separate company or reseller.
  - Acts of God such as fire, floods, hurricanes, tornadoes, etc.

Maxi-Matic, USA shall not be liable for any incidental or consequential damages caused by the breach of any express or implied warranty. Apart from the extent prohibited by applicable law, any implied warranty of merchantability or fitness for a particular purpose is limited in time to the duration of the warranty.

\*One Year Limited Warranty valid only in the **50 U.S. states plus the District of Columbia, excluding** Puerto Rico and the Virgin Islands.

This warranty is effective only if the product is purchased and operated in the USA; product usage which is in violation of the written instructions provided with the unit will void this warranty.

This warranty gives you special legal rights and you may also have other rights to which you are entitled which may vary by state, province, and/or jurisdiction.

For international warranty, please contact the local distributor.

\*\*Any instruction or policy included in this manual may be subject to change at any time.

**MAXI-MATIC, USA**

18401 E. Arenth Ave. City of Industry, CA 91748

Customer Service Dept: (626) 912-9877 Ext: 120/107 MON-FRI 8am-5pm PST

Website: [www.maxi-matic.com](http://www.maxi-matic.com) email: [info@maxi-matic.com](mailto:info@maxi-matic.com)

**RETURN INSTRUCTIONS**

## RETURNS:

- A. Any return of defective merchandise to the manufacturer must be processed accordingly by first contacting customer service (info@maxi-matic.com) to obtain an RA # (Return Authorization Number). We will not accept any returns of merchandise without an applicable RA #.
- B. IMPORTANT RETURN INSTRUCTIONS. Your Warranty depends on your following these instructions if you are returning the unit to Maxi-Matic, USA:
1. Carefully pack the item in its original carton or other suitable box with sufficient cushioning to avoid damage in shipping.
  2. Before packing your unit for return, be sure to enclose:
    - a) Your name, full address with zip code, daytime telephone number, and RA#,
    - b) A dated sales receipt or PROOF OF PURCHASE,
    - c) The model number of the unit and the problem you are having (Enclose in an envelope and tape directly to the unit before the box is sealed,) and
    - d) Any parts or accessories related to the problem.
  3. Maxi-Matic, USA recommends that you ship the package via UPS ground service for tracking purposes. **We cannot assume responsibility for lost or damaged products returned to us during incoming shipment.** For your protection, always carefully package the product for shipment and insure it with the carrier. C.O.D shipments cannot be accepted.
  4. **All return shipping charges must be prepaid by you.**
  5. Mark the outside of your package:  
MAXI-MATIC USA  
18401 E. ARENTH AVE.  
CITY OF INDUSTRY, CA 91748
  6. Once your return has been received by our warehouse, Maxi-Matic, USA will repair or replace the product if it is defective in material or workmanship, subject to the conditions in paragraph B.
  7. **Maxi-Matic will pay the shipping charges to ship the repaired or replacement product back to you.**