

2 door sliding wardrobe

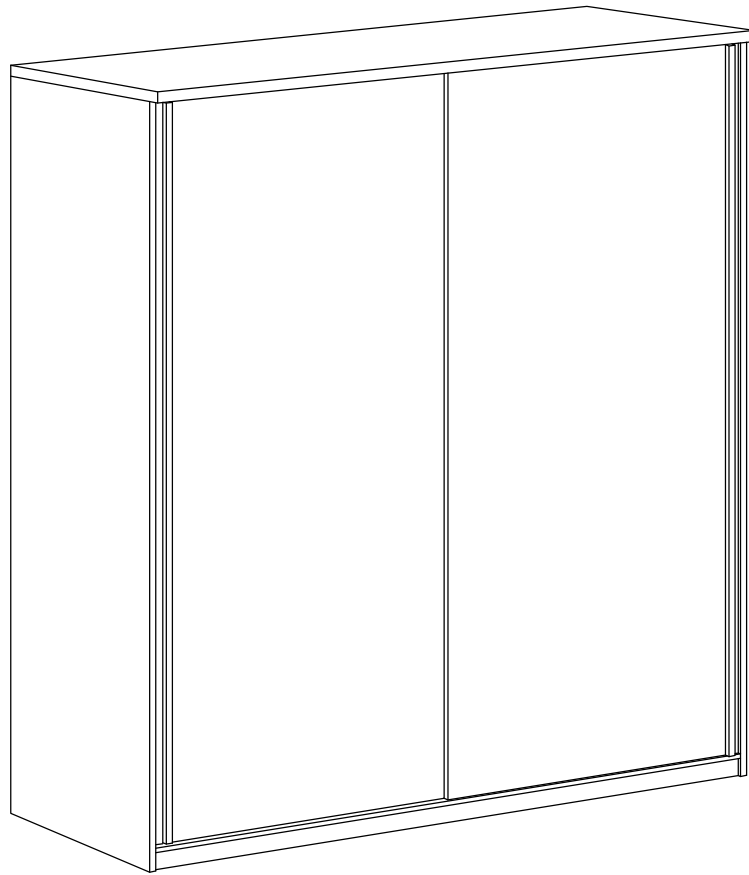

Please read these instructions before use and retain for future reference

If you need help with this product, please
contact our helpline on
Freephone 0870 160 1490
Your statutory rights are not affected.

Produced in the Czech Republic

Caution!

- Adult assembly required.
- Two-person assembly recommended.
- This item contains small parts that have sharp points and edges in the unassembled state. Keep away from children.
- Always place furniture on a firm level base.
- Do not stand or jump on this furniture.
- Do not assemble this furniture with a power tool.
- After assembly dispose of all packing materials safely.

Before assembly:

- Please read all instructions before beginning assembly.
- Please note this could be dangerous if incorrectly installed.
- Unpack and assemble this furniture, on a protective surface, in the room it will be used.
- Save all packing materials until assembly is complete to avoid accidentally discarding smaller parts or hardware.

Tools required

Cross head screwdriver (long reach)







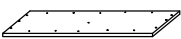
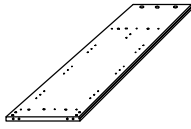
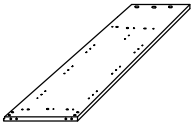
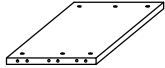
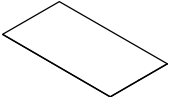
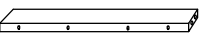
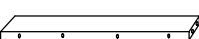
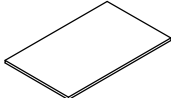
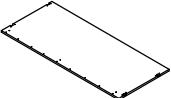
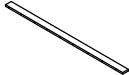
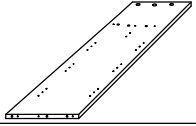

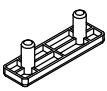
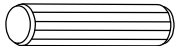

Pencil / Ruler / Spirit level / Masking tape / Hammer



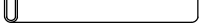

Drill fitted with a Ø 8mm drill bit (as required for the wall type)

Parts

					
Top panel	Bottom panel	Left side panel	Right side panel	Fixed shelf	Back panel
1	1	1	1	2	2
					
Front plinth	Back plinth	Adjustable shelf	Door	Door handle	Middle panel
1	1	2	2	2	1

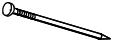
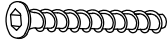
Fittings

					
Feet	Wooden dowel (Ø8x30mm)	Cam bolt	Cam lock (Ø15x12mm)	Cam bolt	Screw (Ø4x16mm)
6	56	21	27	3	28
					
Wall strap (12x150mm)	Underlay (Ø15mm)	Shelf support	Hanger rail support	Hanger rail (L=963mm)	Screw (Ø3x16mm)
1	1	8	4	2	1

m	n	o	p	q	r
					
Screw (Ø4x40mm)	Nail	Socket head screw (Ø7x50mm)	Socket head key (L 4mm)	Lower sliding fitting	Upper sliding fitting
10	100	3	1	4	4

Care Instructions

- Clean surface with a slightly damp cloth and wipe dry using a soft cloth.
- Do not use detergents, abrasive cleaning products or cleaning products which may contain ammonia or solvents, as these may damage the surface finish.
- To properly protect wood, it must not be exposed to excessive heat or humidity.
- Periodically check and tighten all fixings.

Check all parts and fittings are present before starting to assemble

In the unlikely event that the parts supplied are damaged or missing, please contact the helpline on 0870 160 1490 for a replacement. Your statutory rights are not affected.

Assembly

1

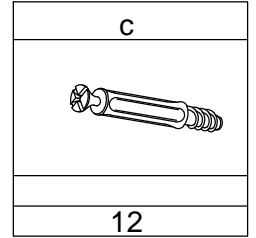
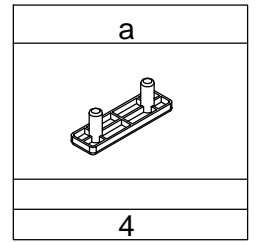
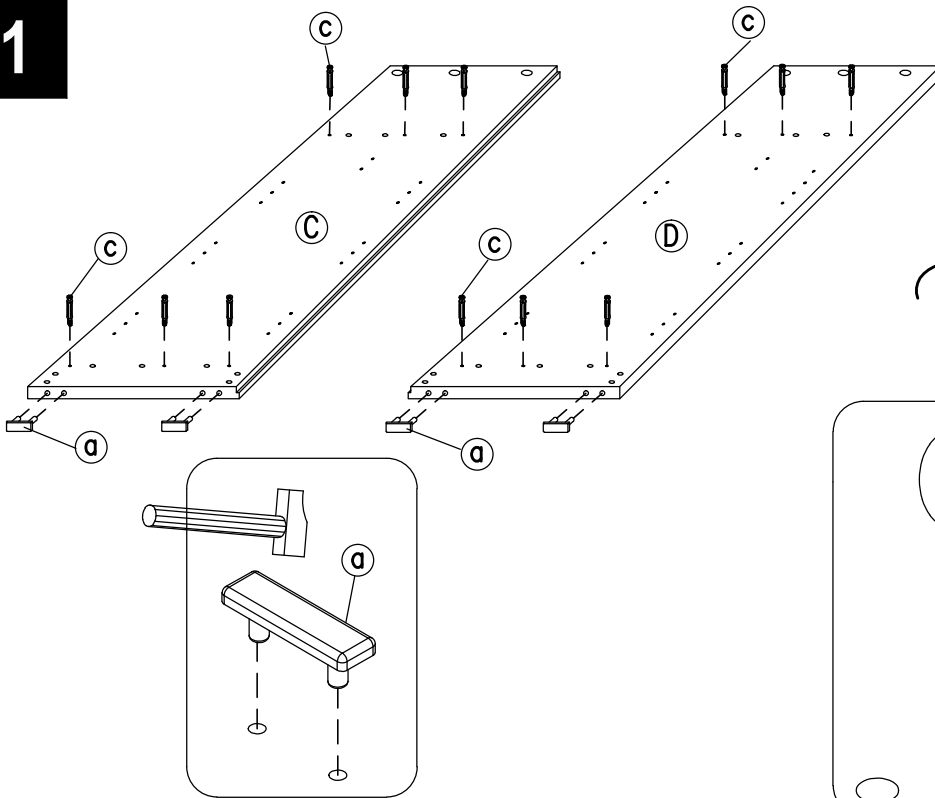

- Fit the cam bolt (c) to left / right side panels (C&D).
- Fit the feet (a) to left / right side panels (C&D).

2

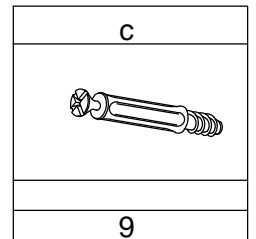
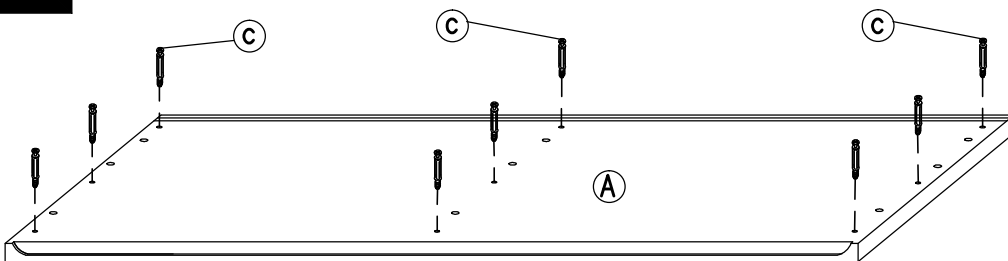

- Fit the cam bolt (c) to top panel (A).

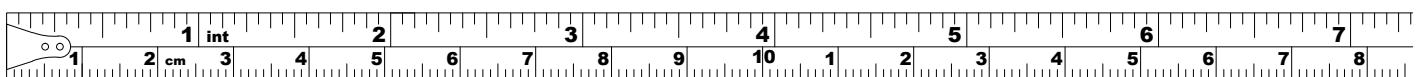

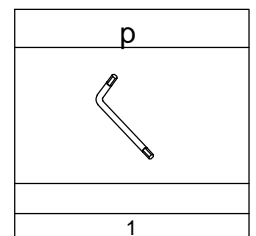
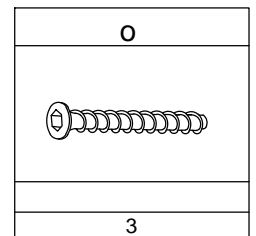
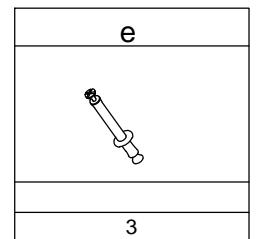
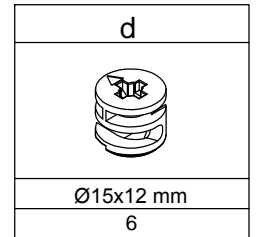
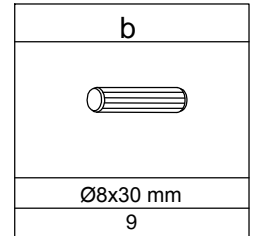
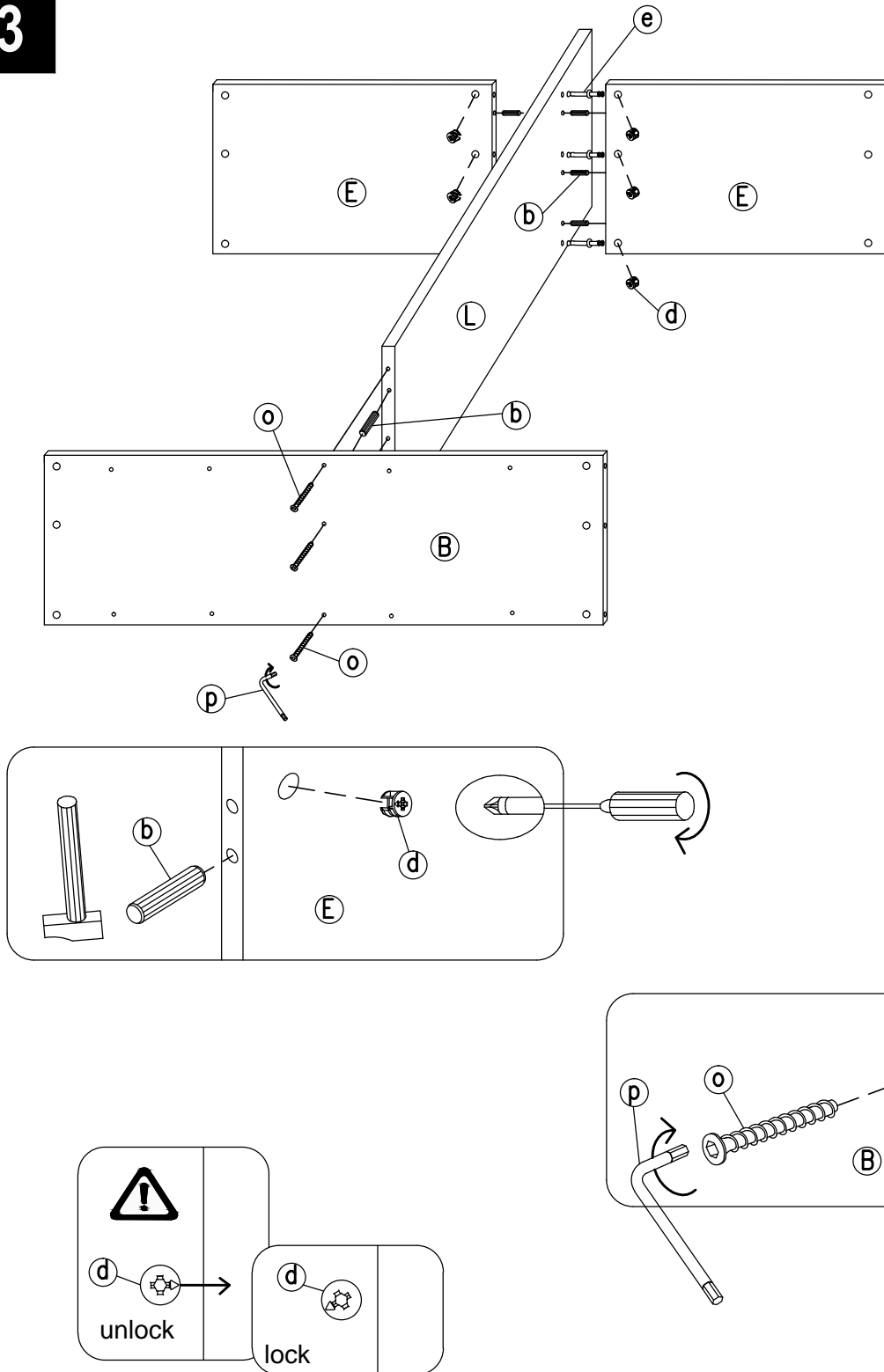

- Attach fixed shelf (E) to the middle panel (L) with wooden dowel (b), then insert cam lock (d) into the holes as pictured on the underside of panels and tighten.
- Attach bottom panel (B) to the middle panel (L) with wooden dowel (b), then insert socket head screw (o) using socket head key (p).

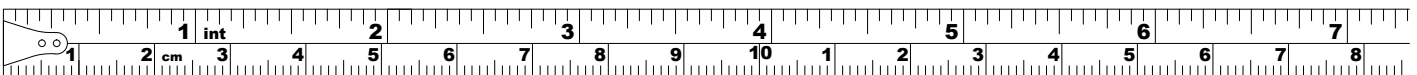

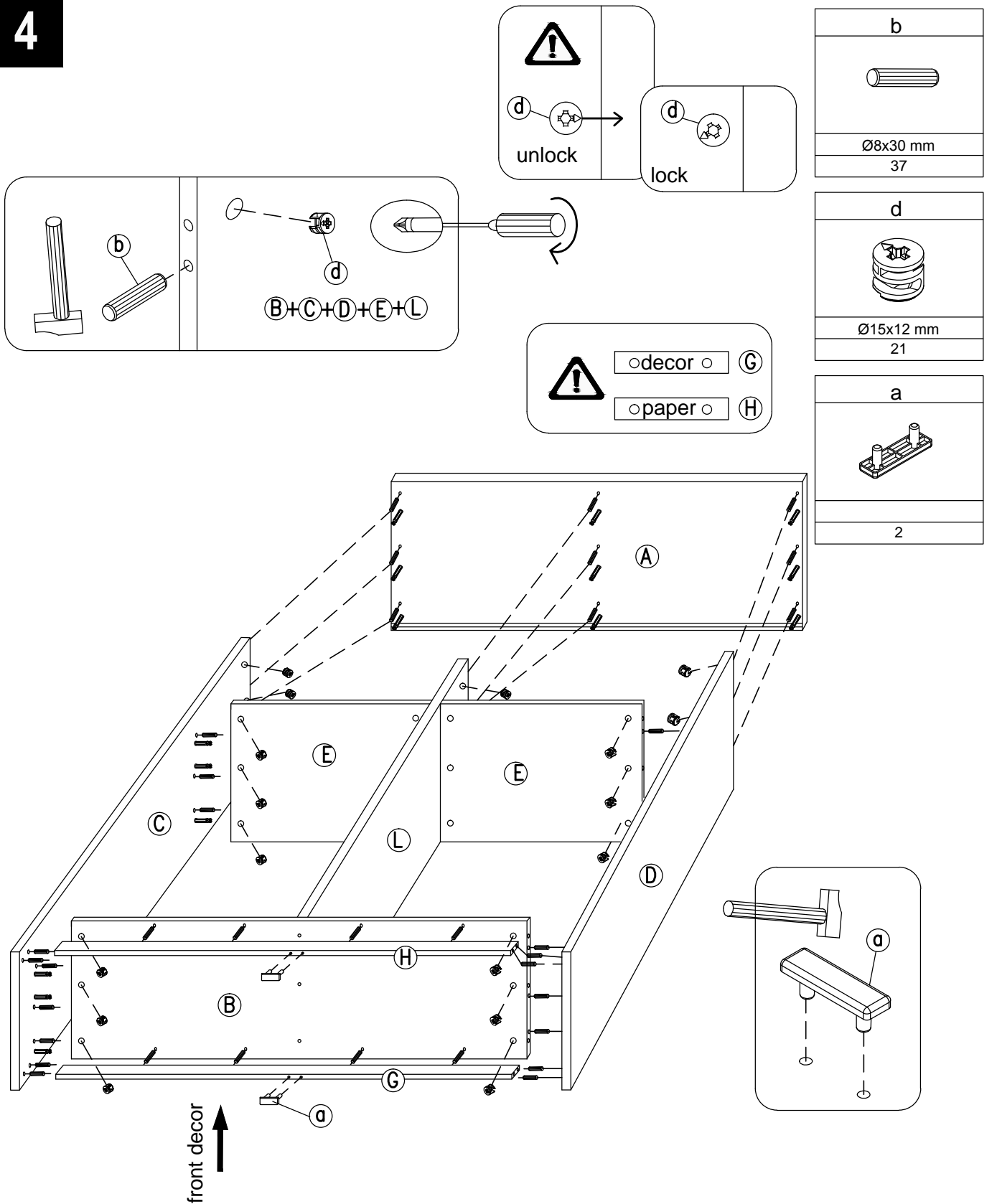

- Attach top panel (A), bottom panel (B) and fixed shelf (E) to the left / right side panel (C&D) with wooden dowel (b), then insert cam lock (d) into the holes as pictured on the underside of panels and tighten.
- Attach front plinth / back plinth (G&H) to the bottom panel (B) and the left / right side panel (C&D) with wooden dowel (b). Fit the feet (a) to front plinth / back plinth (G&H).

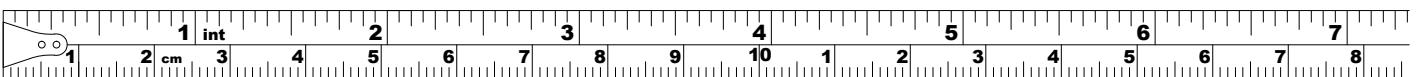

5

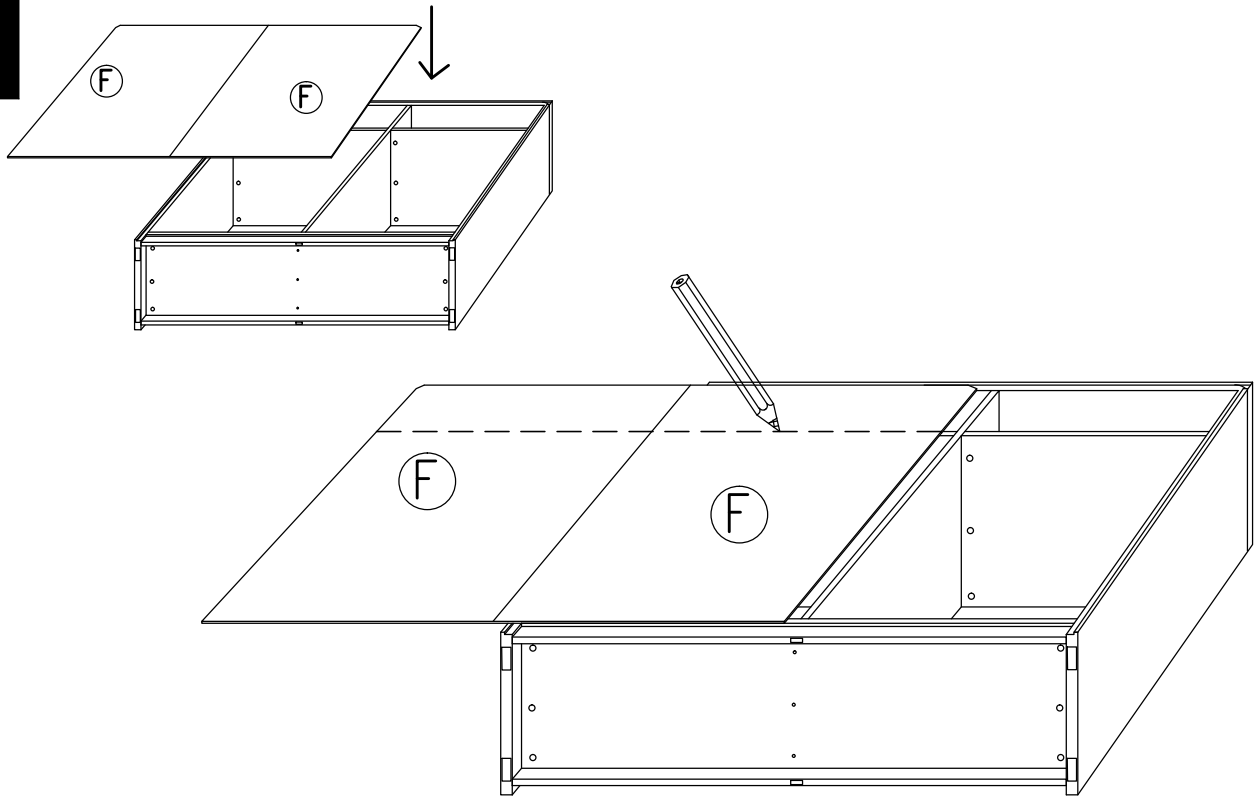

- Turn the carcass on the front. Put the back panel (F) between top and bottom panel and draw a line according to fixed shelf.

6

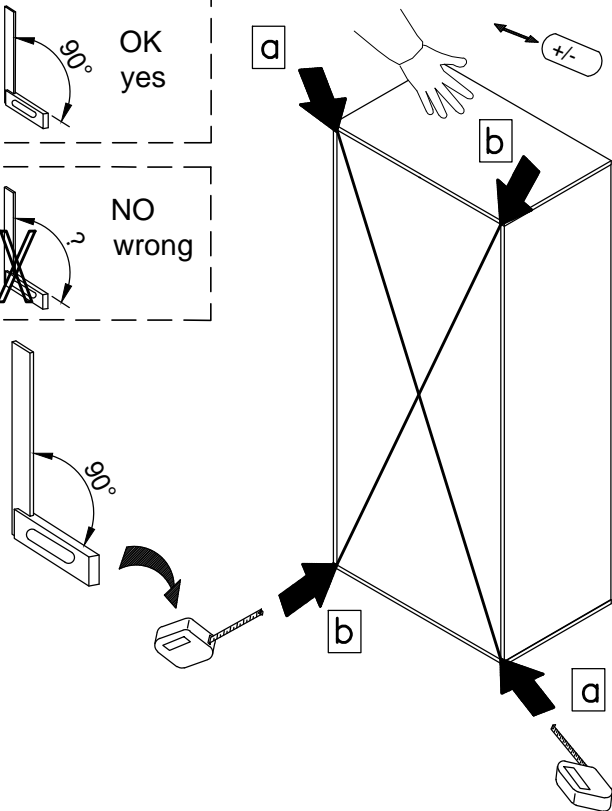
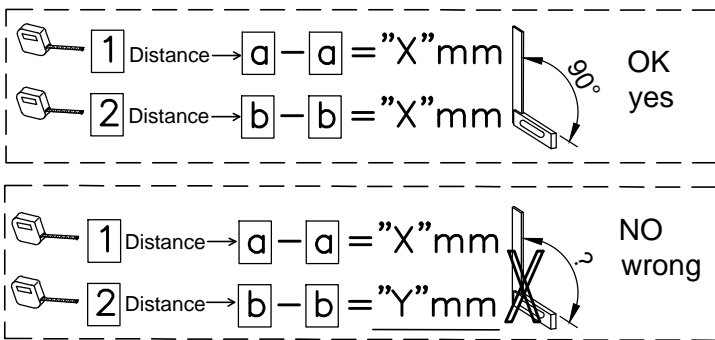

- Before fixing the back panel (F), the diagonal lines must be equal. ("a" to "a" and "b" to "b")

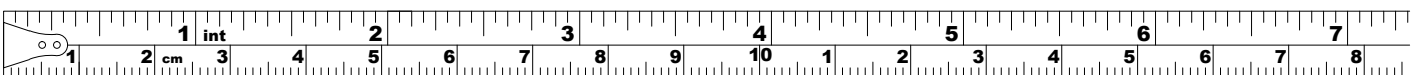

7

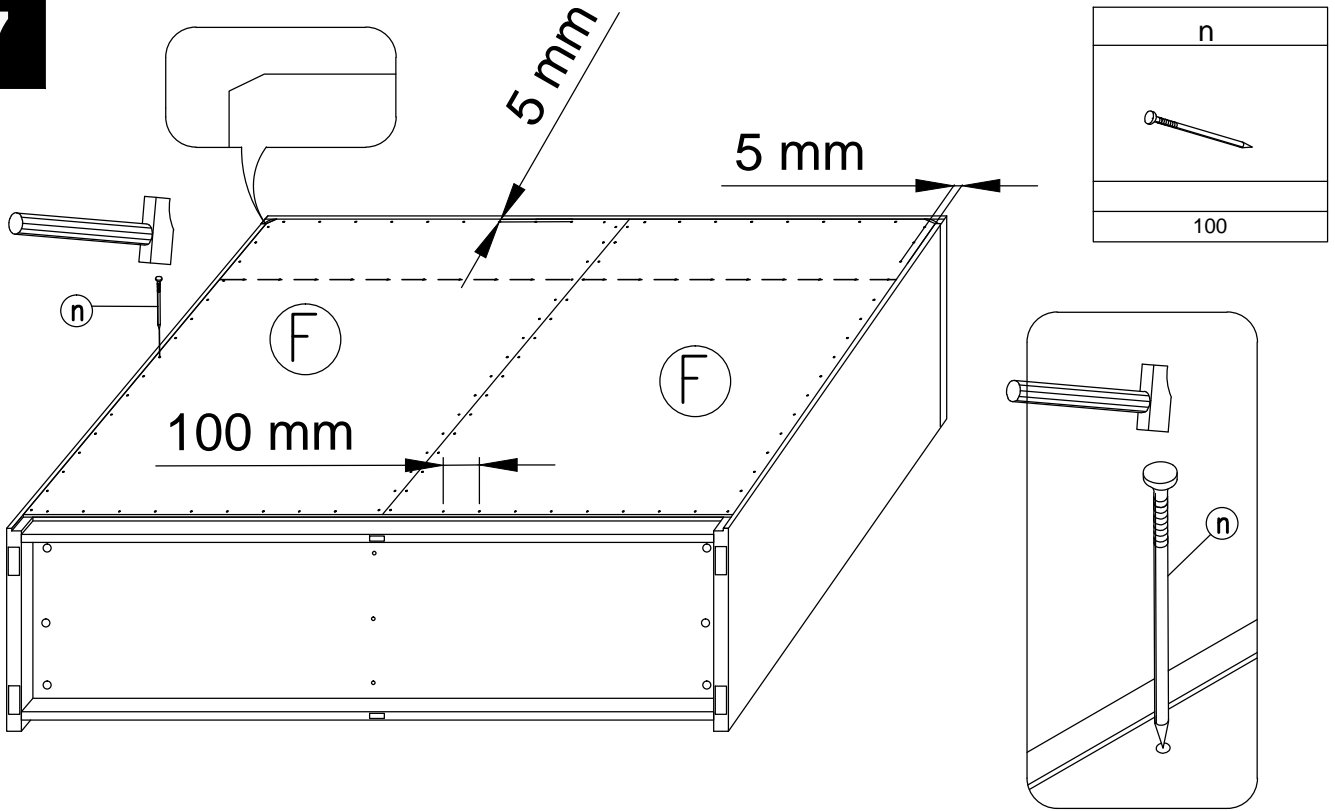

- Position nails (n) 5 mm in from side edge of the back panel with distance 100 mm between each other. Fix them using the hammer.

8

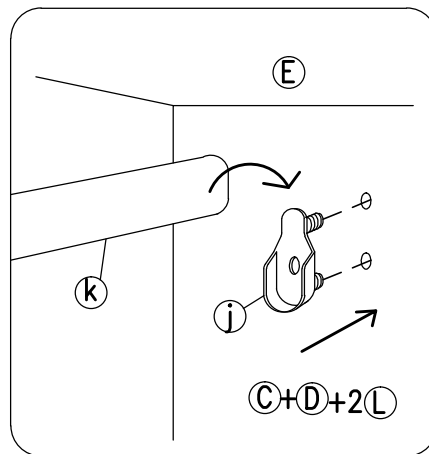
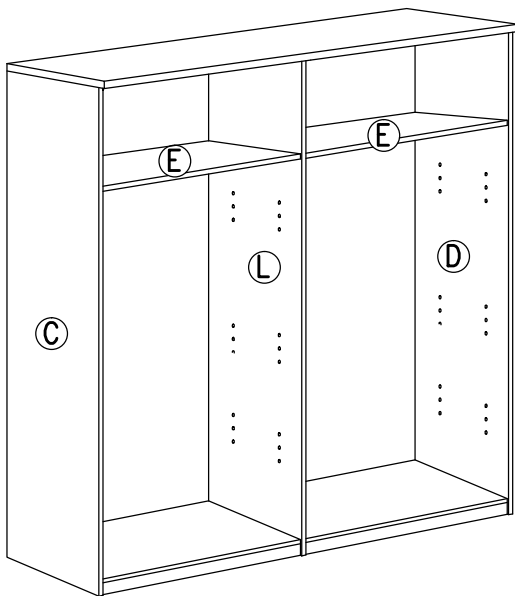

j
4
k
L=863mm
2

- Insert hanger rail support (j) and place the hanger rail (k).



9

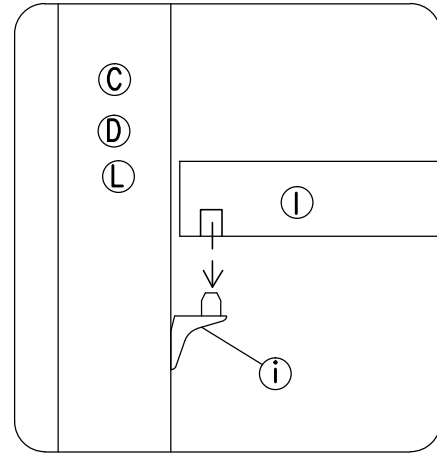
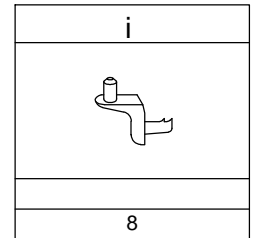
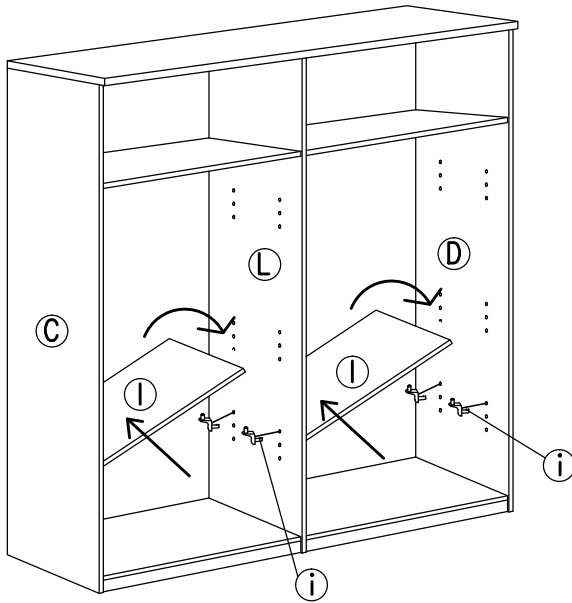

- Insert the shelf support (i) into the holes of left / right side panel at the desired height, then place the shelf (I) onto the support.

10

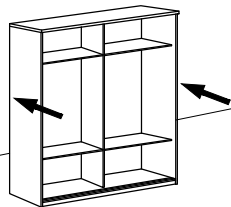

Warning: Before drilling, check wall for hidden pipes and cables. With help, move chest into position.



Warning: The wardrobe is heavy.
Lift with care.

- Mark fixing hole onto wall. Drill a hole and insert a suitable wall plug. Fix wall strap (h) using a suitable screw.
- **Note:** Wall fixings are not supplied with this unit.
- The correct type of fixing must be used for your wall, seek professional advice if in doubt.

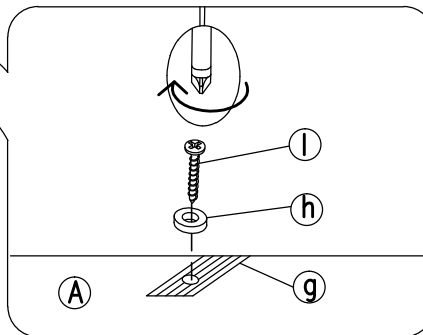
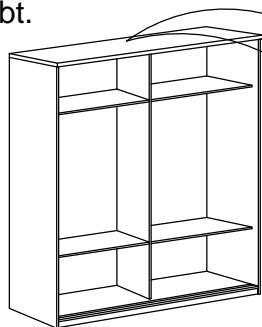
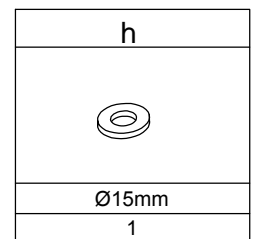
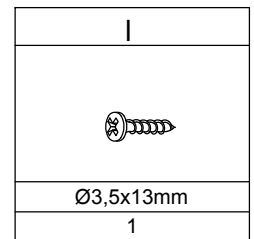
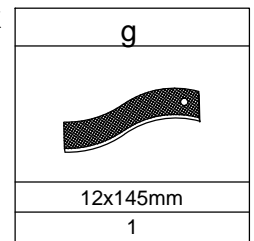

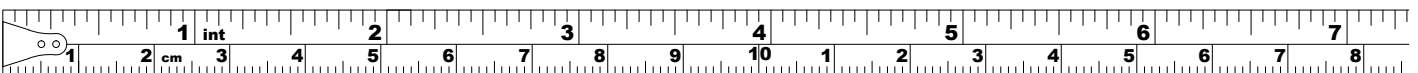

- Fit the wall strap (g) onto top panel using screw (f) and underlay (h).

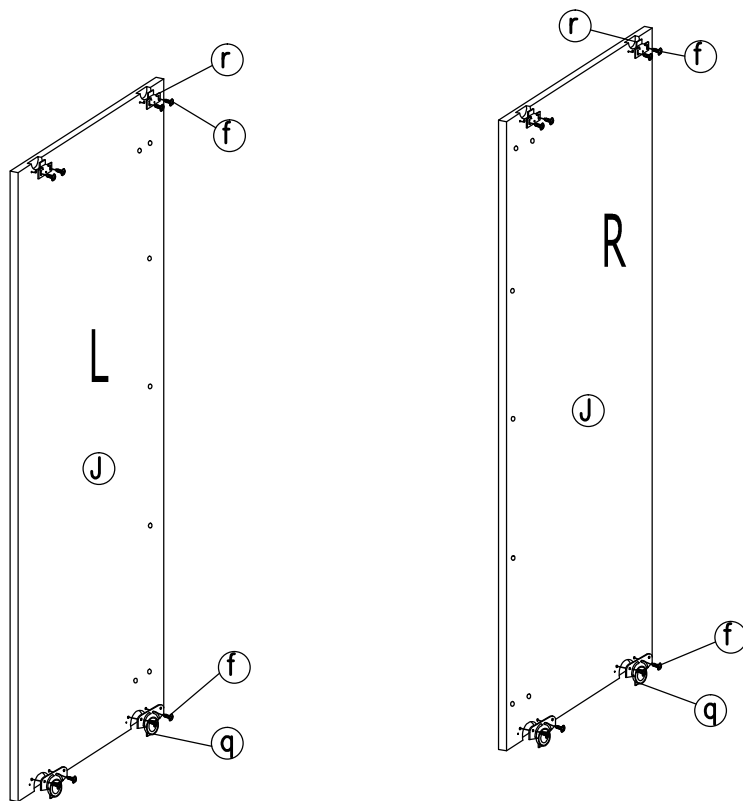



f

Ø4x16mm
16

q

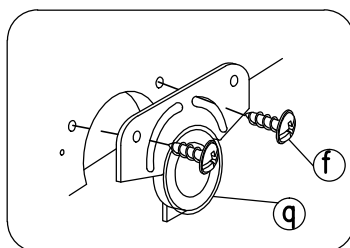
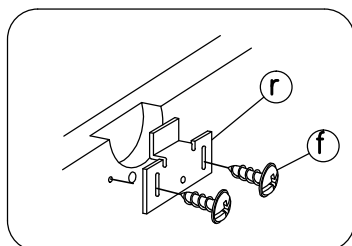
4

r

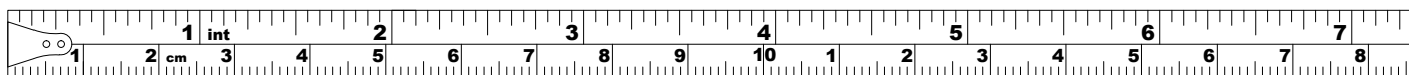
4



- Fit the upper and lower sliding fitting (q&r) to door panel (J) with screw (f). Do not tighten both fittings fully!

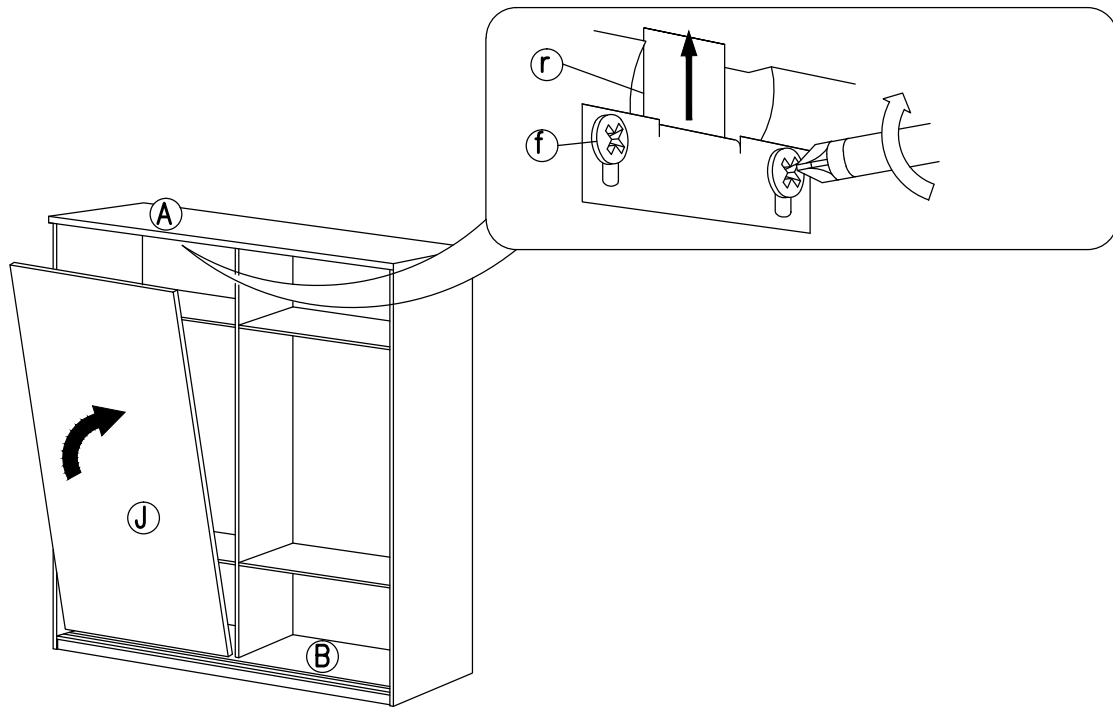

12



- Start with left door.
- Fit lower sliding fitting (q) into the groove in the bottom panel (B), cover the upper part of the door as pictured, then insert upper sliding fitting (r) into the groove in the top panel (A) and tighten.

13

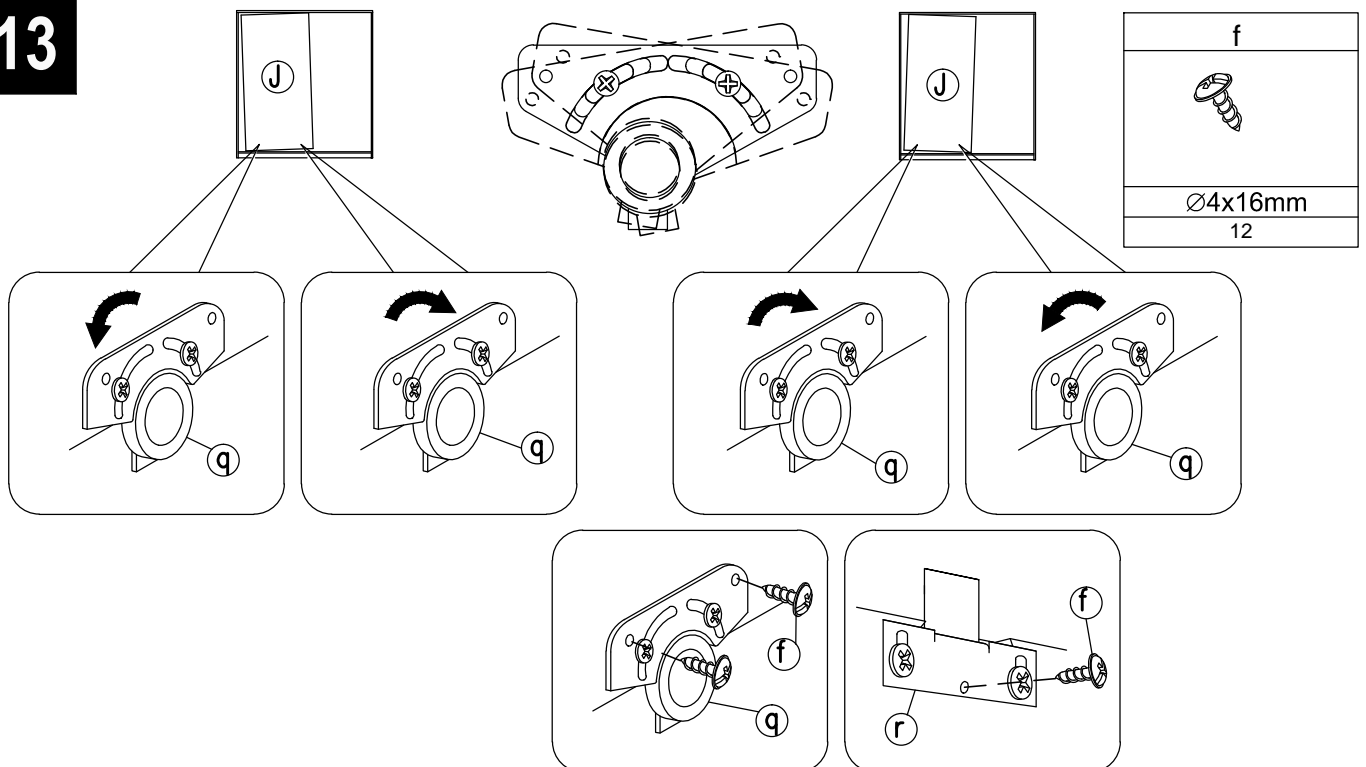

- Follow the pictures to adjust the level of the door. Once doors adjusted, secure with screws (f).
- Repeat the steps 12 and 13 for right door.

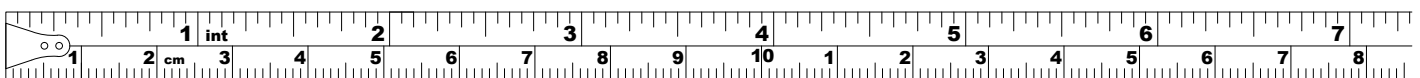

14

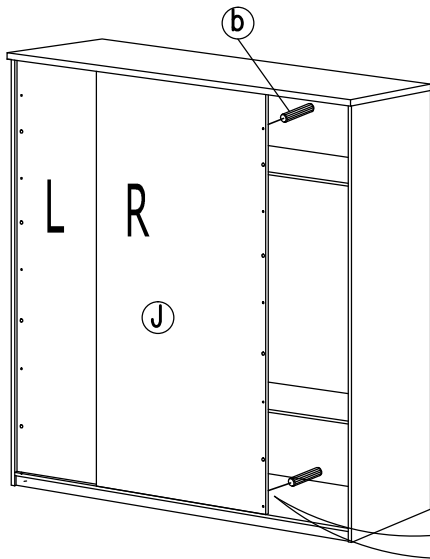

b

Ø8x30 mm
2



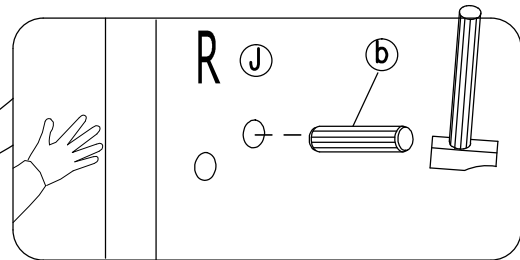

Warning

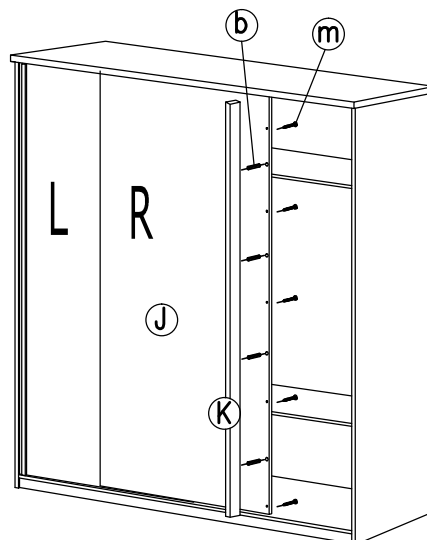
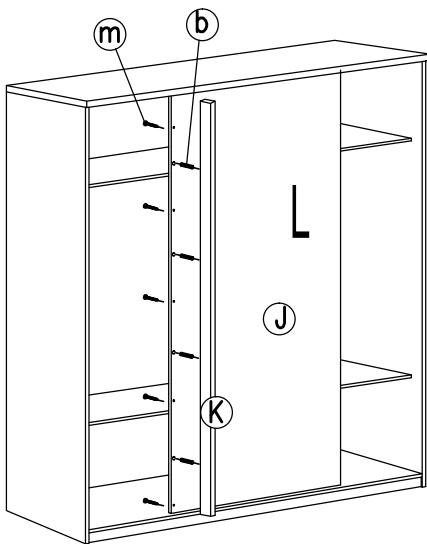

- CAREFUL! Insert the wooden dowel (b) into the back side of the right door (J).

15



b

Ø8x30 mm
8

m

Ø4x40mm
10

- Attach the door handle (K) to door (J) with wooden dowel (b) and screw (m).

