

CK094200TX

“VOGUE” END TABLE-CHROME

Assembly Instruction



For assistance with assembly contact:
Southern Enterprises Inc.
Customer Service 1-800-633-5096
service@seidal.com
www.seidal.com

Max Top Load: 50 lb.

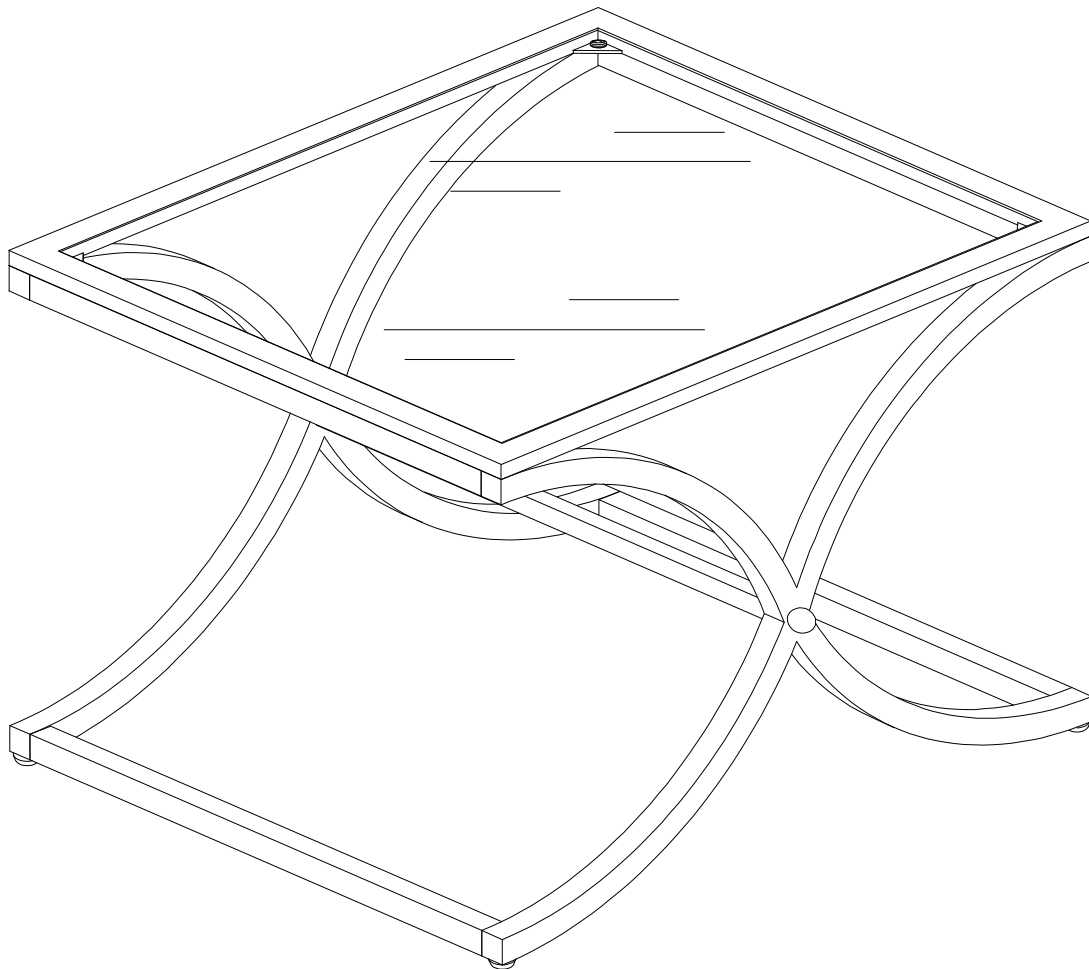





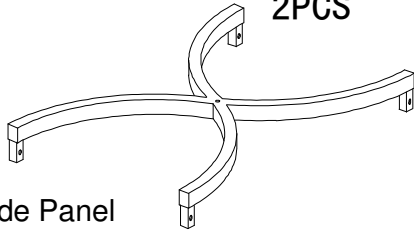
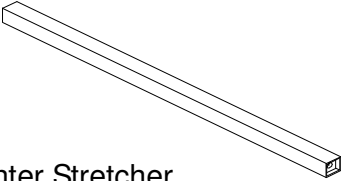
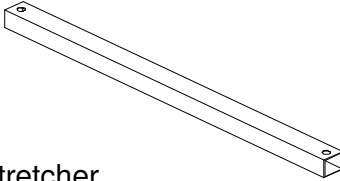
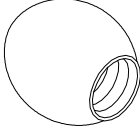
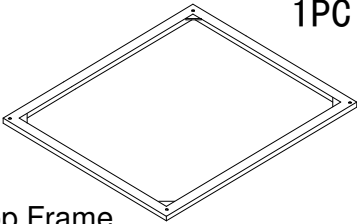
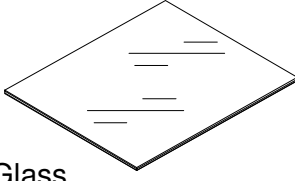

CK094200TX

“VOGUE” END TABLE - CHROME

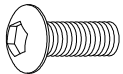
Parts List

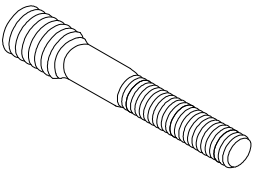
Please review all parts and hardware before disposing of any packaging. Call Customer Service if missing hardware. Do not return to store/retailer. Screws shown actual size. Using a screw that is too long will cause damage. Before beginning assembly, separate each type of screw. Carefully study the screw diagrams below.

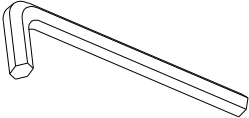
1  Side Panel 2PCS	2  Center Stretcher 1PC	3  Stretcher 4PCS	
4  Under Rod 2PCS	5  Top Frame 1PC	6  Top Glass 1PC	
A  Allen Bolt 1/4"x1/2" 8PCS	B  Allen Bolt 1/4"x1-1/2" 4PCS	C  Lock Washer 12PCS	D  Flat Washer 12PCS
E  Screw 2PCS	F  Leveler 4PCS	G  Glass Pad 4PCS	H  Screw 1PC

Care and Cleaning Instructions:
 Before using, wipe with a clean, dry cloth.
 Avoid rubbing or scratching the surface with rough or abrasive objects.

For replacement parts or questions, please Call Customer Service at 1-800-633-5096
 Do not return product to store, please call manufacturer for assistance, questions or parts.

Assembly Tool Required
No.2 Phillips Screwdriver

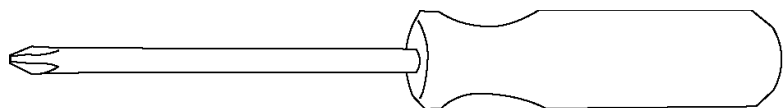

CK094200TX

“VOGUE” END TABLE- CHROME

Assembly Instruction

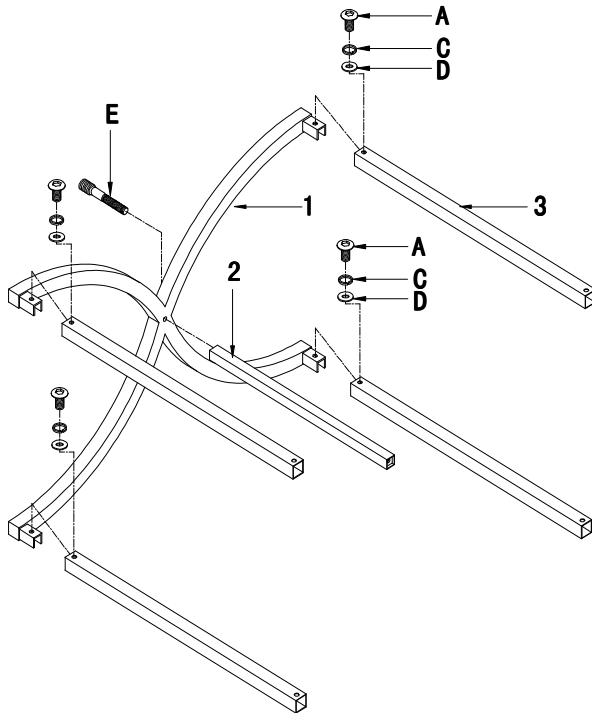

Figure 1

Step 1:

Attach stretcher (3) to side panel (1) by using bolt (A), lock washer (C), flat washer (D) as shown.

Attach center stretcher (2) to side panel (1) by using screw (E) as shown.

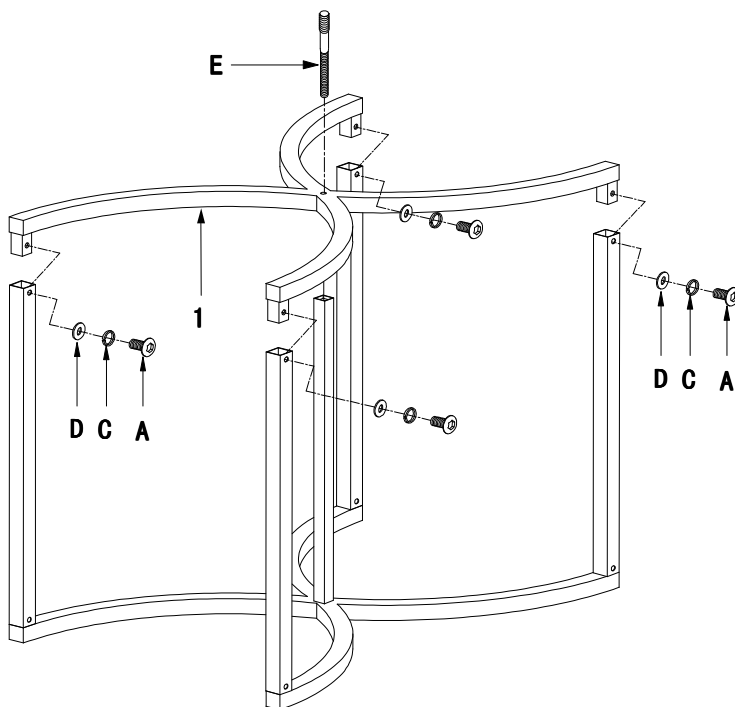

Figure 2

Step 2:

Attach side panel (1) to stretcher (3) by using bolt (A), lock washer (C), flat washer (D) and screw (E) as shown.

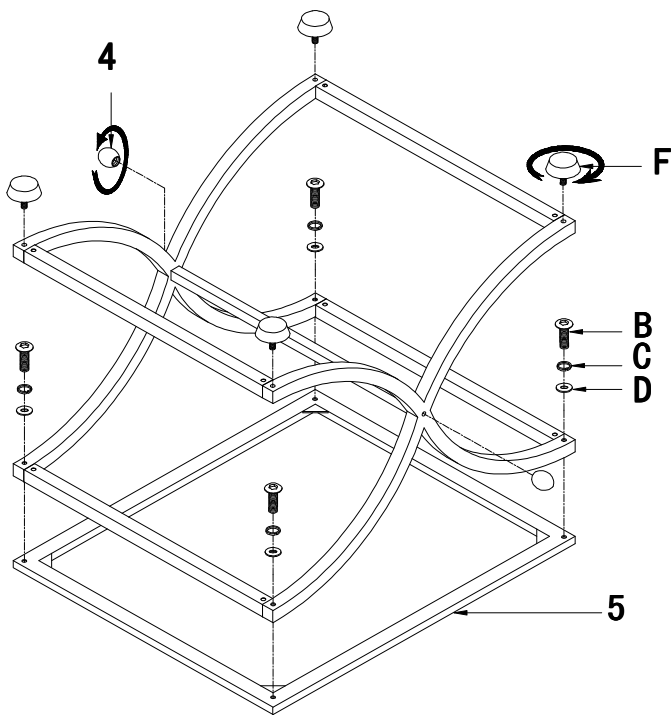

Figure 3

Step 3:

Assemble top frame (5) by using bolt (B), lock washer (C) and flat washer (D) as shown.

Tighten under rod (4) to panel and attached leveler (F) at the bottom of side panel as shown.

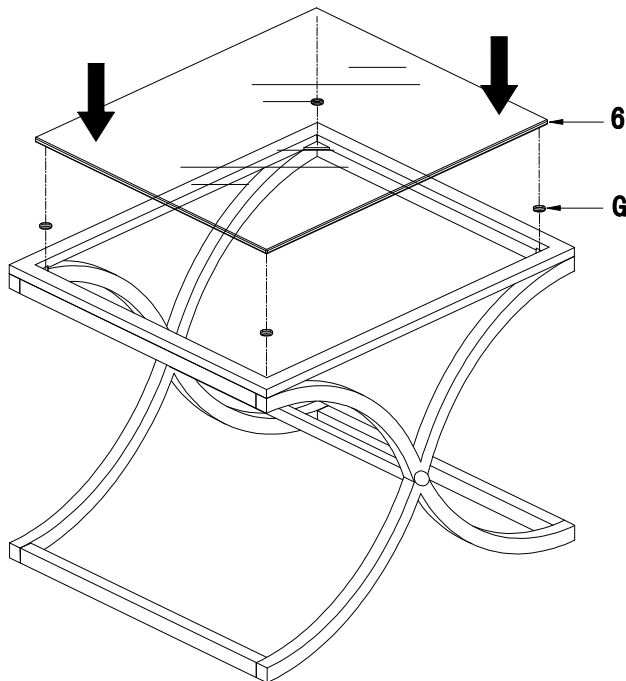

Figure 4

Step 4:

Turn the unit upside down and put glass pad (G) onto the frame as shown, then put on top glass (6).



Customer Service 1-800-633-5096
 service@seidal.com
 Southern Enterprises, Inc.
 600 Freeport Parkway Suite 200
 Coppell, Texas 75019

We'd love to hear from you! Email us photos of our products in your home at sei@seidal.com and we might feature it on our site or use it to model one of our inspirational photos.

“PARTS WILL BE SENT IF AVAILABLE FROM SEI” “THIS IS NOT A WARRANTY”

Parts Replacement Form

Customer Information

Name _____

Address _____

City/State/Zip Code _____

Phone Number _____

Please indicate where you purchased this item: Store/ Website/ Catalog

Please indicate color/size/style number:

Style No	Parts Letter	Parts Description	Quantity Needed

Please count, identify and compare parts and hardware list to be sure all parts are present. It may help to divide parts and label them to correspond with part list. Extra hardware may be included. If any items are missing, please contact Southern Enterprises at 800-633-5096 or in Dallas (972) 869-0111/ 9am – 4pm Mon-Fri Central time if you have product issues with your purchase. Please ask for a **customer service representative** for issues involving damages or replacement parts. Please ask for a **technical assistance representative** for any issues with product assembly and product construction. Please contact the retailer that you purchased from for returns.

Missing or damaged hardware and/ or parts will be replaced free of charge. We do not sell parts. We do not recommend modifying product(s) and we are not responsible for any damages due to product modification(s). If this product has not been purchased from our retail affiliates (within 9 months), we are under no obligation to provide parts or replacements merchandise. Parts will not be available for items arriving fully assembled.



Customer Service 1-800-633-5096

service@seidal.com

Southern Enterprises, Inc.

600 Freeport Parkway, Suite 200

Coppell, Texas 75019