

FURNITURE ASSEMBLY SERVICE



DID YOU KNOW...

WE CAN ASSEMBLE YOUR FLAT PACK FURNITURE FOR YOU!

We have recently introduced a furniture assembly service where, for a low price*, we'll arrange for our expert assembly team to visit your home and put your flat pack furniture together while you sit back and relax!**.

All of our assemblers are highly skilled and experienced, meaning your new furniture will be built and ready to use in next to no time, No mess, no fuss.

If you've already purchased an item of furniture from us and would like us to assemble it for you, or if you'd like to find out more about our assembly service for future furniture purchases, simply...

- Go to the website of the brand you ordered your new furniture from
- Type assembly service into the search box and click search

Here you'll find everything you need to know about our assembly service plus details of how to order the service online.

*Assembly service price is per item and is dependent on the item to be assembled. ** We regret that this service is not available for residents of the Isle of Man, Republic of Ireland or the Shetland Islands

SHOP
DIRECT

ASSEMBLY INSTRUCTION

DESCRIPTION:
22.WUUT.48
5+5 DRW CHEST

1,5 hrs

APPROXIMATE ASSEMBLY TIME

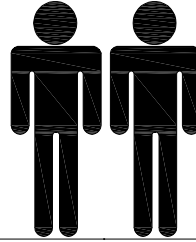

2 PERSON ASSEMBLY

FLOOR AREA
3.5M X 2.0M

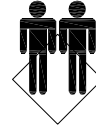

CEILING HEIGHT
2.3M

(FLAT BULD)
REQUIRED ASSEMBLY SPACE

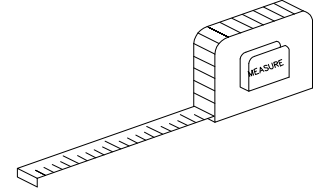
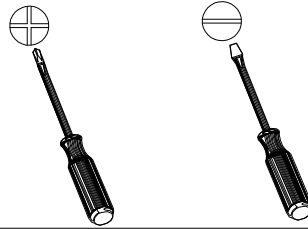

REQUIRED ASSEMBLY TOOLS

ASSEMBLED DIMENSIONS

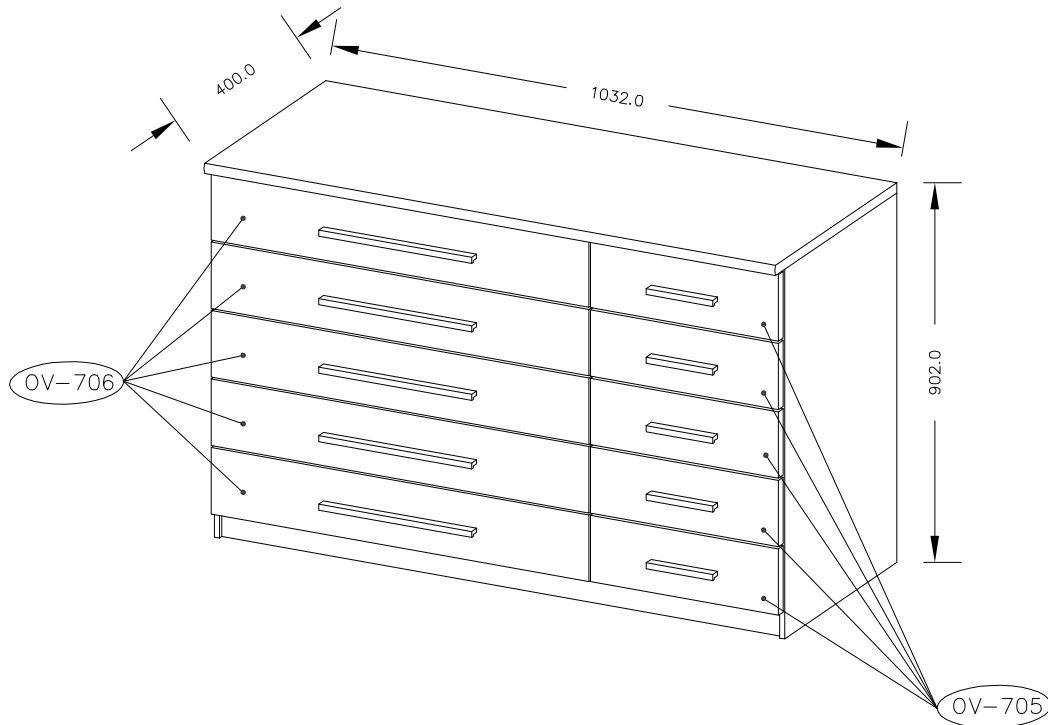

NO.	PART LIST	QTY
120	LEFT SIDE	1
121	RIGHT SIDE	1
205	DASH PANEL	1
422	UPPER WREATH	1
423	BOTTOM WREATH	1
806	BATTEN OF PLINTH	2
375	JOINING SLAT	1
376	JOINING SLAT	1
706	LEFT DRAWER'S FRONT	5
705	RIGHT DRAWER'S FRONT	5
910	LEFT SIDE OF CARCASE	10
911	RIGHT SIDE OF CARCASE	10
962	WIDE BACK PANEL OF CARCASE	5
963	NARROW BACK PANEL OF CARCASE	5
052	WIDE BOTTOM OF DRAWER	5
053	NARROW BOTTOM OF DRAWER	5
004	BACK PANEL COMBINED WITH TAPE	1
005	BACK PANEL	1

PARTS LIST

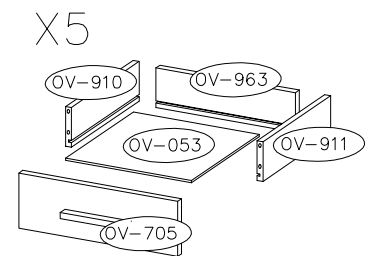
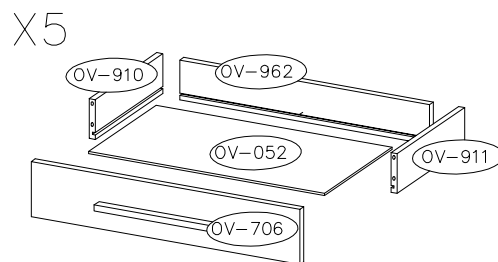
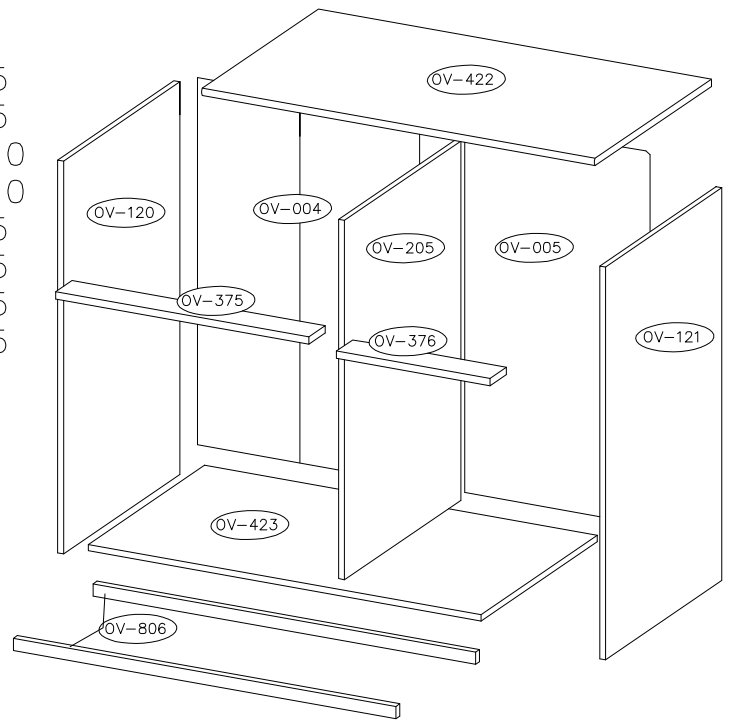









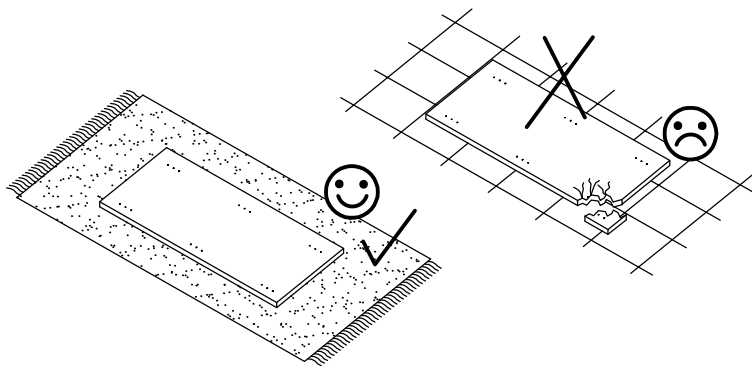
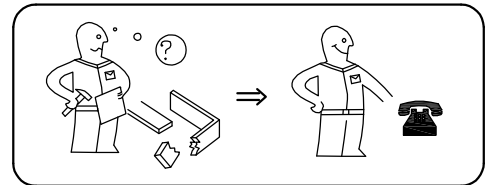
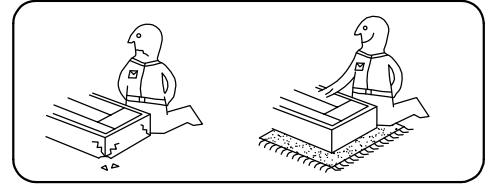
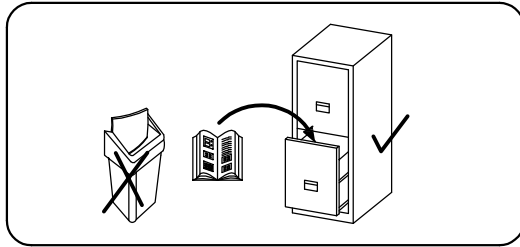

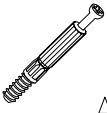



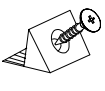
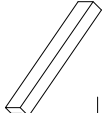

PACK 1 CONSISTS OF PARTS:

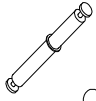
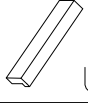
375, 376, 422, 423, 705, 706, 962, 963, 806, Al, Fittlings

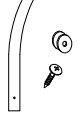
PACK 2 CONSISTS OF PARTS:

120, 121, 004, 005, 052, 053, 205, 910, 911

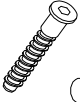

 A	 B	 D	6.3X13  F	M4.0X20  G	 I	 J	 U	 N	3.5X13  S
14	16	63	40	20	3	10	5	4	16
 Q	 U1	3mm  K1	 L1	 J2	3.0X10  M1	3.0X15  P1	5.0X50  Q1	 R	
1	5	1	1	5	10	60	40	 L	
								10 KPL	

Top Tips before you start!

1. Please check that all parts are present before you start the assembly of your furniture, as once assembled, the furniture is exempt from our home approval policy.
2. For ease and speed of assembly, we recommend that before you commence each step of the assembly, that you identify all the parts required for that step.
3. For larger items, please ensure that you have sufficient space and people (as indicated on page 1) to assemble your product safely.
4. We recommend that, where possible, all items are assembled near to the area in which they will be placed in use, to avoid moving the product unnecessarily once assembled.
5. For the protection of your furniture, particularly items of high gloss finish, we recommend that the product is placed on a protected surface during assembly to prevent any damage.
6. During assembly please take care not to over-tighten any fittings, as this may damage the product.

Care and Maintenance of your Furniture



Please periodically check all fittings and re-tighten as necessary.

To clean your item, please use a damp cloth and wipe clean.



Never allow any kind of liquid to remain on your furniture. Absorption can cause wood to warp or finishes to de-laminate.

Please do not place hot items (e. g. hot drinks) directly on to the wood surface.



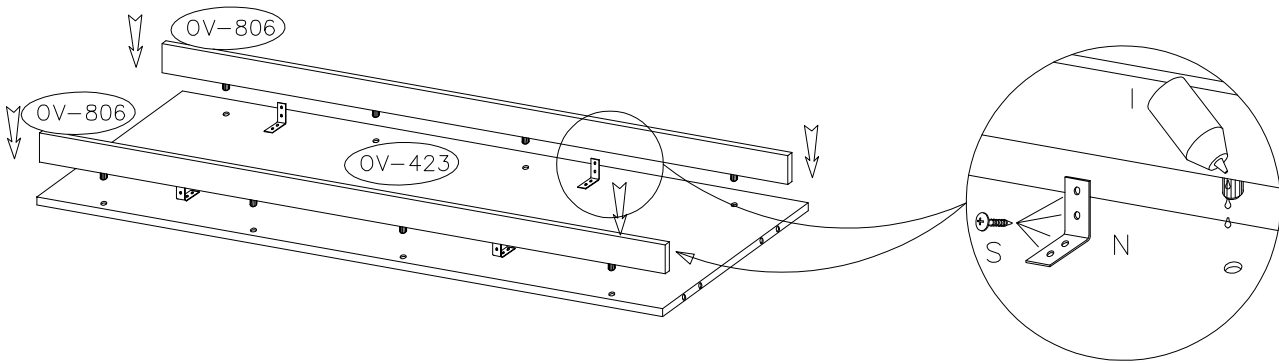
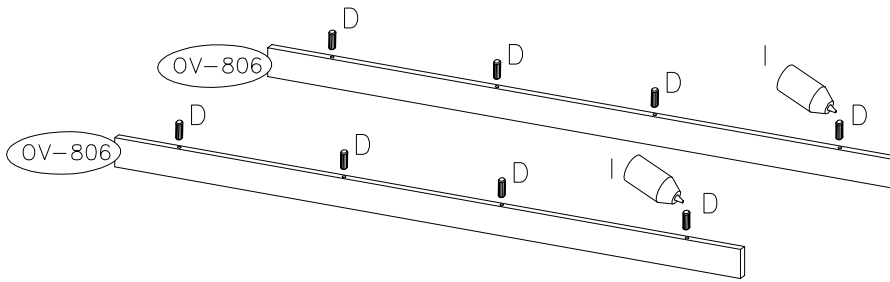
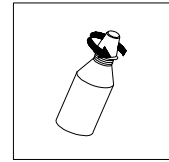

Please do not drag or pull your furniture.

			3.5X13
D	I	N	S
8	1	4	16

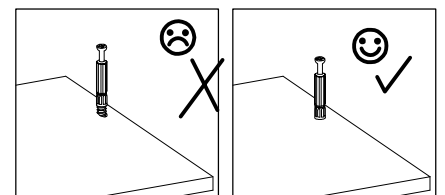
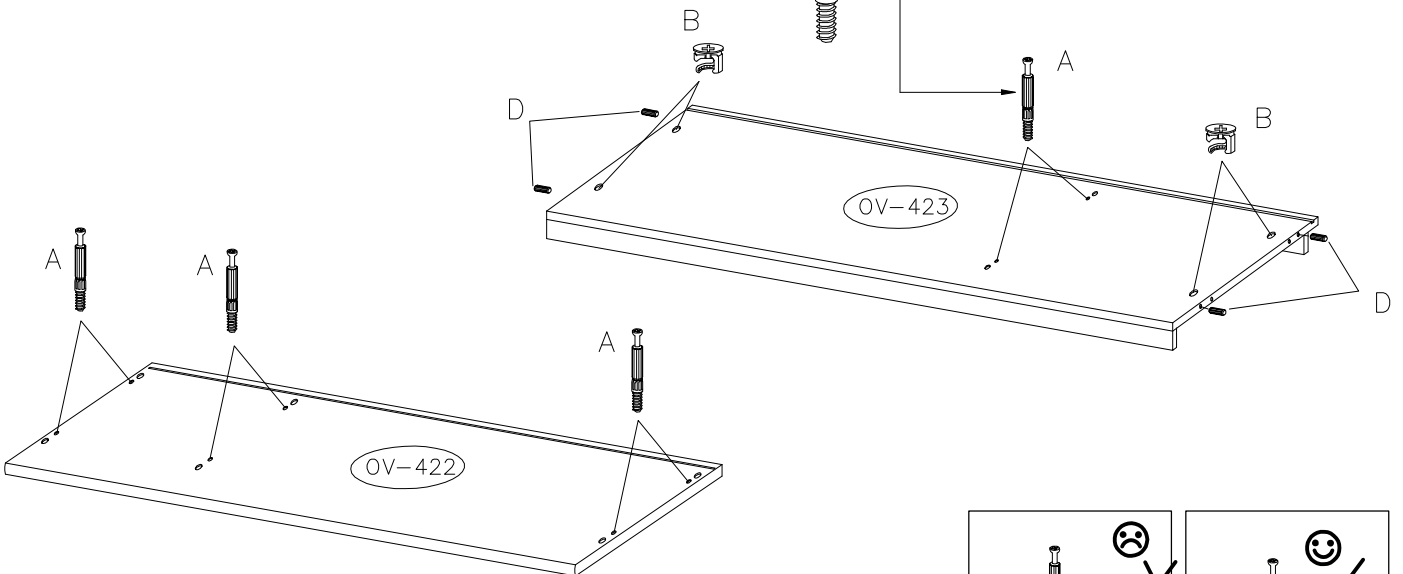
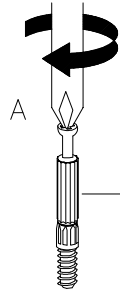



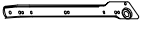
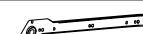

		
A	B	D
8	4	4

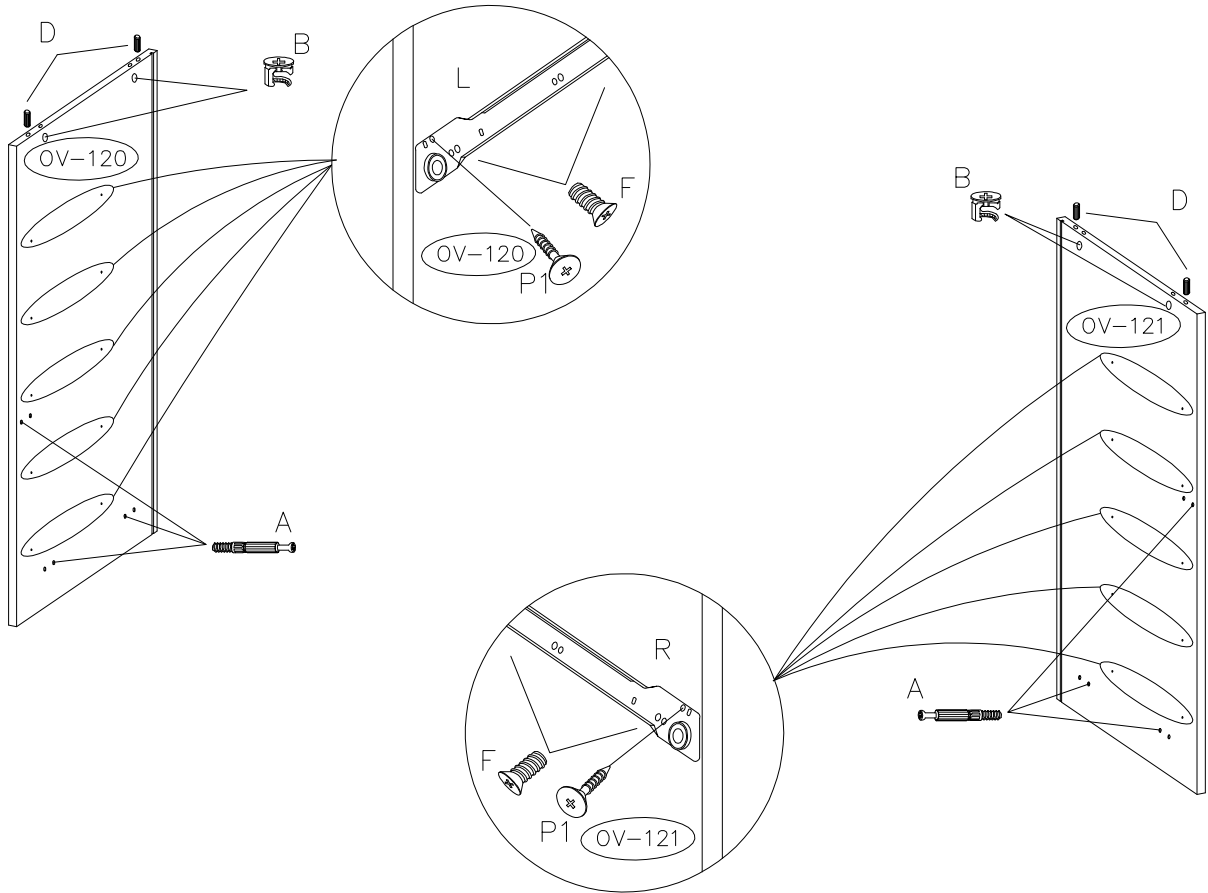





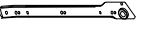

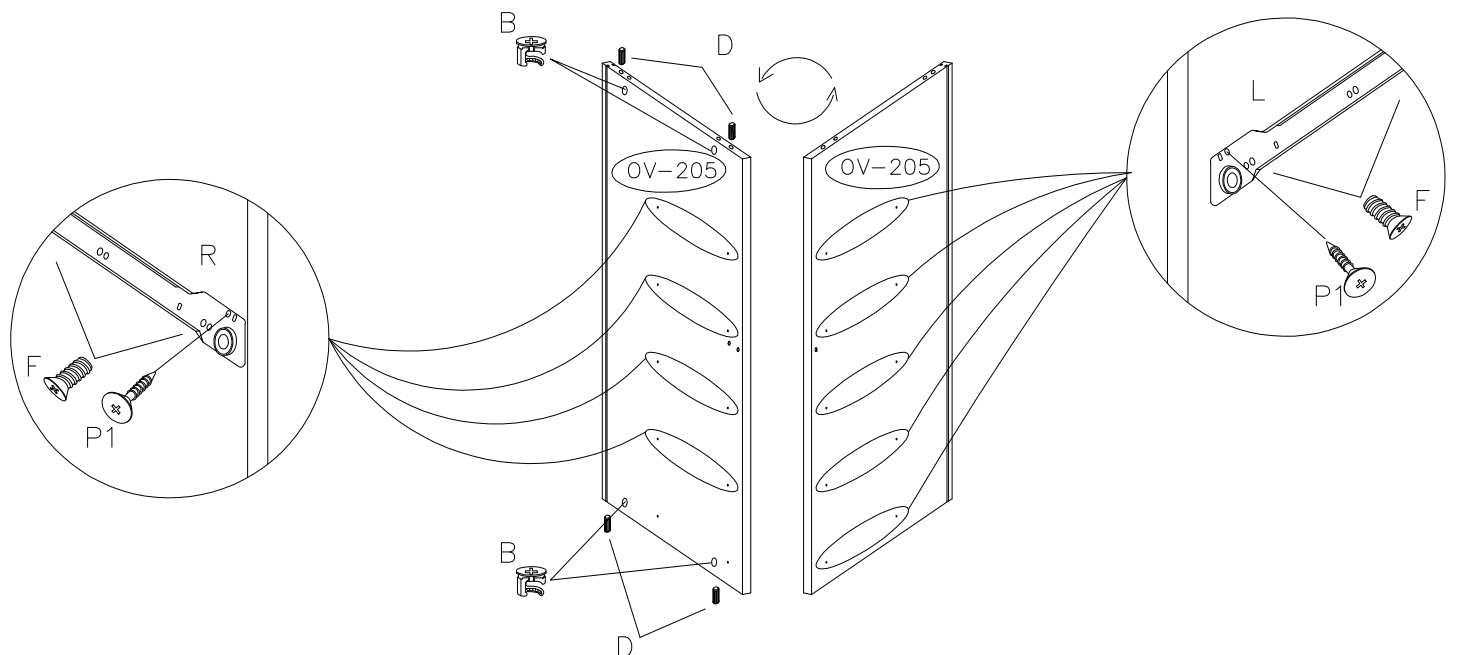
			6.3X13 	3.0X15 	 R  L
6	4	4	20	10	5 KPL

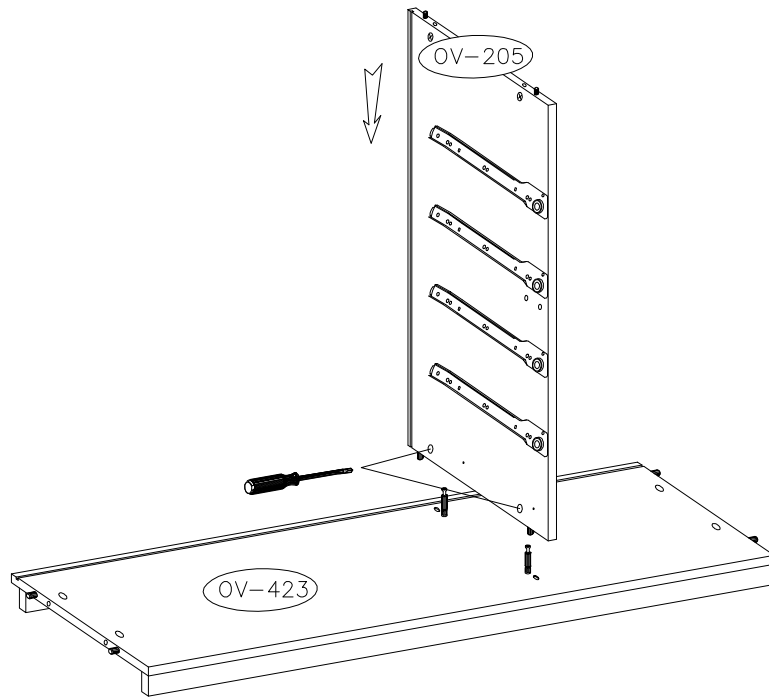



		6.3X13 	3.0X15 	 L	 R
4	4	18	9	5	4

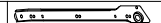



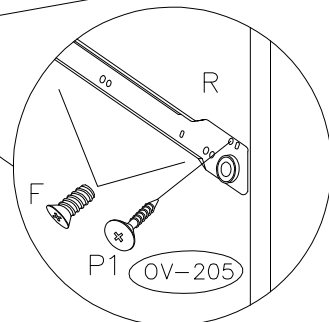
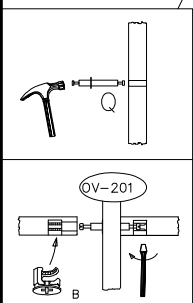
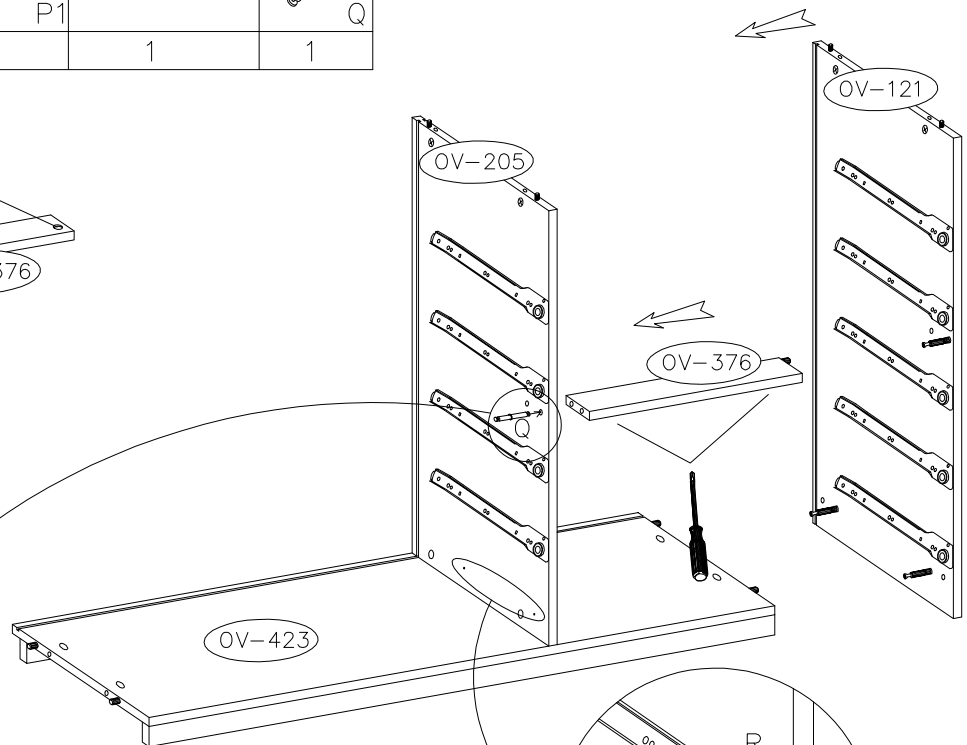
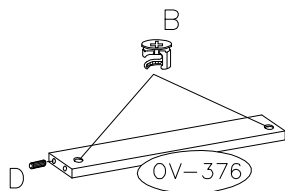





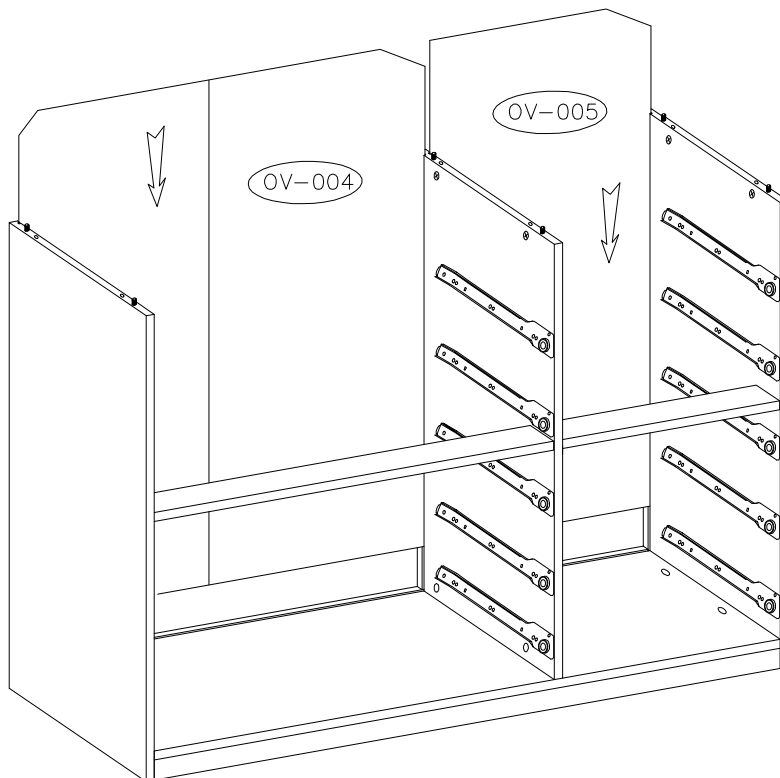
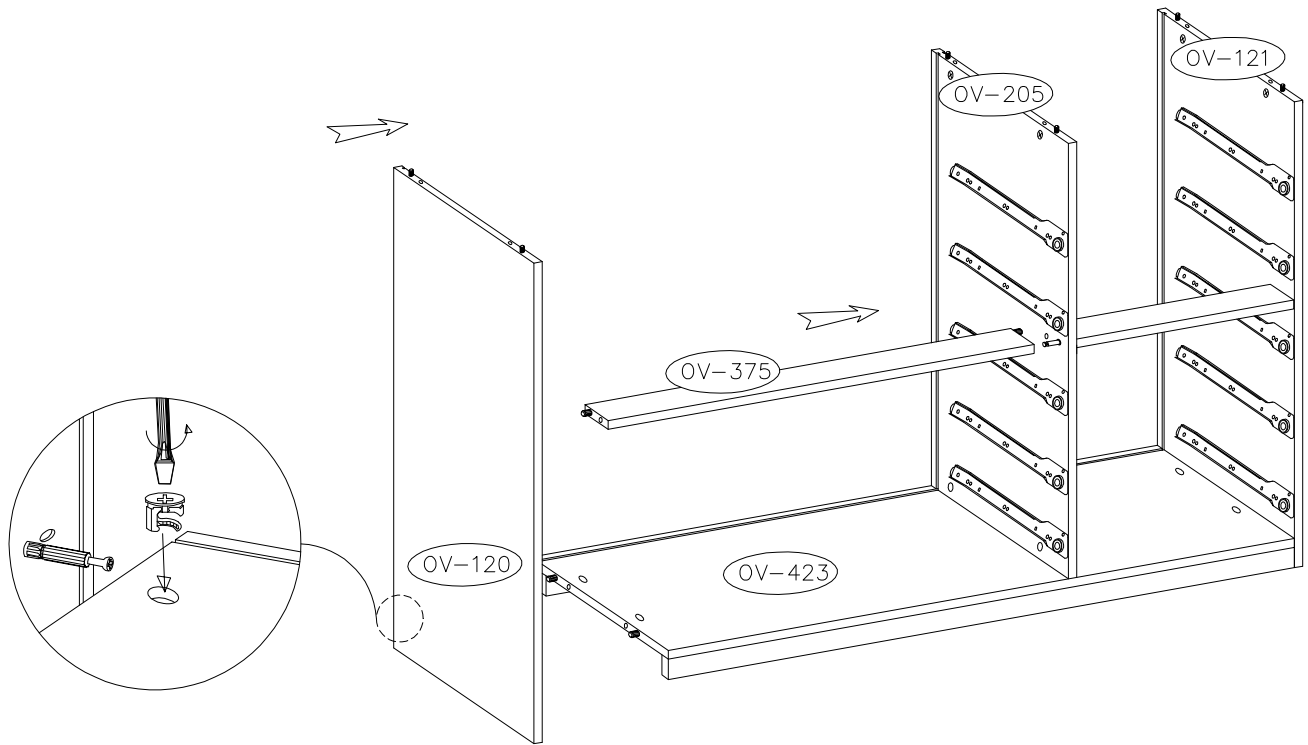
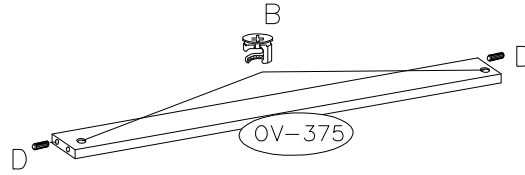

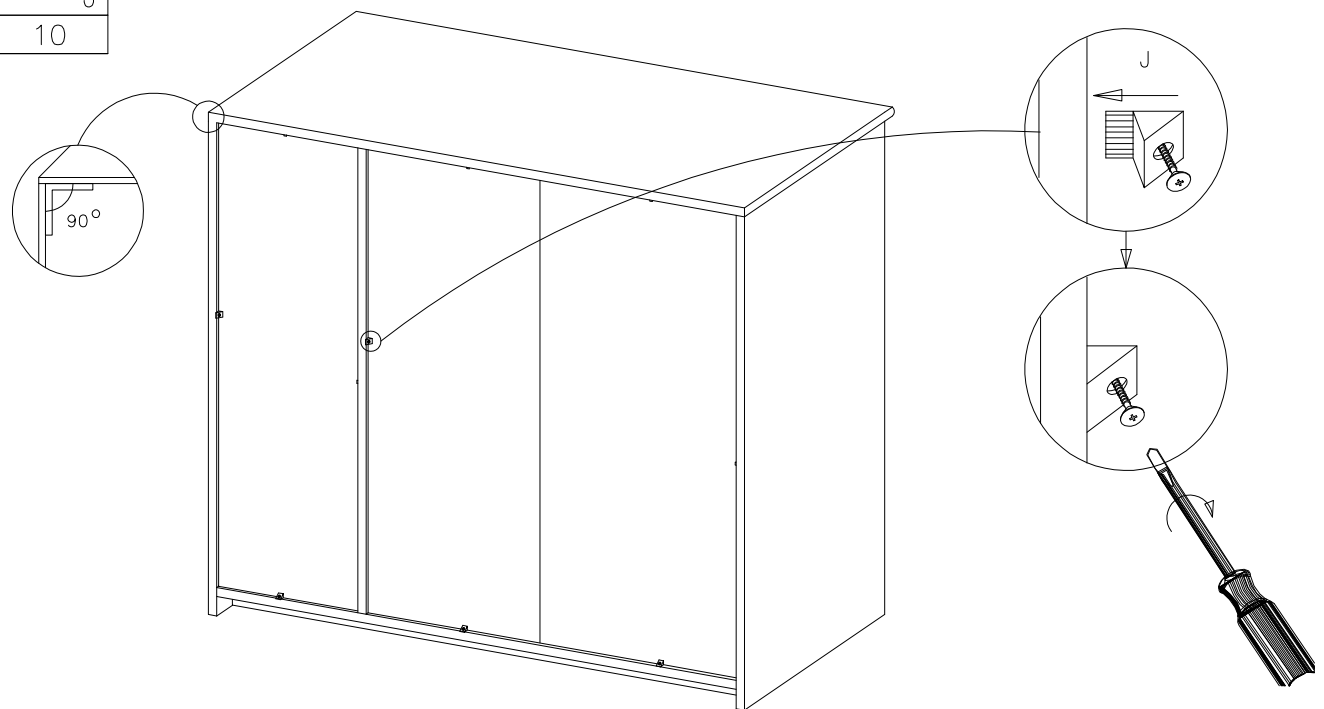
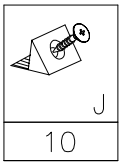
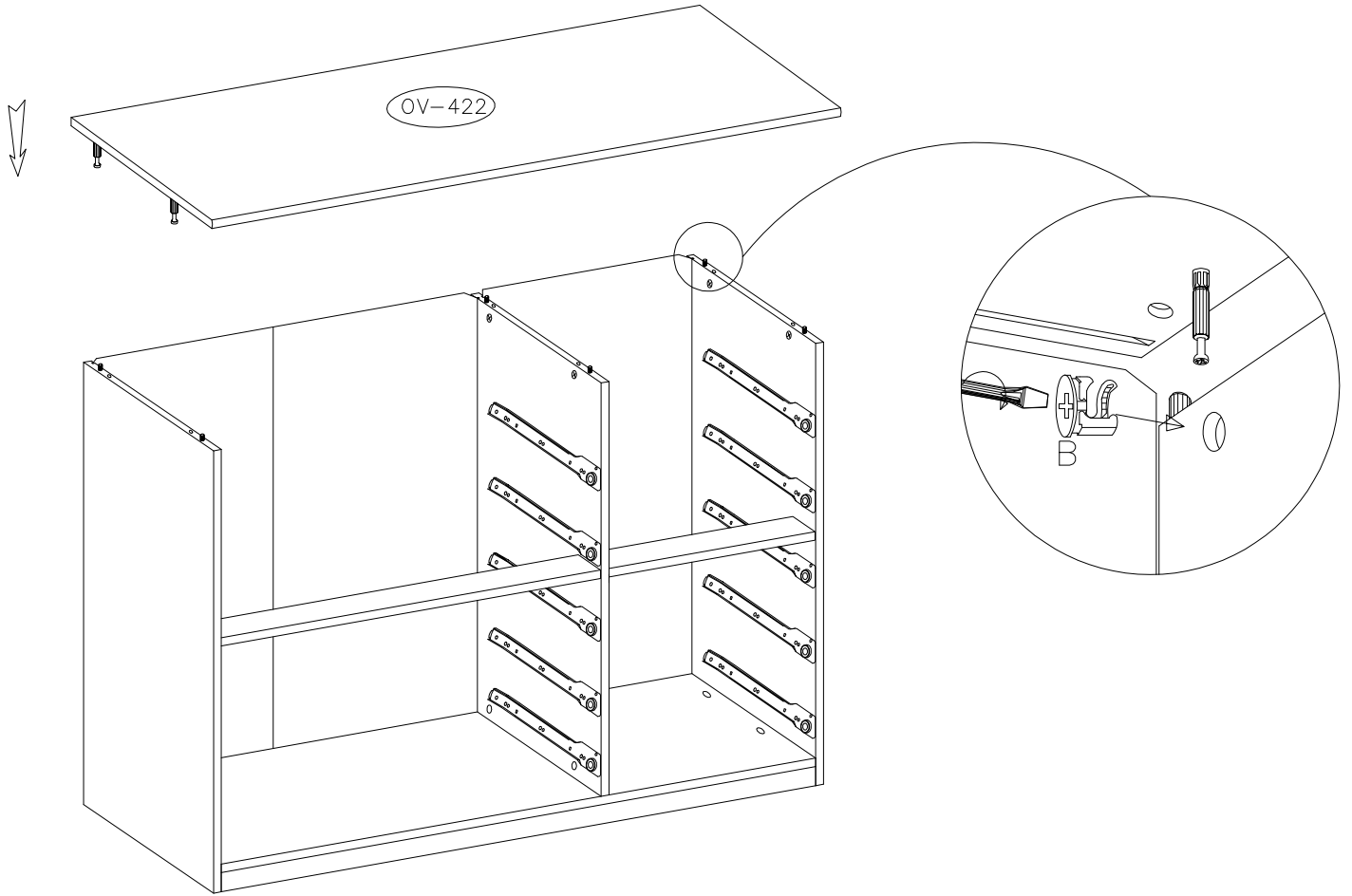



		6.3X13 	3.0X15 	 R	
2 B	1 D	2 F	1 P1	1 R	1 Q
2	1	2	1	1	1



	
B	
2	2





 D	 I	M4.0X20  G	 U	3mm  K1	3.0X15  P1	5.0X50  Q1	 R  L	 U1	 J2	3.0X10  M1
40	2	20	5	1	40	40	10 KPL	5	5	10

