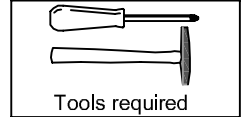

B740-A**Please read before assembling the product**

Carefully open packaging.

Check you have all the components shown on instructions sheets. Some products, instructions and fittings are packed in more than one box.

Handle Panels with care. Complete each stage before going to the next one.

Please keep packaging until assembly is complete. We hope that you are happy with the product.



Please recycle packaging



Keep fittings away from children



No power tools when inserting cam pins



No power tools when tightening cams

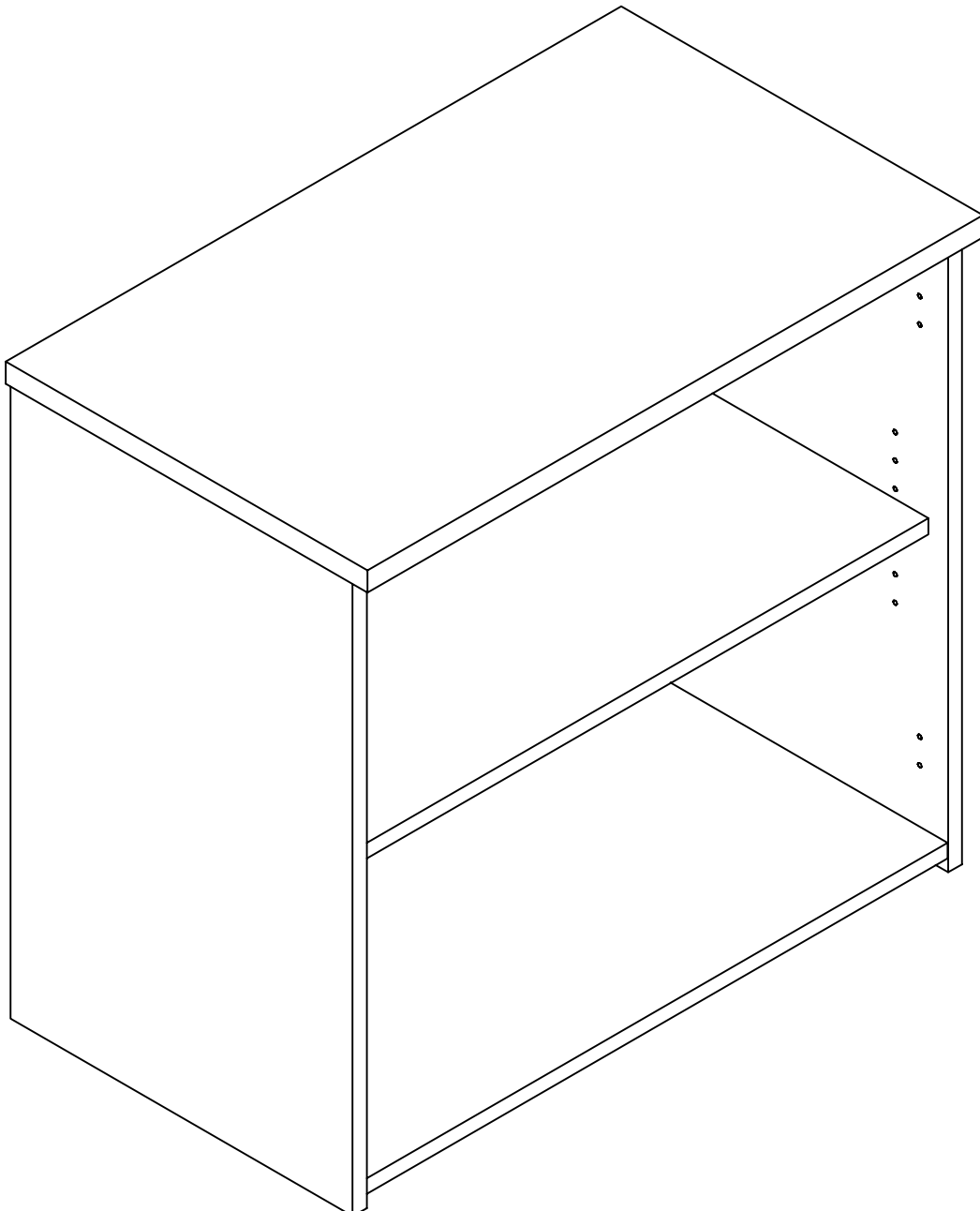









Please check that you have all the fittings

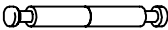

B740-A

4	Shelf clip PAR07		14	Wood dowel 5mm WOW1	
12	Quick fix pin PIN10		8	Graphite Grey Cover Caps CAP09	
16	Cam 15N CAM03		2	1½" x 8 screw SCR11	
2	Double Minifix Pin B34 PIN03				



Please check that you have all the panels



B740-A

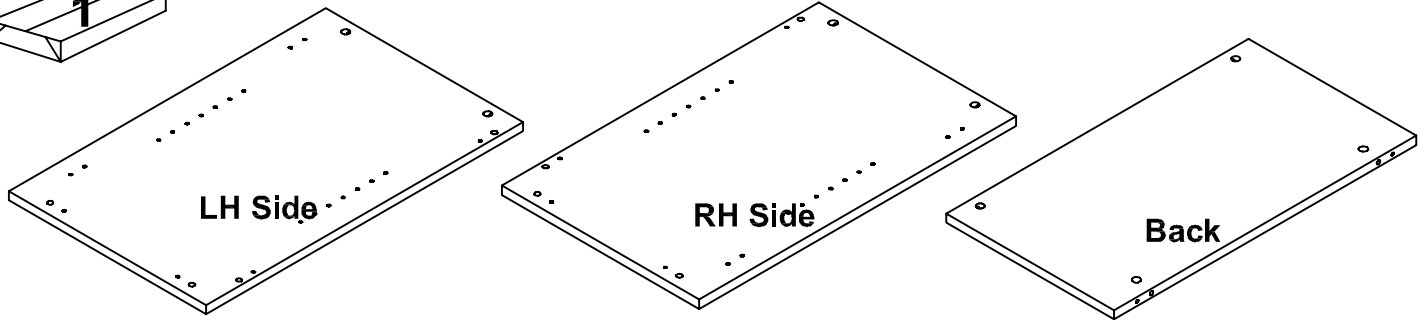
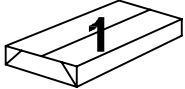

1	LH Side
1	RH Side
2	Back

TP

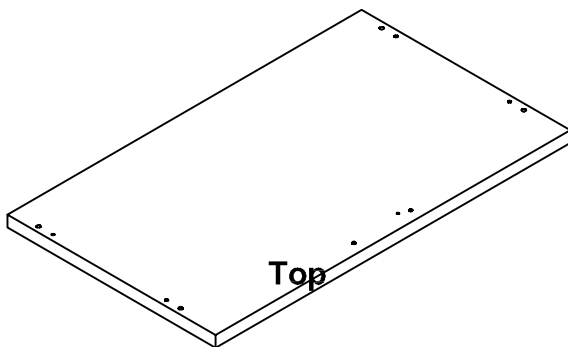

1	Top
----------	-----

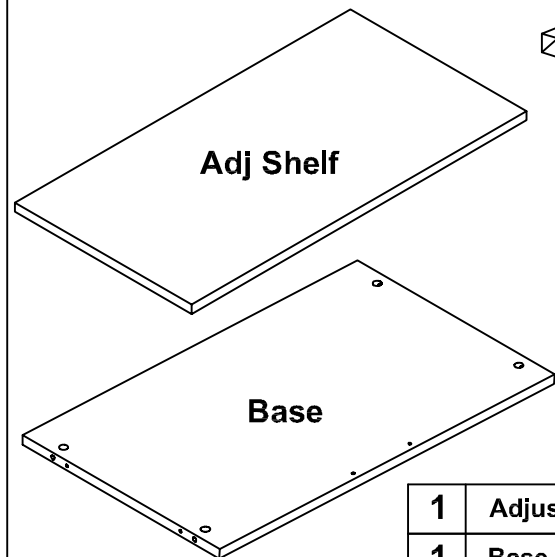
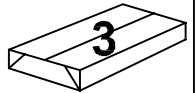

FBS



1	Adjustable Shelf
1	Base

1

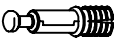
LH Side

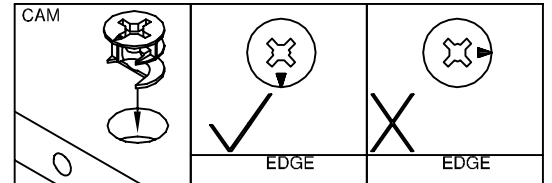
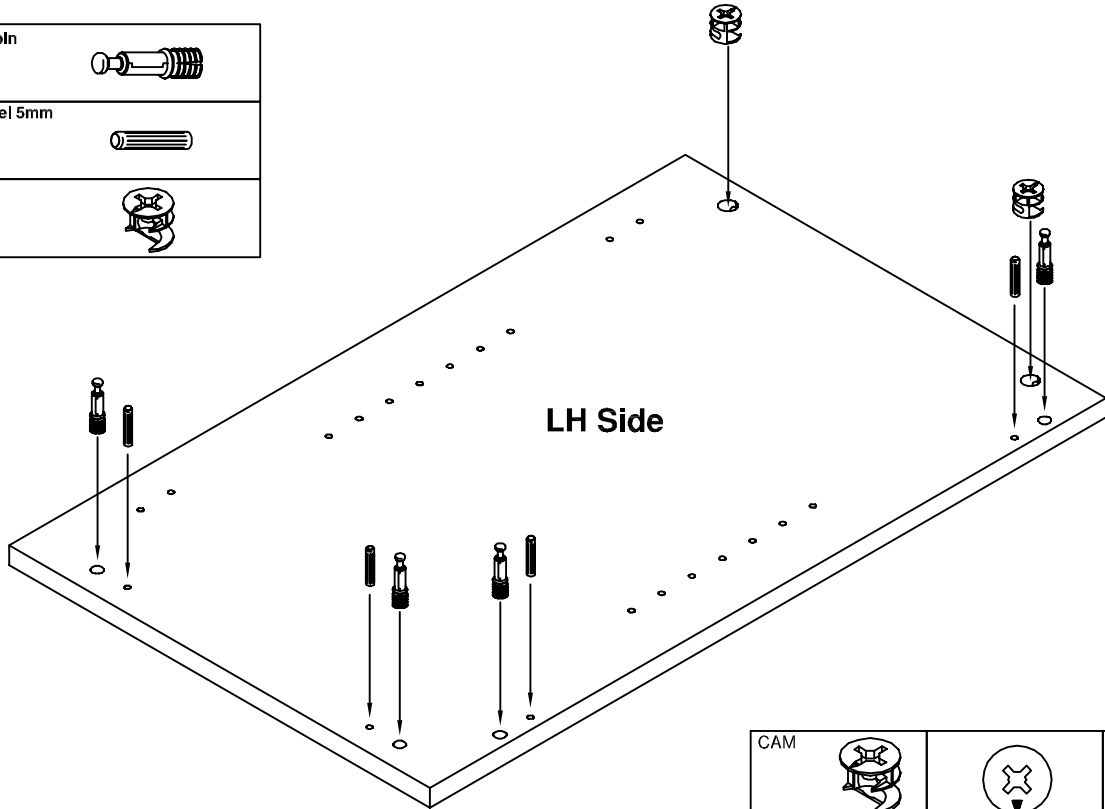

4	Quick fix pin PIN10	
4	Wood dowel 5mm WOW1	
2	Cam 15N CAM03	



Insert the cam into the 'surface' hole with the arrow aimed at the adjacent edge which has the smaller hole.

2

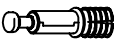
RH Side

4	Quick fix pin PIN10	
4	Wood dowel 5mm WOW1	
2	Cam 15N CAM03	

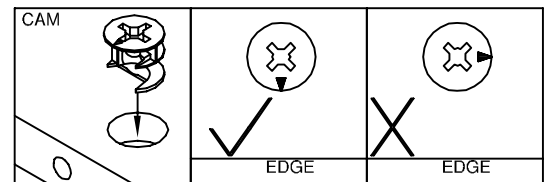
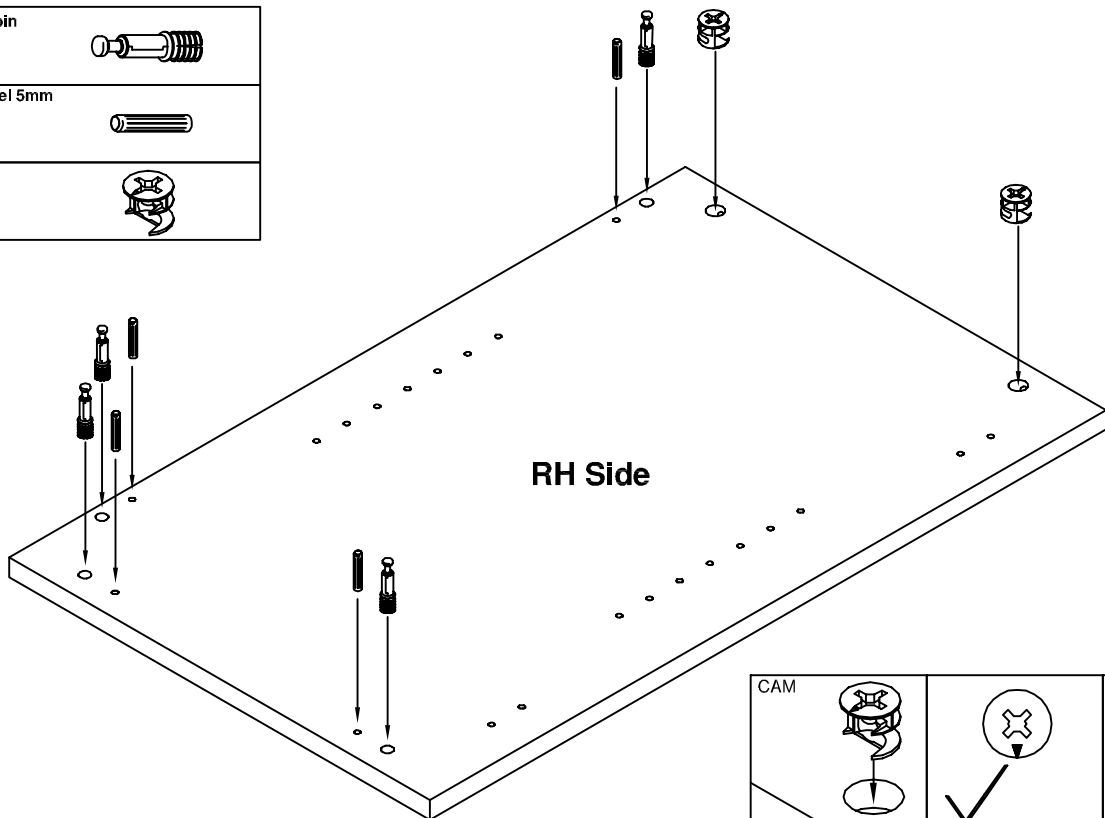

Insert the cam into the 'surface' hole with the arrow aimed at the adjacent edge which has the smaller hole.

3

Back x2

4 per back	Cam 15N CAM03	
----------------------	------------------	---

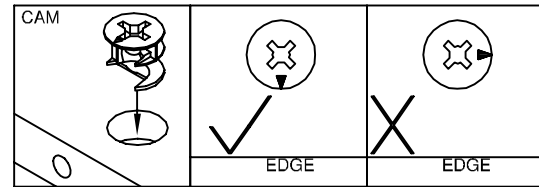
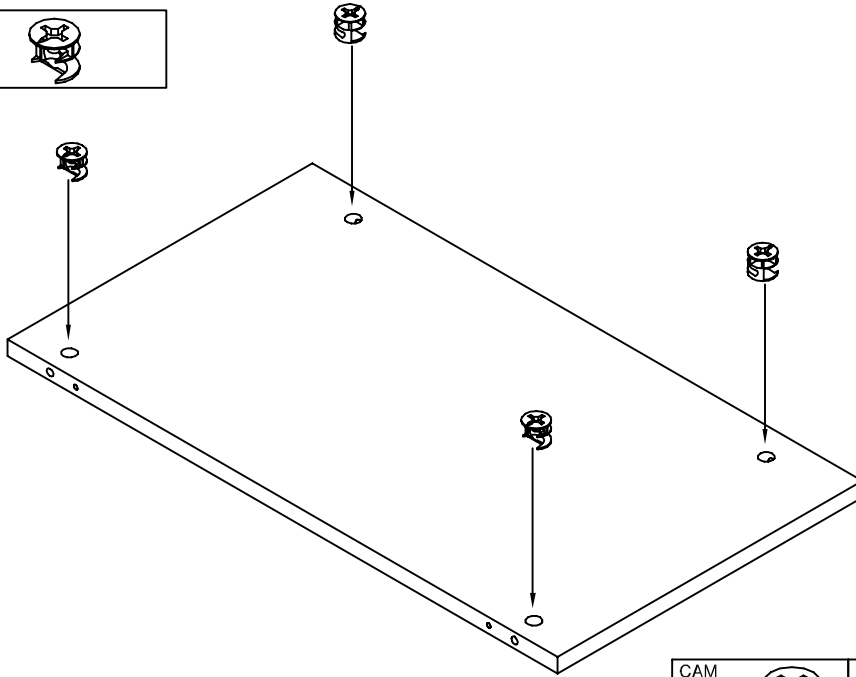

Insert the cam into the 'surface' hole with the arrow aimed at the adjacent edge which has the smaller hole.

4

Back x2

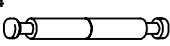
2	Wood dowel 5mm WOW1	
2	Double Minifix Pin B34 PIN03	

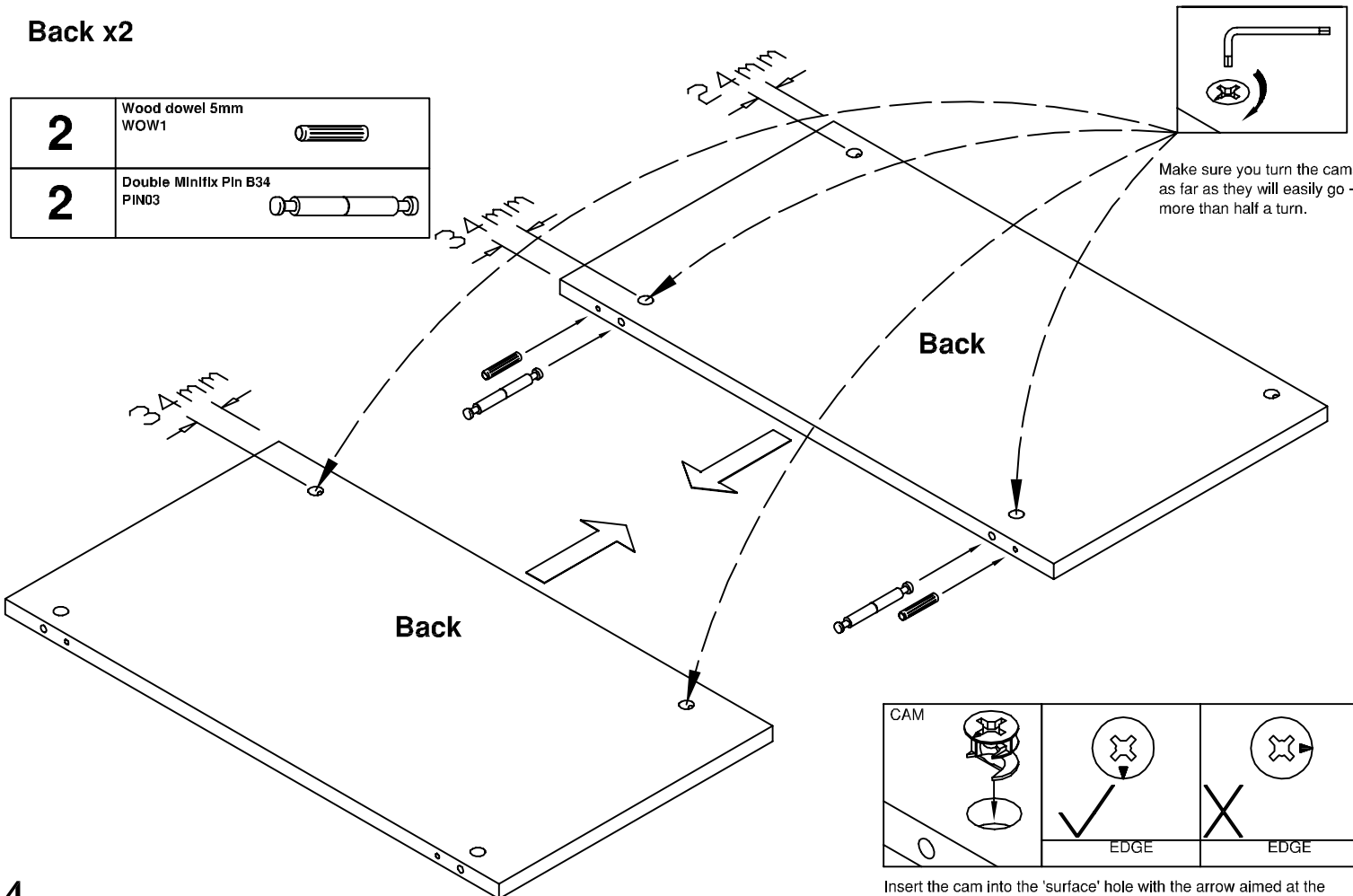

Make sure you turn the cams as far as they will easily go - more than half a turn.

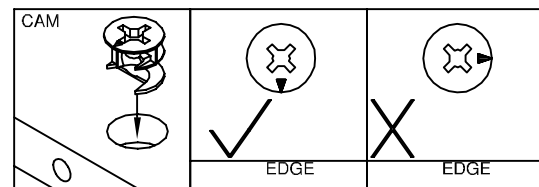

Insert the cam into the 'surface' hole with the arrow aimed at the adjacent edge which has the smaller hole.

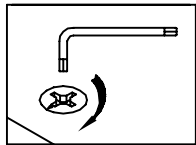

Make sure you turn the cams as far as they will easily go - more than half a turn.

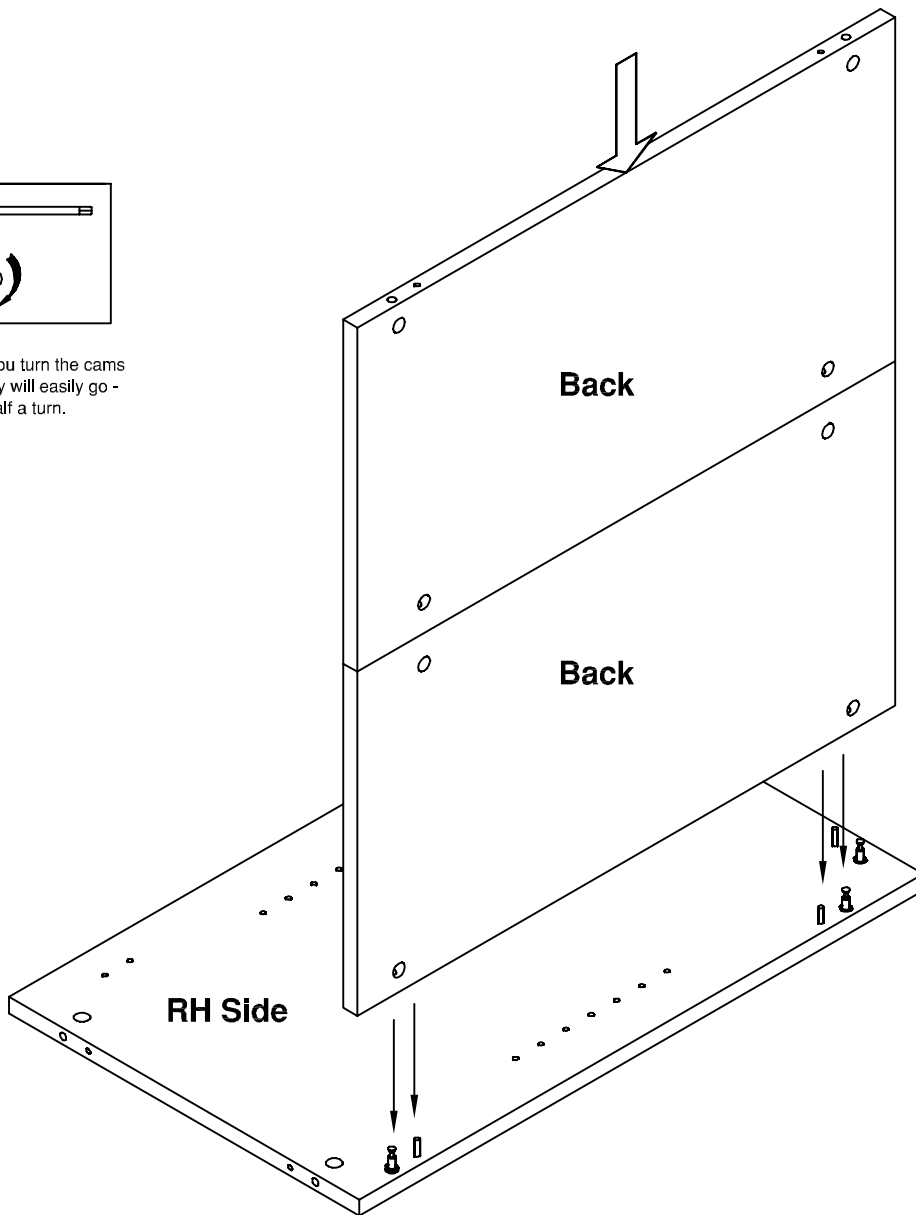

Base

4	Cam 15N CAM03	
----------	------------------	--

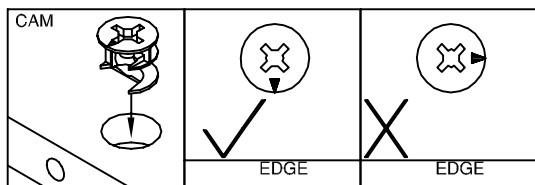

Insert the cam into the 'surface' hole with the arrow aimed at the adjacent edge which has the smaller hole.

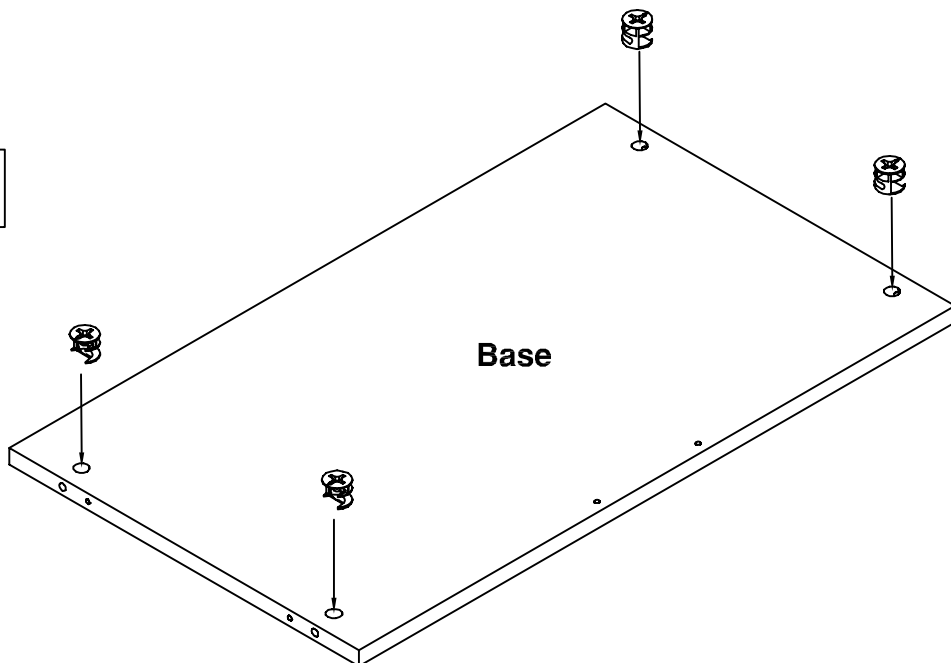

7

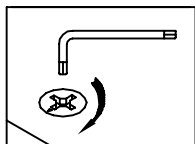

Make sure you turn the cams as far as they will easily go - more than half a turn.

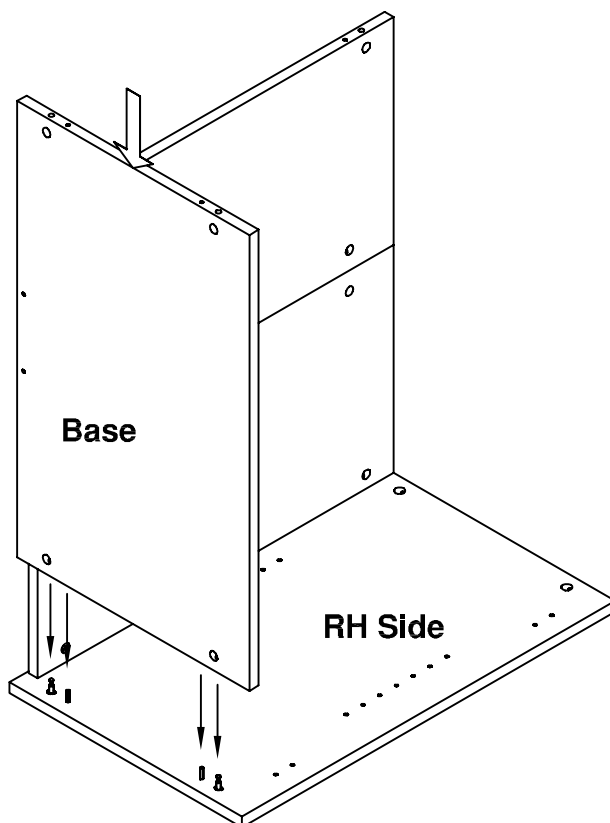

8

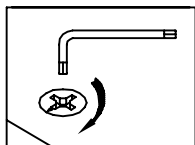

Make sure you turn the cams as far as they will easily go - more than half a turn.

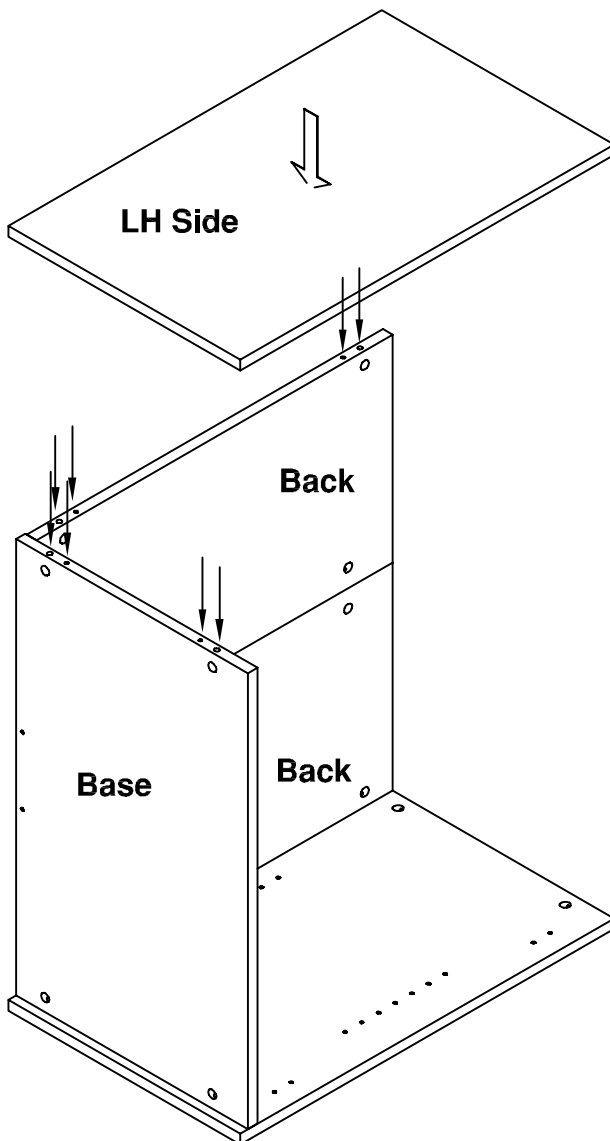

2

1½" x 8 screw
SCR11

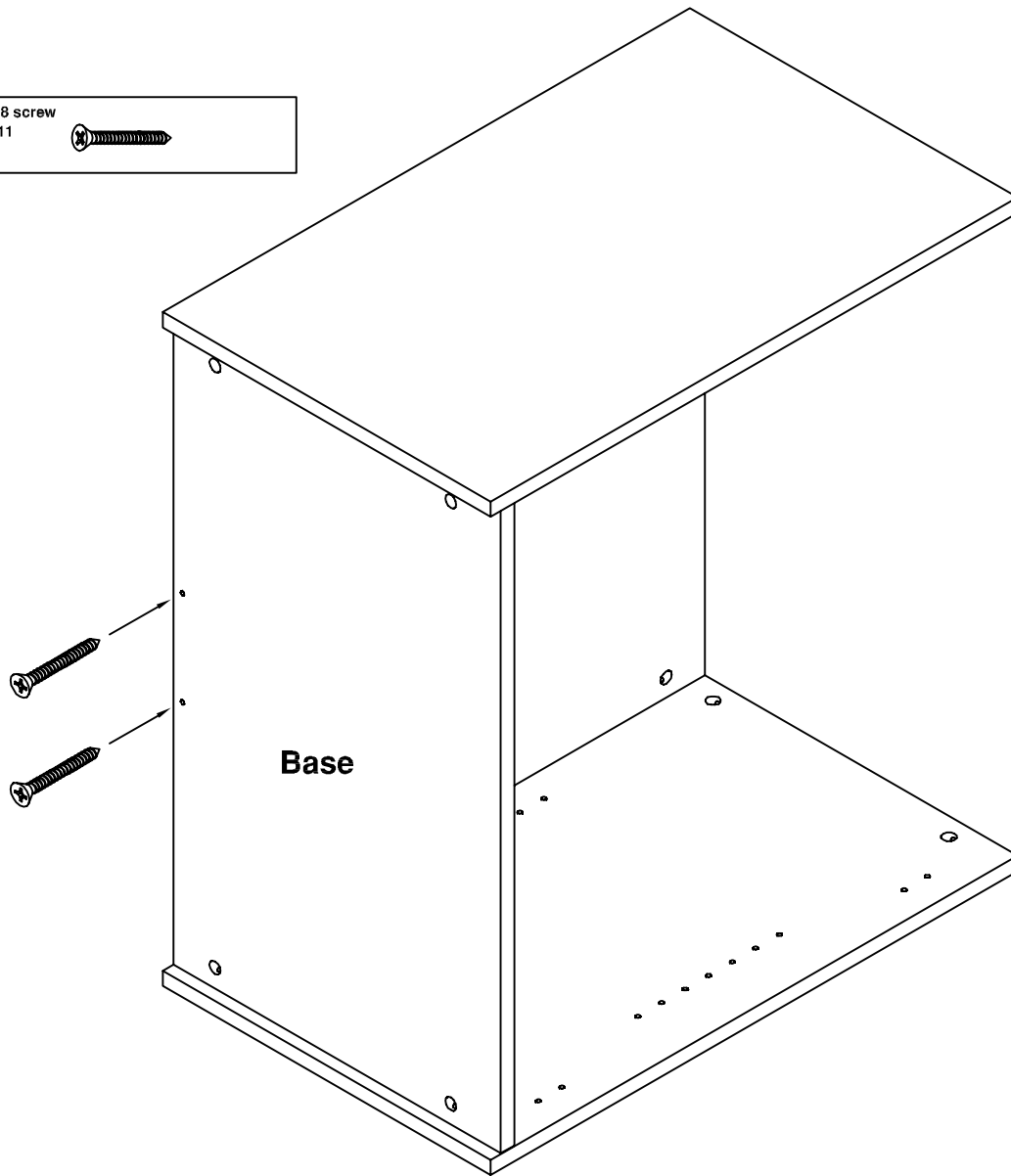

Base

4

Quick fix pin
PIN10



4

Wood dowel 5mm
WOW1

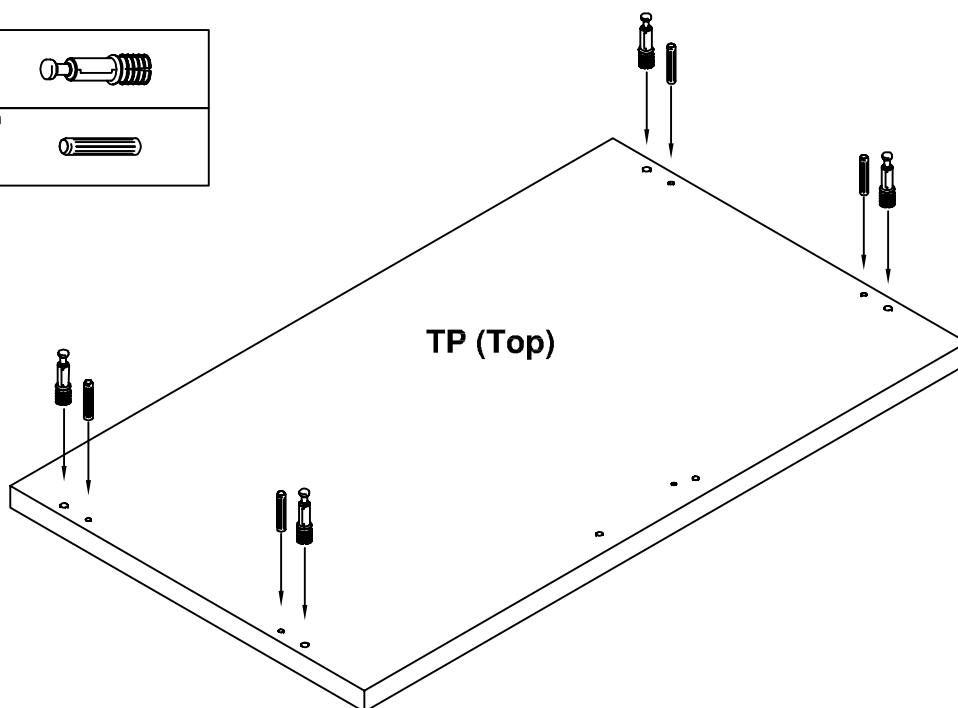

TP (Top)

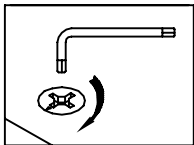

Make sure you turn the cams as far as they will easily go - more than half a turn.

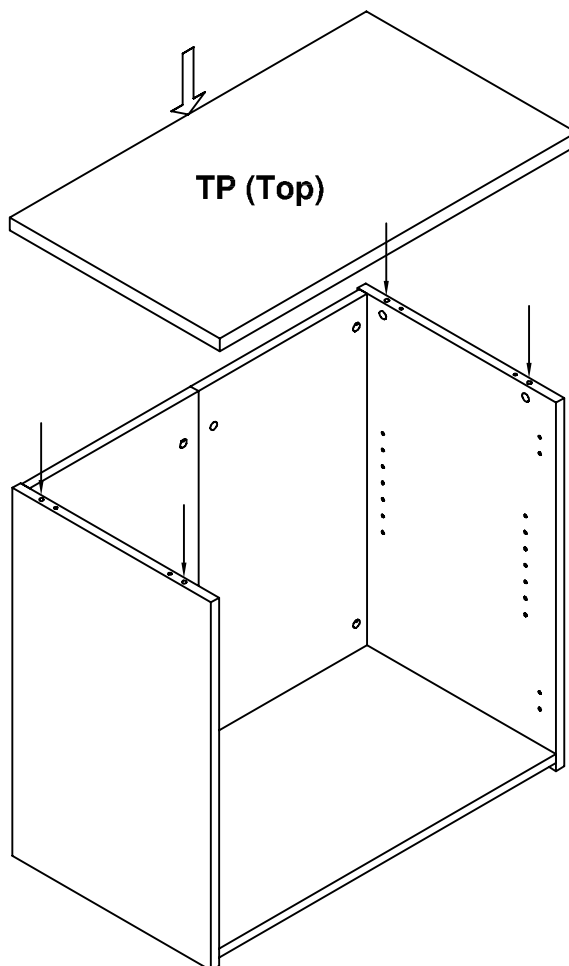

Please note:

The shelf can be positioned at various heights.

4

Shelf clip
PAR07

