



B3R
B3U



Endurance®

B3R RECUMBENT BIKE & B3U BIKE

User Manual

B3U/B3R

SAFETY TIPS.....	1
MOVING.....	3
LEVELING.....	4
SEAT ADJUSTMENTS.....	5
CONTROL PANEL AND WINDOW DISPLAYS	6
WINDOW DISPLAYS.....	7
CONTROL PANEL FUNCTIONS	9
QUICK REFERENCE OPERATING INSTRUCTIONS.....	10
MANUAL WORKOUT.....	12
PRE-PROGRAM WORKOUT.....	14
RANDOM WORKOUT.....	16
USING THE HEART RATE CONTROL.....	18
TRANSMITTER STRAP PLACEMENT.....	19
HEART RATE CONTROL.....	20
CRUISE CONTROL.....	22
TARGET HEART RATE ZONE.....	23
BENEFITS.....	24
LIMITED HOME USE WARRANTY.....	25
LIMITED LIGHT COMMERCIAL WARRANTY	26
DEVELOPING A FITNESS PROGRAM.....	29
NOTES	30
FLEXIBILITY.....	31
EXERCISE GUIDELINES.....	35
ACHIEVING YOUR FITNESS GOALS	36
SAMPLE GOALS.....	37
Diary.....	38



SAFETY TIPS

IMPORTANT SAFETY INSTRUCTIONS SAVE THESE INSTRUCTIONS

When using an electrical product, basic precautions should always be followed, including the following:

Read all instructions before using this exercise product.

Your ENDURANCE BIKE is self-generating (requiring no external power source) and in this mode must be pedaled to power-up the console.

Alternatively, the BIKE can instead be plugged into an outlet using the included power supply.

WARNING!

To reduce the risk of burns, fire, electrical shock or injury to persons:

- Use this exercise product for its intended use as described in this Owner's Guide. Do not use attachments not recommended by the manufacturer.
- Never drop or insert any object into any opening.
- Do not remove the BIKE side covers. Only an authorized ENDURANCE retailer should perform service.
- Never operate this BIKE if it has a damaged cord or plug, if it is not working properly, if it has been damaged, or immersed in water. Return the RECUMBENT BIKE to a retailer for examination and repair.
- Do not use outdoors.

CHILDREN

- Keep children off your ENDURANCE BIKE at all times.
- When the ENDURANCE BIKE is in use, young children and pets should be kept at least 10 feet away.

The logo for Endurance is a stylized, elongated oval shape with a white outline and a light gray fill. Inside the oval, the word "ENDURANCE" is written in a white, sans-serif font. The letter "E" at the end of the word has a registered trademark symbol (®) next to it. The number "1" is centered below the word.

ENDURANCE®

SAFETY TIPS

OTHER SAFETY TIPS FOR YOUR ENDURANCE BIKE

CAUTION!

If you experience chest pains, nausea, dizziness or shortness of breath, stop exercising immediately and consult your physician before continuing.

- Do not wear clothing that might catch on any part of the BIKE.
- Read this Owner's Guide before operating this BIKE.

CLEANING

- Clean with soap and slightly damp cloth only; never use solvents.



MOVING

Your ENDURANCE product has a pair of transport wheels built into the front legs.

To move the ENDURANCE upright cycle, firmly grasp the handlebars, carefully tip toward you and roll on the transport wheels.

To move the ENDURANCE recumbent bike and elliptical, firmly grasp the rear foot assembly, carefully lift and roll on the transport wheels.

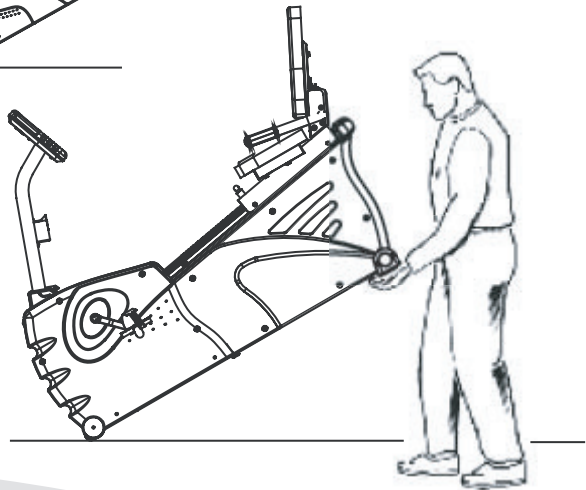
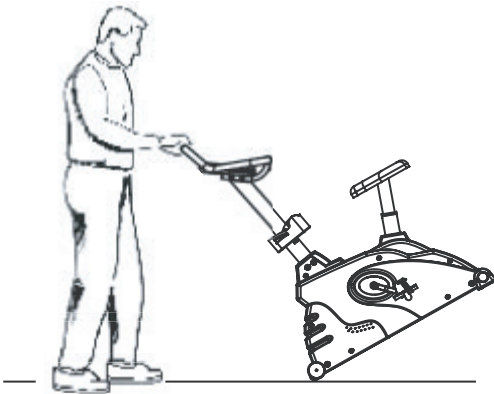

Caution: Our product is wellbuilt and heavy.
Take caution and use additional help if necessary.

R A N C E[®]

LEVELING

The RECUMBENT BIKE should be level for optimum use. If your RECUMBENT BIKE wobbles when you have placed it where you intend to use it, raise or lower one or both of the adjustable levelers located on the bottom of the rear foot support. Once you have leveled the RECUMBENT BIKE, lock the levelers in place by tightening the wing nuts against the rear foot support.

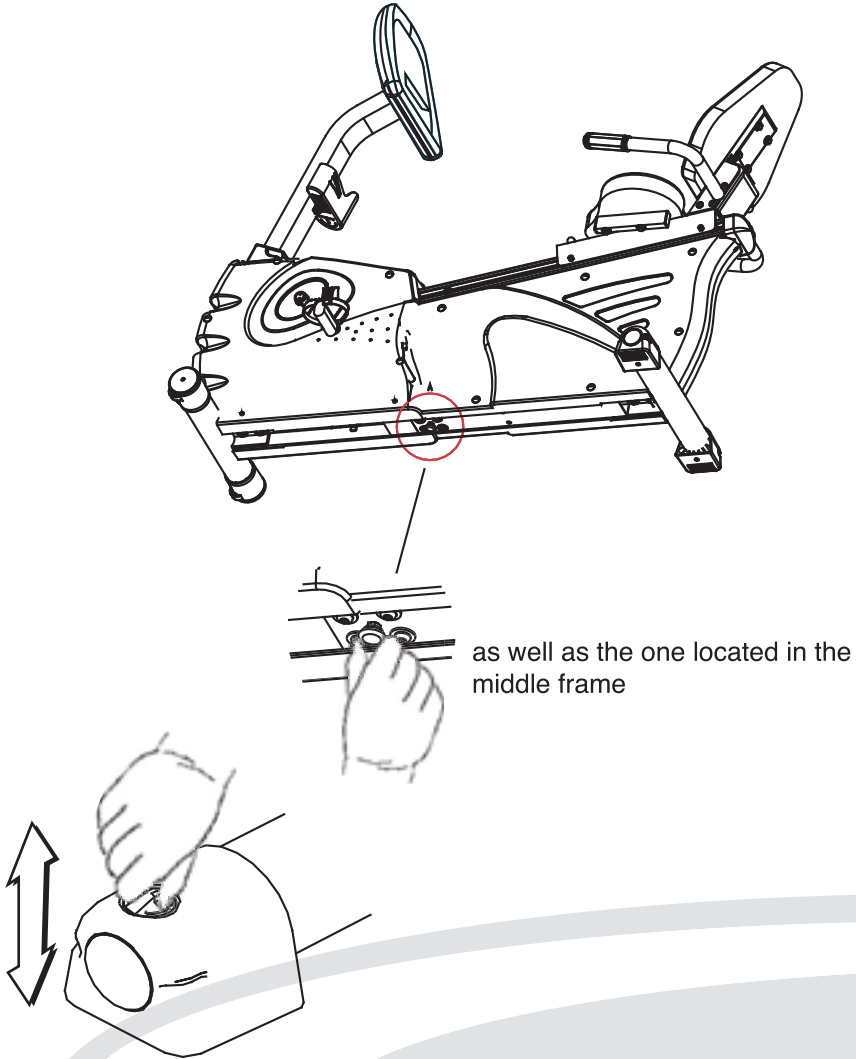

ENDU

SEAT ADJUSTMENTS

SEAT POSITIONING

The seat is at the proper position when your knee is slightly bent when the pedal is in the furthest position, with the ball of your foot centered on the pedal.

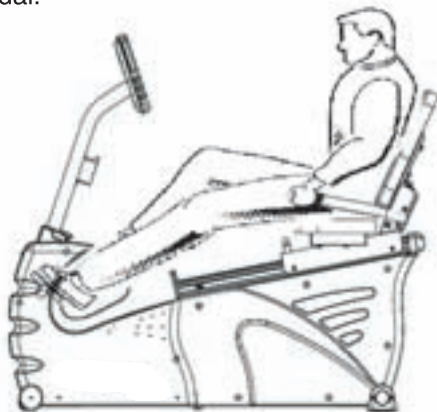

SEAT POSITION

Grasp the Seat Adjustment Knob, located at the base of the seat post. Pull out then raise or lower the seat post to the desired height. Release the knob and allow the seat post to lock into position.



While seated on the RECUMBENT BIKE, lift the Seat Lever and slide the seat forward or back. When the seat is positioned properly, simply release the Seat Lever to lock the seat into its proper position.

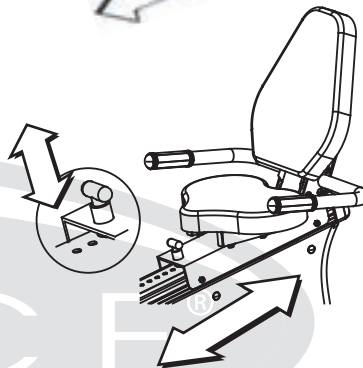

R A N C E

CONTROL PANEL AND WINDOW DISPLAYS



WINDOW DISPLAYS

Time:

Indicates elapsed time after pressing start (0-99 minutes and 59 seconds). Can also be set to count down.

Work Level:

Indicates what level you are working at, from level 1 to level 16.

Distance:

Indicates miles traveled in .01 mile increments up to 99.9 .

Watts:

A measurement of your expended energy. May be used to evaluate and quantify your fitness progress over time. The B3U/B3R watts range from 30-275 watts.

RPM:

Shown as revolutions per minute. Improve cycling technique while reducing leg muscle fatigue by pedaling between 80 & 100 RPMs.

METS:

One MET is the amount of energy your body uses at rest. If a physical activity has an equivalent of six METS, its energy demands are six times that of your resting state.

Heart Rate:

Shown as beats per minute. You can monitor your heart rate at any time during a workout.

Calories:

Indicates estimated accumulated calories burned, based on weight, distance, workload and time.

NOTE:

This information will only display as long as you continue pedaling.

RANCO®

CONTROL PANEL FUNCTIONS

KEYS



Toggles readouts in message center from primary to secondary. Also allows message center to scan or rollover between the two if pressed and held. This is done only during run mode (after start has been pressed)



Begins workout. Moves user from set up to run.



Used to set variables during set up. Change work level/watts weight/time/age during run mode.



Enter variables.



10-key pad-1-0 Adjust variables during set up. Adjust level/watts/weight/time/age workload during run mode.



Reset by holding the reset button down for 3 seconds.

PROGRAM KEYS:

Used in set up to get user directly to desired workout. Each key includes an LED to let user know which workout they are in or have selected. Enables user to change programs during workout.



Shift Display:



FINISHING

When your workout is complete the display windows will begin flashing your workout information, allowing you to record it in your personal logbook.

NOTE:

This information will only display as long as you continue pedaling.



RANCO®

QUICK REFERENCE OPERATING INSTRUCTIONS

WITH EXPRESS COMMAND KEYS

The following is a quick overview of the basic operating features of your product. While more detailed operating instructions are on the following pages, these quick references will familiarize you with the basic operating procedures you need to get started.

QUICK START: (Manual Workout Only)

Press  Adjust workload using   keys

PROGRAMS:

Set your weight using   keys

Press 

Press 

For additional random profiles (RANDOM KEY)

Set program level using   key (pre-programs only)

Press 

Set time using   keys (15:00-99:00) or number key

Press 



ENDU

QUICK REFERENCE OPERATING INSTRUCTIONS

HEART RATE CONTROL:

Press  Press 

1.Set HR

Edit HR using   Press 

2.Set AGE

Edit using   Press 

3.Press



CRUISE CONTROL:

Enter workout while wearing heart rate transmitter or holding contacts.
(Heart rate will display in heart rate window.)
when you reach desired heart rate, press (HEART RATE CONTROL)
Cruise Control

RANCO®

MANUAL WORKOUT

There are two ways to use the machine in manual mode:

1) TO START

Begin pedaling (computer starts up at 25 RPMs) Message center reads

SET LEVEL

Press 

Message center reads

SET WEIGHT 150 (150 is default weight value)

Press 

NOTE: Time default to 30:00



User adjusts workload while in workout

2) "LONG VERSION"

Begin pedaling (computer starts up at 25 RPMs)

Message center reads:

SET WEIGHT 150 (150 is default weight value)

Use either the   key or the 10-key pad to set weight
Message reads:

PRESS ENTER

Press 

Message reads:

SET TIME 30:00

Use either the   key or 10-key pad to set time
(15:00-99:00)

Message reads:

PRESS START  or select function

Press



ENDU

MANUAL WORKOUT

NOTE:

User can move to any other workout by pressing the desired workout key. The workout will resume at a level compatible to the level the user was in. See earlier instructions for entering heart rate workout.

NOTE:

The time will count down to 00:03 and beep at each second until 00:00, then the timer will count up.

NOTE:

Information is held for 30 seconds if pedaling stops. After 30 seconds of inactivity, all information resets to "0"

NOTE:

While selecting work level for workouts, level is displayed in its window along with corresponding wattage.

NOTE:

Adjustment to work load in manual mode is done by wattage not work level. User makes adjustment by pressing



Adjustments are made in 10-watt increments. If key is held for 5 seconds scrolling of wattage runs faster.

NOTE:



User may go into any other workout by pressing the workout key they want to use. The only exception is heart rate control/cruise control where the user must either be wearing a Polar transmitter or holding a hand contact pad.

RANCOE®

PRE-PROGRAM WORKOUT

Begin pedaling
Message reads:

SET WEIGHT

Use   keys or 10 key pad to set weight

Message reads:

PRESS ENTER

Press 

SELECT WORKOUT



Press Desired WORKOUT Key



LED on workout key is lit. Profile of workout appears on dot matrix panel.

Message reads:

SET LEVEL

USE   keys or 10-key pad to set level.

NOTE:

As level is changed, work level appears in that window and corresponding maximum Watts for that workout level appears in its window.

When key is released, message reads:

PRESS ENTER



Press 

ENDU

PRE-PROGRAM WORKOUT

Message reads:

SET TIME 30:00

Use   Key or 10-key pad to set time.

Message reads:

PRESS ENTER

Press 

Message reads:

PRESS START

Press 

NOTE:

If start key is pressed any time during set up, workout starts using whichever parameters have been entered to that point.

REMINDER:

The key allows user to change the value of parameter to be entered during set-up. During run mode, pressing will reset time and distance. In effect, restarting the workout.

NOTE:

When in run mode user may switch from one workout to the next selected, joining the workout in process at the same time as the previous workout.

EXAMPLE:

Working out in weight loss at the 15:00 mark, user pressed CV Workout, computer and readout reflects move to CV Workout and resumes countdown at 15:00.

NOTE:

User is allowed to adjust level during run mode by pressing

either   key.

Remainder of workout will follow program relative to new level selected.

RANCOE®

RANDOM WORKOUT

Begin pedaling
Message reads:

SET WEIGHT 150

Use either   key or 10-key pad to set weight.

Message reads:

PRESS ENTER

Press 

Message reads:

SELECT WORKOUT



Press



LED on workout key is lit.

Message reads:

SET LEVEL

Use   key or 10-key pad to set level.

NOTE:

As level is being selected number of level appears in work level window with the corresponding wattage maximum for the program in the watts window. Profile of random program appears in the dot matrix.



ENDU

RANDOM WORKOUT



When keys are released message reads:

PRESS ENTER

Press 

Message reads:

SET TIME 30:00

Use   Key or 10-Key pad to set time (15:00-99:00)

Message reads:

PRESS ENTER

Press 

Message reads:

PRESS START



Press 

NOTE:

User may select another profile by continuing to press the random key until they find a profile they like.

NOTE:

These pre-programmed levels are limited to predetermined Watts. If user wants to increase resistance above that, they can use the keys to increase to

available machine maximum (275) Watts for the  .

NOTE:

User can move to other workouts from this workout as well.



RANCE®

USING THE HEART RATE CONTROL

ABOUT HEART RATE CONTROL

Your ENDURANCE Bike offers two options for Heart Rate Control and Feedback; you may choose to use the convenient Hand Contact Bars or the hands-free Wireless Chest Transmitter (recommended for the Heart Rate Control Program).

CONTACT BAR HAND POSITION

Place the palm of your hands directly on the Contact Pads. Both hands must grip the bars for your Heart Rate to register.

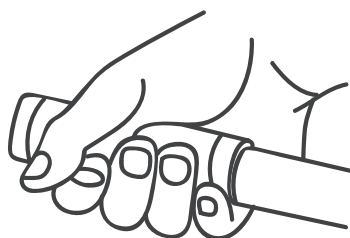

WIRELESS CHEST TRANSMITTER

Prior to wearing the Strap on your chest, moisten the two rubber contact strips with several drops of water and spread about with your fingers.

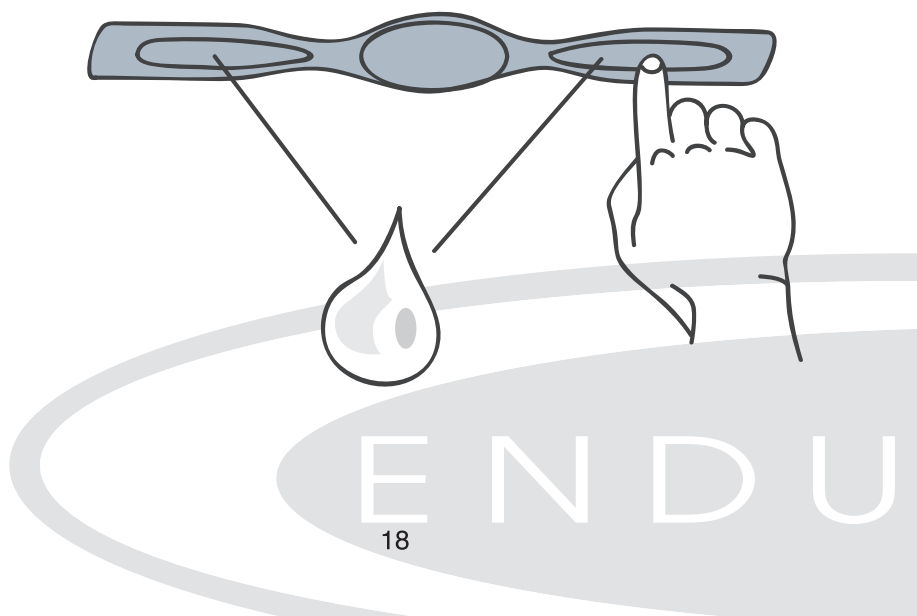

TRANSMITTER STRAP PLACEMENT

Center the Transmitter Strap just below the breast or pectoral muscles (1 to 2 inches). Women should be

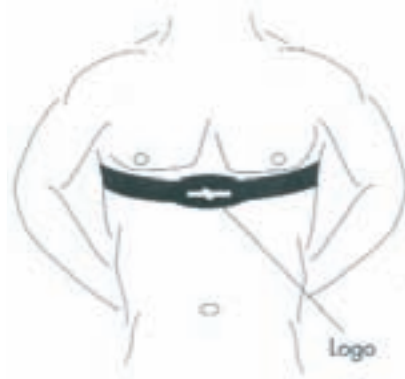

careful to place the transmitter below their bra line. Initially, the transmission signal for heart rate may be erratic or non-existent. Perspiration on your skin is necessary for proper transmission. In most cases, by the end of your warm up, transmission becomes consistent and accurate. If not, saline solution should be used to moisten the sensors on the back of the strap.

If no transmitter is available, hold contact pads on handle bars to get heart rate. The Heart light on the LED will flash, showing that the heart rate signal is received.

RANCE®

NOTES



HEART RATE CONTROL

TO USE TARGET HRC WORKOUTS:

Begin pedaling (computer starts up at 25RPM)

Message reads:

SET WEIGHT 150

Use 10-key Pad or



to set weight.

Message reads:

PRESS ENTER

Press



Message reads:

SET WORKOUT

Press



Message reads:

PRESS ENTER

Press



Message reads:

SET HR 80 (80 default value for heart rate)

Use 10-key pad or



key to set heart rate.

Message reads:

SET TIME 30:00

Use 10-key pad or



key to set time.

RANCO®

HEART RATE CONTROL

Message reads:

PRESS START



Press

ENTER



Message reads:

WARM UP

Time will count up until heart rate reaches minus 10 beats from target.

Message reads:

BEGINNING HR

When user reaches end of time entered, computer beeps and begins counting up.

Message reads:

COOL DOWN

All other data continues to accumulate.

HEART RATE SAFETY PARAMETERS

Your ENDURANCE product computer software is programmed with the following safety parameters:

- If your heart rate exceeds your target by 12 beats, there will be a 30% reduction in workload to reduce your heart rate.
- If your heart rate exceeds your target by 20 beat, the unit will automatically shut off as a precautionary measure. (Be cautious when selecting your target heart rate as determined by your physician).

NOTE:

If user changes workload manually during any heart rate workout, they will exit from the heart rate workout and be transferred into the manual workout.



ENDU

CRUISE CONTROL

CRUISE CONTROL HEART RATE CONTROL

Here's the simplest way to enter target heart rate training. While in any workout, you can easily Target Heart Rate Control by simply pressing the Target Heart Rate key.

n Secure heart rate transmitter around chest or hold on to contacts.

Begin workout, heart rate will be displayed as it is picked up. When you reach desired heart rate, press



NOTE:

To change target heart rate either use 10-key pad to set new target heart rate or press cruise control key. If 10-key pad is used, computer adjusts to new workload either by adding or taking away resistance to help user get to new target heart rate.

Or press again.



HEART RATE SAFETY PARAMETERS

Your ENDURANCE product computer software is programmed with the following safety parameters:

If your heart rate exceeds your target by 12 beats, there will be a 30% reduction in workload to reduce your heart rate.

If your heart rate exceeds your target by 20 beat, the unit will automatically shut off as a precautionary measure. (Be cautious when selecting your target heart rate as determined by your physician).

NOTE:

If user changes workload manually during any heart rate workout, they will exit from the heart rate workout and be transferred into the manual workout.

ENDURANCE®

TARGET HEART RATE ZONE

Your Target Heart Rate Zone is a percentage of your maximum heart rate. Target Zone will vary for each individual, depending on age, current level of conditioning, and personal fitness goals. The American College of Sports Medicine recommends working-out at a Target Heart Rate Zone of between 60% of maximum heart rate. See the chart below for convenient reference.

EXAMPLE:

For a 35-year old user: find AGE along the bottom of the chart, follow the AGE column up to TARGET ZONE bar. RESULTS: 60% of maximum Heart Rate = 111 Beats per Minute, 75% of maximum Heart Rate = 139 Beats per Minute. With this Target Zone of 111 -139 Beats per Minute it is best to enter an average Target Heart Rate of about 118 Beats per Minute into the Console.

HEART RATE TRAINING ZONE							
MAX	BEATS PER MINUTE						
85%	170	161	153	144	136	128	
70%	140	133	126	119	112	105	
60%	120	114	108	102	96	90	
AGE	20	30	40	50	60	70	

ENDU

BENEFITS

BENEFITS

- Weight Loss-Helps you maintain an optimum exercise level to burn fat.
- Efficient-Quantifies your exercise level for maximum benefit.
- Time Saver-Makes the most of your limited workout time.
- Motivation-Provides encouragement to achieve your fitness goals and reach for new heights.

WARNING

Consult your physician to determine your target heart rate before using the heart rate control mode of this product!

The above chart is to be used only as an average reference point and is in NO WAY a recommendation of your personal abilities!

Medications may affect your heart rate. Consult your physician for specific advice before exercising.

Do not use this product if you have an acute illness, cold or fever.

STOP EXERCISING IF ANY OF THE FOLLOWING OCCURE:

- YOU FEEL FAINT OR DIZZY
- YOU EXCEED YOUR MAXIMUM HEART RATE AS SET BY YOUR PHYSICIAN.

The logo for RANCOE is a large, light gray, teardrop-shaped graphic. Inside the shape, the word "RANCOE" is written in a white, sans-serif font. A registered trademark symbol (®) is located to the upper right of the letter "E".

RANCOE®

LIMITED HOME USE WARRANTY

ENDURANCE is proud to offer you the following warranty, which applies to home use residential, non-commercial purposes only. Any other use of the device will void this warranty.

ENDURANCE hereby extends the following limited warranties for the following components of the device, for the period indicated:

FRAME- LIFETIME ENDURANCE warrants the frame against defects in workmanship and materials for the life of the product, so long as it remains in the possession of the original owner.

Braking System

Electronics & Parts -3 years. ENDURANCE warrants the Electronic Components and all original Parts against defects in workmanship and materials for a period of three years from the date of original purchase, so long as the device remains in the possession of the original owner.

Labor-1 year. ENDURANCE shall cover the Labor Cost for the repair of the device for a period of 1 year from the date of original purchase, so long as the device remains in the possession of the original owner.



LIMITED LIGHT COMMERCIAL WARRANTY

Up to 5 hours use per day

LIGHT COMMERCIAL USES DEFINED ENDURANCE warrants models For use in light commercial facilities including: Hotels, Resorts, Police & Fire Stations, Apartment Complexes, Corporate Fitness Centers, Hospitals, Rehabilitation and Sports Medicine Clinics, where average use is up to five hours per day. Not warranted for private Health Clubs, YMCA's or Schools.

FRAME, BRAKE, ELECTRONICS & PARTS-2 years ENDURANCE FITNESS warrants the frame, Magnetic Brake, Electronic components and all original Parts against defects in workmanship and materials for a period of 2 years from the date of original purchase, so long as the device remains in the possession of the original owner.

LABOR - 1 year ENDURANCE shall cover the Labor cost for the repair of the device for a period of 1 year from the date of original owner.

EXLUCISVE REMEDY

The exclusive remedy for any of the above warranties shall be repair of replacement of defective Parts, or the supply of Labor to cure any defect, provided that Labor shall be limited to two years. The local retailer shall supply all labor and the product must be located within that retailer's service area. Products located outside the retailer's service area will not be covered by the labor warranty.

The logo for RANCE is displayed in a large, light gray, stylized shape that resembles a teardrop or a speed cap. The word "RANCE" is written in white, uppercase, sans-serif letters across the middle of the shape. A registered trademark symbol (®) is located to the right of the letter "E".

RANCE®

LIMITED LIGHT COMMERCIAL WARRANTY (continued)

Up to 5 hours use per day

EXCLUSIONS AND LIMITATIONS

This warranty applies only to the original owner and is not transferable. This warranty is expressly limited to the repair or replacement of a defective Frame, Magnetic Brake, Electronic component, or defective Part and is the sole remedy of the warranty. The warranty does not cover normal wear and tear, improper assembly or maintenance, or installation of parts or accessories not originally intended or compatible with the Fitness Product as sold. The warranty does not apply to damage or failure due to accident, abuse, corrosion, discoloration of paint or plastic, or neglect. ENDURANCE or its vendors may sometimes be supplied as warranty replacement parts and constitute fulfillment of warranty terms. Any warranty replacement parts shall be warranted for the remainder of the original warranty term. ENDURANCE expressly disclaims all other warranties, express or implied, including but not limited to all warranties of fitness for a particular purpose or of merchantability. This warranty gives you specific legal rights and your rights may vary from state to state.

WARRANTY REGISTRATION

Your warranty card must be completed and sent to ENDURANCE BEFORE A WARRANTY CLAIM CAN BE PROCESSED.

You may also register via our website at www.bodysolid.com. Inside the enclosed warranty card you will find a customer survey. Your care in completing the survey will be of value to us in serving you in the future. Comments and suggestions are always welcome. We are certain you will enjoy your new Fitness Bike. Thank you for selecting a ENDURANCE product.



LIMITED LIGHT COMMERCIAL WARRANTY

Up to 5 hours use per day

LIGHT COMMERCIAL USES DEFINED ENDURANCE warrants models For use in light commercial facilities including: Hotels, Resorts, Police & Fire Stations, Apartment Complexes, Corporate Fitness Centers, Hospitals, Rehabilitation and Sports Medicine Clinics, where average use is up to five hours per day. Not warranted for private Health Clubs, YMCA's or Schools.

FRAME, BRAKE, ELECTRONICS & PARTS-2 years ENDURANCE FITNESS warrants the frame, Magnetic Brake, Electronic components and all original Parts against defects in workmanship and materials for a period of 2 years from the date of original purchase, so long as the device remains in the possession of the original owner.

LABOR - 1 year ENDURANCE shall cover the Labor cost for the repair of the device for a period of 1 year from the date of original owner.

EXCLUSIVE REMEDY

The exclusive remedy for any of the above warranties shall be repair or replacement of defective Parts, or the supply of Labor to cure any defect, provided that Labor shall be limited to two years. The local retailer shall supply all labor and the product must be located within that retailer's service area. Products located outside the retailer's service area will not be covered by the labor warranty.

The logo for RANCO is a stylized, elongated shape resembling a bullet or a drop, with a white outline and a light gray fill. The word "RANCO" is written in white, uppercase, sans-serif letters across the center of the shape. A registered trademark symbol (®) is located to the upper right of the letter "O".

RANCO®

DEVELOPING A FITNESS PROGRAM

WARM UP:

Warming up is an extremely important phase, but unfortunately, it's often an activity that is ignored and painful, frustrating muscle pulls or strains may be the result. There are two goals for warm - up: warming up the muscles of the back and the extremities (so that you can stretch them without injury),and slight acceleration of the heart rate so the body can move gradually into the target heart rate.

Warm - ups should consist of 5-10 minutes of exercises that are not very demanding: marching in place, stepping side to side and swinging your arms walking at a pace of about 3.5mph, ect. (your heart rate should be between 90 - 120.

A gradual warm - up will do the following:

Produce faster more forceful muscle contractions.

Increase your metabolic rate so oxygen is delivered to the working muscles more quickly.

Leads to efficient calorie burning by increasing your core body temperature Prevent injuries by improving the elasticity of your muscles.

Allow you to work out comfortable longer because your energy systems are able to exercise, preventing the buildup of lactic acid in the blood.

Improves joint range of motion.

Psychologically prepares you for higher intensities by increasing your arousal and focus on exercise.

Warm - up: Warm - up 5 to 10 minutes before aerobic activity.

Duration: Maintain your exercise intensity for 20 to 60 minutes.

Cool Down: Gradually decrease the intensity of your workout, then stretch to cool down during the last 5 to 10 minutes.

NOTE: If weight loss is your major goal, a minimum of 30 minutes of aerobic activity five or more times per week is recommended.



ENDU

FLEXIBILITY

Adequate flexibility is the ability to move your limbs and joints easily (through a complete range of motion) the way you need to in order to meet the challenges of daily life. Fortunately there is a positive reinforcing cycle between flexibility and activity. Adequate flexibility enables you to maintain an active lifestyle, and an active lifestyle makes an important contribution to maintaining adequate flexibility. These relationships grow stronger the older we become.

When should I stretch?

Any time is a good time to Stretch. In the morning it can work out the kinks in your back, at work, you can relax your neck and shoulders, and after work stretch out your lower back. However, you should never do your stretches before you have had a chance to warm your body up.

How should I stretch?

Perform the following stretches slowly and smoothly until you feel a slight "tugging" sensation on the muscles involved. Don't stretch to the point you feel pain, and don't bounce -you could pull a muscle. Hold each stretch for 10 to 20 seconds. Exhale through the stretch, and breathe slowly. This will keep you from bouncing.

1. Calf (back of lower leg)

- a. Straight knee; start with the leg to be stretched approximately three feet from the wall and the opposite leg on step forward. Lean toward the wall, keeping your heels down and feet turned in slightly.
- b. Bent knee; start same as above, but move approximately one foot closer to the wall and bend the knee of the leg to be stretched.
- c. Repeat using the other leg.

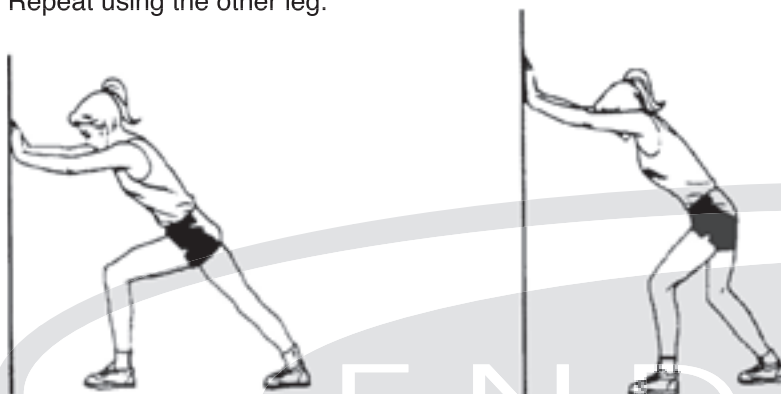

FLEXIBILITY

2. Iliotibial Band (outside of hip)

- a. Start with the leg to be stretched one step back and behind the opposite foot. Move your hips sideways toward the side of your body being stretched. Keep the upper body away from the wall and do not bend forward.
- b. Repeat using the other leg.



3. Lower Back, Hips, Groin, and Hamstrings

- a. Stand with the feet about shoulder-width apart and pointed straight ahead. If you are pretty flexible and need more of a stretch, cross one leg in front of the other for a few stretches, then switch legs.
- b. Slowly bend forward from the hips, always keeping your knees slightly bent.
- c. Stretch only to the point where you feel a tugging in the back of your legs.



4. Side Bends

- a. Stand with your feet about shoulder-width apart and toes pointed straight ahead. Keep your knees slightly bent, one hand on your hip; extend your other arm up and over your head. Slowly bend at your waist to one side, toward the hand on your hip
- b. Extend both arms overhead. Hold your right hand with your left hand and bend slowly to the left, using your left arm to pull the right arm gently over the head and down toward the ground.
- c. Repeat with other side.

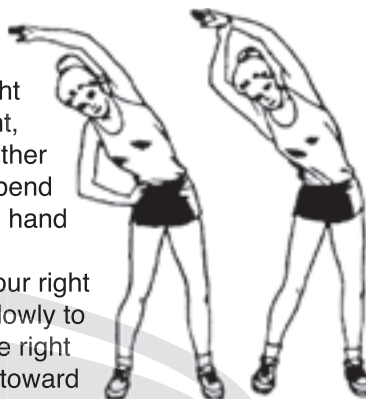

FLEXIBILITY

5. Quadriceps (front of thigh)

- Lying on our stomach, pull the heel toward your buttocks with the opposite hand. Keep the thigh of the leg being stretched close to the leg on the floor.
- The same stretch can be done standing. Do not allow the thigh to come in front of you and so not bend forward at the waist.
- Do this exercise twice - once on each leg.

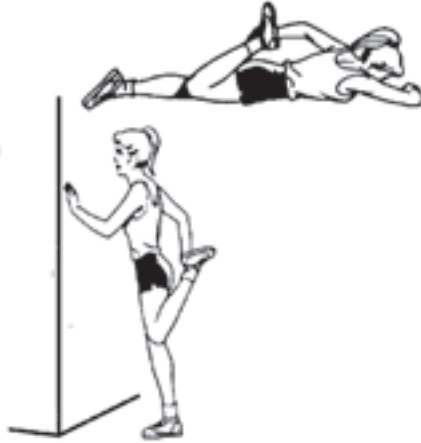

6. Groin (inside of thigh)

- Sit on the floor with the soles of your feet together. Gently push knees down toward the floor with your elbows.
- Stand with your feet three to four feet apart and turned out slightly. Keep the knee of the leg to be stretched straight, and bend the opposite knee as you move your body toward the bent leg. Keep your toes pointed forward.
- Repeat using the other leg



7. Hamstrings (back side of upper leg)

- Sit with one knee bent and the leg to be stretched out straight. Reach for the toes of the straight leg with the right hand and then the left hand.
- Repeat with the other leg.



FLEXIBILITY

8. Gluteus (back of hip)

- Lie on your back. Pull one knee up to your chest while keeping the opposite leg down on the floor with the knee straight.
- The same may be done standing.
- Repeat with the other leg.

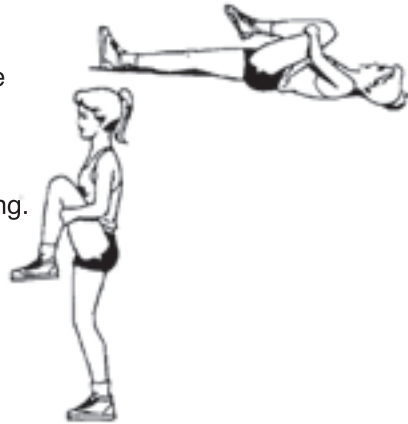

9. Anterior Tibialis (front of shin)

- Stand with all of your weight on one leg. Extend the opposite leg forward and flex and point at the ankle.
- Repeat with the other leg.

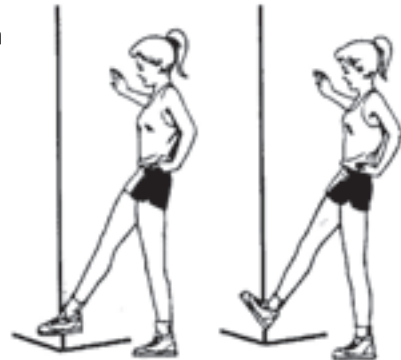

10. Iliopsoas (lower back)

- If you have a neck problem, be very careful with this stretch. In a sitting position (on a mat or rug) hold your knees with your hands and pull them to your chest.
- Gently roll up and down your spine, keeping your chin down toward your chest. This will further stretch the muscles along the spine.
- Try to roll evenly and with control. Roll back and forth 4 to 8 times or until you feel your back loosen.

Exercise Guidelines

The American Council of Sports Medicine (ACSM) recommends the following exercise guidelines, for healthy aerobic activity:

Warm-up : Warm-up 5 to 10 minutes before aerobic activity.

Duration : Maintain your exercise intensity for 20 to 60 minutes.

Cool Down : Gradually decrease the intensity of your workout, then stretch to cool down during the last 5 to 10 minutes.

NOTE: If weight loss is your major goal, a minimum of 30 minutes of aerobic activity five or more times per week is recommended.

Determining your target heart rate (Kavvonen Heart Rate Formula)

Example: 40 year old with a resting rate pulse of 60 BPM

$$220 - 40 (\text{age}) = 180$$

$$180 - 60 (\text{resting pulse}) = 120$$

$$120 \times .5 (50\% \text{ intensity}) = 60$$

$$60 + 60 (\text{resting pulse}) = 120 (\text{target heart rate})$$

The following chart explains how to determine your target heart rate for varying levels of intensity. The different levels of intensity will help you achieve different objectives.

Training Zones			
Zone	intensity (%MHR)	Goal	Mode
1	50-60%	Improve health and well-being, decrease stress, reduce risk factors,	Very easy, conversational pace.
2	60-70%	Weight management and optimal fat burning	Easy pace, longer duration to build endurance.
3	70-80%	Aerobic fitness,	Faster pace, improve stamina.
4	80-85%	Aerobic / Anaerobic fitness	Increase speed and improve stride.
5	85-100%	Anaerobic fitness for peak performance and competition	Interval runs to increase VO2 MAX, speed, economy, and form.

ACHIEVING YOUR FITNESS GOALS

Each of us are individuals with possibly different fitness goals. It is critical to determine what your goals are when developing a long term fitness program. ENDURANCE FITNESS products are pleased with your decision in using our quality products to help reach your fitness goals. Below are some benefits of exercising. We have listed these to help in reaching your fitness goals:

- Strengthens heart and lungs
- Increases energy
- Lowers blood pressure
- Increases metabolism
- Prevents diabetes
- Strengthens bones
- Strengthens and tones muscles
- Maintains weight loss
- Improves productivity
- Improves sleep
- Reduces stress
- Improves posture and appearance
- Reduces feelings of depression
- Improves sense of well-being

The logo for Endurance Fitness is a large, light gray, teardrop-shaped graphic that tapers to the right. Inside this shape, the word "ENDURANCE" is written in a white, sans-serif, all-caps font. The letter "E" at the end of the word has a registered trademark symbol (®) to its upper right.

ENDURANCE®

SAMPLE GOALS

It's important that your goals are well defined and reachable. Put your goals in writing. The more specific you are the easier it will be to keep track of your progress. Setting long term goals are best reached if one incorporates short term goals in order to reach the overall long term goal. The ENDURANCE product console provides you with several readouts that can be used to record your progress. You can track Distance, Calories or Time. Time is the most important and useful of the test functions.

SAMPLE GOALS:

Goal setting is a popular motivational technique. It's important to set goals and reward yourself when initiating a new exercise program because you're attempting to break current patterns and form a new habit. Whether you use this technique or another, make fitness a priority in your life. You can achieve the ultimate reward to yourself: you can establish the exercise habit!

Some sample goals may be:

To strengthen my heart by exercising 30 minutes three days a week.

(Goal Measurement: Exercise Time 90 minutes a week.)

To improve my bodies ability to utilize and burn fat at a higher rate by exercising at a low intensity for 45 minutes per session, 5 days per week.

(Goal Measurement: Exercise Time = 225 per week).

To decrease work other daily stress by exercising for 20 minutes a day on work days.

(Goal Mesurement: Exercise Time = 100 minutes per week).

KEEPING AN EXERCISE Diary

Feel free to photocopy the following weekly and annual log sheet. By doing so you can proudly check and return to look at the progress you have made.

The logo for ENDU is a large, light gray oval shape. Inside the oval, the word "ENDU" is written in a white, sans-serif, all-caps font. The letters are spaced out and centered within the oval.

ENDU

Diary

Week # _____

Date: _____

Number hours of sleep: _____

Weekly Goals: _____

Scheduled work out time: _____

Reward: _____

Level of intensity by % of your predicted maximal heart rate:

<i>Day</i>	<i>Date</i>	<i>Workload Level</i>	<i>Exercise Time</i>	<i>Distance</i>
<i>Sunday</i>				
<i>Monday</i>				
<i>Tuesday</i>				
<i>Wednesday</i>				
<i>Thursday</i>				
<i>Friday</i>				
<i>Saturday</i>				
<i>Totals</i>				

Rating of your perceived exertion (R.P.E., Borg Scale)

6 13 Some What Hard

7 Very, Very Light 14

8 15 Hard

9 Very Light 16

10 17 Very Hard

11 Fairly Light 18

12 19 Very, Very Hard

Photocopy and use on a weekly basis.

RANCOE®

HEART RATE CONVERSION

HEART RATE CONVERSION FOR 10 SECONDS (USE AS REFERENCE)

11 = 66 19 = 114 27 = 162

12 = 72 20 = 120 28 = 168

13 = 78 21 = 126 29 = 174

14 = 84 22 = 132 30 = 180

15 = 90 23 = 139 31 = 186

16 = 96 24 = 144 32 = 192

17 = 102 25 = 150 33 = 198

18 = 108 26 = 156 34 = 204





Endurance-Warranty Department
1900 S. Des Plaines Ave.
Forest Park, IL 60130
Phone: 1-800-556-3113
Fax: 1-708-427-3598
service@bodysolid.com

