

# euø style™

## Assembly Instructions Raina Side Table



A (1 pc)



B (1 pc)



C (1 pc)



D (5 pcs)

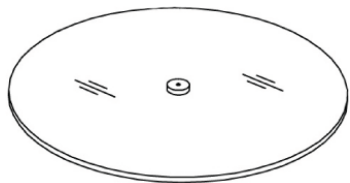

E (1 pc)

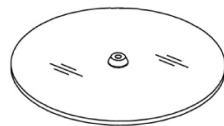

F (1 pc)

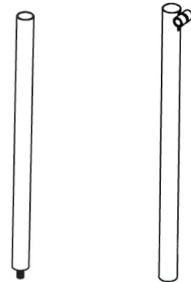

G (1 pc)

H (1 pc)



ALLEN WRENCH

PLEASE NOTE: Check that you have received all components and hardware before assembling. If you are missing any parts, contact your retailer, or fax Euro Style at 415.455.8033.

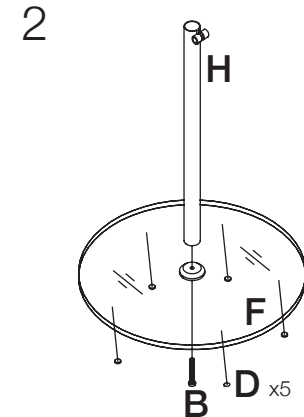
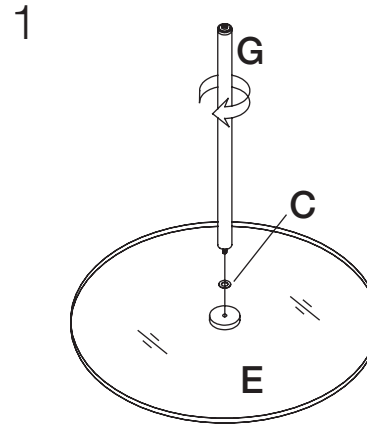

Attach the lower stainless steel tube (Part H) to the glass base (Part F) by tightening the metal screw (Part B) with the Allen Wrench. To ensure that the table is sturdy please make sure that this screw is fully tightened.

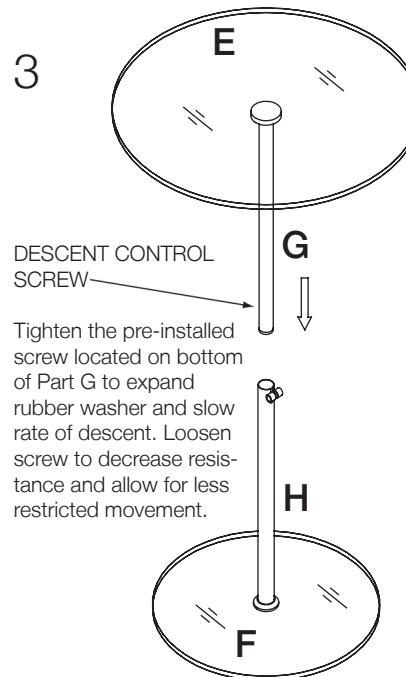

DESCENT CONTROL SCREW

Tighten the pre-installed screw located on bottom of Part G to expand rubber washer and slow rate of descent. Loosen screw to decrease resistance and allow for less restricted movement.

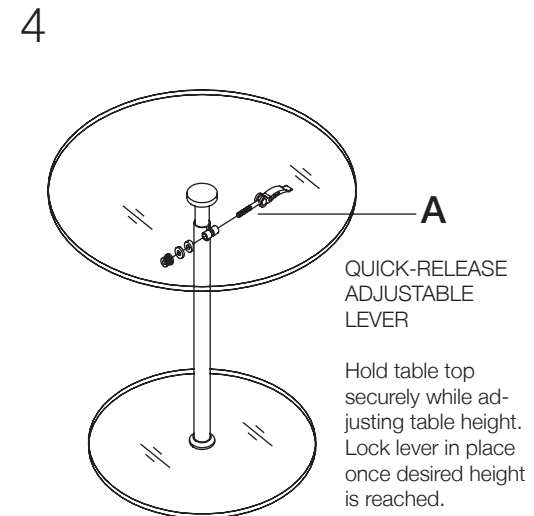

QUICK-RELEASE ADJUSTABLE LEVER

Hold table top securely while adjusting table height. Lock lever in place once desired height is reached.