

Type	-10	-28	-31
P9200	<input type="checkbox"/>	<input type="checkbox"/>	<input type="checkbox"/>
P9201	<input type="checkbox"/>	<input type="checkbox"/>	<input type="checkbox"/>
P9202	<input type="checkbox"/>	<input type="checkbox"/>	<input type="checkbox"/>

Catalog No.	Finish			Lamping	Dimensions (Inches)	
	Polished Brass	White	Black		A	B
P9200	N/A	-28	-31	75PAR16/50R/PAR20	3-1/2	7-5/8
P9201	-10	-28	-31	75PAR30/65BR30	4-3/8	8-3/4
P9202	N/A	-28	-31	300BR40/250PAR38	5-5/8	10-7/8

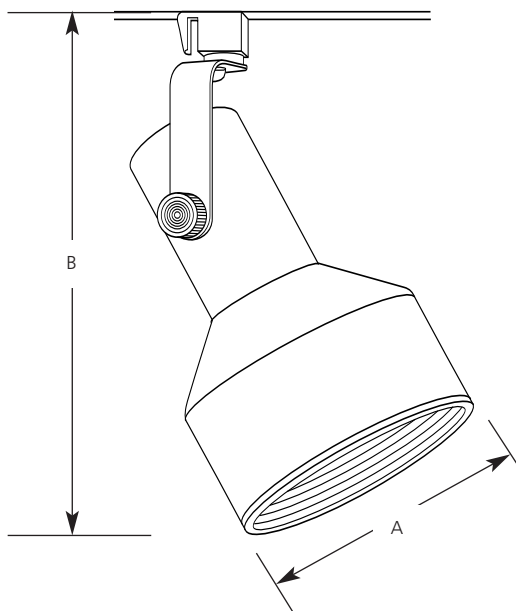

Specifications:

Track Lock Up

- For use with Alpha (P9100 Series) track
- Polarity oriented
- Quarter-turn locking action
- Tab lock to track to prevent accidental removal

- White baffle option
 - P9200 uses a P9118-28 white option
 - P9201 uses a P9119-28 white option
 - P9202 uses a P9120-28 white option

Track Head Support

- Steel half yoke
- 358-degree horizontal rotation
- P9200 & P9201 have self-locking pivot for vertical head positioning
- P9202 has external lock nut for vertical head positioning

Accessories

- Barn doors
 - P9200 order P8513
 - P9201 order P8514
 - P9202 order P8515

Track Head

- One piece steel construction
- Socket mount – two screws to prevent turning
- Porcelain socket with nickel-plated brass screw shell

Labeling

- UL-CUL dry location listed

Photometrics

- Refer to Lamp Application Data for:
 - R20, PAR20 & PAR16
 - BR30 & PAR30
 - PAR38 & BR40

Baffle

- Furnished with phenolic black baffle
- Spring clip retention

R20, PAR16 and PAR20 Lamp Application Data

Figure 1
 Single lampholder

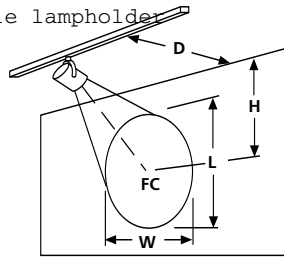
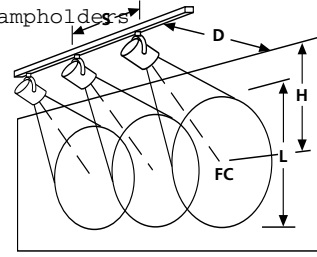

Figure 2
 Multiple lampholders



R20 Flood Lamps



Walls and Vertical Objects													Horizontal Surfaces			
H	F.C.	L	W	S	F.C.	L	W	S	F.C.	L	W	S	Clg. Ht.	F.C.	Dia. & Spacing	
				D = 2 FT				D = 3 FT				D = 4 FT				
30R20FL	2	27	2.3	1.5	1.4	19	2.4	1.9	1.8	13	2.7	2.4	2.2	8	10	2.8
CBCP - 300 Beam - 30 deg.	3	13	4.2	1.9	1.8	12	3.5	2.3	2.1	10	3.5	2.7	2.4	9	7	3.4
	4	7	7.5	2.4	2.2	7	5.1	2.7	2.4	7	4.6	3.0	2.8	10	5	3.9
50R20FL	2	47	4.0	2.3	1.9	35	3.9	3.0	2.5	25	4.3	3.7	3.1	8	18	4.2
CBCP - 550 Beam - 45 deg.	3	23	8.8	3.0	2.5	22	6.0	3.5	2.9	18	5.7	4.1	3.4	9	13	5
	4	12	26.2	3.7	3.1	13	9.9	4.1	3.4	12	8.0	4.7	3.9	10	10	5.7
P75R20	2	57	4.0	2.3	1.9	42	3.9	3.0	2.5	29	4.3	3.7	3.1	8	21	4.2
CBCP - 650 Beam - 45 deg.	3	28	8.8	3.0	2.5	26	6.0	3.5	2.9	21	5.7	4.1	3.4	9	15	5.0
	4	15	26.2	3.7	3.1	16	9.9	4.1	3.4	14	8.0	4.7	3.9	10	12	5.7

PAR16 & PAR20 Flood Lamps



PAR16



PAR20

Walls and Vertical Objects													Horizontal Surfaces			
H	F.C.	L	W	S	F.C.	L	W	S	F.C.	L	W	S	Clg. Ht.	F.C.	Dia. & Spacing	
				D = 2 FT				D = 3 FT				D = 4 FT				
45PAR16NFL	2	124	2.0	1.4	1.3	90	2.1	1.7	1.6	63	2.4	2.1	2.0	8	46	2.6
CBCP - 1,400 Beam - 27 deg.	3	60	3.6	1.7	1.6	55	3.1	2.0	1.9	45	3.1	2.4	2.2	9	33	3.0
	4	31	6.2	2.1	2.0	34	4.5	2.4	2.2	31	4.1	2.7	2.5	10	25	3.5
50PAR20NFL	3	60	4.2	1.9	1.8	55	3.5	2.3	2.1	45	3.5	2.7	2.4	8	46	2.8
CBCP - 1,400 Beam - 30 deg.	4	31	7.5	2.4	2.2	34	5.1	2.7	2.4	31	4.6	3.0	2.8	9	33	3.4
	5	18	14.1	2.9	2.6	21	7.6	3.1	2.8	21	6.2	3.4	3.1	10	25	3.9
60/75PAR16NFL	3	85	3.6	1.7	1.6	79	3.1	2.0	1.9	64	3.1	2.4	2.2	8	66	2.6
CBCP - 2,000 Beam - 27 deg.	4	45	6.2	2.1	2.0	48	4.5	2.4	2.2	44	4.1	2.7	2.7	9	48	3.0
	5	29	10.9	2.6	2.4	30	6.5	2.8	2.6	31	5.4	3.1	3.1	10	36	3.5

PAR16 & PAR20 Spot Lamps



PAR16



PAR20

Walls and Vertical Objects													Horizontal Surfaces			
H	F.C.	L	W	S	F.C.	L	W	S	F.C.	L	W	S	Clg. Ht.	F.C.	Dia. & Spacing	
				D = 2 FT				D = 3 FT				D = 4 FT				
45PAR16NSP	4	112	1.8	0.8	0.8	120	1.5	0.9	0.9	110	1.4	1.0	1.0	8	89	1.3
CBCP - 5,000 Beam - 10 deg.	5	64	2.7	0.9	0.9	76	2.0	1.0	1.0	76	1.8	1.1	1.1	10	55	1.7
	6	39	3.8	1.1	1.1	50	2.7	1.2	1.2	53	2.3	1.3	1.2	12	38	2.0
50PAR20NSP	4	149	1.3	0.8	0.8	137	1.3	0.9	0.9	118	1.3	1.0	1.0	10	110	1.2
CBCP - 6,200 Beam - 9 deg.	6	62	2.4	1.1	1.0	66	2.1	1.1	1.1	73	1.8	1.2	1.2	12	69	1.5
	8	30	4.0	1.3	1.3	35	3.2	1.4	1.4	37	2.8	1.5	1.5	14	48	1.8
60/75PAR16NSP	4	180	1.5	0.9	0.9	166	1.4	1.0	1.0	143	1.4	1.1	1.1	10	133	1.3
CBCP - 7,500 Beam - 10 deg.	6	75	2.7	1.2	1.2	80	2.3	1.3	1.2	89	2.0	1.3	1.3	12	83	1.7
	8	36	4.5	1.5	1.5	42	3.6	1.6	1.5	45	3.2	1.7	1.6	14	57	2.0

Walls and Vertical Objects

H	Height from ceiling to center of beam
D	Distance from fixture to wall
F.C.	Footcandles at center of beam
L	Length of effective lighted area
W	Width of effective lighted area
S	Spacing of multiple fixtures to effectively light wall

Horizontal Surfaces

Clg. Ht.	Height from floor to ceiling
F.C.	Footcandles 30" from floor (work plane)
Dia. & Spacing	Diameter of effective lighted area and spacing to effectively light the horizontal surface

CBCP - Center Beam Candlepower

BR30 and PAR30 Lamp Application Data

Figure 1
Single lampholder

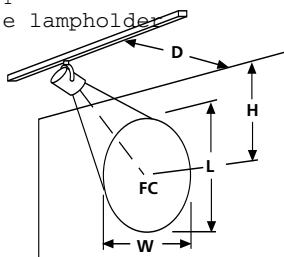
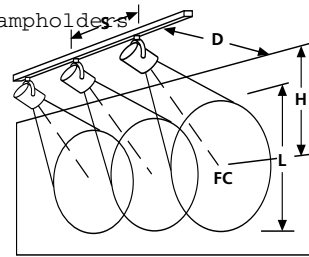

Figure 2
Multiple lampholders



BR30 Flood Lamp



BR30 Spot Lamp



PAR30
Flood Lamps



PAR30
Spot Lamps



Walls and Vertical Objects														Horizontal Surfaces		
H	F.C.	L	W	S	F.C.	L	W	S	F.C.	L	W	S	Clg. Ht.	F.C.	Dia. & Spacing	
D = 2 FT				D = 3 FT				D = 4 FT								
65BR30FL	2	46	5.7	2.9	2.3	34	5.1	3.8	2.9	23	5.6	4.7	3.6	8	17	5.1
CBCP - 525	3	22	17.3	3.8	2.9	21	8.6	4.4	3.4	17	12.0	5.2	4.0	9	12	6
Beam - 55 deg.	4	12	*	4.7	3.6	13	16.7	5.2	4.0	11	11.4	5.9	4.5	10	9	6.9
Walls and Vertical Objects														Horizontal Surfaces		
H	F.C.	L	W	S	F.C.	L	W	S	F.C.	L	W	S	Clg. Ht.	F.C.	Dia. & Spacing	
D = 2 FT				D = 3 FT				D = 4 FT								
65BR30SP	3	69	2.5	1.3	1.2	64	2.2	1.5	1.4	52	2.2	1.8	1.7	8	54	1.9
CBCP - 1625	4	36	4.0	1.6	1.5	39	3.1	1.8	1.7	36	2.9	2.0	1.9	9	38	2.3
Beam - 20 deg.	5	21	6.3	1.9	1.8	25	4.4	2.1	2.0	25	3.8	2.3	2.2	10	29	2.6
Walls and Vertical Objects														Horizontal Surfaces		
H	F.C.	L	W	S	F.C.	L	W	S	F.C.	L	W	S	Clg. Ht.	F.C.	Dia. & Spacing	
D = 2 FT				D = 3 FT				D = 4 FT								
50PAR30/HIR/FL	3	64	5.3	2.3	2.0	59	4.2	2.7	2.4	48	4.2	3.2	2.8	8	50	3.3
CBCP - 1500	4	34	10.4	2.8	2.5	36	6.4	3.2	2.8	33	5.6	3.6	3.1	9	36	3.9
Beam - 35 deg.	5	19	24.2	3.4	3.0	23	9.9	3.7	3.2	23	7.6	4.0	3.6	10	27	4.5
50PAR30FL	3	60	5.3	2.3	2.0	55	4.2	2.7	2.4	45	4.2	3.2	2.8	8	46	3.3
CBCP - 1400	4	31	10.4	2.8	2.5	34	6.4	3.2	2.8	31	5.6	3.6	3.1	9	33	3.9
Beam - 35 deg.	5	18	24.2	3.4	3.0	21	9.9	3.7	3.2	21	7.6	4.0	3.6	10	25	4.5
75PAR30FL	3	85	5.8	2.4	2.1	79	4.5	2.8	2.5	64	4.5	3.3	2.9	8	66	3.5
CBCP - 2000	4	45	12.1	3.0	2.6	48	6.9	3.3	2.9	44	6.0	3.8	3.3	9	47	4.1
Beam - 35 deg.	5	26	32.3	3.6	3.1	30	11.0	3.9	3.4	31	8.3	4.3	3.7	10	36	4.8
75PAR30FL-L	3	133	3.2	1.6	1.5	122	2.8	1.9	1.8	90	2.9	2.2	2.1	8	102	2.4
CBCP - 3100	4	70	5.5	2.0	1.9	74	4.0	2.2	2.1	68	3.7	2.5	2.3	9	74	2.8
Beam - 25 deg.	5	40	9.3	2.4	2.2	47	5.8	2.6	2.4	40	4.9	2.8	2.7	10	55	3.2
Walls and Vertical Objects														Horizontal Surfaces		
H	F.C.	L	W	S	F.C.	L	W	S	F.C.	L	W	S	Clg. Ht.	F.C.	Dia. & Spacing	
D = 3 FT				D = 4 FT				D = 5 FT								
50PAR30/HIR/NSP	4	313	1.3	0.8	0.8	287	1.3	0.9	0.9	247	1.3	1.0	1.0	12	144	1.5
CBCP - 13,000	6	130	2.4	1.1	1.0	139	2.1	1.1	1.1	154	1.8	1.2	1.2	16	71	2.1
Beam - 9 deg.	8	63	4.0	1.3	1.3	73	3.2	1.4	1.4	77	2.8	1.5	1.5	20	42	2.7
50PAR20NSP	4	166	1.5	0.9	0.9	152	1.4	1.0	1.0	131	1.4	1.1	1.1	10	123	1.3
CBCP - 6,900	6	69	2.7	1.2	1.2	74	2.3	1.3	1.2	81	2.0	1.3	1.3	12	76	1.7
Beam - 10 deg.	8	33	4.5	1.5	1.5	39	3.6	1.6	1.5	41	3.2	1.7	1.6	14	52	2.0
75PAR30NSP	4	313	1.5	0.9	0.9	287	1.4	1.0	1.0	247	1.4	1.1	1.1	10	231	1.3
CBCP - 13,000	6	130	2.7	1.2	1.2	139	2.3	1.3	1.2	154	2.0	1.3	1.3	14	98	2.0
Beam - 10 deg.	8	63	4.5	1.5	1.5	73	3.6	1.6	1.5	77	3.2	1.7	1.6	18	54	2.7
75PAR30NSP-L	4	217	1.5	0.9	0.9	199	1.4	1.0	1.0	171	1.4	1.1	1.1	10	160	1.3
CBCP - 9,000	6	90	2.7	1.2	1.2	96	2.3	1.3	1.2	107	2.0	1.3	1.3	14	68	2.0
Beam - 10 deg.	8	44	4.5	1.5	1.5	51	3.6	1.6	1.5	53.3	3.2	1.7	1.6	18	37	2.7

Walls and Vertical Objects

H	Height from ceiling to center of beam
D	Distance from fixture to wall
F.C.	Footcandles at center of beam
L	Length of effective lighted area
W	Width of effective lighted area
S	Spacing of multiple fixtures to effectively light wall

Horizontal Surfaces

Clg. Ht.	Height from floor to ceiling
F.C.	Footcandles 30" from floor (work plane)
Dia. & Spacing	Diameter of effective lighted area and spacing to effectively light the horizontal surface

CBCP - Center Beam Candlepower
*L is height of wall

PAR38 and BR40 Lamp Application Data

Figure 1

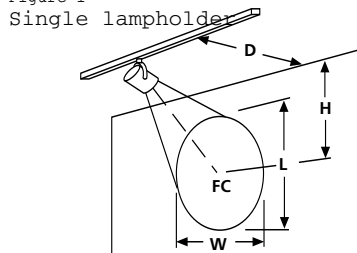
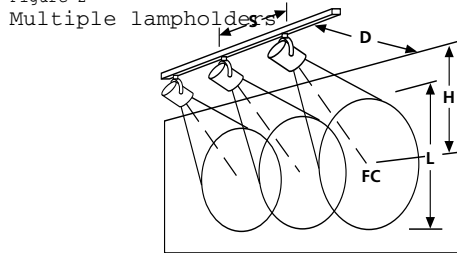

Figure 2



BR40
Flood Lamps



BR40
Spot Lamps



PAR38
Flood Lamps



PAR38
Spot Lamps



Walls and Vertical Objects														Horizontal Surfaces		
H	F.C.	L	W	S	F.C.	L	W	S	F.C.	L	W	S	Clg. Ht.	F.C.	Dia. & Spacing	
D = 2 FT																
120BR40FL	2	88	6.9	3.3	2.4	64	5.9	4.2	3.1	45	6.3	5.2	3.8	8	33	5.5
CBCP - 1,000 Beam - 60 deg.	3	43	29.9	4.2	3.1	39	10.4	4.9	3.6	32	8.9	5.8	4.3	9	24	6.5
	4	22	*	5.2	3.8	24	23.5	5.8	4.3	22	13.9	6.5	4.8	10	18	7.5
300R40FL	3	124	*	12.5	6.7	114	*	14.7	7.8	93	*	17.3	9.2	8	96	9.5
CBCP - 2,900 Beam - 120 deg.	4	65	*	15.5	8.3	70	*	17.3	9.2	64	*	19.6	10.5	10	52	13.0
	5	37	*	18.7	9.9	44	*	20.2	10.8	44	*	22.2	11.8	12	32	16.5
D = 3 FT																
120BR40SP	4	111	3.1	1.8	1.7	102	2.9	2.0	1.9	87	3.0	2.3	2.2	10	82	2.6
CBCP - 4,600 Beam - 20 deg.	6	46	6.0	2.4	2.3	49	4.9	2.5	2.4	54	4.1	2.6	2.5	12	51	3.3
	8	22	11.0	3.0	2.9	26	8.0	3.2	3.0	27	6.8	3.3	3.2	14	35	4.0
300R40SP	4	337	7.9	3.6	3.1	309	6.7	4.1	3.5	266	6.5	4.7	4.0	10	249	5.1
CBCP - 14,000 Beam - 40 deg.	6	140	23.1	4.9	4.2	149	13.5	5.2	4.5	165	9.8	5.5	4.7	12	155	6.5
	8	68	*	6.2	5.3	79	30.8	6.5	5.6	83	19.6	6.9	5.8	14	106	7.9
D = 4 FT																
75PAR38FL	3	171	3.2	1.6	1.5	157	2.8	1.9	1.8	128	2.9	2.2	2.1	8	132	2.4
CBCP - 4,000 Beam - 25 deg.	4	90	5.5	2.0	1.9	96	4.0	2.2	2.1	88	3.7	2.5	2.3	9	95	2.8
	5	51	9.3	2.4	2.2	60	5.8	2.6	2.4	61	4.9	2.8	2.7	10	71	3.2
90PAR38FL	3	222	2.7	1.5	1.4	161	2.8	1.9	1.8	122	3.0	2.3	2.1	8	136	2.4
CBCP - 4,100 Beam - 25 deg.	4	92	5.5	2.0	1.9	78	4.9	2.4	2.2	76	4.3	2.7	2.5	9	97	2.8
	5	45	11.0	2.5	2.4	41	8.3	3.0	2.8	38	7.2	3.3	3.1	10	73	3.2
120PAR38FL	3	214	4.2	1.9	1.8	196	3.5	2.3	2.1	160	3.5	2.7	2.4	8	165	2.8
CBCP - 5,000 Beam - 30 deg.	4	112	7.5	2.4	2.2	120	5.1	2.7	2.4	110	4.6	3.0	2.8	9	118	3.4
	5	64	14.1	2.9	2.6	76	7.6	3.1	2.8	76	6.2	3.4	3.1	10	89	3.9
150PAR38FL	3	193	4.2	1.9	1.8	176	3.5	2.3	2.1	144	3.5	2.7	2.4	8	148.5	2.8
CBCP - 4,500 Beam - 30 deg.	4	101	7.5	2.4	2.2	108	5.1	2.7	2.4	99	4.6	3.0	2.8	9	106.2	3.4
	5	58	14.1	2.9	2.6	68	7.6	3.1	2.8	68	6.2	3.4	3.1	10	80.1	3.9
250PAR38FL	3	132	5.3	2.3	2.0	122	4.2	2.7	2.4	99	4.2	3.2	2.8	8	102	3.3
CBCP - 3,100 Beam - 35 deg.	4	70	10.4	2.8	2.5	75	6.4	3.2	2.8	69	5.6	3.6	3.1	9	73	3.9
	5	40	24.2	3.4	3.0	47	9.9	3.7	3.2	47	7.6	4.0	3.6	10	55	4.5
D = 3 FT																
75PAR38SP	4	313	1.3	0.8	0.8	287	1.3	0.9	0.9	247	1.3	1.0	1.0	10	231	1.2
CBCP - 13,000 Beam - 9 deg.	6	130	2.4	1.1	1.0	139	2.1	1.1	1.1	154	1.8	1.6	1.2	12	144	1.5
	8	63	4.0	1.3	1.3	73	3.2	1.4	1.4	77	2.8	2.0	1.5	14	98	1.8
90PAR38SP	4	385	1.5	0.9	0.9	354	1.4	1.0	1.0	304	1.4	1.1	1.1	10	284	1.3
CBCP - 16,000 Beam - 10 deg.	6	160	2.7	1.2	1.2	171	2.3	1.3	1.2	189	2.0	1.3	1.3	12	121	2.0
	8	77	4.5	1.5	1.5	90	3.6	1.6	1.5	95	3.2	1.7	1.6	14	67	2.7
D = 4 FT																
120PAR38SP	8	338	1.8	1.0	1.0	354	1.6	1.1	1.1	330	1.6	1.2	1.2	16	137	2.1
CBCP - 25,000 Beam - 9 deg.	10	140	3.2	1.4	1.4	171	2.6	1.4	1.4	205	2.1	1.4	1.4	18	104	2.4
	12	68	5.3	1.8	1.8	90	4.0	1.8	1.7	103	3.4	1.8	1.8	20	82	2.7
150PAR38SP	8	244	2.4	1.4	1.4	255	2.1	1.5	1.5	238	2.1	1.6	1.6	12	199	2.0
CBCP - 18,000 Beam - 12 deg.	10	101	4.4	1.9	1.8	123	3.5	1.9	1.9	148	2.9	1.9	1.9	14	136	2.4
	12	49	7.4	2.4	2.4	65	5.5	2.3	2.3	74	4.6	2.4	2.3	16	99	2.8

Walls and Vertical Objects

H	Height from floor to center of beam
D	Distance from fixture to wall
F.C.	Footcandles at center of beam
L	Length of effective lighted area
W	Width of effective lighted area
S	Spacing of multiple fixtures to effectively light wall

Horizontal Surfaces

Clg. Ht.	Height from floor to ceiling
F.C.	Footcandles 30" from floor (work plane)
Dia. & Spacing	Diameter of effective lighted area and spacing to effectively light the horizontal surface

CBCP - Center Beam Candlepower
*L is height of wall