

Family: Marcellina | Item No. 4408 GR

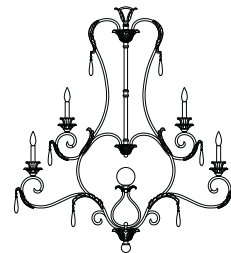

**Drawing 1 - Fixture Assembly**

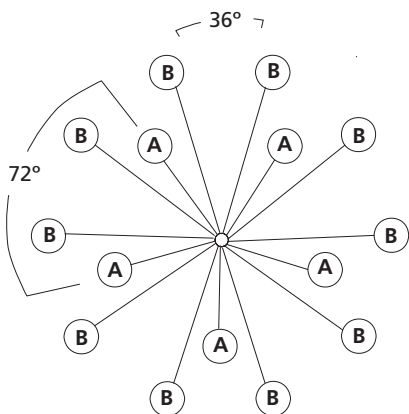

▼ start here

**1**

1. Find a clear area in which you can work.
2. Unpack fixture and glass from carton.
3. Carefully review instructions prior to assembly.

\*\*\* The construction of this fixture will be accomplished by first rotating the fixture arms into the correct position, assembling the basic fixture, installing the mounting hardware, making all necessary electrical connections, mounting the fixture to the ceiling and then hanging the crystals.

**Drawing 2 - Fixture Assembly**

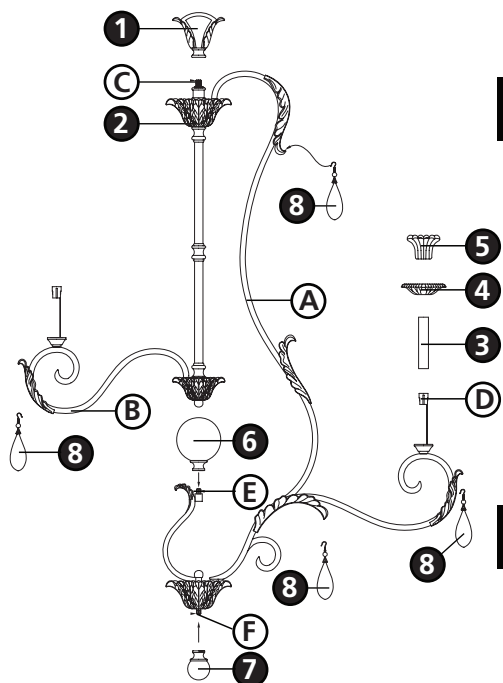

**2**

1. To assemble fixture, slip loop (1) along wire and thread onto threaded tube (C) at the top of fixture (2) - see **Drawing 2**.
2. Rotate arms (A) until they are equally spaced 72 degrees apart - see **Drawing 1**.
3. Rotate arms (B) until they are equally spaced 36 degrees apart.
4. Slip candle sleeve (3) over each socket (D) - see **Drawing 2**.
5. Slip glass bobesche (4) over candle sleeve (3).
6. Slip glass cup (5) over each candle sleeve (3).
7. Thread large crystal ball (6) onto threaded tube (E), located in the center of the fixture.
8. Fixture can now be lamped accordingly.
9. Please refer to the hanging instruction sheet (I.S. 19-50E) provided to hang fixture. Then refer back to this sheet to continue installation of this fixture.

**3**

1. To attach crystals, thread the remaining small crystal ball (7) onto threaded tube (F) at the bottom of the fixture - see **Drawing 2**.
2. Hang crystals (8) from areas indicated.

12.29.08

**Drawing 1 - Fixture Assembly**

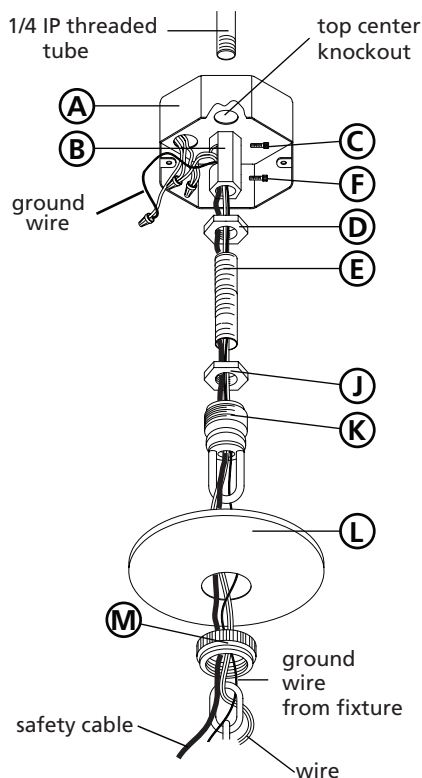

**Drawing 2 - Installation Example**

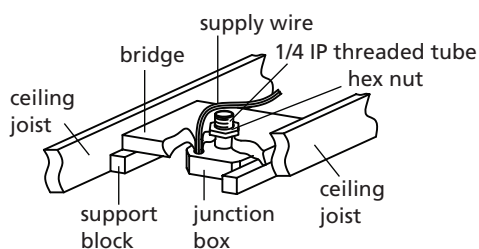

## ▼ start here

**1**

1. Shut off electrical current before starting. If the fixture you are replacing is turned on and off by a wall switch, simply turn the switch off. If not, remove the appropriate fuse (or open the circuit breakers) until the fixture is dead.

• **DO NOT RESTORE CURRENT - EITHER BY FUSE, BREAKER, OR SWITCH - UNTIL THE NEW FIXTURE IS COMPLETELY WIRED AND IN PLACE.**

2. Supply wires shall enter the outlet box (A) through any knockout EXCEPT the top center knockout - see **Drawing 1**.

**2**

1. Fixture is to be mounted by a 3/8 steel pipe with 3/8 - 18 NPSM thread, 3/4" threads at both ends (not supplied). Pipe should be anchored to structure or bridging member with sufficient strength to support 4 times the fixtures weight - see **Drawing 2**.

2. Adjust pipe so 1/2" of 3/8 steel pipe extends into the junction box, at the center knockout.

**3**

1. Thread pipe coupler (B) onto protruding pipe inside outlet box. Secure in place by tightening allen head screw (C) - see **Drawing 1**.

2. Thread hexnut (D) onto threaded nipple (E). Thread nipple (E) into coupler (B). Secure in place by tightening hexnut (D) against coupler (B) and then tightening allen screw (F).

3. Thread hexnut (J) onto nipple (E). DO NOT tighten hexnuts (J) at this time.

4. Thread screw collar loop (K). Adjust loop height so the half of the exterior thread on screw collar loop (K) is exposed when canopy (L) is held up to the ceiling.

**4**

1. Determine length of chain you will require. Attach one end of length of chain to fixture.

2. Slip threaded ring (M) and canopy (L) onto chain - see **Drawing 1**.

3. Attach fixture with chain to screw collar loop (K). Please get assistance, weight and size of fixture is difficult to manage alone.

4. Weave ground wire, and supply wire, and safety cable through chain, up through center of screw collar loop (K), through center of nipple (E), and out the opening on the side of coupler (B).

**NOTE:** Please see safety cable installation instructions on sheet to complete step 4.

5. Make electrical connections from supply wire to fixture lead wires. Refer to instruction sheet (**I.S. 18**) and follow all instructions to make all necessary wiring connections

6. After connections are made slip wires into junction box. Slip canopy along chain and up to ceiling. Thread thread ring (M) onto loop and tighten to secure canopy to ceiling.

# safety cable installation

**WARNING: TO AVOID ELECTRICAL SHOCK, THIS SECTION OF THE INSTRUCTION SHEET IS FOR THE SOLE PURPOSE OF SAFETY CABLE INSTALLATION, AND IS NOT TO BE USED TO MAKE ANY ELECTRICAL CONNECTIONS.**

- The safety cable must be attached to a ceiling joist or other permanent structure independent of the junction box

- Using a 1/8" dia., drill a pilot hole **(1)**. It must be drilled into the permanent structure or through the junction box on joist side where the safety cable is to be attached - see **Drawing 3**.
- Insert and thread a 1/4" hex head lag screw **(2)** (not included) into pilot hole.
- Continue back to previous I.S 19-50 to continue installation of this fixture.
- Wrap safety cable **(3)** around hex head lag screw **(2)** and tighten to secure cable - see **Drawing 3**.

**SAFETY WARNING: READ WIRING AND GROUNDING INSTRUCTIONS (I.S. 18) AND ANY ADDITIONAL DIRECTIONS. TURN POWER SUPPLY OFF DURING INSTALLATION. IF NEW WIRING IS REQUIRED, CONSULT A QUALIFIED ELECTRICIAN OR LOCAL AUTHORITIES FOR CODE REQUIREMENTS.**

Make electrical connections from supply wire to fixture lead wires. Refer to instruction sheet **(I.S. 18)** and follow all instructions to make all necessary wiring connections.

**Drawing 3 - Safety Cable Installation**

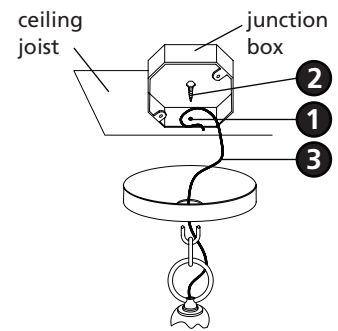

## Drawing 1 - Flush Mount

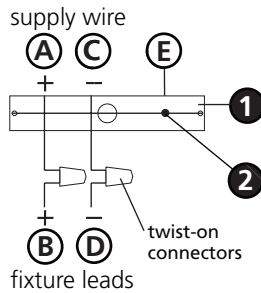

## Drawing 2 - Chain Hung

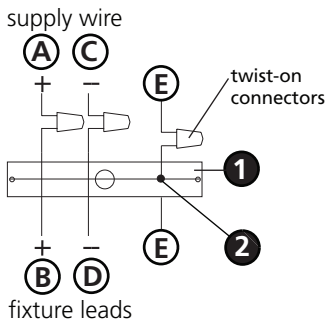

## Drawing 3 - Post-Mount

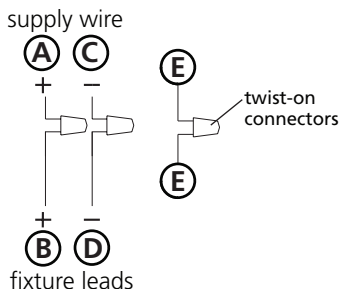

**SAFETY WARNING: READ WIRING AND GROUNDING INSTRUCTIONS (I.S. 18) AND ANY ADDITIONAL DIRECTIONS. TURN POWER SUPPLY OFF DURING INSTALLATION. IF NEW WIRING IS REQUIRED, CONSULT A QUALIFIED ELECTRICIAN OR LOCAL AUTHORITIES FOR CODE REQUIREMENTS.**

## wiring instructions

### Indoor Fixtures

1. Connect positive supply wire **(A)** (typically black or the smooth, unmarked side of the two-conductor cord) to positive fixture lead **(B)** with appropriately sized twist on connector - see **Drawings 1 or 2**.
2. Connect negative supply wire **(C)** (typically white or the ribbed, marked side of the two-conductor cord) to negative fixture lead **(D)**.
3. Please refer to the **grounding instructions** below to complete all electrical connections.

### Outdoor Fixtures

1. Connect positive supply wire **(A)** (typically black or the smooth unmarked side of the two-conductor cord) to positive fixture lead **(B)** with appropriately sized twist on connector - see **Drawings 2 or 3**.
2. Connect negative supply wire **(C)** (typically white or the ribbed, marked side of the two-conductor cord) to negative fixture lead **(D)**.
3. Cover open end of connectors with silicone sealant to form a watertight seal.
  - If installing a wall mount fixture, use caulk to seal gaps between the fixture mounting plate (backplate) and the wall. This will help prevent water from entering the outlet box. If the wall surface is lap siding, use caulk and a fixture mounting platform specially.
4. Please refer to the **grounding instructions** below to complete all electrical connections.

## grounding instructions

### Flush Mount Fixtures

For positive grounding in a 3-wire electrical system, fasten the fixture ground wire **(E)** (typically copper or green plastic coated) to the fixture mounting strap **(1)** with the ground screw **(2)** - see **Drawing 1**.

Note: On straps for screw supported fixtures, first install the two mounting screws in strap. Any remaining tapped hole may be used for the ground screw.

### Chain Hung Fixtures

Loop fixture ground wire **(E)** (typically copper or green plastic coated) under the head of the ground screw **(2)** on fixture mounting strap **(1)** and connect to the loose end of the fixture ground wire directly to the ground wire of the building system with appropriately sized twist-on connectors - see **Drawing 2**.

### Post-Mount Fixtures

Connect fixture ground wire **(E)** (typically copper or green plastic coated) to power supply ground with appropriately sized twist-on connector inside post. Cover open end of connector with silicone sealant to form a watertight seal - see **Drawing 3**.