



MODEL N° 90056

OWNER'S MANUAL

COPY

Keep this Product ID Number and use when contacting Customer Service:

REGISTER YOUR PRODUCT ONLINE AT WWW.LIFETIME.COM

At Lifetime, we are committed to providing innovative and quality products. While registering, you will have the opportunity to give us your feedback. Your input is valuable to us.

- You can also opt in to receive new product notifications or promotions.
- In the unlikely event of a product recall or safety modification, your registration provides the information we need to notify you directly.
- Registration is fast, easy, and completely voluntary.

Lifetime's Promise to You:

Maintaining your privacy is our long-standing policy at Lifetime. And you can rest assured that Lifetime will not sell or provide your personal data to other third parties, or allow them to use your personal data for their own purposes.

We invite you to read our privacy policy at www.lifetime.com

REGISTER today!

Save this owner's manual for future reference and in the event that the manufacturer has to be contacted.



Questions or Missing Parts?

ID: _____

TO SAVE TIME WHEN CONTACTING CUSTOMER SERVICE, PLEASE HAVE THE PRODUCT ID AVAILABLE BEFORE YOU CALL; IT'S LOCATED AT THE BOTTOM-LEFT CORNER OF THE FRONT PAGE OF THIS MANUAL.

****U.S. and Canada customers ONLY****

FOR CUSTOMERS OUTSIDE THE U.S. OR CANADA, PLEASE CONTACT THE STORE FOR ASSISTANCE.

DO NOT CONTACT THE STORE!
CALL OUR CUSTOMER SERVICE DEPARTMENT at
1 (800) 225-3865

HOURS: 7:00 a.m. to 5:00 p.m. Monday through Friday (Mountain Standard Time)

Call, or visit our Web site for Saturday hours



SAFETY INSTRUCTIONS



FAILURE TO FOLLOW THESE WARNINGS MAY RESULT IN SERIOUS INJURY OR PROPERTY DAMAGE AND WILL VOID WARRANTY.

To ensure safety, do not attempt to assemble this product without reading and following all instructions carefully. Check the entire box and inside all packing materials for parts and/or additional instruction material. Before beginning assembly, identify and inventory all parts and hardware using the parts and hardware lists and identifiers in this document. Proper and complete assembly, use and supervision are essential for proper orientation and to reduce the risk of accident or injury. A high probability of serious injury exists if this product is not installed, maintained, and/or operated properly. Failure to comply with any of the warnings in this instruction manual may result in serious personal injuries such as cuts, broken bones, nerve damage, paralysis, brain injury, or death. Failure to comply may also result in property damage. Please heed all warnings and cautions.

- If using a ladder during assembly, use extreme caution.
- Two capable adults are recommended for this operation.

Most injuries are caused by misuse and/or not following instructions. Use caution when using this product.

BEFORE BEGINNING ASSEMBLY



Keep the hardware bags and their contents separate. If any parts are missing, call our Customer Service Department.



Identify and inventory all parts and hardware using the parts and hardware lists and identifiers in this document.



Test fit all Bolts by inserting them into their respective holes. If necessary, carefully scrape away any excess powder coating buildup from inside the holes. Do not scrape away all of the powder coating. Bare metal may rust. You may need to pound some Bolts into place with a hammer or mallet.



TOOLS AND PARTS REQUIRED FOR THIS ASSEMBLY

9/16" Wrench

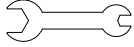

(1, included)

Allen Key

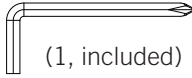

(1, included)

This system is intended for indoor use only.

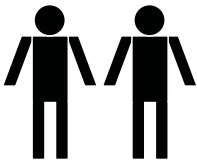

****Two adults required to complete assembly****

Only adults should set up the product. Do not allow children in the setup area until assembly is complete.

ASSEMBLY GUIDES

Refer to the following areas throughout the instructions to assist in the assembly process:

This area is located at the top, left-hand corner of the page and indicates which tools and hardware are needed to complete the assembly steps on a page.



TOOLS AND HARDWARE REQUIRED FOR THIS PAGE

This area is usually located in the bottom, left-hand corner of a step and indicates that special attention is needed to perform a particular part of a step.



Note:

These areas are usually located in the bottom, right-hand corner of a step and indicate that damage to the product or serious injury may occur if the caution or warning is not heeded.



CAUTION



WARNING

PARTS LIST

<u>ID</u>	<u>Item Description</u>	<u>Qty</u>	<u>✓</u>
AJI	Backboard	1	<input type="checkbox"/>
ALX	Rim	2	<input type="checkbox"/>
AKZ	Net	2	<input type="checkbox"/>
BLP	Ball	7	<input type="checkbox"/>
BLQ	Electronic Scoreboard	1	<input type="checkbox"/>
BLR	Electronic Power Source	1	<input type="checkbox"/>
BLS	Ball Return Net (not shown)	1	<input type="checkbox"/>
BLT	Fold-up Plate	2	<input type="checkbox"/>
BLU	Bottom Brace	1	<input type="checkbox"/>
BLV	Cross Bar	2	<input type="checkbox"/>
BLW	Lean Bar	1	<input type="checkbox"/>
BLX	Front Leg	2	<input type="checkbox"/>
BLY	Middle Leg	2	<input type="checkbox"/>
BLZ	Rear Cross Brace	2	<input type="checkbox"/>
BMA	Rear, Bottom Leg	2	<input type="checkbox"/>
BMB	Rear, Middle Leg	2	<input type="checkbox"/>
BMC	Rear, Top Leg	2	<input type="checkbox"/>
BOF	Side Rail	1	<input type="checkbox"/>
BMD	Side Rail with Push Button	1	<input type="checkbox"/>
BME	Height Spacer	2	<input type="checkbox"/>
BMF	Upper, Middle Leg	2	<input type="checkbox"/>
BQB	Ball Pump and Needle (not shown)	1	<input type="checkbox"/>
BPV	Pinch Warning Sticker (applied to BLT)	2	<input type="checkbox"/>
BPU	Fold Up Warning Sticker (applied to BMD)	1	<input type="checkbox"/>

HARDWARE LIST

<u>ID</u>	<u>Item Description</u>	<u>Qty</u>	<u>✓</u>
	<i>Hardware Blister Pack (1055075)</i>		
BMJ	3/8" x 1" Button Head Cap Screw	8	<input type="checkbox"/>
AAF	3/8" Washer	12	<input type="checkbox"/>
BKJ	3/8" Cap Nut	26	<input type="checkbox"/>
AAP	#6 x 3/8" Phillips Pan Head Screw	8	<input type="checkbox"/>
BNZ	M5 x 15mm Screw	4	<input type="checkbox"/>
BOA	M5 Nylock Nut	4	<input type="checkbox"/>
AOQ	Allen/ Phillips Key	1	<input type="checkbox"/>
BPW	9/16" Wrench	1	<input type="checkbox"/>
BML	3/8" x 2" Button Head Cap Screw	6	<input type="checkbox"/>
BMN	Retaining Hook	2	<input type="checkbox"/>
BMK	3/8" x 2 1/2" Button Head Cap Screw	4	<input type="checkbox"/>
BMM	3/8" x 3 1/4" Button Head Cap Screw	6	<input type="checkbox"/>
BOC	3/8" x 3 1/2" Button Head Cap Screw	2	<input type="checkbox"/>
BOB	3/8" Plug	4	<input type="checkbox"/>
BPI	1/2" x 1 1/2" Spacer	1	<input type="checkbox"/>

PARTS IDENTIFIER

Parts shown at 5% of Actual Size

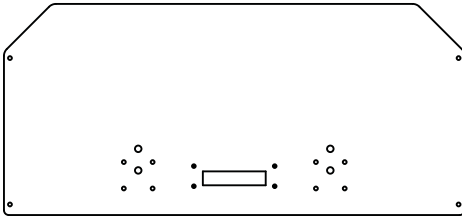

AJI (x1)
Backboard

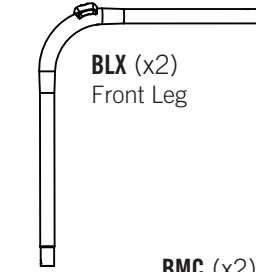

BLX (x2)
Front Leg

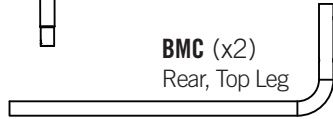

BMC (x2)
Rear, Top Leg

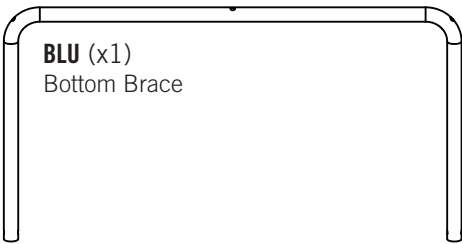

BLU (x1)
Bottom Brace

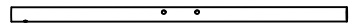

BLY (x2)
Middle Leg

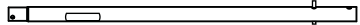

BMD (x1)
Side Rail with Push Button
(Warning Sticker Applied)

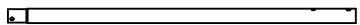

BOF (x1)
Side Rail

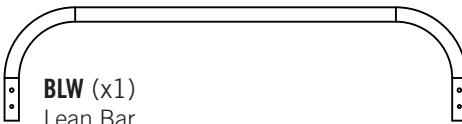

BLW (x1)
Lean Bar

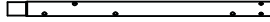

BMB (x2)
Rear, Middle Leg

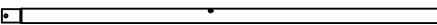

BMA (x2)
Rear, Bottom Leg

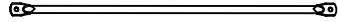

BLZ (x2)
Rear Cross Brace

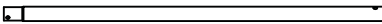

BMF (x2)
Upper, Middle Leg

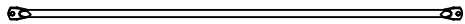

BLV (x2)
Cross Bar

Parts shown at 10% of Actual Size

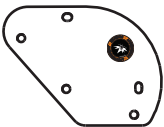

BLT (x2)
Fold-up Plate
(Warning Sticker Applied)



BLR (x1)
Electronic Power Source

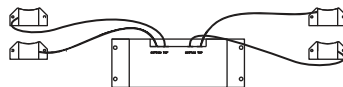

BLQ (x1)
Electronic Scoreboard

PARTS IDENTIFIER

Parts shown at 10% of Actual Size

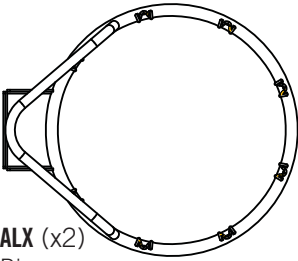

ALX (x2)
Rim

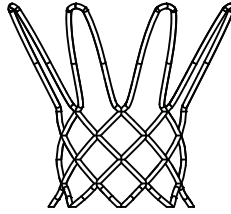

AKZ (x2)
Net



BLP (x7)
Ball

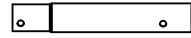

BME (x2)
Height Spacer

HARDWARE IDENTIFIER

BACKBOARD TO RIM ASSEMBLY HARDWARE

Hardware shown at Actual Size

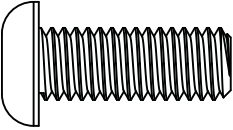

BMJ (x8)
3/8" x 1" Button Head Cap Screw



BKJ (x8)
3/8" Cap Nut

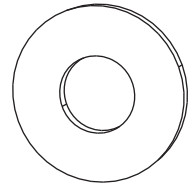

AAF (x8)
3/8" Washer



AAP (x8)
#6 x 3/8" Phillips Pan Head Screw



BNZ (x4)
15mm M5 Screw



BOA (x4)
M5 Nylock Nut

REAR FRAME ASSEMBLY HARDWARE

Hardware shown at Actual Size

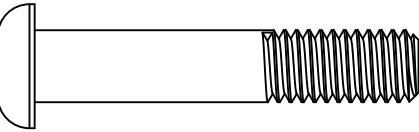

BML (x3)
3/8" x 2" Button Head Cap Screw



BKJ (x11)
3/8" Cap Nut

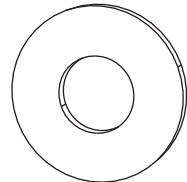

AAF (x2)
3/8" Washer

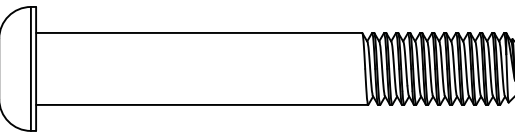

BMK (x2)
3/8" x 2 1/2" Button Head Cap Screw

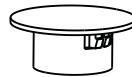

BOB (x4)
3/8" Plug

HARDWARE IDENTIFIER

REAR FRAME ASSEMBLY HARDWARE (CONTINUED)

Hardware shown at Actual Size

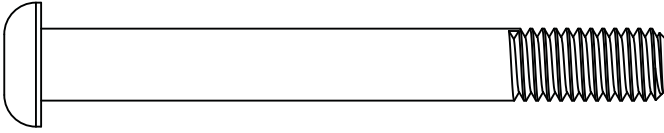

BMM (x5)
3/8" x 3 1/4" Button Head Cap Screw

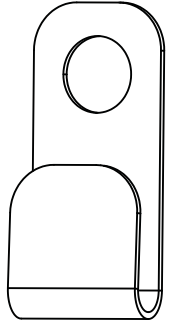

BMN (x2)
Retaining Hook

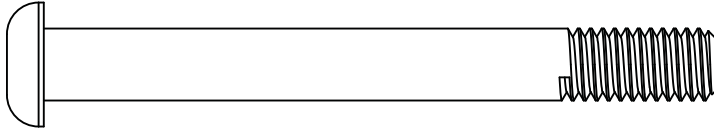

BOC (x1)
3/8" x 3 1/2" Button Head Cap Screw

FRONT FRAME ASSEMBLY HARDWARE

Hardware shown at Actual Size

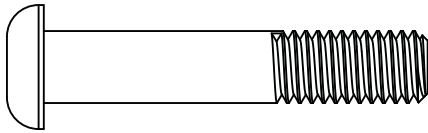

BML (x3)
3/8" x 2" Button Head Cap Screw



BKJ (x7)
3/8" Cap Nut

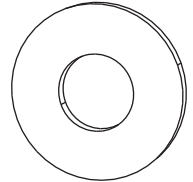

AAF (x2)
3/8" Washer

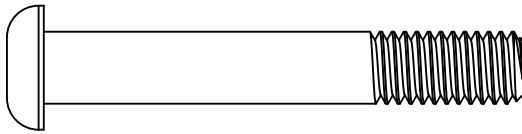

BMK (x2)
3/8" x 2 1/2" Button Head Cap Screw



BPI (x1)
1 1/2" x .437" x 1/2" Spacer

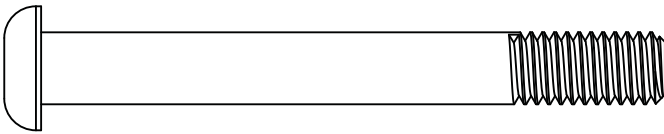

BMM (x1)
3/8" x 3 1/4" Button Head Cap Screw

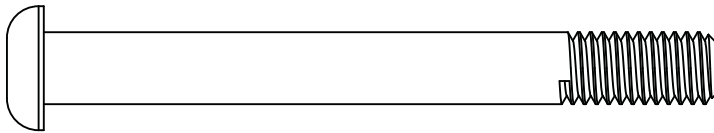

BOC (x1)
3/8" x 3 1/2" Button Head Cap Screw

SEC 1**BACKBOARD TO RIM ASSEMBLY****HARDWARE REQUIRED**

Hardware shown at Actual Size

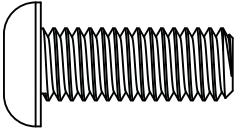
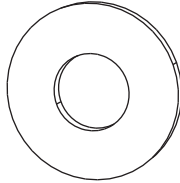
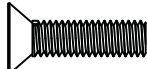
**BMJ (x8)**
3/8" x 1" Button Head Cap Screw**AAF (x8)**
3/8" Washer**BKJ (x8)**
3/8" Cap Nut**AAP (x8)**
#6 x 3/8" Phillips
Pan Head Screw**BNZ (x4)**
15mm M5 Screw**BOA (x4)**
M5 Nylock Nut**PARTS REQUIRED**

Parts shown at 10% of Actual Size

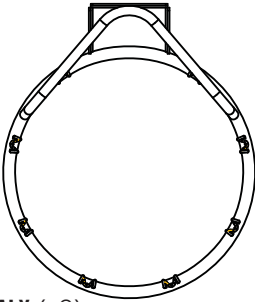
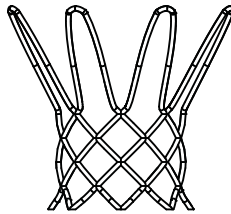
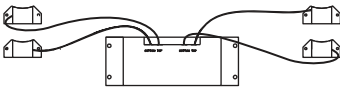
**ALX (x2)**
Rim**AKZ (x2)**
Net**BLQ (x1)**
Electronic Scoreboard

Part shown at 5% of Actual Size

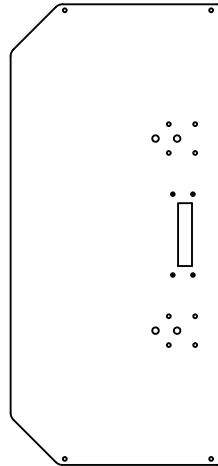
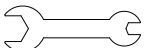
**AJI (x1)**
Backboard**TOOLS REQUIRED****9/16" Wrench****Allen Key**



TOOLS AND HARDWARE REQUIRED FOR THIS PAGE

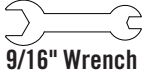

9/16" Wrench

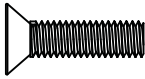

BNZ (x4)



BOA (x4)



AAP (x8)



SEC

1.1

Remove and discard the plastic shield from the **Electronic Scoreboard (BLQ)**. Attach the **Electronic Scoreboard** to the **Backboard (AJI)** with the hardware shown.

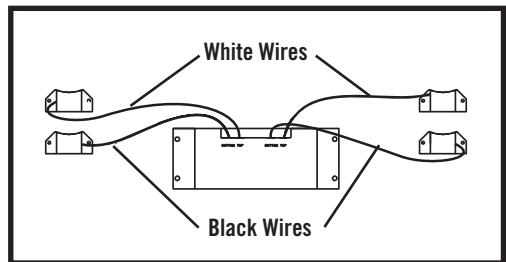
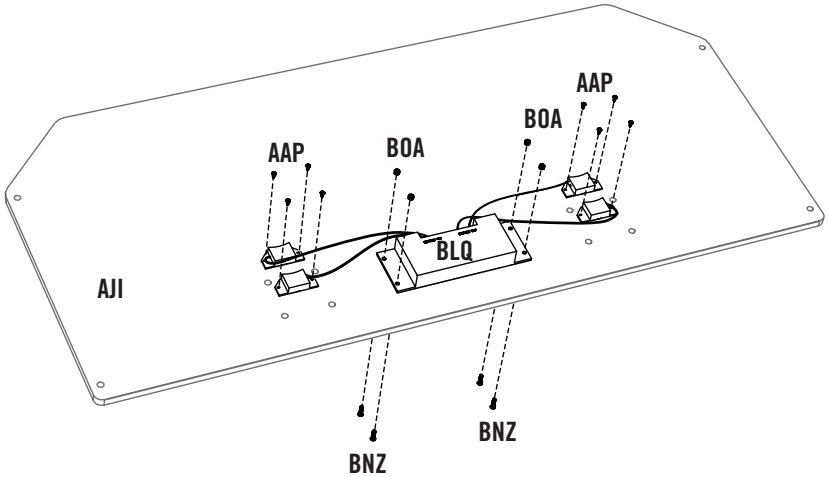

Note: Make sure to orient the digital display right side up, and attach the sensors with white wires to the top positions and the black wires to the bottom positions as shown.



TOOLS AND HARDWARE REQUIRED FOR THIS PAGE

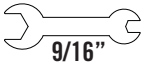

9/16"

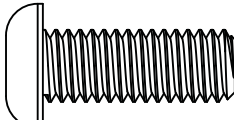

BMJ (x8)

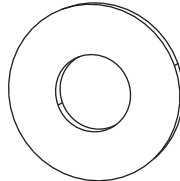

AAF (x8)



BKJ (x8)

SEC

1.2

Attach a **Rim (ALX)** to the **Backboard (AJI)** with the hardware shown.

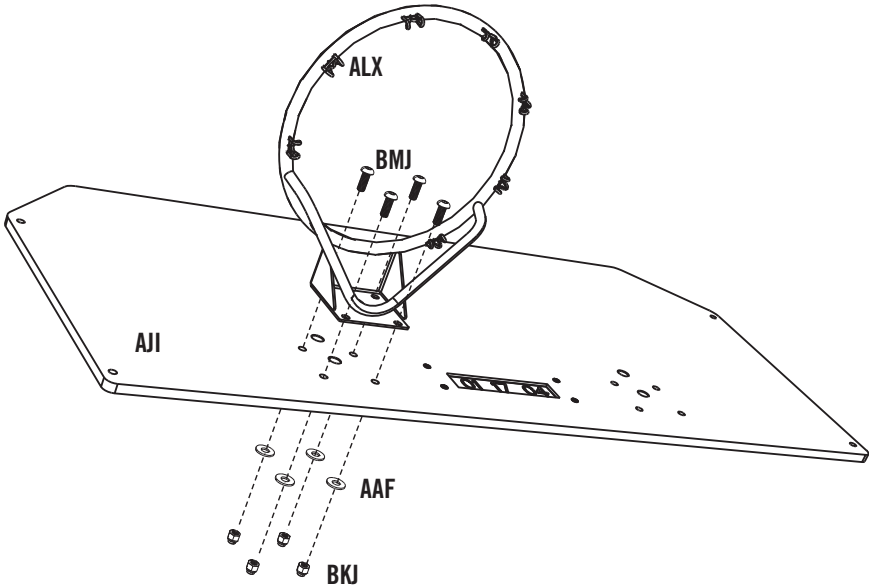

WARNING

Do not overtighten the Cap Nut. If the end of the Bolt breaks through the plastic cap, call our Customer Service Department. Exposed threads on the end of the Bolt may cause serious injuries.



Note: Repeat this step to assemble the other Rim to the Backboard.



TOOLS AND HARDWARE REQUIRED FOR THIS PAGE

NO TOOLS OR HARDWARE REQUIRED FOR THIS PAGE

SEC

1.3

Attach the **Nets (AKZ)** to the **Rims (ALX)** as shown. Then set the Backboard and Rim Assembly aside until later in the assembly process.

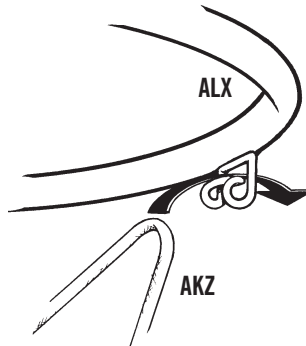

SEC 2 REAR FRAME ASSEMBLY

HARDWARE REQUIRED

Hardware shown at Actual Size

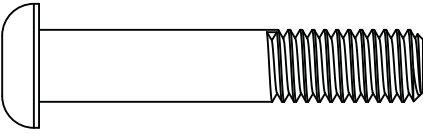

BML (x3)
3/8" x 2" Button Head Cap Screw



BKJ (x11)
3/8" Cap Nut

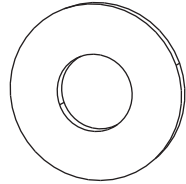

AAF (x2)
3/8" Washer

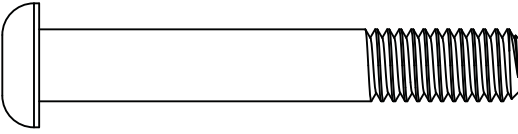

BMK (x2)
3/8" x 2 1/2" Button Head Cap Screw

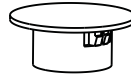

BOB (x4)
3/8" Plug

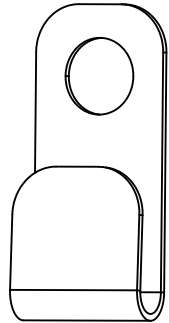

BMN (x2)
Retaining Hook

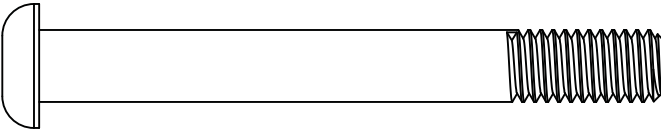

BMM (x5)
3/8" x 3 1/4" Button Head Cap Screw

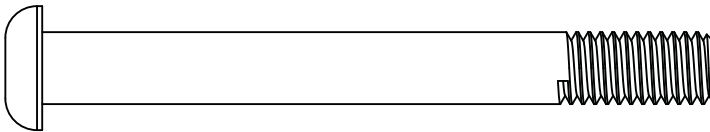

BOC (x1)
3/8" x 3 1/2" Socket Button Head Cap Screw

PARTS REQUIRED

Parts shown at 10% of Actual Size

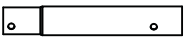

BME (x2)
Height Spacer



BLT (x2)
Fold-up Plate

SEC 2 REAR FRAME ASSEMBLY

PARTS REQUIRED

Parts shown at 5% of Actual Size

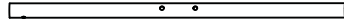
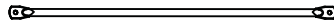
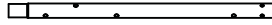
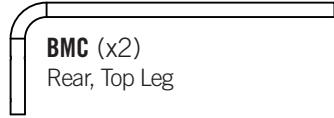
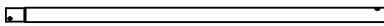
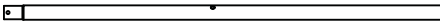
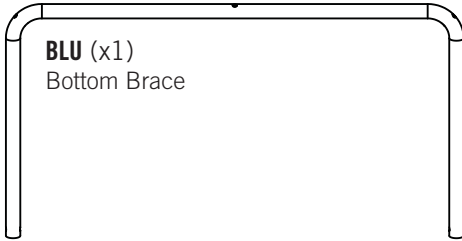

TOOLS REQUIRED

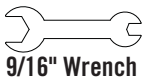



TOOLS AND HARDWARE REQUIRED FOR THIS PAGE

NO TOOLS OR HARDWARE REQUIRED FOR THIS PAGE

SEC

2.1

If the system will be placed under a ceiling that is at least 7 feet 6 inches tall, press down on the push button on the **Rear, Middle Leg (BMB)** and insert the swaged end of the **Rear, Middle Leg (BMB)** into the **Height Spacer (BME)** as shown. If the system will be placed under a ceiling that is 7 feet tall, do not perform this step.

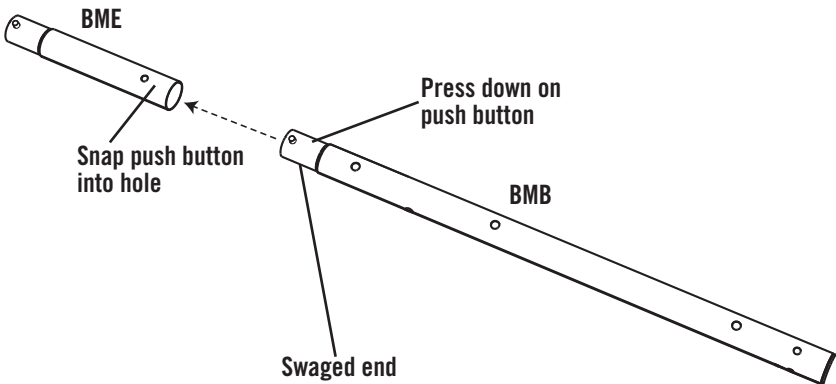

Note: Not all push buttons on Rear Frame Assembly will line up with each other.



Note: Measure the height of the ceiling to determine whether or not to perform this step.



TOOLS AND HARDWARE REQUIRED FOR THIS PAGE

NO TOOLS OR HARDWARE REQUIRED FOR THIS PAGE

SEC

2.2

Press down on the push button on the **Height Spacer (BME)** (or the **Rear, Middle Leg (BMB)** if step 2.2 was not performed) and insert the swaged end of the **Rear Leg Assembly** into the **Rear, Top Leg (BMC)** until the push button snaps into the hole indicated.

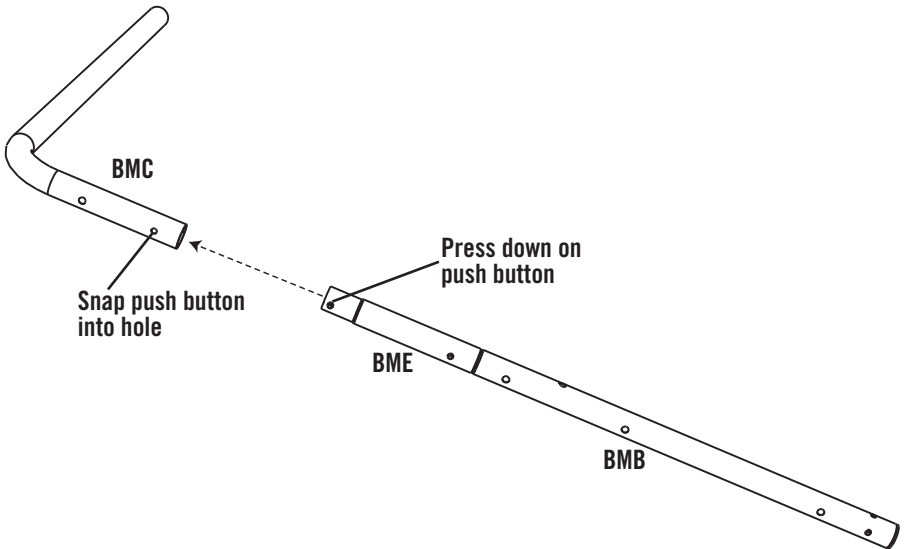

Note: Repeat steps 2.1 through 2.3 to assemble the other Rear Leg Assembly.



TOOLS AND HARDWARE REQUIRED FOR THIS PAGE

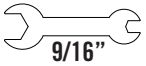

9/16"

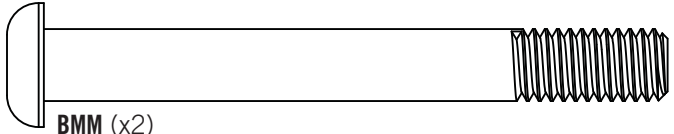

BMM (x2)



BKJ (x2)

SEC

2.3

Attach the **Bottom Brace (BLU)** to the **Rear Bottom Legs (BMA)** with the hardware shown. Make sure the hole in the center of the Bottom Brace is perpendicular to the ground as pictured. Only fingertighten the **3/8" Cap Nuts (BKJ)** until instructed to tighten all hardware later in the assembly.

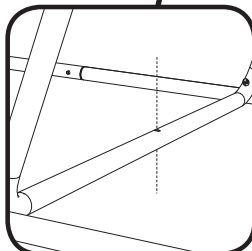
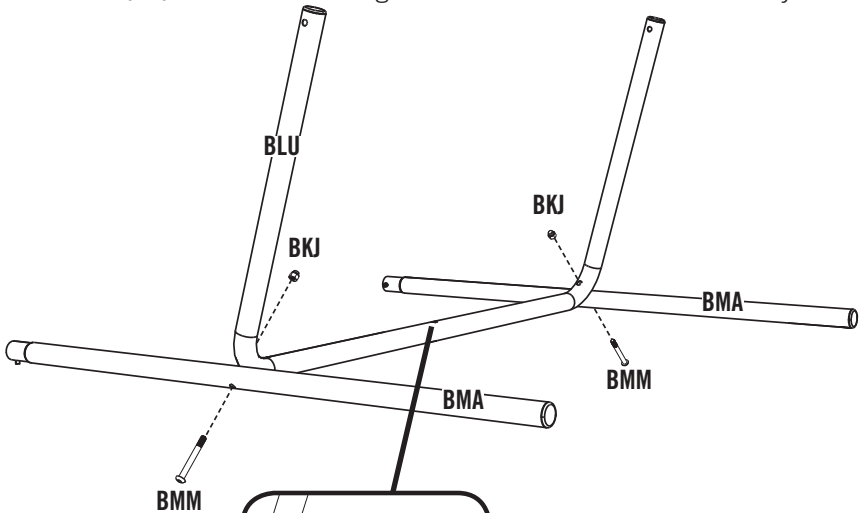

Bottom Brace Alignment



WARNING

Do not overtighten the Cap Nut.



Note: If it becomes difficult to line up the bolts with their appropriate holes, loosen the hardware until it is fingertight, then tighten all hardware at the end of the assembly.



TOOLS AND HARDWARE REQUIRED FOR THIS PAGE

NO TOOLS OR HARDWARE REQUIRED FOR THIS PAGE

SEC

2.4

Attach the **Rear Bottom Legs (BMA)** to the Rear Top Leg Assemblies as shown. Press down on the push button on the Rear, Bottom Leg and insert the swaged end of the Rear, Bottom Leg into the **Rear, Middle Leg (BMB)** until the push button snaps into the hole indicated. Make sure the assembly resembles the Side View below before moving on to the next step.

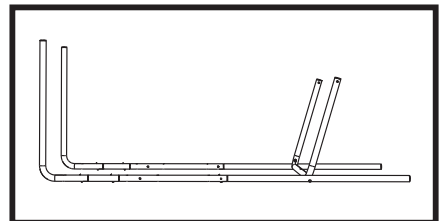
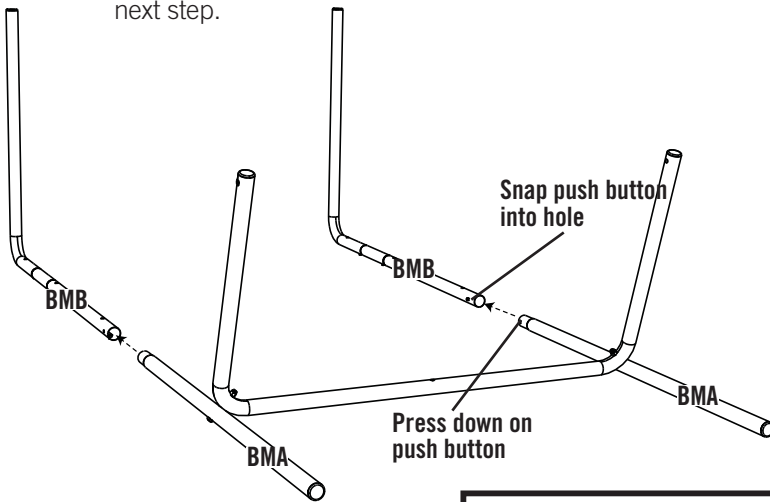

Side View



Note: When assembled correctly, the lowest push button on the Left Leg will face a different direction than the lowest push button on the Right Leg.



TOOLS AND HARDWARE REQUIRED FOR THIS PAGE

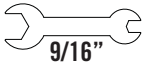

9/16"

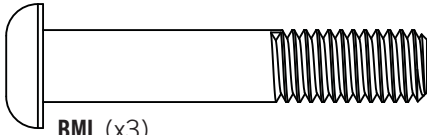

BML (x3)



BKJ (x3)

SEC

2.5

Attach the **Rear Cross Braces (BLZ)** to the Rear Leg Assemblies and the **Bottom Brace (BLU)** with the hardware shown. Only fingertighten the hardware until instructed to tighten all hardware later in the assembly.

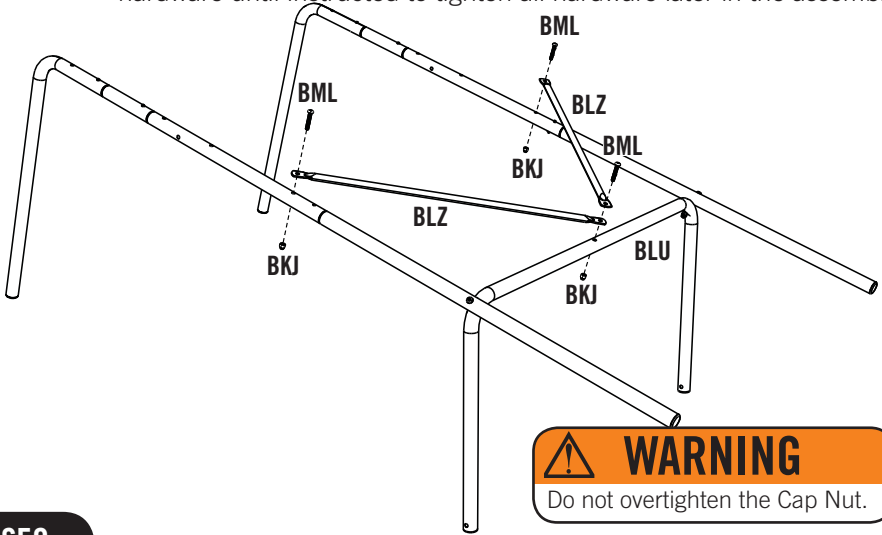

WARNING

Do not overtighten the Cap Nut.

SEC

2.6

Press down on the push button on the **Upper, Middle Leg (BMF)** and insert the swaged end of the **Upper, Middle Leg (BLY)** into the **Middle Leg (BLY)** until the push button snaps into the hole indicated.

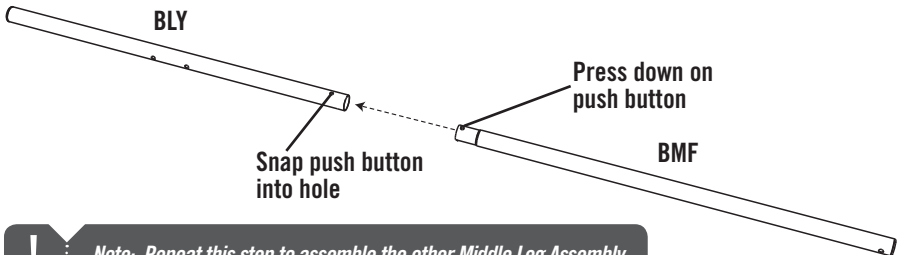

Note: Repeat this step to assemble the other Middle Leg Assembly.



TOOLS AND HARDWARE REQUIRED FOR THIS PAGE

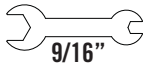

9/16"



BKJ (x2)

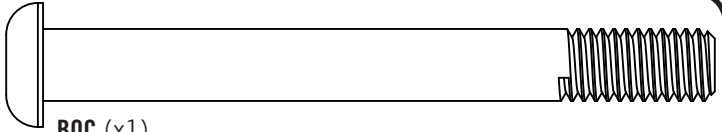

BOC (x1)

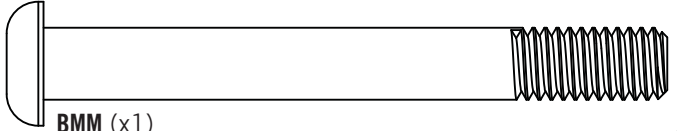

BMM (x1)

SEC

2.7

Attach a Middle Leg Assembly and the **Fold-up Plates (BLT)** to the Rear Leg Assembly and the **Bottom Brace (BLU)** with the hardware shown. Only fingertighten the hardware until instructed to tighten it later in the assembly.

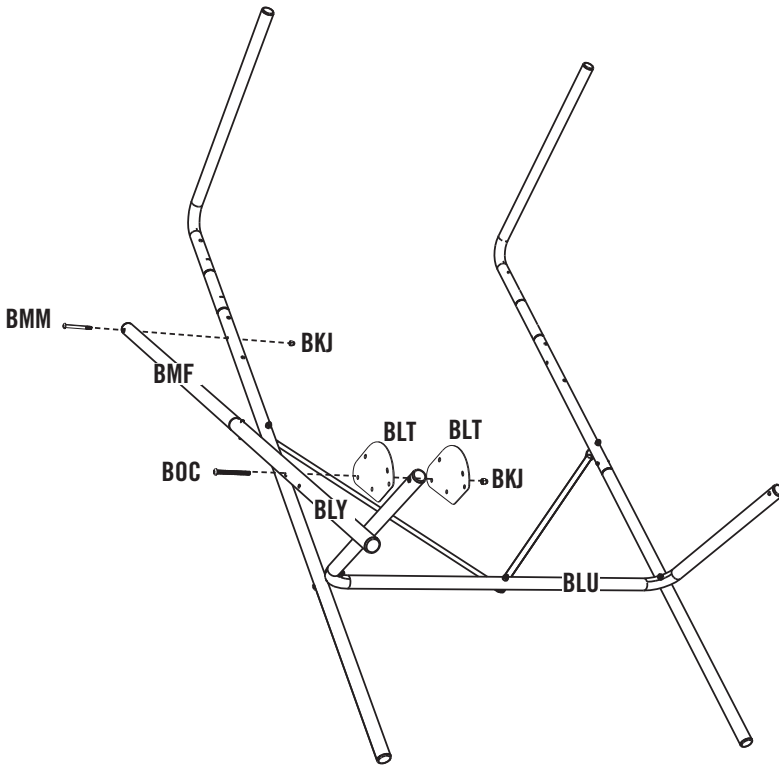

WARNING

Do not overtighten the Cap Nut.



TOOLS AND HARDWARE REQUIRED FOR THIS PAGE

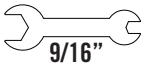

9/16"

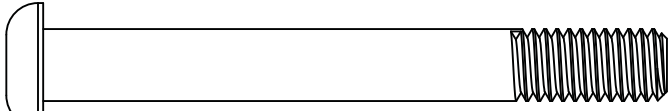

BMM (x2)



BKJ (x2)

SEC

2.8

Attach the other Middle Leg Assembly to the Rear Leg Assembly and the **Bottom Brace (BLU)** with the hardware shown.

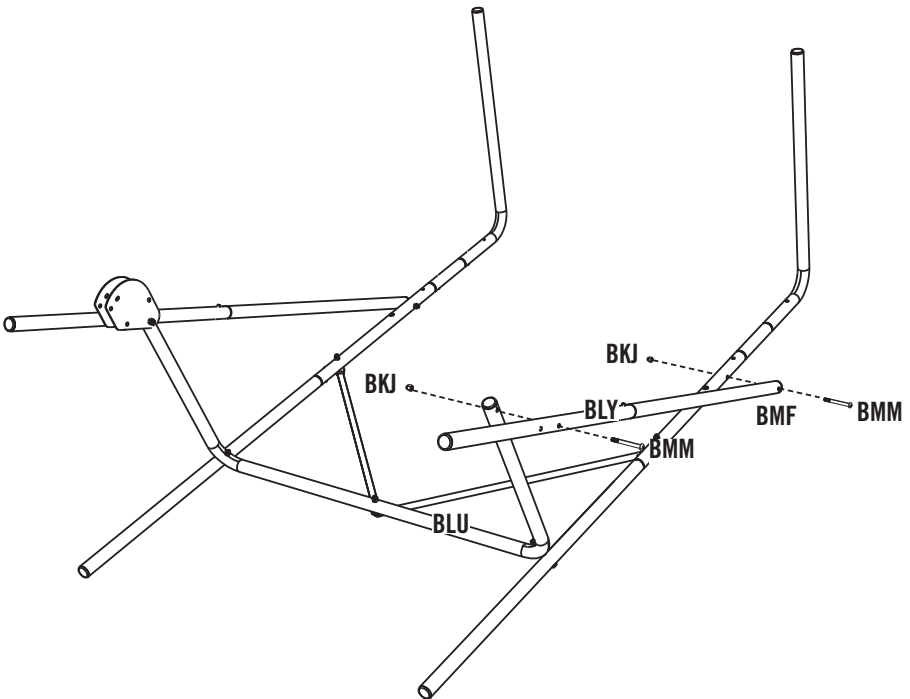

WARNING

Do not overtighten the Cap Nut.



Note: Tighten all hardware now.



TOOLS AND HARDWARE REQUIRED FOR THIS PAGE

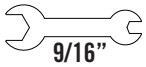

9/16"

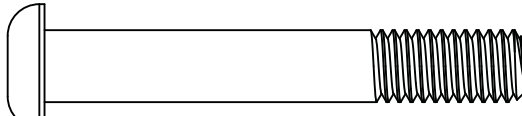

BMK (x2)



AAF (x2)

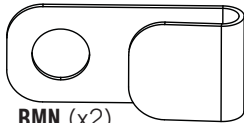

BMN (x2)

(Not to scale)



BKJ (x2)

SEC

2.9

Attach the Backboard Assembly to the **Rear, Top Legs (BMC)** with the hardware shown.

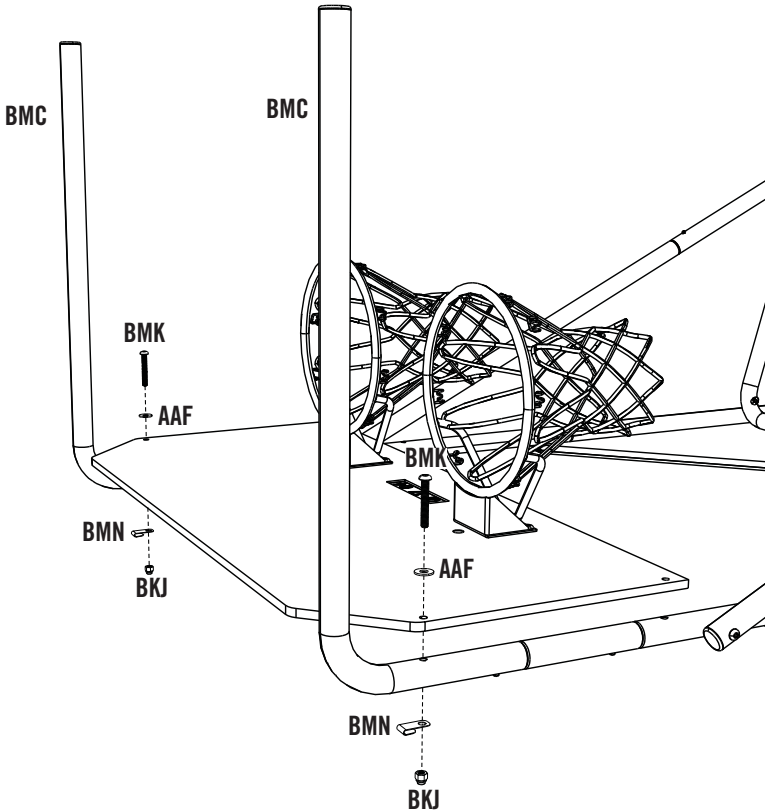

WARNING

Do not overtighten the Cap Nut.



TOOLS AND HARDWARE REQUIRED FOR THIS PAGE

NO TOOLS REQUIRED FOR THIS PAGE

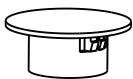

BOB (x4)

SEC

2.10

With the help of another adult, rotate the Rear Frame Assembly upright as shown.

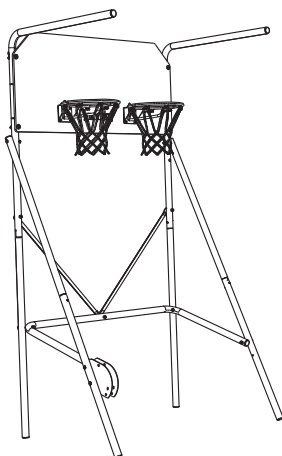

SEC

2.11

Insert 3/8" Plugs (BOB) into the holes indicated.

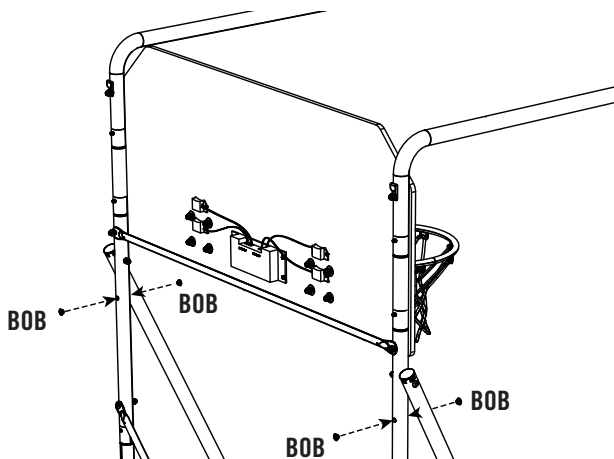

SEC 3 FRONT FRAME ASSEMBLY

HARDWARE REQUIRED

Hardware shown at Actual Size

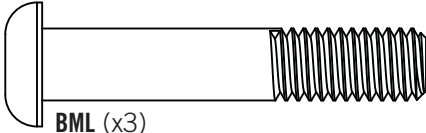

BML (x3)
3/8" x 2" Button Head Cap Screw

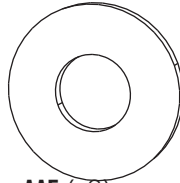

AAF (x2)
3/8" Washer



BKJ (x7)
3/8" Cap Nut

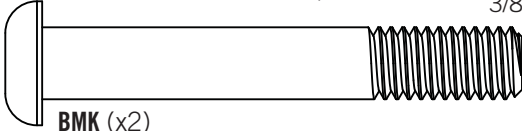

BMK (x2)
3/8" x 2 1/2" Button Head Cap Screw

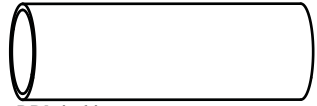

BPI (x1)
1 1/2" x 1/2" Spacer

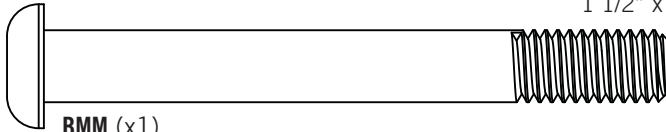

BMM (x1)
3/8" x 3 1/4" Button Head Cap Screw

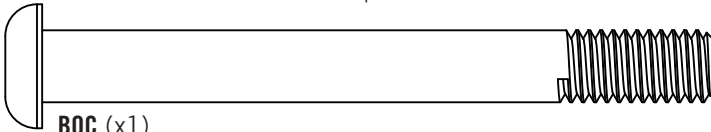

BOC (x1)
3/8" x 3 1/2" Socket Button Head Cap Screw

PARTS REQUIRED

Parts shown at 5% of Actual Size

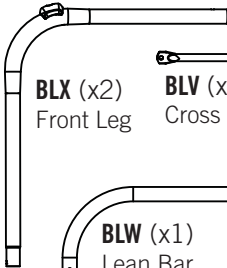

BLX (x2)
Front Leg

BLW (x1)
Lean Bar

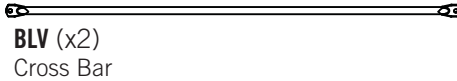

BLV (x2)
Cross Bar

Part shown at 10% of Actual Size



BLR (x1)
Electronic Power Source

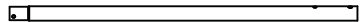

BOF (x1)
Side Rail

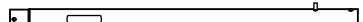

BMD (x1)
Side Rail with Push Button

TOOLS REQUIRED

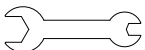

9/16" Wrench



Allen Key



TOOLS AND HARDWARE REQUIRED FOR THIS PAGE

NO TOOLS OR HARDWARE REQUIRED FOR THIS PAGE

SEC

3.1

Press down on the push button on the **Side Rail with Push Button (BMD)** and insert the swaged end of the Side Rail into the **Front Leg (BLX)** until the push button snaps into the hole indicated.

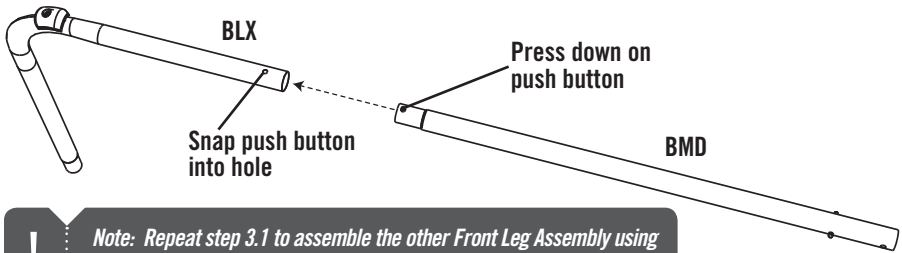

Note: Repeat step 3.1 to assemble the other Front Leg Assembly using the Side Rail (BOF) in place of the Side Rail with Push Button.

SEC

3.2

Slide the **Lean Bar (BLW)** through the sleeve of the **Ball Return Net (BLS)** as shown. If the **Height Spacers (BME)** were not attached to the Rear Frame Assembly in step 2.2, slide the Lean Bar through the lower sleeve in the Ball Return Net.

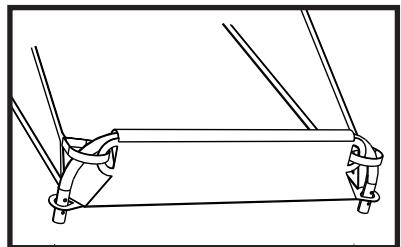
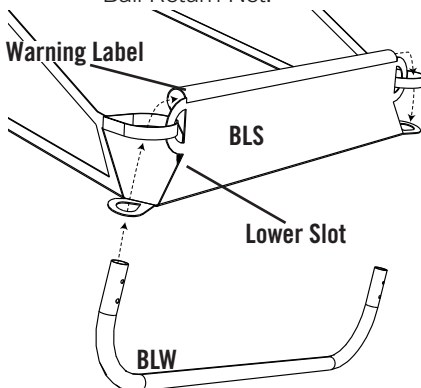

Lean Bar in sleeve of Ball Return Net



Note: Make sure the Warning Label on the Ball Return Net is facing up.



TOOLS AND HARDWARE REQUIRED FOR THIS PAGE

NO TOOLS OR HARDWARE REQUIRED FOR THIS PAGE

SEC

3.3

Press down on the push buttons on the Front Leg Assemblies and insert the swaged ends of the Front Leg Assemblies into the **Lean Bar (BLW)** until the push buttons snap into the holes indicated. Clip the Straps together through the loops on both sides of the Ball Return Net near the sleeve.

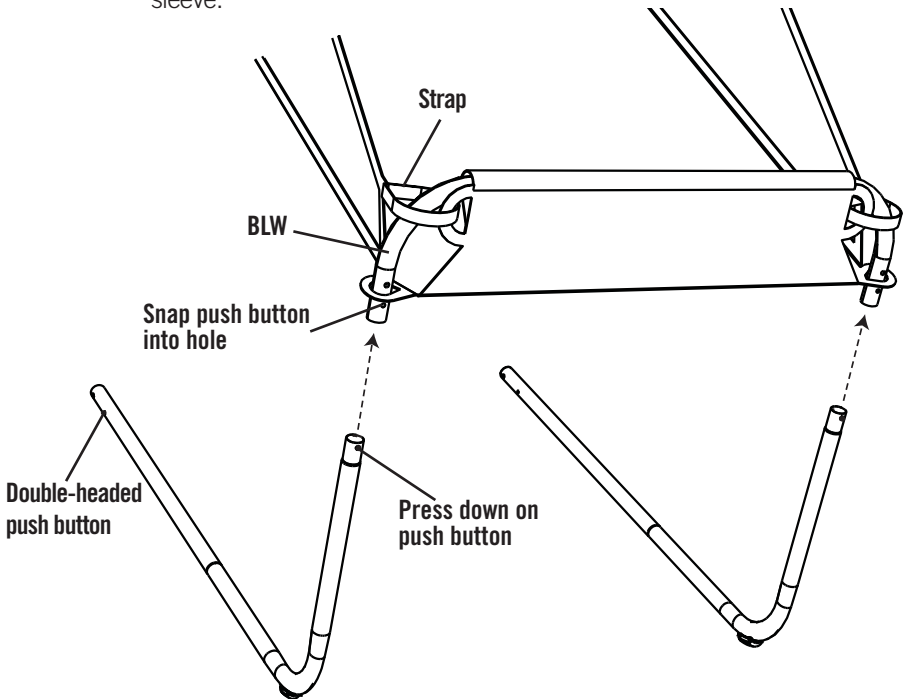

Note: Attach the Front Leg Assembly that has a double-headed push button on the left side of the system as shown.



TOOLS AND HARDWARE REQUIRED FOR THIS PAGE

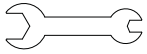

9/16"

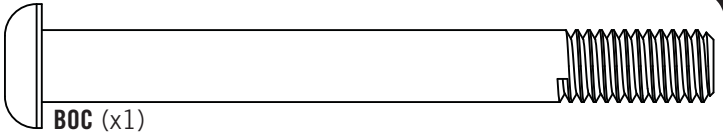

BOC (x1)

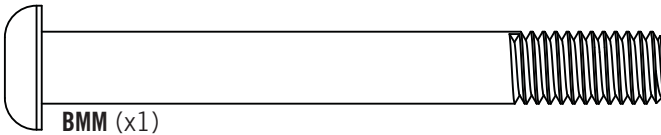

BMM (x1)



BKJ (x2)

SEC

3.4

Attach the Front Frame Assembly to the Rear Frame Assembly with the hardware shown. Press down on the double headed push button on the Front Leg Assembly on the left side of the system and insert the button into the holes indicated on the **Fold-up Plate (BLT)**.

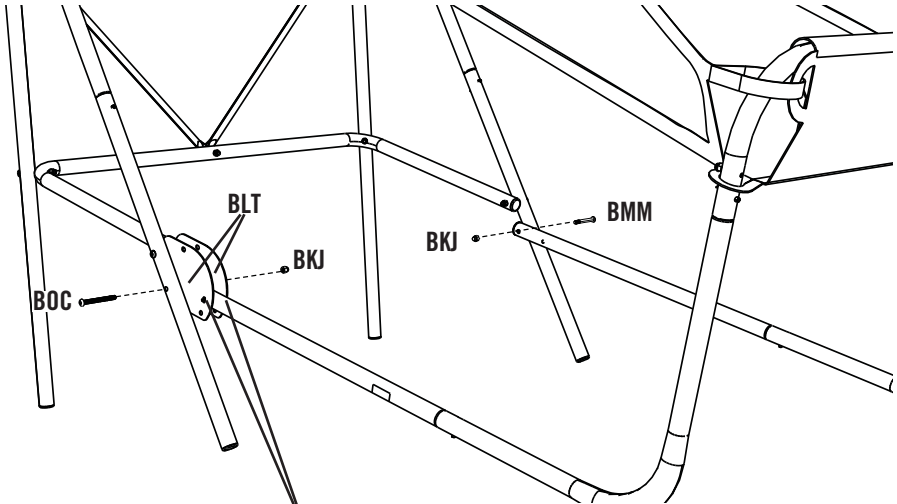

Snap double-headed push button into holes



WARNING

Do not overtighten the Cap Nut.



TOOLS AND HARDWARE REQUIRED FOR THIS PAGE

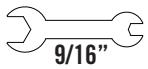

9/16"

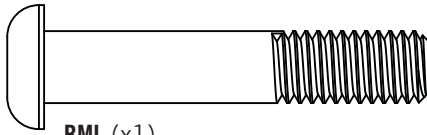

BML (x1)



BKJ (x1)

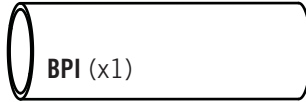

BPI (x1)

SEC

3.5

Slide the $\frac{3}{8}$ " x 2" Button Head Cap Screw (BML) into the Fold-up Plate and through the $1\frac{1}{2}$ " x $\frac{1}{2}$ " Spacer (BPI). Attach with the hardware shown.

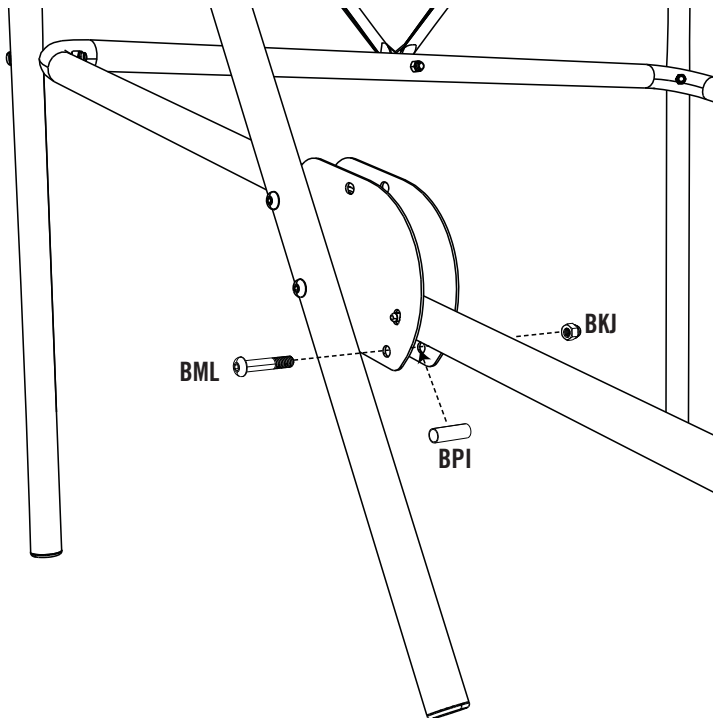

WARNING

Do not overtighten the Cap Nut.



TOOLS AND HARDWARE REQUIRED FOR THIS PAGE

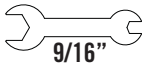

9/16"

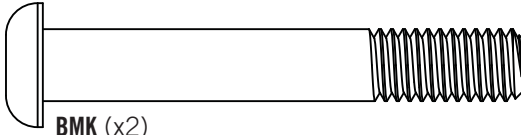
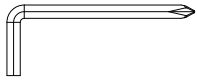

BMK (x2)



BKJ (x2)



AAF (x2)

SEC

3.6

Slide the **Ball Return Net (BLS)** over the **Rear, Top Legs (BMC)**. Hook the Upper Straps of the Ball Return Net under the **Retaining Hooks (BMN)** as shown.

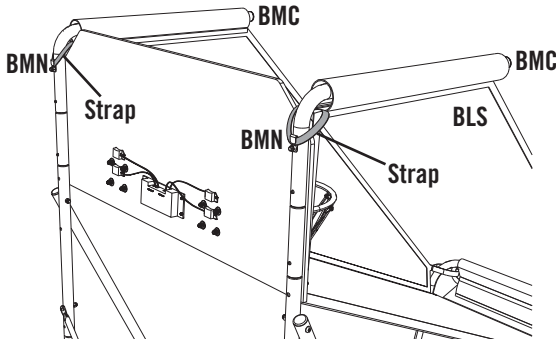

SEC

3.7

Slide a **Cross Bar (BLV)** into the sleeve of the **Ball Return Net (BLS)**. Secure the Cross Bar to the Rear Frame Assembly as shown, then connect the Lower Straps of the Ball Return Net as shown.

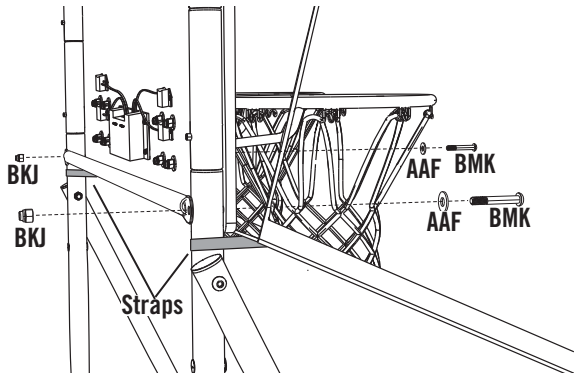
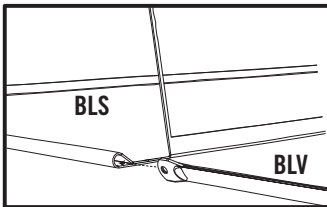

WARNING

Do not overtighten the Cap Nut.



TOOLS AND HARDWARE REQUIRED FOR THIS PAGE

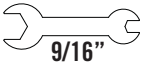

9/16"

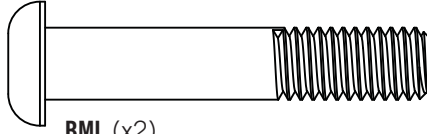

BML (x2)



BKJ (x2)

SEC

3.8

Position the other **Cross Bar (BLV)** on the inside of the **Ball Return Net (BLS)** as shown. Then attach the Cross Bar to the Front Frame Assembly with the hardware shown. Tighten any loose hardware now.

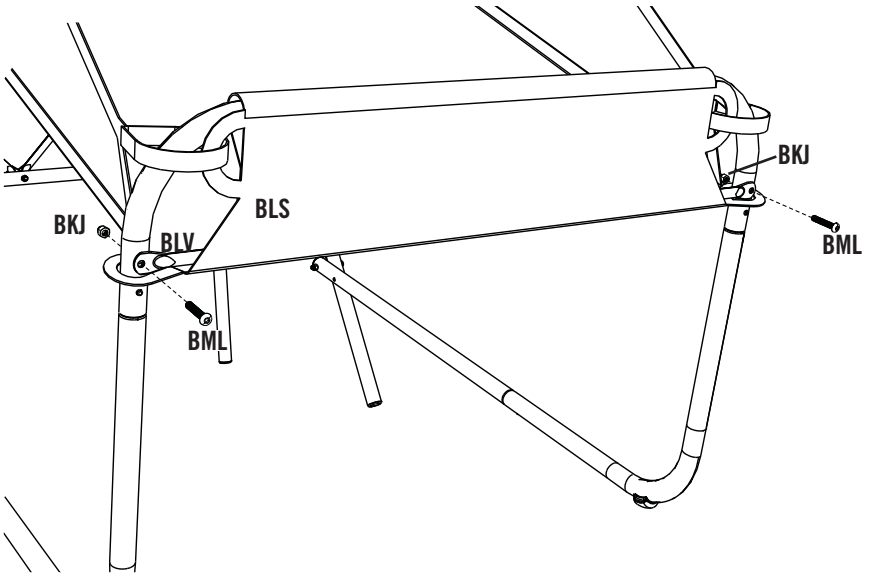



TOOLS AND HARDWARE REQUIRED FOR THIS PAGE

NO TOOLS OR HARDWARE REQUIRED FOR THIS PAGE

SEC

3.9

Connect the **Electronic Power Source (BLR)** to the **Electronic Scoreboard (BLQ)** as shown. The Scoreboard can also be powered by four AA batteries (not included).

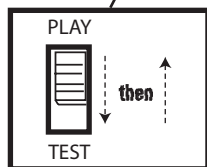
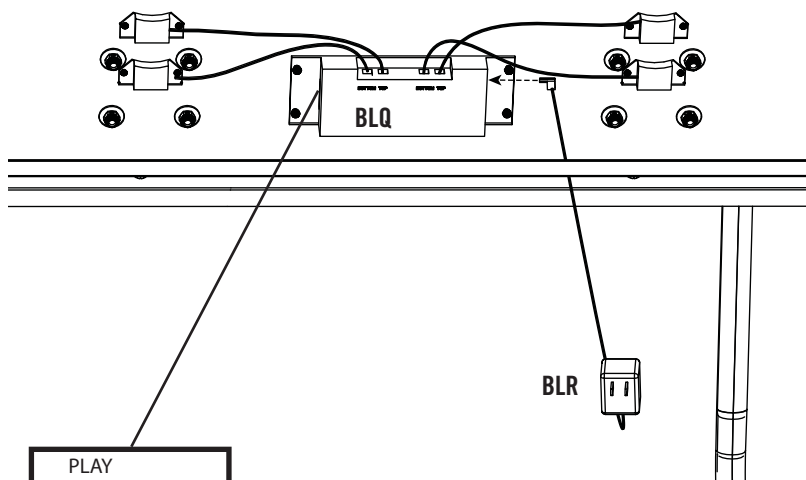

Test Switch



Note: To reset the high score, toggle the Test Switch to the TEST position, then back to PLAY. The unit must be turned on to reset scores.



Note: The battery compartment is located on the back of the Electronic Scoreboard. To install the batteries, a small Phillips screwdriver will be required.

GAME PLAY

How to Play:

Each game consists of a possible 3 rounds.

Round 1: In the first round, each player has 30 seconds to reach 30 points and move on to round 2. Each basket is worth 2 points for the first 20 seconds, and 3 points for the last 10 seconds. Players who do not score the required points will not advance to the next round.

Round 2: Advancing players are given 15 additional seconds to reach 60 points and move on to the third and final round. Every shot is now worth 3 points. Players who do not have 60 points when the buzzer sounds will not advance to round 3.

Round 3: Each shot is worth 3 points. When the buzzer sounds at the end of round 3, the highest score wins!

The Electronic Scoreboard:

The Scoreboard display consists of three parts--Player 1's score, the Timer, and Player 2's score.

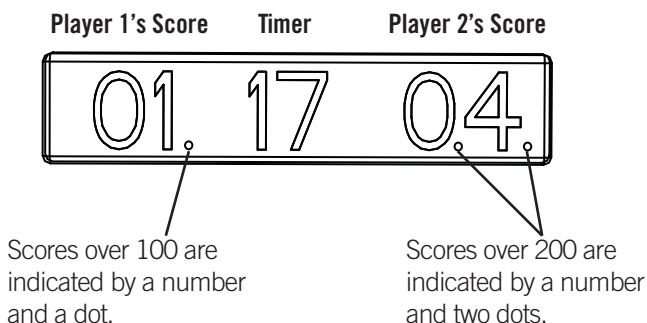

When the system is not being played, the Electronic Scoreboard displays the High Score. To reset the high score, see Sec 3.9 of these instructions.

If a Warning Label or Sticker is illegible, destroyed or removed, contact Customer Service for a replacement.

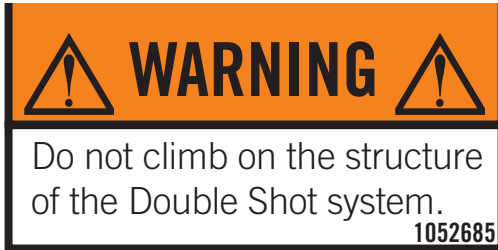

The Warning Label is located on the Ball Return Net at the front of the system.



The Pinch Warning stickers are located on the Fold-up Plates on the left side of the system near the bottom.

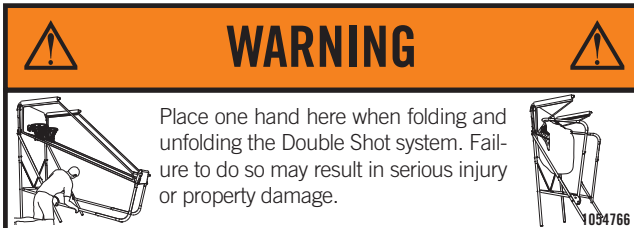

The System Fold Up Warning sticker is located on the Side Rail with Push Button on the left side of the system near the bottom.

**ENHANCE YOUR LIFETIME® PURCHASE BY ADDING
ACCESSORIES OR OTHER GREAT PRODUCTS:**

To purchase accessories or other Lifetime Products, visit us at:

www.lifetime.com

Or call: 1-800-424-3865

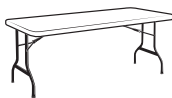
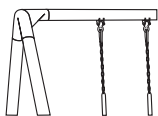

WARRANTY INFORMATION

LIFETIME BASKETBALL EQUIPMENT

90-DAY LIMITED FACTORY WARRANTY

THE MANUFACTURER RESERVES THE RIGHT TO MAKE SUBSTITUTIONS TO WARRANTY CLAIMS IF PARTS ARE UNAVAILABLE OR OBSOLETE.

1. Lifetime basketball systems are warranted to the original purchaser to be free from defects in material or workmanship for a period of ninety days from the date of original retail purchase. The word "defects" is defined as imperfections that impair the use of the product. Defects resulting from misuse, abuse or negligence will void this warranty. This warranty does not cover defects due to improper installation, alteration or accident. This warranty does not cover damage caused by vandalism, rusting, "acts of nature" or any other event beyond the control of the manufacturer.
2. This warranty is nontransferable and is expressly limited to the repair or replacement of defective basketball equipment. If the equipment is defective within the terms of this warranty, Lifetime Products, Inc. will repair or replace defective parts at no cost to the purchaser. Shipping charges to and from the factory are not covered and are the responsibility of the purchaser. Labor charges and related expenses for removal, installation or replacement of the basketball system or its components are not covered under this warranty.
3. This warranty does not cover scratching or scuffing of the product that may result from normal usage. In addition, defects resulting from intentional damage, negligence, unreasonable use or hanging from the net or rim will void this warranty.
4. Liability for incidental or consequential damages is excluded to the extent permitted by law. While every attempt is made to embody the highest degree of safety in all equipment, freedom from injury cannot be guaranteed. The user assumes all risk of injury resulting from the use of this product. All merchandise is sold on this condition, and no representative of the company may waive or change this policy.
5. This product is not intended for institutional or commercial use; Lifetime Products, Inc. does not assume any liability for such use. Institutional or commercial use will void the warranty.
6. This warranty is expressly in lieu of all other warranties, expressed or implied, including warranties of merchantability or fitness for use to the extent permitted by Federal and state law. Neither Lifetime Products, Inc., nor any representative assumes any other liability in connection with this product. This warranty gives you specific legal rights, and you may also have other rights which vary from state to state.

ALL WARRANTY CLAIMS MUST BE ACCOMPANIED BY A SALES RECEIPT.

REPORT PRODUCT DEFECTS IN WRITING TO:

Lifetime Products, Inc., PO Box 160010 Clearfield, UT 84016-0010, or call (800) 225-3865

M-F 7 a.m. to 5 p.m. MST.

Call or visit our Web site for Saturday hours

Please include your dated sales receipt and photographs of damaged parts.

To register the product, visit our Web site at www.lifetime.com