







STYLE NO. MS1071 – ESPRESSO FINISH
MS1072 – WHITE FINISH



SOUTHERN ENTERPRISES INC.

**SLIDING-DOOR WINDOW PANE
MEDIA CABINET**

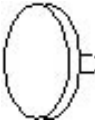
RELAX...If you can follow a few easy, step-by-step directions
in order .YOU CAN ASSEMBLE THIS ITEM.

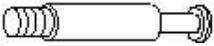
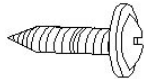
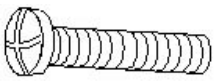
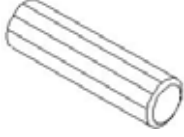
PLEASE FIND HARDWARE IN RED POLYBAG BEFORE DISCARDING PACKING MATERIAL.

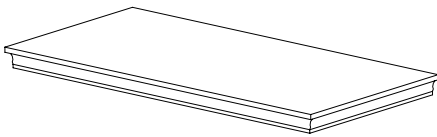
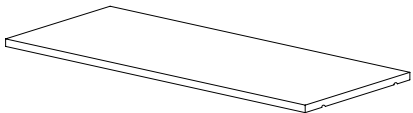
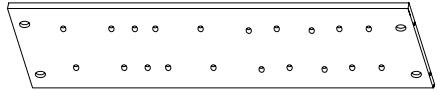
HARDWARE LIST			
(1) CAM-LOCKS	8PCS	(5) T-BOLTS	4PCS
			
(2) COVERS	8PCS	(6) SHELF SUPPORTS	20PCS
			
(3) CAM-BOLTS	8PCS	(7) WOOD SCREWS	32PCS
		 Ø2.6 x 10mm	
(4) MACHINE SCREWS Ø1/4" x 2-1/4"	4PCS	(8) WOOD DOWELS	4PCS
		 Ø8 x 30mm	

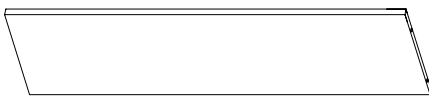
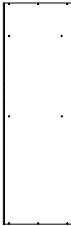
PARTS LIST			
(A) TOP PANEL	1PC	(F) ADJUSTABLE SHELVES	5PCS
			
(B) LEFT SIDE PANEL	1PC	(G) RIGHT BACK PANEL	1PC
			
(C) RIGHT SIDE PANEL	1PC	(H) LEFT BACK PANEL	1PC
			

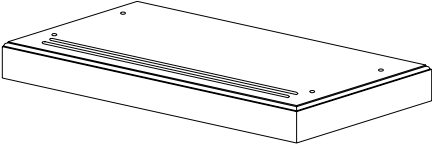
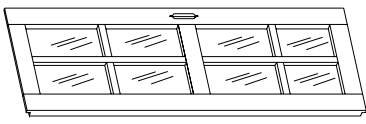
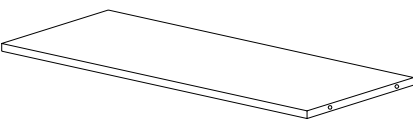
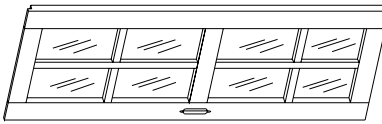
<p>(D) BASE 1PC</p> 	<p>(I) LEFT DOOR 1PC</p> 
<p>(E) FIXED SHELVES 2PCS</p> 	<p>(J) RIGHT DOOR 1PC</p> 

ASSEMBLY INSTRUCTION

1. SELECT A SMOOTH, SOFT SURFACE TO PREVENT SCRATCHING FINISH. YOU MAY NEED A PHILLIP SCREWDRIVER.
2. PLACE LEFT SIDE PANEL (B) SMOOTH SIDE ON FLAT SURFACE, THEN SCREW 2 CAM-BOLTS (3) INTO PRETHREADED INSERT HOLES ON SIDE PANEL (B) UNTIL STOP. (PLEASE DO NOT OVERTIGHTEN CAM-BOLTS). ALSO PUSH 2 WOOD DOWELS (8) INTO LARGE OPENING HOLES INTO LEFT SIDE PANEL (B). REPEAT SAME PROCEDURE FOR RIGHT SIDE PANEL (C). AS FIGURE 1 SHOWN.
3. NOW, INSERT CAM-BOLTS (3), WOOD DOWELS (8) INTO PREDRILLED HOLES ON ENDS OF FIXED SHELVES (E) AND FIT INTO CORRESPONDING HOLES ON INSIDE OF LEFT AND RIGHT SIDE PANELS (B, C). INSERT CAM-LOCKS (1) INTO BIG HOLES ON INSIDE OF LEFT AND RIGHT SIDE PANELS (B, C) WITH SLOT FOR SCREWDRIVER FACING OUTWARD. ROTATE CAM-LOCKS (1) CLOCKWISE TO SECURE CAM-BOLTS (3). PUSH COVERS (2) INTO CAM-LOCKS (1). AS FIGURE 1 SHOWN.
4. INSERT T-BOLTS (5) INTO PREDRILLED HOLES ON INSIDE OF LEFT AND RIGHT SIDE PANELS (B, C). INSERT MACHINE SCREWS (4) THROUGH PREDRILLED HOLES ON UNDERSIDE OF BASE (D) AND TIGHTEN INTO T-BOLTS (5). PLEASE NOTE THAT IF SCREWS DO NOT TIGHTEN, ROTATE T-BOLTS (5) SO THAT THREADS OF T-BOLTS (5) FACING MACHINE SCREWS (4). AS FIGURE 1 SHOWN.

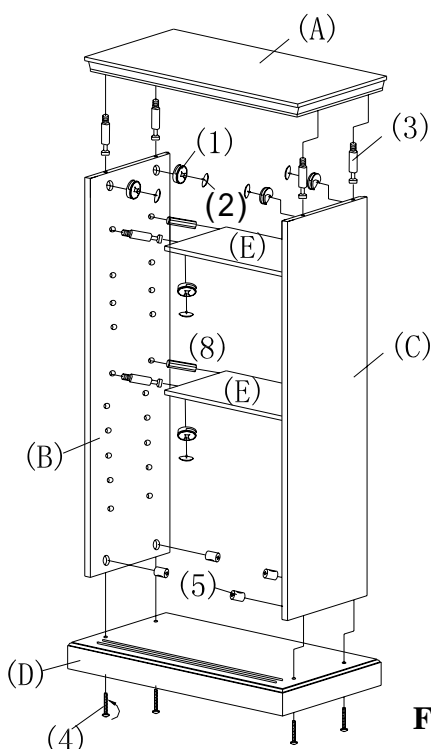

FIGURE 1

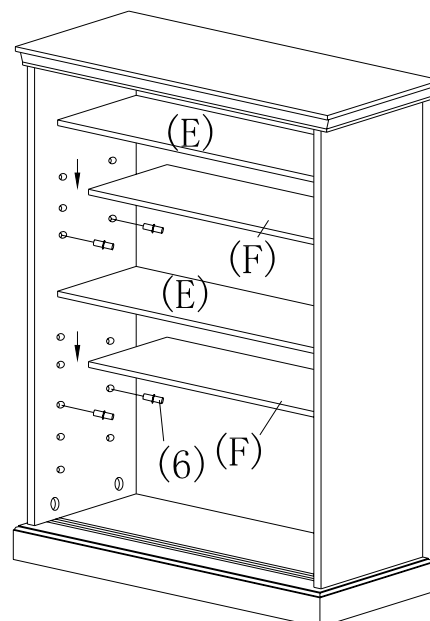
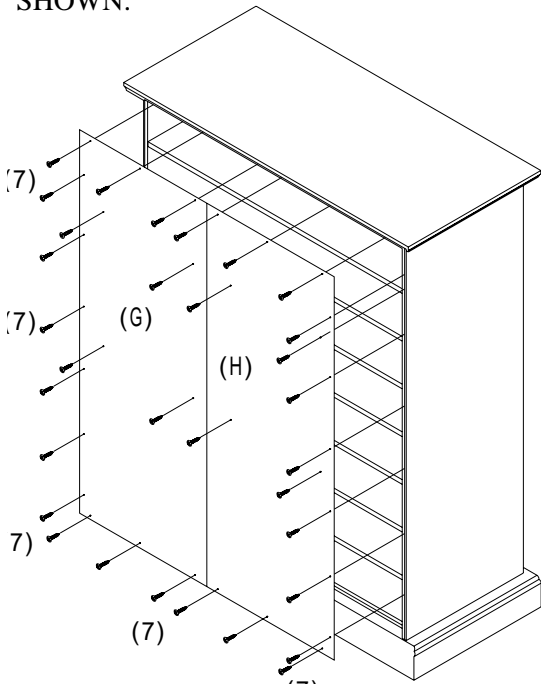

FIGURE 2

5. TIGHTEN CAM-BOLTS (3) INTO THREADED HOLES ON UNDERSIDE OF TOP PANEL (A) AND FIT INTO CORRESPONDING HOLES ON TOP EDGES OF LEFT AND RIGHT SIDE PANELS (B, C). INSERT CAM-LOCKS (1) INTO BIG HOLES ON INSIDE OF LEFT AND RIGHT SIDE PANELS (B, C) WITH SLOT FOR SCREWDRIVER FACING OUTWARD. ROTATE CAM-LOCKS (1) CLOCKWISE TO SECURE CAM-BOLTS (3). PUSH COVERS (2) INTO CAM-LOCKS (1). AS FIGURE 1 SHOWN.
6. FIT SHELF SUPPORTS (6) INTO PREDRILLED HOLES ON INSIDE OF LEFT AND RIGHT SIDE PANELS (B, C). PUT ADJUSTABLE SHELVES (F) ON EACH SHELF SUPPORTS (6) MATCHING THE POSITION OF GROOVES ON ADJUSTABLE SHELVES (F). AS FIGURE 2 SHOWN.
7. ATTACH LEFT AND RIGHT BACK PANELS (H, G) INTO SLOTS OF PARTS (A, B, C, D). INSERT WOOD SCREWS (7) THROUGH PREDRILLED HOLES ON LEFT AND RIGHT BACK PANELS (G, H) AND TIGHTEN INTO REAR EDGES OF PARTS (A, B, C, D). AS FIGURE 3 SHOWN.
8. FIT LEFT AND RIGHT DOORS (I, J) INTO GROOVES ON TOP PANEL AND BASE (A, D). AS FIGURE 4 SHOWN.



(7) **FIGURE 3**

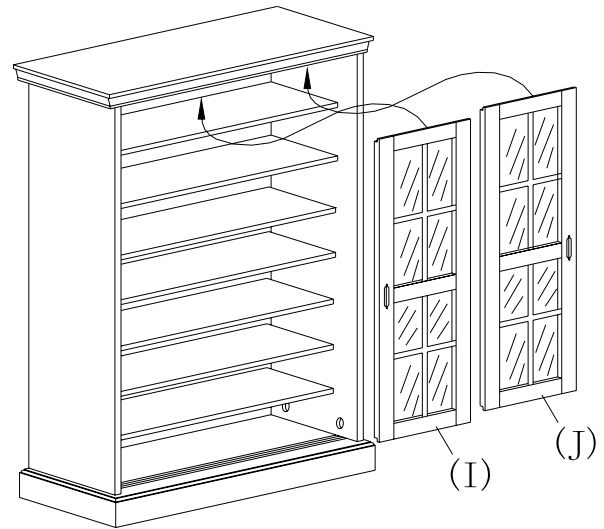

FIGURE 4

SHOWN BACK VIEW FOR ASSEMBLY PURPOSES.



READY

YOUR NEW SLIDING-DOOR WINDOW PANE MEDIA CABINET IS FINISHED AND READY TO USE.

Please count, identify and compare parts and hardware list to be sure all parts are present. It may help to divide parts and label them to correspond with part list. Extra hardware may be included. If any items are missing, please contact our parts/service department at (800) 633-5096 or in Dallas (972) 869-0111/ 9am – 4pm Mon-Fri Central time. Missing or damaged hardware and/ or parts will be replaced free of charge. WE DO NOT SELL PARTS. WE DO NOT RECOMMEND MODIFYING PRODUCT(S) AND WE ARE NOT RESPONSIBLE FOR ANY DAMAGES DUE TO PRODUCT MODIFICATION(S). If this product has not been purchased from our retail affiliates (within 9 months), we are under no obligation to provide parts or replacement merchandise. Parts will not be available for items arriving fully assembled.

"We will ship parts if available" "This is not a warranty"

PARTS REPLACEMENT FORM			
STYLE NO: MS1071/MS1072			
Customer Name	PARTS LETTER	PART DESCRIPTION	QUANTITY NEEDED
Street, City, State, Zip			
Phone#			
			
SOUTHERN ENTERPRISES INC. P.O. Box 59996 Dallas, Texas 75229			